



JDF Specification

1.6-Final

28 February 2018



CIP4 THANKS ITS PARTNER LEVEL MEMBERS



Kodak



HEIDELBERG

MULLER MARTINI



RICOH



Legal Notice

Use of this document is subject to the following conditions which are deemed accepted by any person or entity making use hereof.

Copyright Notice

Copyright © 2000–2018, International Cooperation for the Integration of Processes in Prepress, Press and Postpress (CIP4) with registered office in Zurich, Switzerland. All Rights Reserved. CIP4 hereby grants to any person or entity obtaining a copy of the Specification and associated documentation files (the “Specification”) a perpetual, worldwide, non-exclusive, fully paid-up, royalty-free copyright license to use, copy, publish, distribute, publicly display, publicly perform, and/or sublicense the Specification in whole or in part verbatim and without modification, unless otherwise expressly permitted by CIP4, subject to the following conditions. This legal notice SHALL be included in all copies containing the whole or substantial portions of the Specification. Copies of excerpts of the Specification which do not exceed five (5) pages SHALL include the following short form Copyright Notice: Copyright © 2000–2018, International Cooperation for the Integration of Processes in Prepress, Press and Postpress (CIP4) with registered office in Zurich, Switzerland.

Trademarks and Tradenames

International Cooperation for the Integration of Processes in Prepress, Press and Postpress, CIP4, Exchange Job Definition Format, XJDF, Exchange Job Messaging Format, XJMF, Job Definition Format, JDF, Job Messaging Format, JMF and the CIP4 logo are trademarks of CIP4.

Rather than put a trademark symbol in every occurrence of other trademarked names, we state that we are using the names only in an editorial fashion, and to the benefit of the trademark owner, with no intention of infringement of the trademark.

Except as contained in this legal notice or as allowed by membership in CIP4, the name of CIP4 SHALL not be used in advertising or otherwise to promote the use or other dealings in this specification without prior written authorization from CIP4.

Waiver of Liability

The JDF Specification is provided as is, without warranty of any kind, express, implied, or otherwise, including but not limited to the warranties of merchantability, fitness for a particular purpose and non infringement. In no event will CIP4 be liable for any claim, damages or other liability, whether in an action of contract, tort or otherwise, arising from, out of, or in connection with the JDF Specification or the use or other dealings in the JDF Specification.

Table of Contents

Chapter 1 Introduction	1
1.1 Further Information	1
1.2 Background on JDF	1
1.3 Conventions Used in This Specification	1
1.3.1 Document References	1
1.3.2 Text Styles	1
1.3.3 XPath Notation Used in this Specification	2
1.3.4 Modification Notes	2
1.3.5 Specification of Cardinality	3
1.3.6 Template for Narrative Description of Resources	4
1.3.7 Template for Tables that Describe Elements	4
1.4 Glossary	5
1.5 Conformance	10
1.5.1 Conformance Terminology	10
1.5.2 Conformance Requirements for JDF Entities	11
1.5.3 Conformance to Settings Policy	13
1.6 Data Structures	13
1.6.1 Units of measurement	15
1.6.2 Counting in JDF	15
Chapter 2 Overview	17
2.1 Introduction	17
2.2 System Components	17
2.2.1 Job Components	17
2.2.2 Workflow Component Roles	18
2.2.3 System Interaction	19
2.3 JDF Workflow	20
2.3.1 Job Structure	21
2.4 Hierarchical Tree Structure and Networks in JDF	22
2.5 Role of Messaging in JDF	24
2.6 Coordinate Systems in JDF	24
2.6.1 Introduction	24
2.6.2 Coordinates and Transformations	26
2.6.3 Coordinate Systems of Resources and Processes	26
2.6.4 Coordinate System Transformations	27
2.6.5 Product Example: Simple Brochure	28
2.6.6 General Rules	32
2.6.7 Homogeneous Coordinates	33
Chapter 3 Structure	35
3.1 Generic Contents of All Elements	35
3.1.1 Structure Diagram	36

3.2 JDF	37
3.2.1 ICS Versions Value	41
3.2.2 Structure Diagram of JDF Node	42
3.3 Common Node Types	42
3.3.1 Product Intent Nodes	43
3.3.2 Process Group Nodes	43
3.3.3 Combined Process Nodes	46
3.3.4 Process Nodes	49
3.4 AncestorPool	49
3.4.1 Ancestor	49
3.5 CustomerInfo	51
3.6 NodeInfo	51
3.7 StatusPool	51
3.8 ResourcePool and its Resource Children	51
3.8.1 ResourcePool	51
3.8.2 Resource	51
3.8.3 Abstract Resource	51
3.8.4 Structure Diagram	54
3.8.5 Resource Classes	55
3.8.6 Position of Resources within JDF Nodes	58
3.8.7 Pipe Resources	58
3.8.8 ResourceUpdate	58
3.9 ResourceLinkPool and ResourceLink	58
3.9.1 ResourceLinkPool	58
3.9.2 ResourceLink	59
3.9.3 Structure Diagram	61
3.9.4 Identification of Physical Resources	68
3.10 ResourcePool and ResourceLinkPool – Deep Structure	68
3.10.1 ResourceElement – Subelement of a Resource	69
3.10.2 ResourceRef – Element for Inter-Resource Linking and refelement	69
3.10.3 Set of Resources and Partitioned Subsets Thereof	71
3.10.4 Resource Amount	72
3.10.5 Description of Partitioned Resources	74
3.10.6 PartIDKeys Attribute and Partition Keys	81
3.10.7 Linking to Resources	90
3.10.8 Splitting and Combining Resources	94
3.11 AuditPool and Audit	96
3.11.1 AuditPool	96
3.11.2 Structure Diagram	97
3.11.3 Abstract Audit	97
3.11.4 Audit	98
3.12 JDF Extensibility	109
3.12.1 Namespaces in XML	109
3.12.2 Creating Extension Intent Elements	110
3.12.3 Extending Process Types	110

3.12.4 Extending the NodeInfo and CustomerInfo Nodes	110
3.12.5 Extending Existing Resources	110
3.12.6 Extending NMTOKEN Lists	111
3.12.7 Creating New Resources	111
3.12.8 Future JDF Extensions	111
3.12.9 Maintaining Extensions	111
3.12.10 Processing Unknown Extensions	112
3.12.11 Derivation of Types in XML Schema	112
3.13 JDF Versioning	112
3.13.1 JDF Versioning Requirements	112
3.13.2 JDF Version Definition	112
3.13.3 JDF Version Policies	112
Chapter 4 Life Cycle	115
4.1 Creation and Modification	115
4.1.1 Product Intent Constructs	115
4.1.2 Specification of Delivery of End Products	116
4.1.3 Specification of process Specifics for product intent nodes	116
4.2 Process Routing	117
4.2.1 Determining Executable nodes	117
4.2.2 Distributing processing to Work Centers or devices	118
4.2.3 Device / Controller Selection	119
4.3 Execution Model	119
4.3.1 Serial processing	119
4.3.2 Partial processing of nodes with Partitioned resources	120
4.3.3 Overlapping processing Using Pipes	122
4.3.4 Parallel processing	126
4.3.5 Iterative processing	127
4.3.6 Approval, Quality Control and Verification	127
4.4 Spawning and Merging	128
4.4.1 Standard Spawning and Merging	129
4.4.2 Spawning and Merging with resource Copying	129
4.4.3 Parallel Spawning and Merging of Partitioned resources	130
4.4.4 Simultaneous Spawning and Merging of Multiple nodes	131
4.5 Node and Resource IDs	131
4.6 Error Handling	131
4.6.1 Classification of Notifications	132
4.6.2 Event Description	132
4.6.3 Error Logging in the JDF File	132
4.6.4 Error Handling via Messaging (JMF)	132
4.7 Test Running	132
4.7.1 Resource Status During a Test Run	132
Chapter 5 Messaging	133
5.1 JMF	133

5.1.1 Message	134
5.1.2 Structure Diagram	136
5.2 JMF Message Families	137
5.2.1 Query	137
5.2.2 Command	138
5.2.3 Signal	139
5.2.4 Response	141
5.2.5 Acknowledge	142
5.2.6 Registration	144
5.3 JMF Handshaking	144
5.3.1 Single Query/Command Response Communication	144
5.3.2 Signal and Acknowledge Handshaking	144
5.3.3 Reliable Signaling	144
5.3.4 Persistent Channels	145
5.3.5 Subscription	146
5.3.6 Scope of Subscriptions	147
5.3.7 Deleting Persistent Channels	147
5.4 JMF Messaging Levels	147
5.5 Error and Event Messages	148
5.6 Message Template	148
5.6.1 Object Type Column	149
5.7 List of All JMF Messages	149
5.8 Messages for Events and Capabilities	151
5.9 Messages to Query/Command a Job, Device or Controller	152
5.10 Messages for Pipe Control	153
5.10.1 Common PipeControl Element	153
5.11 Queue Support	154
5.11.1 Queue Entry ID Generation	154
5.12 Messages for Queue Entry Handling	154
5.13 Messages for Global Handling of Queues	157
5.13.1 QueueEntryStatus	159
5.14 Elements for Queues	159
5.14.1 Queue	159
5.14.2 QueueEntry	160
5.14.3 QueueEntryDef	161
5.14.4 QueueFilter	161
5.15 Gang Jobs	163
5.16 Extending Messages	164
5.16.1 IfraTrack Support	164
5.17 AbortQueueEntry	165
5.17.1 AbortQueueEntryParams	166
5.18 CloseQueue	166
5.19 Events	166
5.20 FlushQueue	166

5.20.1 FlushQueue Command	166
5.20.2 FlushQueue Query	167
5.21 FlushResources	168
5.21.1 FlushResources Command	168
5.21.2 FlushResources Query	168
5.22 ForceGang	169
5.22.1	169
5.22.2 GangCmdFilter	169
5.23 GangStatus	169
5.23.1 GangQuFilter	170
5.23.2 GangInfo	170
5.24 HoldQueue	170
5.25 HoldQueueEntry	170
5.25.1 HoldQueueEntryParams	171
5.26 KnownControllers	171
5.27 KnownDevices	171
5.27.1 DeviceFilter	172
5.27.2 DeviceList	172
5.28 KnownJDFServices	172
5.29 KnownMessages	173
5.29.1 KnownMsgQuParams	173
5.29.2 MessageService	173
5.30 KnownSubscriptions	175
5.30.1 SubscriptionFilter	175
5.31 ModifyNode	176
5.31.1 ModifyNode Command	176
5.31.2 ModifyNode Signal	176
5.32 NewJDF	177
5.32.1 NewJDF Query	177
5.32.2 NewJDF Command	178
5.33 NodeInfo	179
5.34 Notification	179
5.34.1 NotificationFilter	179
5.35 Occupation	180
5.36 OpenQueue	180
5.37 PipeClose	181
5.38 PipePause	181
5.39 PipePull	181
5.40 PipePush	182
5.41 QueueStatus	183
5.42 RemoveQueueEntry	183
5.42.1 RemoveQueueEntryParams	184
5.43 RepeatMessages	184
5.44 RequestForAuthentication	184

5.44.1 RequestForAuthentication Command	184
5.44.2 RequestForAuthentication Query	186
5.45 RequestQueueEntry	187
5.45.1 RequestQueueEntryParams	188
5.46 Resource	188
5.46.1 Resource Query	188
5.46.2 Resource Command	192
5.47 ResourcePull	198
5.47.1 ResourcePullParams	199
5.48 ResubmitQueueEntry	200
5.48.1 ResubmissionParams	200
5.49 ResumeQueue	200
5.50 ResumeQueueEntry	201
5.50.1 ResumeQueueEntryParams	201
5.51 ReturnQueueEntry	201
5.51.1 ReturnQueueEntryParams	202
5.52 SetQueueEntryPosition	202
5.52.1 QueueEntryPosParams	203
5.53 SetQueueEntryPriority	203
5.53.1 QueueEntryPriParams	203
5.54 ShutDown	203
5.54.1 ShutDownCmdParams	204
5.55 Status	204
5.55.1	204
5.55.2 StatusQuParams	205
5.55.3 DeviceInfo	206
5.55.4 JobPhase	207
5.55.5 ModuleStatus	209
5.56 StopPersistentChannel	210
5.56.1 StopPersChParams	211
5.57 SubmissionMethods	211
5.57.1 SubmissionMethods	211
5.58 SubmitQueueEntry	212
5.58.1 QueueSubmissionParams	213
5.59 SuspendQueueEntry	215
5.59.1 SuspendQueueEntryParams	215
5.60 Track	215
5.61 UpdateJDF	215
5.61.1 UpdateJDF Command	215
5.61.2 UpdateJDF Signal	216
5.62 WakeUp	218
5.62.1 WakeUpCmdParams	219
Chapter 6 Processes	221
6.1 Process Template	221

6.2 General Processes	222
6.2.1 Approval	222
6.2.2 Buffer	222
6.2.3 Combine	223
6.2.4 Delivery	223
6.2.5 ManualLabor	223
6.2.6 Ordering	224
6.2.7 Packing	224
6.2.8 QualityControl	224
6.2.9 ResourceDefinition	224
6.2.10 Split	225
6.2.11 Verification	225
6.3 Prepress Processes	226
6.3.1 AssetListCreation	226
6.3.2 Bending	226
6.3.3 ColorCorrection	227
6.3.4 ColorSpaceConversion	227
6.3.5 ContactCopying	228
6.3.6 ContoneCalibration	229
6.3.7 CylinderLayoutPreparation	229
6.3.8 DBDocTemplateLayout	229
6.3.9 DBTemplateMerging	229
6.3.10 DieDesign	229
6.3.11 DieLayoutProduction	230
6.3.12 DigitalDelivery	232
6.3.13 FilmToPlateCopying	233
6.3.14 FormatConversion	233
6.3.15 ImageEnhancement	233
6.3.16 ImageReplacement	233
6.3.17 ImageSetting	233
6.3.18 Imposition	234
6.3.19 InkZoneCalculation	244
6.3.20 Interpreting	244
6.3.21 LayoutElementProduction	245
6.3.22 LayoutPreparation	245
6.3.23 LayoutShifting	246
6.3.24 PageAssigning	246
6.3.25 PDFToPSConversion	246
6.3.26 PDLCreation	247
6.3.27 Preflight	247
6.3.28 PreviewGeneration	248
6.3.29 Proofing	250
6.3.30 PSToPDFConversion	250
6.3.31 RasterReading	250
6.3.32 Rendering	251

6.3.33 RIPing	252
6.3.34 Scanning	252
6.3.35 Screening	252
6.3.36 Separation	253
6.3.37 ShapeDefProduction	253
6.3.38 SheetOptimizing	254
6.3.39 SoftProofing	254
6.3.40 Stripping	254
6.3.41 Tiling	256
6.3.42 Trapping	257
6.4 Press Processes	257
6.4.1 ConventionalPrinting	257
6.4.2 DigitalPrinting	259
6.4.3 Varnishing	260
6.4.4 IDPrinting	261
6.5 Postpress Processes	261
6.5.1 AdhesiveBinding	261
6.5.2 BlockPreparation	261
6.5.3 BoxFolding	262
6.5.4 BoxPacking	262
6.5.5 Bundling	263
6.5.6 CaseMaking	263
6.5.7 CasingIn	264
6.5.8 ChannelBinding	264
6.5.9 CoilBinding	265
6.5.10 Collecting	265
6.5.11 CoverApplication	266
6.5.12 Creasing	266
6.5.13 Cutting	266
6.5.14 DieMaking	267
6.5.15 Dividing	267
6.5.16 Embossing	267
6.5.17 EndSheetGluing	268
6.5.18 Feeding	268
6.5.19 Folding	270
6.5.20 Gathering	270
6.5.21 Gluing	271
6.5.22 HeadBandApplication	271
6.5.23 HoleMaking	272
6.5.24 Inserting	272
6.5.25 Jacketing	273
6.5.26 Labeling	274
6.5.27 Laminating	274
6.5.28 LongitudinalRibbonOperations	274
6.5.29 Numbering	275

6.5.30 Palletizing	275
6.5.31 Perforating	275
6.5.32 PlasticCombBinding	275
6.5.33 PrintRolling	276
6.5.34 RingBinding	276
6.5.35 SaddleStitching	277
6.5.36 ShapeCutting	277
6.5.37 Shrinking	277
6.5.38 SideSewing	278
6.5.39 SpinePreparation	278
6.5.40 SpineTaping	278
6.5.41 Stacking	278
6.5.42 StaticBlocking	281
6.5.43 Stitching	281
6.5.44 Strapping	282
6.5.45 StripBinding	282
6.5.46 ThreadSealing	283
6.5.47 ThreadSewing	283
6.5.48 Trimming	283
6.5.49 WebInlineFinishing	284
6.5.50 Winding	285
6.5.51 WireCombBinding	285
6.5.52 Wrapping	286
6.6 Postpress Processes Structure	286
6.6.1 Block Production	286
6.6.2 HoleMaking	287
6.6.3 Laminating	287
6.6.4 Numbering	287
6.6.5 Packaging Processes	287
6.6.6 Processes in Hardcover Book Production	288
6.6.7 Sheet Processes	288
6.6.8 Tip-on/in	288
6.6.9 Trimming	288
6.6.10 Web Processes	288
Chapter 7 Product Intent	291
7.0.1 Product Intent Descriptions	291
7.1 Intent Properties Template	292
7.1.1 Abstract Span Element	293
7.1.2 Span Elements	293
7.2 ArtDeliveryIntent	298
7.2.1 ArtDelivery	299
7.3 BindingIntent	301
7.3.1 AdhesiveNote	303
7.3.2 BindList	303

7.3.3 BindItem	303
7.3.4 AdhesiveBinding	304
7.3.5 BookCase	304
7.3.6 ChannelBinding	305
7.3.7 CoilBinding	305
7.3.8 EdgeGluing	305
7.3.9 HardCoverBinding	305
7.3.10 PlasticCombBinding	307
7.3.11 RingBinding	308
7.3.12 SaddleStitching	309
7.3.13 SideSewing	309
7.3.14 SideStitching	309
7.3.15 SoftCoverBinding	309
7.3.16 StripBinding	310
7.3.17 Tabs	311
7.3.18 Tape	311
7.3.19 ThreadSealing	311
7.3.20 ThreadSewing	312
7.3.21 WireCombBinding	312
7.4 ColorIntent	312
7.4.1 ColorsUsed	314
7.5 DeliveryIntent	314
7.5.1 DropltemIntent	316
7.5.2 DropltemIntent	318
7.5.3 Pricing	318
7.5.4 Payment	318
7.5.5 CreditCard	318
7.6 EmbossingIntent	318
7.6.1 EmbossingItem	319
7.7 FoldingIntent	320
7.8 HoleMakingIntent	320
7.9 InsertingIntent	321
7.9.1 InsertList	321
7.9.2 Insert	322
7.10 LaminatingIntent	322
7.11 LayoutIntent	323
7.12 MediaIntent	325
7.13 NumberingIntent	329
7.14 PackingIntent	329
7.15 ProductionIntent	330
7.16 ProofingIntent	330
7.16.1 PreflightItem	331
7.16.2 ProofItem	331
7.17 PublishingIntent	332

7.18 ScreeningIntent	333
7.19 ShapeCuttingIntent	333
7.19.1 ShapeCut	334
7.20 SizeIntent	334
7.21 VariableIntent	334
Chapter 8 Resources	337
8.1 AdhesiveBindingParams	337
8.2 ApprovalParams	337
8.2.1 ApprovalPerson	337
8.3 ApprovalSuccess	338
8.3.1 ApprovalDetails	338
8.4 Assembly	338
8.4.1 AssemblySection	340
8.4.2 PageAssignedList	340
8.5 AssetListCreationParams	341
8.6 BendingParams	341
8.7 BinderySignature	342
8.7.1 On the use of Bleed	345
8.7.2 On the use of Trim	345
8.7.3 Web cell alignment	346
8.7.4 SignatureCell	348
8.8 BlockPreparationParams	350
8.9 BoxFoldingParams	351
8.9.1 BoxFoldingType attribute values	351
8.9.2 BoxApplication	354
8.9.3 BoxFoldAction	354
8.10 BoxPackingParams	355
8.11 BufferParams	357
8.12 Bundle	357
8.12.1 BundleItem	358
8.13 BundlingParams	360
8.14 ByteMap	361
8.14.1 Band	362
8.14.2 PixelColorant	363
8.15 CaseMakingParams	363
8.16 CasingInParams	364
8.17 ChannelBindingParams	365
8.18 CoilBindingParams	366
8.19 CollectingParams	366
8.20 Color	367
8.20.1 DeviceNColor	370
8.20.2 Diecutting Data (DDES3)	371
8.20.3 PrintConditionColor	371

8.21 ColorantControl	374
8.21.1 ColorantConvertProcess	377
8.21.2 ColorantOrder	377
8.21.3 ColorantParams	377
8.21.4 ColorSpaceSubstitute	378
8.21.5 DeviceColorantOrder	379
8.22 ColorCorrectionParams	379
8.23 ColorPool	380
8.24 ColorSpaceConversionParams	380
8.25 Component	381
8.26 Contact	387
8.26.1 Company	388
8.26.2 OrganizationalUnit	388
8.27 ContactCopyParams	388
8.28 ContentList	389
8.28.1 ContentData	389
8.28.2 ContentMetadata	390
8.29 ConventionalPrintingParams	392
8.30 CoverApplicationParams	394
8.30.1 Score	395
8.31 CreasingParams	396
8.32 CustomerInfo	396
8.32.1 CustomerMessage	397
8.33 CutBlock	397
8.34 CutMark	398
8.35 CuttingParams	399
8.36 CylinderLayout	400
8.36.1 CylinderPosition	400
8.37 CylinderLayoutPreparationParams	402
8.38 DBMergeParams	403
8.39 DBRules	403
8.40 DBSchema	403
8.41 DBSelection	403
8.42 DeliveryParams	403
8.42.1 Drop	404
8.42.2 Dropltem	405
8.43 DevelopingParams	406
8.44 Device	406
8.44.1 Icon	408
8.44.2 IconList	409
8.44.3 Module	409
8.45 DieLayout	410
8.45.1 RuleLength	411
8.45.2 Station	411

8.46 DieLayoutProductionParams	411
8.46.1 RepeatDesc	412
8.47 DigitalDeliveryParams	416
8.48 DigitalMedia	417
8.49 DigitalPrintingParams	417
8.49.1 Coordinate systems in DigitalPrinting	417
8.50 DividingParams	420
8.51 ElementColorParams	420
8.52 EmbossingParams	421
8.52.1 Emboss	422
8.53 Employee	422
8.54 EndSheetGluingParams	423
8.54.1 EndSheet	424
8.55 ExposedMedia	424
8.56 ExternalImpositionTemplate	425
8.57 FeedingParams	426
8.57.1 CollatingItem	426
8.57.2 Feeder	427
8.57.3 FeederQualityParams	428
8.58 FileSpec	428
8.58.1 Container	433
8.58.2 FileAlias	434
8.59 FoldingParams	434
8.60 FontParams	435
8.61 FontPolicy	436
8.62 FormatConversionParams	436
8.63 GatheringParams	437
8.64 GlueApplication	437
8.65 GluingParams	438
8.65.1 Glue	438
8.66 HeadBandApplicationParams	439
8.67 HoleList	439
8.68 HoleMakingParams	440
8.69 IdentificationField	441
8.69.1 BarcodeDetails	444
8.69.2 ExtraValues	445
8.69.3 Usage of barcode attributes	445
8.70 IDPrintingParams	447
8.71 ImageCompressionParams	447
8.71.1 ImageCompression	447
8.71.2 CCITTFaxParams	449
8.71.3 DCTParams	450
8.71.4 FlateParams	450
8.71.5 JBIG2Params	451

8.71.6 JPEG2000Params	451
8.71.7 LZWParams	452
8.72 ImageEnhancementParams	452
8.72.1 ImageEnhancementOp	452
8.73 ImageReplacementParams	453
8.73.1 SearchPath	454
8.74 ImageSetterParams	454
8.75 Ink	456
8.76 InkZoneCalculationParams	457
8.77 InkZoneProfile	457
8.78 InsertingParams	458
8.79 InterpretedPDLData	459
8.80 InterpretingParams	459
8.80.1 InterpretingDetails	461
8.80.2 PDFInterpretingParams	461
8.80.3 ReferenceXObjectParams	462
8.81 JacketingParams	462
8.82 LabelingParams	463
8.83 LaminatingParams	464
8.84 Layout	465
8.84.1 CIELABMeasuringField	468
8.84.2 ColorControlStrip	469
8.84.3 ContentObject	470
8.84.4 DensityMeasuringField	471
8.84.5 DynamicField	471
8.84.6 FillMark	472
8.84.7 LayerDetails	473
8.84.8 LayerList	473
8.84.9 LogicalStackParams	473
8.84.10 MarkActivation	474
8.84.11 MarkObject	475
8.84.12 PageCondition	476
8.84.13 PlacedObject	477
8.84.14 SheetCondition	480
8.84.15 Signature	480
8.84.16 Stack	480
8.84.17 More about Layout	481
8.85 LayoutElement	485
8.85.1 Dependencies	487
8.86 LayoutElementProductionParams	487
8.86.1 LayoutElementPart	489
8.86.2 BarcodeProductionParams	490
8.86.3 PositionObj	490
8.87 LayoutPreparationParams	493

8.87.1 PageCell	500
8.87.2 ImageShift	501
8.88 LayoutShift	504
8.88.1 ShiftPoint	504
8.89 LongitudinalRibbonOperationParams	505
8.90 ManualLaborParams	505
8.91 Media	506
8.91.1 TabDimensions	512
8.91.2 More about Media	514
8.92 MediaSource	516
8.93 MiscConsumable	516
8.94 NodeInfo	517
8.95 NumberingParams	520
8.96 OrderingParams	520
8.97 PackingParams	520
8.98 PageAssignParams	520
8.99 PageList	520
8.99.1 PageData	521
8.99.2 PageElement	523
8.100 Pallet	524
8.101 PalletizingParams	524
8.102 PDFToPSConversionParams	525
8.103 PDLCreationParams	527
8.104 PDLResourceAlias	528
8.105 PerforatingParams	528
8.106 PlaceholderResource	528
8.107 PlasticCombBindingParams	528
8.108 PlateCopyParams	529
8.109 PreflightAnalysis	529
8.110 PreflightInventory	529
8.111 PreflightParams	529
8.111.1 PreflightAction	530
8.111.2 BasicPreflightTest	530
8.111.3 PreflightArgument	531
8.111.4 BoxArgument	531
8.111.5 BoxToBoxDifference	532
8.112 PreflightProfile	532
8.113 PreflightReport	532
8.113.1 PRItem	533
8.113.2 PRError	533
8.113.3 PRGroup	534
8.113.4 Abstract PRGroupOccurrenceBase	536
8.113.5 PRGroupOccurrenceBase	537
8.113.6 ArgumentValue	537

8.113.7 PRGroupOccurrence	537
8.113.8 StringListValue	537
8.113.9 PROccurrence	537
8.114 PreflightReportRulePool	538
8.114.1 PRRule	538
8.114.2 PRRuleAttr	538
8.115 Preview	540
8.116 PreviewGenerationParams	541
8.117 PrintCondition	543
8.118 PrintRollingParams	544
8.119 ProductionPath	544
8.119.1 FolderSuperstructureWebPath	545
8.119.2 PostPressComponentPath	545
8.119.3 PrintingUnitWebPath	545
8.120 ProofingParams	546
8.121 PSToPDFConversionParams	546
8.121.1 AdvancedParams	548
8.121.2 PDFXParams	549
8.121.3 ThinPDFParams	550
8.122 QualityControlParams	551
8.122.1 BindingQualityParams	551
8.123 QualityControlResult	552
8.123.1 QualityMeasurement	552
8.123.2 BindingQualityMeasurement	553
8.124 RasterReadingParams	553
8.125 RegisterMark	554
8.126 RenderingParams	555
8.126.1 TIFFEmbeddedFile	556
8.126.2 TIFFFormatParams	556
8.126.3 TIFFtag	557
8.127 ResourceDefinitionParams	557
8.127.1 ResourceParam	558
8.128 RingBindingParams	558
8.129 RollStand	559
8.130 RunList	560
8.130.1 Pages, Documents and Sets for common PDL types	564
8.130.2 DynamicInput	565
8.131 SaddleStitchingParams	567
8.132 ScanParams	567
8.133 ScavengerArea	568
8.134 ScreeningParams	569
8.135 SeparationControlParams	569
8.136 Shape	569
8.137 ShapeCuttingParams	570

8.138 ShapeDef	571
8.139 ShapeDefProductionParams	572
8.139.1 ObjectModel	572
8.139.2 ShapeTemplate	573
8.140 Sheet	574
8.141 SheetOptimizingParams	574
8.141.1 GangElement	575
8.141.2 SeparationListBack	577
8.141.3 SeparationListFront	577
8.142 ShrinkingParams	577
8.143 SideSewingParams	577
8.144 SpinePreparationParams	577
8.145 SpineTapingParams	578
8.146 StackingParams	579
8.147 StaticBlockingParams	581
8.148 StitchingParams	581
8.149 Strap	583
8.150 StrappingParams	584
8.151 StripBindingParams	585
8.152 StrippingParams	586
8.152.1 Position	588
8.152.2 StripCellParams	590
8.152.3 StripMark	592
8.153 Surface	596
8.154 ThreadSealingParams	596
8.155 ThreadSewingParams	596
8.156 Tile	598
8.157 Tool	598
8.158 TransferCurve	599
8.159 TransferCurvePool	600
8.159.1 TransferCurveSet	600
8.160 TransferFunctionControl	601
8.161 TrappingDetails	601
8.161.1 TrappingOrder	602
8.162 TrappingParams	602
8.162.1 ColorantZoneDetails	604
8.163 TrapRegion	605
8.164 TrimmingParams	605
8.165 UsageCounter	606
8.166 VarnishingParams	606
8.167 VerificationParams	607
8.168 WebInlineFinishingParams	608
8.168.1 FolderProduction	608
8.169 WindingParams	608

8.170 WireCombBindingParams	609
8.171 WrappingParams	609
Chapter 9 Subelements	611
9.1 Address	611
9.1.1 AddressLine	611
9.1.2 ExtendedAddress	612
9.2 AutomatedOverPrintParams	612
9.3 BarcodeCompParams	612
9.4 BarcodeReproParams	613
9.5 Certification	613
9.6 ColorantAlias	614
9.7 ColorCorrectionOp	615
9.8 ColorMeasurementConditions	615
9.9 ColorSpaceConversionOp	616
9.10 ComChannel	619
9.10.1 ChannelTypeDetails Attribute	620
9.11 Comment	620
9.12 ConvertingConfig	622
9.13 CostCenter	622
9.14 Crease	622
9.15 Cut	623
9.16 CutLines	624
9.17 DeviceMark	624
9.18 DeviceNSpace	626
9.19 Disjointing	626
9.20 Disposition	627
9.21 FitPolicy	628
9.22 Fold	629
9.23 GangSource	630
9.24 GeneralID	630
9.25 GlueLine	631
9.26 Hole	632
9.27 HoleLine	632
9.28 InsertSheet	633
9.29 JobField	636
9.30 MarkColor	636
9.31 MediaLayers	636
9.32 MetadataMap	637
9.32.1 Expr	638
9.33 MISDetails	641
9.34 ObjectResolution	642
9.35 OCGControl	643

9.36 Perforate	644
9.37 Person	645
9.38 RefAnchor	645
9.39 RegisterRibbon	646
9.40 ScreenSelector	646
9.41 SeparationSpec	648
9.42 SubscriptionInfo	648
Chapter 10 Device Capabilities	651
10.1 Capability and Constraint Definitions	651
10.2 Device Capability Definitions	652
10.2.1 DeviceCap	652
10.2.2 ActionPool	655
10.2.3 DevCapPool	656
10.2.4 ModulePool	656
10.2.5 DevCaps	657
10.2.6 DevCap	659
10.2.7 State	661
10.2.8 DisplayGroupPool	673
10.2.9 FeaturePool	674
10.2.10 MacroPool	675
10.2.11 Performance	677
10.2.12 TestPool	678
10.2.13 Term	678
10.2.14 Examples of Device Capabilities	689
10.3 Concept of the Preflight Process	694
10.3.1 Object Classes	695
10.3.2 Properties	698
Chapter 11 Building a System	715
11.1 Implementation Considerations and Guidelines	715
11.2 JDF and JMF Interchange Protocol	715
11.2.1 File-Based Protocol (JDF)	715
11.2.2 HTTP-Based Protocol (JDF + JMF)	715
11.2.3 HTTPS-Based Protocol – SSL with two-way authentication	715
11.2.4 Managing Persistent Channels	718
11.2.5 Deleting Persistent Channels	718
11.3 JDF Packaging	718
11.3.1 MIME Basics	719
11.3.2 MIME Types and File Extensions	719
11.4 MIS Requirements	722
11.5 Interoperability Conformance Specifications	722
Appendix A Data Types and Values	725
A.1 Notes About Encoding	725

A.1.1 List, Range and Range List Data Types	725
A.1.2 Whitespace	725
A.1.3 Infinity Limits	725
A.2 Simple Types — Attribute Values	725
A.2.1 boolean	725
A.2.2 CMYKColor	725
A.2.3 date	726
A.2.4 dateTime	726
A.2.5 DateTimeRange	726
A.2.6 DateTimeRangeList	726
A.2.7 double	726
A.2.8 DoubleList	727
A.2.9 DoubleRange	727
A.2.10 DoubleRangeList	727
A.2.11 duration	727
A.2.12 DurationRange	727
A.2.13 DurationRangeList	728
A.2.14 gYearMonth	728
A.2.15 hexBinary	728
A.2.16 ID	728
A.2.17 IDREF	728
A.2.18 IDREFS	729
A.2.19 integer	729
A.2.20 IntegerList	729
A.2.21 IntegerRange	729
A.2.22 IntegerRangeList	729
A.2.23 LabColor	730
A.2.24 language	730
A.2.25 languages	730
A.2.26 matrix	730
A.2.27 NameRange	731
A.2.28 NameRangeList	731
A.2.29 NMTOKEN	731
A.2.30 NMTOKENS	731
A.2.31 PDFPath	731
A.2.32 rectangle	732
A.2.33 RectangleRange	732
A.2.34 RectangleRangeList	732
A.2.35 regExp	732
A.2.36 shape	733
A.2.37 ShapeRange	733
A.2.38 ShapeRangeList	733
A.2.39 sRGBColor	733
A.2.40 string	733
A.2.41 TimeRange	734

A.2.42 TransferFunction	734
A.2.43 URI	734
A.2.44 URL	734
A.2.45 XPath	735
A.2.46 XYPair	735
A.2.47 XYPairRange	735
A.2.48 XYPairRangeList	736
A.3 Enumerations	736
A.3.1 Action	736
A.3.2 Activation	736
A.3.3 Anchor	737
A.3.4 ArtHandling	738
A.3.5 ArtTransfer	738
A.3.6 Automation	738
A.3.7 Axis	739
A.3.8 BinderMaterial	739
A.3.9 BindingType	739
A.3.10 BoxType	740
A.3.11 BundleType	741
A.3.12 ChannelMode	741
A.3.13 Coating	741
A.3.14 Compensation	742
A.3.15 DataType	742
A.3.16 DefaultPriority	743
A.3.17 DeliveryCharge	743
A.3.18 Drying	743
A.3.19 Edge	743
A.3.20 ElementType	743
A.3.21 EmbossDirection	744
A.3.22 EmbossLevel	744
A.3.23 EmbossType	745
A.3.24 FeedQuality	745
A.3.25 FitPolicy	745
A.3.26 GangPolicy	746
A.3.27 Glue	746
A.3.28 IncludeResources	746
A.3.29 ISOPaperSubstrate	746
A.3.30 JDFJMFVersion	747
A.3.31 ListType	747
A.3.32 MappingSelection	747
A.3.33 MediaDirection	748
A.3.34 MediaType	748
A.3.35 NamedColor	749
A.3.36 Opacity	749
A.3.37 Orientation	750

A.3.38 Polarity	750
A.3.39 PositionPolicy	750
A.3.40 PreflightStatus	750
A.3.41 PreviewUsage	751
A.3.42 QueueEntryStatus	751
A.3.43 RenderingIntent	752
A.3.44 ResourceClass	752
A.3.45 ResourceStatus	752
A.3.46 ResourceUsage	753
A.3.47 Scope	753
A.3.48 Severity	753
A.3.49 SheetLay	754
A.3.50 Side	754
A.3.51 Sides	754
A.3.52 SourceColorSpace	754
A.3.53 SourceObjects	757
A.3.54 StapleShape	758
A.3.55 Status	758
A.3.56 StripMaterial	759
A.3.57 SurplusHandling	759
A.3.58 TightBacking	759
A.3.59 Usage	760
A.3.60 WorkingDirection	760
A.3.61 WorkStyle	760
A.3.62 XYRelation	761
A.4 Preferred String and NMTOKEN Values	762
A.4.1 Comb and Coil Shapes	762
A.4.2 Contact Types	762
A.4.3 Content Types	763
A.4.4 Delivery Methods	763
A.4.5 Device Classes	764
A.4.6 Flute Types	766
A.4.7 Fold Catalog	766
A.4.8 Ink and Varnish Coatings	769
A.4.9 Input Tray and Output Bin Names	770
A.4.10 MediaType Details	772
A.4.11 Milestones	773
A.4.12 Module Types	775
A.4.13 Node Categories	779
A.4.14 Notification Details	779
A.4.15 Pallet Types	782
A.4.16 Printing Technologies	782
A.4.17 PrintStandard Characterization Data Sets	783
A.4.18 Process Usage	783
A.4.19 Product Types	784

A.4.20 Service Levels	786
A.4.21 Spine Operations	786
A.4.22 Status Details	787
A.4.23 Texture	791
A.4.24 Units	791
A.5 JDF File Formats	792
A.5.1 PNG Image Format	792
Appendix B Schema	793
B.1 Using xsi:type	793
B.1.1 Using xsi:type with JDF Nodes	793
B.1.2 Using xsi:type with JMF Messages	794
Appendix C Return Values	795
Appendix D Color Adjustment	799
D.1 Adjustment Using Direct Attributes	799
D.2 Adjustment using ICC Profile Attributes	800
D.3 Adjustment using an ICC Abstract Profile Attribute	800
D.4 Adjustment using an ICC DeviceLink Profile Attribute	800
Appendix E Media Weight	801
E.1 North American Media Weight	801
E.2 Japanese Media Weight	802
E.3 Paper Grade	803
Appendix F Media Size	805
F.1 Architectural Paper Sizes	805
F.2 Business Card Sizes	805
F.3 International A Paper Sizes	805
F.4 International B Paper Sizes	806
F.5 International C Envelope Sizes	807
F.6 RA and SRA Paper Sizes	807
F.7 US ANSI Paper Sizes	807
F.8 US Paper Sizes	808
Appendix G MimeTypes	809
Appendix H String Generation	815
Appendix I Pagination Catalog	819
I.1 How to interpret the diagrams	819
I.1.1 Legend	819
I.1.2 Meaning of a Pagination Scheme	819
I.1.3 Settings that Modify the Pagination Schemes	820
I.1.4 Using the Settings to Find the Needed Scheme Transformation	820
I.1.5 Examples of applying BindingOrientation	822
I.2 Pagination Diagrams	825

Appendix J Resolving Directory URL References	839
J.1 Semantics of the RunList/@Directory attribute	839
Appendix K Hole Pattern Catalog	841
K.1 Naming Scheme	841
K.2 Ring Binding - Two Hole	842
K.3 Ring Binding - Three Hole	842
K.4 Ring Binding - Four Hole	843
K.5 RingBinding - Five Hole	844
K.6 Ring Binding - Six Hole	844
K.7 Ring Binding - Seven Hole	845
K.8 Ring Binding - Eleven Hole	846
K.9 Plastic Comb Binding	846
K.10 Wire Comb Binding	847
K.11 Coil and Spiral Binding	847
K.12 Special Binding	848
Appendix L FileSpec Use Cases	849
L.1 Examples of Attribute Values of FileSpec	849
L.2 Corresponding XML examples	850
L.3 Additional examples showing Partitioning of FileSpec	852
L.4 Example of an Intent Job Ticket with a doubly nested ZIP packaging file	857
L.5 AppOS and OSVersion Attributes	858
Appendix M References	859
Appendix N Release Notes	871



Preface

This specification is immense ... there is little doubt about that ... but it is also a keystone standard for the future of graphic communications. The members of CIP4 believe that users and developers alike need to have a clear understanding of what the objectives of the Job Definition Format (**JDF**) are as well as an understanding of its value and purpose. To that end we thought you would find a “non-standard” preface and user overview helpful.

Before we get into the overview, we remind you that **JDF** is a living specification. We would value your comments and input. There are several ways to contact the International Cooperation for the Integration of Processes in Prepress, Press and Postpress (CIP4) and to receive ongoing information about CIP4 activities. To get a list of contacts, join the **JDF** developers form, or sign up for Email updates, visit the contact page at <http://www.cip4.org/>. (Of course, we'd love to have you as a CIP4 member too! Be sure to review the membership page when you visit the CIP4 Website.)

You will also find callouts throughout this document that are identified by three different icons. These callouts, provided for your convenience, are not normative parts of the standard (i.e., they're not technically a part of the *standard*). They provide references to external sources, executive summaries of complex technical concepts, and some thoughts or strategies to consider as you formulate your **JDF** implementation plan. Look for these callout icons:

Table Preface 1: Callout Icon Usage

ICON	CALLOUT TYPE
	External references to online resources, related standards, tutorials and helpful information.
	Executive-style summaries of technical concepts in easy-to-understand language.
	Thoughts to ponder and strategy ideas for formulating JDF implementation programs.

Value. This revision of **JDF** is significant because it builds upon the fifth version of **JDF** (v.1.4) to deliver a fully functional and mature standard. As such, this revision includes elements from which executives, shop managers and technicians will all benefit equally, though in different ways. In the next few years it is our belief that this specification will positively effect everyone involved in the creation and production of printing; regardless of form (offset, digital, flexographic and so on) or function (direct mail, periodical publication, packaging and so on). Furthermore, **JDF** will be of value to companies both large and small. Some of the benefits that **JDF** provides include:

- A common language for describing a print job across enterprises, departments and software and systems;
- A tool for verifying the accuracy and completeness of job tools;
- A systems interface language that can be used to benchmark the performance of new equipment (hardware and software) and that can reduce the cost of expensive custom integration for printers, prepress services and others;
- A basis for total workflow automation that incorporates all aspects of production: human, machine and computer;
- A standard that can be applied to eliminate wasteful re-keying and redundancy of information; and
- A common computer language for printing and related industries as well as a platform for more effective communication.



Implementation Strategy

As you read this standard, consider how to make JDF a part of your equipment evaluation and purchasing procedures. Do you add JDF enabled systems slowly with equipment replacement and upgrades, or aggressively as part of a plant re-engineering process? What's your desired competitive position?

Most importantly, **JDF** provides an opportunity for users of graphic arts equipment to get a better return on their technology investment and an opportunity to create a print production and distribution workflow that is more competitive with broadcast media in terms of time-to-market.

XML and Schema: Why? The Extensible Markup Language (XML) is the standard language that is employed by **JDF** is also constructed to the World Wide Web Consortium's (W3C) recommendation for the construction of schema. Why is this important and, in layman's terms, what does it do for you?

First of all, it is helpful to understand how MIS professionals around the world use XML today. Although there are some systems that manage and process XML directly, it is primarily used as an exchange language or “middleware” element to create the “glue” that ties integrated systems together.

For instance, complex systems such as enterprise resource planning (ERP), data warehousing or E-commerce systems often tap into numerous legacy databases and application environments. A manager might wish to have a “view” of corporate information that is actually an aggregate of information that might come from various sources such as billing and invoicing, sales management, inventory and other systems. Rather than merge these systems into a single, monstrous and centralized system, an operator queries the legacy systems and the results are wrapped in XML. This allows programmers to deal with one exchange language or data format instead of a multitude of proprietary data formats.

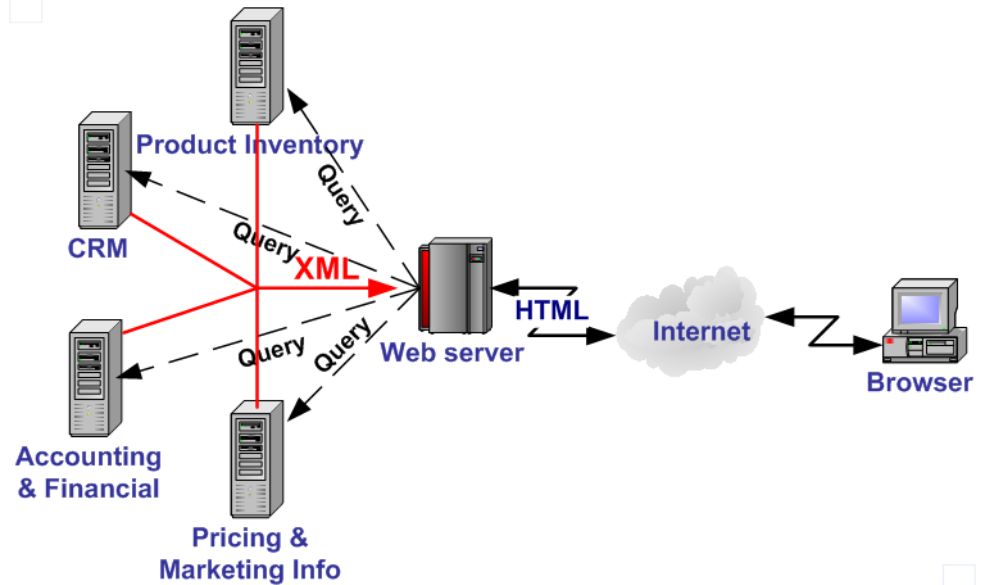

XML is not a *functional* computer language like JAVA, C++ or FORTRAN—it is incapable of manipulating data in anyway; rather, it is a *descriptive* computer language that can be used to describe your information including its structure, inter-relationships, and to some extent, its intended usage. For this reason, modern program languages such as JAVA provide intrinsic support for XML processing. Most modern database applications also provide methods for receiving and delivering XML.

Early XML, based solely upon the XML 1.0 specification, had a few limitations that prevented it from being used widely as a transactional data format *across* enterprises, as opposed to *within* enterprises (where it found its niche as described above). For example, there is probably a database behind each of your major systems and applications. If your database has reserved a fixed space a data particular field and a supplier provides a transaction with a data element larger than that field, you have a problem. The data limitations of XML 1.0 cannot effectively deal with this. The XML Schema specification solved this problem and others.



XML Schema

To learn more about XML Schema, including tools, usage, tutorials and other resources see ▶ [\[XMLSchema Status\]](#).

The Plusses of Parsing. Schemas also provide one other feature that is perhaps the greatest benefit. Tagged documents or transactions (called “instances” in XML parlance) are *parsible*. Schemas, such as **JDF**, establish rules for structuring your information. A parser is a software application that reads those rules, checks documents and transactions, and then validates that they conform to the rules as established in your schema ... sort of like preflighting but for XML instances rather than your layout pages.

Parsers can play many roles. Like preflighting software, parsers can be run as stand-alone applications, but they can also be found embedded into other applications. Some of the roles parsers can play in your **JDF** enabled workflow include:



Free Parsers

The JDF schema was validated with the Xerces parser. This parser, as well as other XML tools, is available for free from The Apache Software Foundation. See ▶ [\[Apache Foundation\]](#).

- 1 Acceptance checking of client job tickets;
- 2 Validation of **JDF** prior to or following transformation of data into and out of databases;
- 3 Ensuring that source job information is collected as a document is created (embedded in document layout software);
- 4 Determining if equipment reads and writes Job Messaging Format (**JMF**) commands, a subset of **JDF**, as part of equipment benchmarking and testing software;
- 5 Controlling the movement of workflow information and controls within workflow software from process to process and as a specific **JDF** job ticket requires;
- 6 Working as a middleware component to communicate between **JDF** enabled software and systems and your legacy Management Information System (MIS) and corporate applications environments.

It is worth mentioning that parsing can be time consuming and computer intensive. But parsers don’t have to be the gatekeepers everywhere in a **JDF** enabled workflow. Equipment that is **JDF** enabled and part of a company’s internal production operations need not parse every communication. It can be limited to equipment evaluation and problem solving

applications. The role of **JDF** parser-enabled software in a printing plant that uses tightly coupled **JDF** enabled print production equipment might look like this:

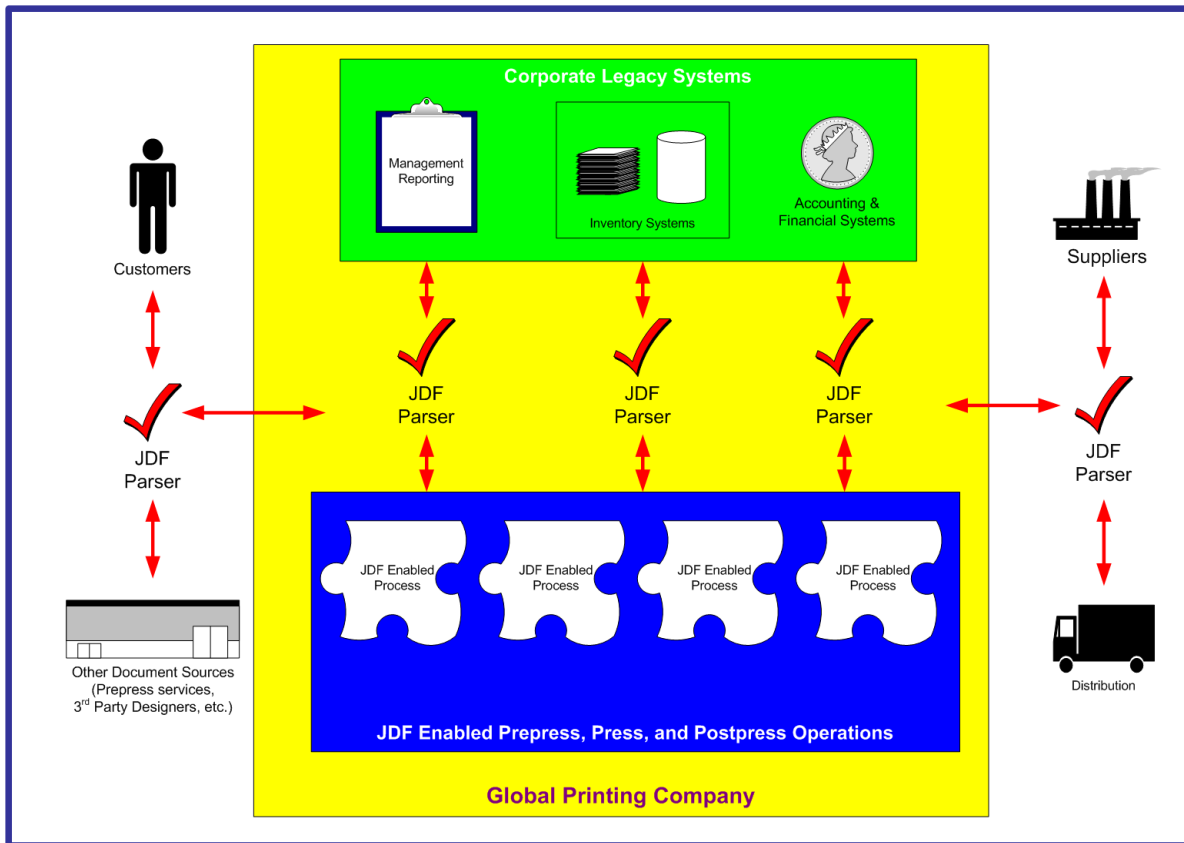

The JDF Concept. The **JDF** specification is quite complex and detailed—something best left to programmers and XML experts. But the concepts behind **JDF** are quite simple and straightforward. It provides an explanation of each of the components of **JDF**, its meaning and intended usage. You will want to use the components of **JDF** that fit best with your workflow and the needs of your customers. To start, a basic understanding of the concepts behind **JDF** is in order. There are four primary components that comprise the **JDF** environment:

- 1 JDF itself,
- 2 The Job Messaging Format (JMF)
- 3 JDF Capabilities and
- 4 ICS Documents

JDF is an exchange format for instructions and job parameters. You can use PDF or its standard variant (PDF/X), to relay content data files from one platform to another. You can do the same with **JDF** to relay job parameters and instructions. **JDF** can be used to describe a printing job logically, as you would in exchanging a job description with a client within an estimate. It can also be used to describe a job in terms of individual production processes and the materials or other process inputs needed to complete a job.

There is no such thing as a standard print workflow. In fact, printing is the ultimate form of *flexible manufacturing*. This makes process automation quite a challenge for our industry. What you'll find in this standard are XML element definitions that describe all the production processes and material types you're likely to encounter, regardless of your workflow. These are the building blocks that you can use to emulate your workflow with **JDF**. Every process in the print production workflow requires input *resources* starting with the client's files or artwork and ending with the final bound, packaged and labeled print product. For example, before you can print, you need paper, ink and plates, and before you can send a document to a bindery line, you need printed and cut signatures.

Process *nodes* and *resources* are the basic elements within **JDF**. They can be strung together to meet the requirements of each job. The output of one process becomes the input of the following process, and a process doesn't begin until its input resources are available:



Example:

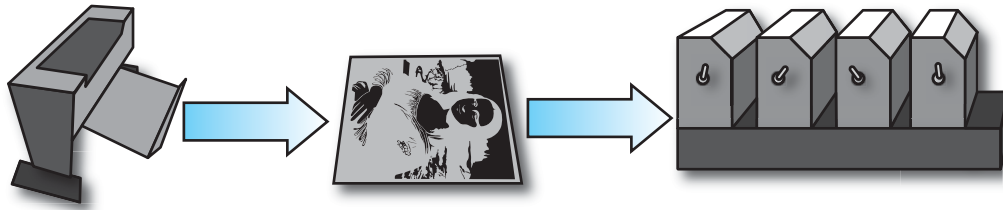

This specification provides details on how to use these building blocks to describe concurrent processes, spawned processes, dynamic processes and so on. To realize the capabilities of **JDF**, there are two other things you will need: a way of controlling the flow of process and a way of communicating commands to equipment on the shop floor. **JMF** is a subset of **JDF** that handles communication with equipment on the shop floor. This might include major equipment, such as platesetters or subsystems, such as in-line color measurement devices. **JMF** can be used to establish a queue, discover the capabilities of a **JDF** enabled device, determine the status of a device (e.g., “RIPing,” “Idle” and so on).

Although, theoretically, you can string together equipment that supports **JMF** directly to one another, in almost all cases you will want your production equipment to communicate with your MIS or Production Control system. This way it is the MIS system that controls the scheduling, execution and control of work in progress. The role of the MIS system is described within this standard, but it isn't highly defined. In fact, the **JDF** standard does not dictate how a **JDF** system is to be built. Many printers, prepress services and other graphic arts shops will already have MIS systems in place. **JDF** enabled workflow and MIS systems, custom-tailored to print production requirements, will soon be available on the market. However, many printers already have MIS and workflow systems that have been customized or developed for their own environments. In most cases these legacy systems can be modified to work with the new **JDF** workflows and **JDF** enabled equipment.



JMF

The Job Messaging Format (JMF) functions as a standard interface between your equipment and your information systems or other equipment already on the shop floor. By buying only equipment that supports JMF you will reduce the cost and complexity of integrating new equipment into your production operations, and you will improve the flexibility and adaptability of your shop.

Changes to JDF 1.6

JDF 1.6 is designed as the backwards compatible sibling of **XJDF** 2.0. It contains only incremental updates to **JDF** 1.5

ICS Documents and Certification

The concept of Interoperability Conformance Specification of “ICS” documents is introduced. No single device (i.e., printer, press, imagesetter, etc.) is likely to implement all that the **JDF** specification provides for. For instance, if you are in the digital printing business, you might not care to process data used for case binding. A RIP is not a requirement for facilitating **JDF** preflighting. A Stitcher probably doesn't need to handle image rendering data.

To specify exactly what individual classes of devices need to do with **JDF** CIP4 members are developing ICS document that will provide the minimum expectations for individual classes of devices. ICS documents will later be used as the basis for certification testing. Once the certification program begins, you will start seeing products that are marked as “JDF Certified” and this will be certification to identified levels of one or more specific ICS documents. An initial set of ICS documents is freely available to the public, and we expect that they will become part of your buying practices. ICS documents for additional classes of devices are currently under development.

1 Introduction

This document defines the technical specification for the Job Definition Format (**JDF**) and its counterpart, the Job Messaging Format (**JMF**).

We will describe the components of **JDF**, both internal and external, and explain how to integrate the format components to create a viable workflow. Ancillary aspects are also introduced, such as how to convert PJTF or PPF to **JDF**, and how **JDF** relates to IfraTrack. It is intended for use by programmers and systems integrators for operations addressed by the International Cooperation for Integration of Processes in Prepress, Press and Postpress (CIP4). In this first chapter, we present the concept of **JDF**, and its relationship to **JDF** and other industry standards and how to use this document and some basic document navigational aids.

1.1 Further Information

Additional information such as application notes and examples can be found on the CIP4 website at <http://www.cip4.org>.

1.2 Background on JDF

JDF is an extensible, XML-based format built upon the existing technologies of CIP3's Print Production Format ▶ [CIP3 - PPF] and Adobe's Portable Job Ticket Format ▶ [PJTF]. It provides three primary benefits to the printing industry:

- 1 The ability to unify the prepress, press and postpress aspects of any printing job, unlike any previous format;
- 2 The means to bridge the communication gap between production services and Management Information Systems (▶ MIS); and
- 3 The ability to carry out both of these functions no matter what system architecture is already in place and no matter what tools are being used to complete the job. In short, **JDF** is extremely versatile and comprehensive.

JDF is an interchange data format to be used by a system of administrative and implementation-oriented components, which together produce printed products. It provides the means to describe print jobs in terms of the products eventually to be created, as well as in terms of the processes needed to create those products. The format provides a mechanism to explicitly specify the controls needed by each process, which might be specific to the devices that will execute the processes.

JDF works in tandem with a counterpart format known as the Job Messaging Format or **JMF**. **JMF** provides the means for production components of a **JDF** workflow to communicate with system controllers and administrative components. It relays information about the progress of **JDF** jobs and gives ▶ MIS the active ability to query devices about the status of processes being executed or about to be executed. **JMF** will provide the complete job tracking functionality that is defined by IfraTrack messaging standard. Depending on the system architecture, **JMF** might also provide the means to control certain aspects of these processes directly.

JDF and **JMF** are maintained and developed by CIP4 (<http://www.cip4.org>). They were originally developed by four companies prominent in the graphic arts industry—Adobe, Agfa, Heidelberg and MAN Roland — with significant contribution from CIP3, the IfraTrack working group, Fraunhofer IGD and the PrintTalk consortium.

1.3 Conventions Used in This Specification

This section contains conventions and notations used within this document.

1.3.1 Document References

Throughout this specification, references to other documents are indicated by short symbolic names inside square brackets (e.g., ▶ [ICC.1]). ▶ Appendix M References lists all such references, with their full title, date, source and availability.

1.3.2 Text Styles

The following text styles are used to identify the components of a **JDF** job.

INTRODUCTION

- Elements and resources are written in *blue san serif bold italic*. Examples are **Comment**, **BundleItem** and **ResourceLink** elements, and **Ink**, **Layout** and **ExposedMedia** resources. This style is also used when referring to the XML **JDF** or **JMF** root elements.
- Attributes are written in *dark blue san serif italic*. Examples are **@Status**, **@ResourceID** and **@ID**.
- Process types are written in **purple san serif bold**. Examples are **ColorSpaceConversion** and **Rendering**.
- Enumerative and boolean values of attributes are written in **red san serif**. Examples are **"true"**, **"Waiting"**, **"Completed"** and **"Stopped"**.
- Standard **bold text** is used to highlight glossary items, defined items inside a table and definitions of local terms. Examples are **JDF** and **JMF** which are used when discussing either the specification in general or an instance document.
- Internal cross-reference links are denoted by a red triangle followed by gray text. An example is 'see ▶ Section 1.3.2 Text Styles'.
- External hyperlinks are denoted by blue underlined text. An example is <http://www.cip4.org>.



Extended Backus-Naur Form

The Extended Backus-Naur Form (EBNF) provides a compact notation that is commonly used in the specifications of programming languages. The official EBNF standard, ▶ [ISO14977:1996], is available from ISO.

1.3.3 XPath Notation Used in this Specification

New in JDF 1.2

A simple subset of the XPath Language ▶ [XPath] is used throughout this specification in the description of an element, attribute or value to identify other elements, attributes and/or values. XPath gets its name from its use of a path notation (as in URLs) for navigating through the hierarchical structure of an XML document. The simple subset of XPath used is:

- Element ▶ Subelement hierarchy is indicated by a slash, e.g. "**Element/Element**".
- Element attribute hierarchy is indicated by a slash and an @ symbol, e.g. "**Element/@Attribute**".
- The text styles above in Section 1.3.1 are used to indicate whether an element is a resource, process or other element, or if the subject is an attribute or a value (ex., enumeration, string, etc.).
- Paths beginning with a single slash: "/" indicate root elements, e.g. **/JDF** indicates the root ▶ JDF Node.
- Paths beginning with a double slash "//" indicate elements with any parent e.g. **//GeneralID** indicates a **GeneralID** element in any element.
- Paths containing square brackets that enclose a predicate describe an element that is restricted by the predicate. This document uses three types of predicates as described in the next 3 items:
 - E[@A="V"] – the XPath specifies an element **E** whose attribute **A** has the value **V** (e.g., **Component[@ComponentType = "FinalProduct"]** specifies a **Component** whose **@ComponentType** has the value of **"FinalProduct"**). The predicate can be used outside the context of an element, e.g. **@ComponentType = "FinalProduct"** (or without the "@": **ComponentType = "FinalProduct"**) means that the **@ComponentType** value equals **"FinalProduct"**).
 - E[contains(@A="V")] – the XPath specifies an element **E** whose attribute **A** has some value that contains **V**, **A**'s value is either an enumerations or NMTOKENS and **V** is an enumeration or NMTOKEN. For example, **Contact[contains(@ContactTypes = "Delivery")/Address]** specifies the **Address** of a **Contact** whose **@ContactTypes** value contains **"Delivery"** and possibly other NMTOKEN values. The predicate can be used outside the context of an element, e.g. **contains @ContactTypes = "Delivery"** means that **@ContactTypes** value contains **"Delivery"**.
 - E[@A] – the XPath specifies an element **E** in which attribute **A** is present, e.g. **Layout[@Side]** specifies a **Layout** in which the **@Side** attribute is present.

Example 1.1: XPath Expression

The XPath expression:

- **Layout/MarkObject/DynamicField/@Format = "Replacement Text for %s and %s go in here at %s on %s" ...**

Means:

- The value **"Replacement Text for %s and %s go in here at %s on %s"** of the **@Format** attribute of the **DynamicField** ▶ Subelement of the **MarkObject** element of the **Layout** resource element.

Locally, (and within context), just the basic attribute dependency is noted (for instance — **DynamicField/@Format**) where the discussion occurs within the section describing the element (e.g., **DynamicField** in our example) elements or the element's immediate parent (e.g., **MarkObject** in our example).

1.3.4 Modification Notes

New in JDF 1.2

To help the reader familiar with earlier versions of **JDF**, this specification indicates additions, deprecations and clarifications using the callouts described in ▶ Table 1.1 Modification Notes. Please note that not all changes are identified with

modified callout flags. When modification occurs in multiple versions, only the most recent version is indicated. A few changes have been made globally and are explained in the body of the document and only significant changes have been flagged with callouts, as determined by CIP4 Working Groups.

Note: Some items that have been deprecated have been removed from the current version of the specification. In such cases it is not possible to link to the original description, however the normal text style as described in ▶ Section 1.3.2 Text Styles is retained, e.g. **PartStatus**. If necessary the reader should refer to a previous version of the specification for a full description.

Table 1.1: Modification Notes

EXAMPLE	CALLOUT MEANING
New in JDF 1.x	New sections, attributes/elements and attribute values.
Deprecated in JDF 1.x	Deprecated sections, attributes/elements and attribute values. Usually there is a deprecation note describing the mechanism that replaces the deprecated item.
Modified in JDF 1.x	Changed syntax or semantics of sections or attributes/elements. Might include clarification as well. Frequently there is a modification note describing the change.

1.3.4.1 Location of Modification Notes

New in JDF 1.4

A callout occurs after one of the following document elements.

- **Section head:** applies to entire section and the contained table (if any).
- **Attribute/Element name:** applies to entire row for the designated attribute/element.
- **Attribute value:** applies to attribute value.

1.3.5 Specification of Cardinality

The cardinality of **JDF** attributes and elements is expressed using a simple Extended Backus-Naur Form (EBNF) notation.

The symbol T in the table below represents an attribute or element. The symbol T consists of either a single name, such as “**RunList**” or an element name followed by a parenthesized name, such as “**RunList (Document)**”. The name in parentheses “**Document**” identifies a particular element instance when several of the same type exist in some context. For further details, see ▶ Section 6.1 Process Template and ▶ Section 1.3.7 Template for Tables that Describe Elements.

Table 1.2: Cardinality Symbols

NOTATION	DESCRIPTION
T	T SHALL occur exactly once and represents an attribute or element.
T ?	T is OPTIONAL or is REQUIRED only in the circumstances explained in the description field. T represents an attribute or element. If T is an attribute, a default that is specified in the description will not be inserted into the XML by a schema aware parser if no value is explicitly specified.
T +	T occurs one or more times, and represents an element.
T *	T occurs zero or more times, and represents an element.
T = "V"	T is an OPTIONAL attribute, but has the specified default value v when T is not supplied. T MAY be set to other values other than the default. A default that is specified as T = "V" indicates a JDF default which SHALL be inserted into the XML by the JDF validator if no value is explicitly specified. If no schema is used in validation, it is up to the application to apply these defaults. See ▶ Section 1.5.2.1 Conformance Requirements for Support of Attributes and Attribute Values. This notation is only valid for XML attributes, not XML elements.

1.3.6 Template for Narrative Description of Resources

Each section for a resource begins with a brief narrative description of the resource. Following that is a list containing details about the properties of the resource, as shown below.

Resource Properties

Resource Class:	Defines the resource class or specifies resource element if the element only exists as a resource subelement.
Resource referenced by:	List of parent resources that may contain elements or references to elements (IDREF or IDREFS attributes) of this type.
Example Partition	List of recommended partition keys: For a complete list of partition keys, see the description of @PartIDKeys in ▶ Table 3.21 Partitionable Resource Element . Note: Resources may be partitioned by keys that are not specified in this list.
Input of Processes:	List of JDF node types that use the resource as an input resource.
Output of Processes:	List of JDF node types that create the resource as an output resource.

The first item in the above list provides the class of the resource. As was described in [▶ Section 3.8.5 Resource Classes](#), all resources are derived from one of the following seven superclasses: *Intent*, *Parameter*, *Implementation*, *Consumable*, *Quantity*, *Handling* and *Placeholder*. All resources inherit additional contents (i.e., zero or more attributes or zero or more elements) from their respective superclasses, and those attributes and elements are not repeated in this section. Thus those attributes associated with a resource of class *Parameter*, for example, can be found in [▶ Table 3.8 Abstract Resource Element](#). Note that this inheritance is only valid for atomic resources (i.e., resources that reside directly in a [ResourcePool](#)).

Resource elements are listed in separate sections if they can be referenced by more than one resource. For an example, see the resource element [SeparationSpec](#). If the resource is not referenced by multiple resources, it is described inside the resource section of the resource to which it belongs. For example, see the structure of the [BundleItem](#) element of the [Bundle](#) resource. If an element inside a resource section of the resource is needed to be referenced by multiple resources in a revision of **JDF**, then that element is promoted to its own section. For example, [ColorSpaceConversionOp](#) was a subelement of [ColorSpaceConversionParams](#) in **JDF/1.1**. The resource class of an atomic resource also defines the superclasses from which the resource inherits additional contents. The [Consumable Resource](#), [Quantity Resource](#) and [Handling Resource](#) inherit from the [PhysicalResource](#) element, which in turn inherits from the resource element. The [Parameter Resource](#) and [ImplementationResource](#) elements inherit from the resource element directly. Non-atomic resources (i.e., resource subelements) do not inherit contents from resource superclasses.

Examples for resources that can be used as atomic resources or resource elements are: [Employee](#), [InsertSheet](#), [LayoutElement](#) and [Media](#).

After the list describing the resource properties, each section contains tables that outline the structure of each resource and, when applicable, the abstract or subelement information that pertains to the resource structure. The first column contains the name of the attribute or element. In some cases, a resource will contain multiple elements of the same type. If this is the case, the element name is listed as often as it appears, along with a term in parentheses that identifies the occurrence. For an example, see [▶ Section 8.54 EndSheetGluingParams](#). The following sections provide templates of the tables.

1.3.7 Template for Tables that Describe Elements

Resources and elements are defined by their attributes and sub-elements.

Note: For tables that describe resources or elements:

- the italicized text describes the actual text that would be in its place in an actual resource definition
- Cardinality* in the Name column refers to a cardinality symbol, which is either empty or consists of a symbol, such as “?”. Examples described by the Name column include: “[Media](#)*” and “[Component \(Proof\)](#)?”. For further details, see [▶ Section 1.3.5 Specification of Cardinality](#).
- The text following a “Note:” in a table field gives further information about the specified table row.

Table 1.3: Template for Element Descriptions (Sheet 1 of 2)

NAME	DATA TYPE	DESCRIPTION
<i>Attribute-Name</i> Cardinality	Attribute- data-type	Information about the attribute.
<i>Element-Name</i> Cardinality	element	Information about the element. Note: The “element” data type means that the specified element SHALL be an in-line subelement within the Resource .

Table 1.3: Template for Element Descriptions (Sheet 2 of 2)

NAME	DATA TYPE	DESCRIPTION
Element-Name Cardinality	refelement	Information about the element Note: The “refelement” data type means that the specified element is based on other atomic resources or resource elements. The specified element SHALL be either an in-line element or an instance of a ResourceRef element (see ▶ Section 3.10.2 ResourceRef – Element for Inter-Resource Linking and reelement). In case of a ResourceRef element, a “Ref” SHALL be appended to the name specified in the table column entitled “Name”.
FileSpec (someValue) Cardinality	refelement	Information about the FileSpec resource. Note: FileSpec / @ResourceUsage SHALL match the “someValue” value specified in the parentheses. When a resource potentially contains multiple FileSpec children, the value of FileSpec / @ResourceUsage is used to distinguish them.
Resource-Name (someValue) Cardinality	refelement	Information about the resource and the attribute whose value is “someValue”. Note: Some specified attribute in the specified resource SHALL match the “someValue” value specified in the parentheses. When a resource potentially contains multiple children of the same resource type, the value of some attribute distinguishes the resources.

1.4 Glossary

The following terms are defined as they are used throughout this specification. For more detail on job and workflow components, see ▶ Section 2.2 System Components.

Table 1.4: Glossary (Sheet 1 of 6)

TERM	DEFINITION
Abstract	Abstract is used as a modifier for Elements and Resources (e.g., Abstract Element , Abstract Resource and Abstract Physical Resource).
Abstract Element	An Abstract Element is an abstract data type with Attributes and Elements that are inherited by a concrete subclass Element . For example, PlacedObject is an Abstract Element member of a Layout . MarkObject and ContentObject elements are concrete Elements of PlacedObject that are themselves potential members of Layout
Abstract Resource	An Abstract Resource is an abstract data type with Attributes and Elements that are inherited by all ▶ Resources. For example, Media , as a Resource inherits all the Attributes and Elements of the Abstract Resource . Abstract Resource has subclasses, such as Abstract PhysicalResource and Abstract ImplementationResource .
Acknowledge Message	An Acknowledge Message is a JMF Message that is delayed response to a Command Message or Query Message .
Agent	The component of a JDF based workflow that writes JDF .
Allowed values are	The phrase “ Allowed values are: ” precedes the complete (closed) list of values for an Attribute whose values are enumeration or enumerations.
Allowed values are from	The phrase “ Allowed values are from: ” precedes a reference to the values. The reference may be an XPath to a value or a reference to a table of attribute values. The referenced values are as complete (closed) as the reference says they are.
Attribute	An XML syntactic construct describing an unstructured characteristic of an Element . See ▶ [XML] for details.
Attribute Value	The value of an Attribute .
Binding Side	The edge on which the (partial) product is glued or stitched. This edge is also often called <i>working edge</i> or <i>spine</i> . The binding side of a signature is defined as the last fold.

Table 1.4: Glossary (Sheet 2 of 6)

TERM	DEFINITION
Class	A set of complex data types with common content in an object-oriented sense. A complex data type consist of zero or more Elements and zero or more Attributes . Each Resource belongs to a Class : " Consumable ", " Handling ", " Implementation ", " Intent ", " Parameter ", " PlaceHolder ", " Quantity ". See Consumable Resource , etc. Each Notification Audit Element belongs to a Class : " Event ", " Information ", " Warning ", " Error ", " Fatal ".
Combined Process	A Process which is described by multiple simpler JDF processes.
Combined Process Node	A Node that represents a Combined Process , which is described by multiple simpler JDF processes. See Combined Process , Node and ▶ Section 3.3 Common Node Types.
Command Message	A Command Message is a JMF Message that requests its recipient to change its state.
Consumable Resource	A Consumable Resource is consumed during a Process . See Resource , Physical Resource and ▶ Section 3.8.5.4 Consumable Resource.
Controller	The component of a JDF based workflow that initiates Devices , routes JDF , and communicates status information.
Default	Used to indicate the Attribute Value that a JDF Consumer SHALL use if an OPTIONAL Attribute (as indicated by a "?" or <code>@Attribute = "DefaultValue"</code> in this specification) has been omitted from a JDF instance. See ▶ Section 1.5.2.1 Conformance Requirements for Support of Attributes and Attribute Values.
Default behavior	The phrase " Default behavior: " precedes a description of the default behavior for an Attribute or Span ▶ Element.
Default value is	The phrase " Default value is: " precedes the default value for an Attribute .
Default value is from	The phrase " Default value is from: " precedes a reference to a default value – usually an XPath.
Deprecated	Indicates that a JDF Element is being phased out of JDF usually in favor of newer JDF ▶ Element(s). It is RECOMMENDED that an Agent does not include such a JDF Element in a JDF instance. Such an indicated JDF Element might be removed from a future version of the JDF specification. JDF Consumers SHOULD only support such JDF Elements for backward compatibility with previous versions of JDF . Deprecated items are flagged with Deprecated in JDF 1.x in this specification.
Device	The component of a JDF workflow part that interprets JDF and executes the instructions. If a Device controls a Machine , it does so in a proprietary manner. For details, see ▶ Section 2.2.2.2 Device about devices in workflow components.
Document Set	A set of Instance Documents presumed to be related.
Element	An XML-based syntactic construct describing structured data in JDF .
Enumeration	A data type that represents a closed set of values, which are specified in this document.
Face Side	The opening side of the (partial) product. This edge is opposite to the binding side.
Finished Page	A page of a final product that normally has no folds inside. The folds of the finished product for packaging (e.g., folding letters into an envelope), or Z-fold of an oversized book, have no effect on the Finished Page definition.
Folio	A numbered Finished Page of a printed book or publication. (Pages are not all necessarily numbered. A 72-page book might have 68 pages that are numbered, which are referred to as either " Folio pages " or " Folios. ")
Form	A collection of imposed (ordered) Finished Pages set for printing or imaging to plate or film. See also Signature .
Gear Side	Gear Side is the side of a Machine , where the drives and gear are mounted. Gear Side is opposite to Operating Side .

Table 1.4: Glossary (Sheet 3 of 6)

TERM	DEFINITION
Gray Box	A Gray Box specifies a loose combination of several Processes with a specific goal. A Gray Box does not specify all Processes or all Resources – except for Output Resources . In a JDF instance, a Process Group with an <code>@Types</code> attribute and no child Nodes represents a Gray Box .
Handling Resource	A Handling Resource is used during a Process , but is not destroyed by that process. See Resource , Physical Resource and ▶ Section 3.8.5.6 Handling Resource.
Implementation Resource	An Implementation Resource defines a Device or operator that executes a given Node . See Resource and ▶ Section 3.8.5.3 ImplementationResource.
Input Resource	A resource is an input to a Process . See Resource .
Instance Document	A document that is part of the output of a job. This generally refers to personalized printing jobs. Each of the individual documents produced from the same input template is referred to as an Instance Document . For example, in a credit card statement run, each statement is an Instance Document .
Intent Resource	An Intent Resource defines the details of products to be produced without defining the process to produce them. See Resource and ▶ Section 3.8.5.2 Intent Resource.
JDF	Job Definition Format. The overall name of this specification. There is also a JDF Element , which is a top-level Element within JDF that encompasses a Node (see below).
JDF Consumer	A Device , Controller or Agent that consumes JDF instances.
JDF Node	See Node .
JMF	Job Messaging Format. Transfers information between MIS , Controllers and Devices . See ▶ Chapter 5 Messaging.
JMF Message	A JMF Message is synonymous with Message .
Job	A hierarchical tree structure comprised of Nodes . Describes the output that is desired by a customer.
Job Part	One or more Nodes which comprise the smallest level of control of interest to MIS .
Jog Edge	The jog edge of a signature is defined as the last fold that is perpendicular to the Binding Side . If there is no fold that is perpendicular to the Binding Side , then the jog edge is the edge on the bottom when the folded signature is not flipped after the final fold.
Leaf	Both the recto and verso Finished Pages on one piece of paper with “leaves” being the plural usage.
Link	A pointer to information that is located elsewhere in a JDF document or that is located in another document.
Machine	The part of a device that does not know JDF and is controlled by a JDF Device in a proprietary manner.
Message	The XML element that Devices and Controllers use to exchange queries, commands, responses, etc. among themselves using HTTP as the underlying protocol and JMF Message Family .
Message Family	A Message Family is a set of messages. The 6 Message Families are Query Message , Command Message , Registration Message , Response Message , Acknowledge Message and Signal Message .
MIS	Management Information System. The functional part of a JDF workflow that oversees all Processes and communication between system components and system control. MIS is assumed to be a role rather than an individual application. A single application may fulfill various roles of an MIS and various roles of an MIS may be implemented by multiple applications.

Table 1.4: Glossary (Sheet 4 of 6)

TERM	DEFINITION
NamedFeature	<p>The term NamedFeature describes a value that is identified by a name using JDF/GeneralID[@DataType = "NamedFeature"]. The value is specified by GeneralID/@IDValue, and the name is specified by GeneralID/@IDUsage. For example, the GeneralID with @IDUsage="a1" and @IDValue="a2 b2" and @DataType="NamedFeature" is a NamedFeature with a value "a2 b2" that is identified by the name "a1". GeneralID/@IDValue is defined as a string.</p> <p>Note: @IDValue has a type of string and therefore whitespace is allowed in the value.</p>
Node	<p>The JDF element type detailing the Resources and Process specification needed to produce a final or intermediate product or Resource. A Node is also called a JDF Node.</p>
Operating Side	<p>Operating Side is the side of a Machine, where the operator works. Operating Side is opposite to Gear Side.</p>
Output Resource	<p>A resource that is an output from a Process. See Resource.</p>
Parameter Resource	<p>A Parameter Resource defines the details of Processes, as well as any non-physical computer data such as files used by a Process. See Resource and ▶ Section 3.8.5.1 Parameter Resource.</p>
Page	<p>When Page occurs by itself, not in the context of Finished Page or Reader Page, it means "Finished Page".</p>
Partition	<p>A Partition is a node of a Partitioned Resource structure. A leaf node Partition represents a single Resource. A non-leaf node Partition represents a set of Resources. Values of the @PartIDKeys Attribute in the Partitioned Resource root specify the Attributes used to identify the individual Resources in the Partitioned Resource. Each Partition except the Partitioned Resource root has a Partition Key Attribute whose value identifies the Partition. See ▶ Table 3.21 Partitionable Resource Element.</p>
Partition Key	<p>A Partition Key is an enumeration value of the @PartIDKeys Attribute and a Partition Key is an Attribute that with can identify a Partition or can reference a Partition from within a Part Element. See ▶ Section 3.10.6 PartIDKeys Attribute and Partition Keys.</p>
Partition, to	<p>The verb to Partition means to construct a Partition Resource from a set of Resources of the same Class. See ▶ Section 3.10.5.4 Partitioning of Resource Subelements.</p>
Partitionable Resource	<p>A Resource that can become a Partitioned Resource.</p>
Partitioned Resource	<p>A Partitioned Resource is a structured Resource that describes a set of Resources, all of the same Class and representing multiple physical or logical entities (e.g., a set of ExposedMedia that represent multiple separated plates).</p>
PDL	<p>Page Description Language. A generic term for any language that describes pages that might be printed. Examples are PDF®, PostScript® or PCL®.</p>
Phase	<p>A Phase is a distinct part of a Workstep such as setup, production or cleanup.</p>
PhysicalResource	<p>A PhysicalResource is a resource whose Class is "Consumable", "Quantity" or "Handling" is considered a PhysicalResource. See ▶ Resource and ▶ Section 3.8.5.7 PhysicalResource.</p>
Process	<p>An individual step in the workflow.</p>
Process Group	<p>A group of Processes. See Process and Process Group Node.</p>
Process Group Node	<p>A Node that contains multiple child Nodes. See Process Group, Node and ▶ Section 3.3 Common Node Types.</p>
Process Node	<p>A Node that describes an individual Process. See Node and ▶ Section 3.3 Common Node Types.</p>
Product Intent	<p>Describes the end result that a customer is requesting. See Product Intent Node.</p>
Product Intent Node	<p>A Node that describes intent rather than specifying the Process. See Node, Product Intent and ▶ Section 3.3 Common Node Types.</p>

Table 1.4: Glossary (Sheet 5 of 6)

TERM	DEFINITION
Quantity Resource	A Quantity Resource has been created by a Process from either a Consumable Resource or an earlier Quantity Resource . See Resource , PhysicalResource and ▶ Section 3.8.5.5 Quantity Resource.
Query Message	A Query Message is a JMF Message that requests its recipient to provide information, but not change its state.
Queue	A Queue is a representation of a Device that receives, manipulates and stores multiple Queue Entry items for execution.
Queue Entry	A Queue Entry is a the representation of an individual ▶ JMF process in a Queue . A Queue Entry MAY be comprised of multiple Workstep processes.
Reader Page	A logical page as perceived by a reader, for example one RunList entry. One Reader Page might span more than one Finished Page (e.g., a centerfold). One ▶ Finished Page might contain contents defined by multiple Reader Pages (e.g., NUp imposition. Reader Pages are defined independently of ▶ Finished Pages).
Registered Side	A side on which a collection of sheets or partial products is aligned during a production step. All production steps require two registered sides, which SHALL NOT be opposite to each other. The two registered edges define the origin of the coordinate system used within the production step. When there is a binding edge, this is one of the registered sides.
Registration Message	A Registration Message is a JMF Message that requests its recipient to send a Command Message to some other recipient.
Resource	A physical or conceptual entity that is modified or used by a Node . Examples include paper, images or Process parameters.
ResourceLink	An Element that links to a Resource . See Resource and ▶ Section 3.9.2 ResourceLink.
Response Message	A Response Message is a JMF Message that functions as a synchronous response to a Command Message or Query Message .
Roll	A Roll is media that is mainly used in connection with Web printing. In British English the name “reel” for “roll” is in widespread use. Roll is used as synonym of reel. Also, see the term Web in this glossary.
Root Node	The top most JDF Node . See Node .
Sheet	<p>The printer’s ▶ Roll of paper or paper cut for press size, with “recto” and “verso” forms for identification of orientation through the press (facing up versus facing down at the feeder or off the ▶ Roll).</p> <p>▶ Sheets are press sheets which may be comprised of multiple folding signatures and might also have “recto” and “verso” forms for identification of orientation through the press (facing up versus facing down at the feeder or off the roll).</p> <p>The term “cut sheet” refers to an individual Sheet, typically in a phrase, such as “separately cut Sheets of an opaque material”. The term “Sheet-Fed” is used to describe a press that consumes cut Sheets, typically in the phrase “Sheet-Fed Press”.</p>
Signal Message	A Signal Message is a JMF Message that is sent asynchronously when some event occurs.
Signature	<p>A Signature is a set of printed Sheets that are folded or yet to be folded.</p> <p>Note that there are multiple usages of the word Signature in the industry. A ▶ Sheet MAY contain multiple BinderySignature ▶ Resources that are the input to folding. This is the standard usage in conventional printing, where multi-page Sheets are printed and potentially cut into multi-page imposition signatures before folding. The Layout Resource, on the other hand, describes a Signature as a set of Sheets. This is appropriate for digital printing, where typically only one or two pages are printed per Sheets-Surface and multiple Sheets are gathered prior to folding.</p>
Slave Controller	The component of a JDF workflow that accepts JDF as a Device from other Controllers and/or Slave Controllers and sends JDF to other Slave Controllers and/or Devices .
Subelement	A child Element of some other Element .

Table 1.4: Glossary (Sheet 6 of 6)

TERM	DEFINITION
Subnode	A Node that is a child of some other Node .
Support	A JDF Consumer Supports a JDF syntactic construct (Processes, Resources, Elements, Attributes and Attribute Values) if the JDF Consumer performs the action defined in this specification for the JDF construct when consuming a JDF instance that includes the JDF syntactic construct. If the Machine that a Device is representing Supports a feature which is represented by a JDF construct, then the Device SHOULD Support that JDF syntactic construct.
Surface	A single side of a Sheet .
Tag	A syntactic XML construct that marks the start or end of an Element .
Unique	The word “Unique” without further scope details means “Unique within the job, message or file depending on the context”. Possible scopes are: Unique within the machine (e.g., ProductionPath/@ProductionPathID). Unique within the workflow – This covers the whole scope at one installation (e.g., StatusQuParams/@JobID , FileSpec/@UID , Device/@DeviceID and @CreationID (in document properties)). Unique within the site – A site is a physical organization entity within a company (printing plant, finishing subcontractor) (e.g., Employee/@PersonalID). It is NOT the Contact/Company used for customers! Unique within the company – Identification of a company or contact SHALL be unique within the company’s database because it can be used on multi tenant systems like web approval) (e.g., Contact[(@ContactTypes, "Approver")]/@ProductID).
Values include	The phrase “ Values include: ” precedes an open list of values for an Attribute whose values are of type NMTOKEN, NMTOKENS, string, NameSpan or StringSpan . The list includes recommended values but does not preclude potential vendor or customer extensions.
Values include those from	The phrase “ Values include those from: ” precedes a reference to the open list of values. The reference may be an XPath to a value or a table of Attribute Values . The referenced values do not include potential vendor or customer extensions.
Web	A Web is media that comes from a Roll and is mainly used in connection with Web printing. This specification uses the word “Web-Fed” instead of “roll-fed” It uses the phrase “Web Printing” and “Web Press” to describe printing presses that consume media from a Roll .
Work Center	An organizational unit, such as a department or a subcontracting company, that can accomplish a task.
Workstep	A workstep is an individual JMF process that can be processed on a single device in one pass. A workstep is comprised of one or multiple parts such as setup, production or cleanup.

1.5 Conformance

1.5.1 Conformance Terminology

The words “SHALL”, “SHALL NOT”, “REQUIRED”, “SHOULD”, “SHOULD NOT”, “RECOMMENDED”, “MAY”, “NEED NOT” and “OPTIONAL” are used in this specification to define a requirement for the indicated **Agent** or the indicated **JDF Consumer** as follows.

Table 1.5: Conformance Terminology (Sheet 1 of 2)

TERM	MEANING
SHALL or REQUIRED	Means that the definition is an absolute requirement of the specification.
SHALL NOT	Means that the definition is an absolute prohibition of the specification.

Table 1.5: Conformance Terminology (Sheet 2 of 2)

TERM	MEANING
SHOULD or RECOMMENDED	Means that there might exist valid reasons in particular circumstances for an implementer to ignore a particular item, but the implementer SHALL fully understand the implications and carefully weigh the alternatives before choosing a different course.
SHOULD NOT or NOT RECOMMENDED	Means that there might exist valid reasons in particular circumstances when the particular behavior is acceptable or even useful, but the implementer should fully understand the implications and then carefully weigh the alternatives before implementing any behavior described with this label.
MAY, NEED NOT or OPTIONAL	<p>Means that an item is truly optional. If a ▶ JDF Consumer is using a JDF parser, that parser will supply the default values indicated in this specification, if any, for optional ▶ Attributes that the ▶ Agent has omitted (indicated by @Attribute = "DefaultValue" in this specification). See ▶ Section 1.3.5 Specification of Cardinality.</p> <p>For features that are optional for a ▶ JDF Consumer to ▶ Support, one vendor might choose to ▶ Support such an item because a particular marketplace requires it or because the vendor feels that it enhances the product, while another vendor might omit ▶ Support of that item. Similarly, one vendor of an ▶ Agent might choose to supply such an item in a JDF instance, while another vendor might omit the same item in a JDF instance. A ▶ JDF Consumer implementation which does not include ▶ Support of a particular option (element or attribute) SHALL be prepared to interoperate with an ▶ Agent implementation which does supply the option, though with reduced functionality. In the same vein, a ▶ JDF Consumer implementation which does include ▶ Support for a particular option SHALL be prepared to interoperate with an ▶ Agent implementation which does not supply the option in the JDF instance.</p>

1.5.2 Conformance Requirements for JDF Entities

The subsections of this section define the general conformance requirements for the **JDF** entities: 1) ▶ Attributes and ▶ Attribute Values, 2) ▶ Resources, 3) ▶ Processes, and 4) ▶ Combined Processes.

1.5.2.1 Conformance Requirements for Support of Attributes and Attribute Values

If a ▶ JDF Consumer supports an attribute, it SHALL support all of the values that this specification indicates are REQUIRED for a ▶ JDF Consumer to support (whether or not the attribute is REQUIRED for the ▶ Agent to supply in that context). If this specification is silent on which values are REQUIRED for support of an attribute, then the ▶ JDF Consumer SHALL support at least one value in order to claim support for the attribute.

Attributes that are OPTIONAL for an ▶ Agent to include in a **JDF** instance are indicated by a “?” character following the attribute name or by the notation @Attribute = "DefaultValue" as indicated in ▶ Section 1.3.5 Specification of Cardinality.

A Special Note on the Handling of Defaults. Prior to **JDF** 1.2 many OPTIONAL attributes included either explicit default values or the default value was indicated as "system specified" or the "SystemSpecified" enumeration or NMTOKEN value. In **JDF**/1.2, the explicit default values are indicated as default values using the “=” followed by the “value” (See ▶ Section 1.3.5 Specification of Cardinality). The "SystemSpecified" enumeration and NMTOKEN values have been removed and the attribute remains as an OPTIONAL attribute indicated with a “?” with no default value. The **JDF** consuming application SHALL supply the default value when the attribute is omitted from the **JDF** instance. Such an indicated default value SHALL have the same semantic meaning as if an ▶ Agent includes the attribute in the **JDF** instance with the same value. If an OPTIONAL attribute does not have a default value indicated in its description and the **JDF** instance does not include the attribute, then the ▶ JDF Consumer can use a system-specified value.

See ▶ Figure 1-1: Handling of default values of JDF attributes. below. Such a system-specified attribute value can be configurable by a system administrator for the ▶ JDF Consumer or can depend on the values of other supplied attributes and/or the current setting of the ▶ JDF Consumer device or the actual ▶ Machine for which the device is providing a **JDF** interface.

Figure 1-1: Handling of default values of JDF attributes.

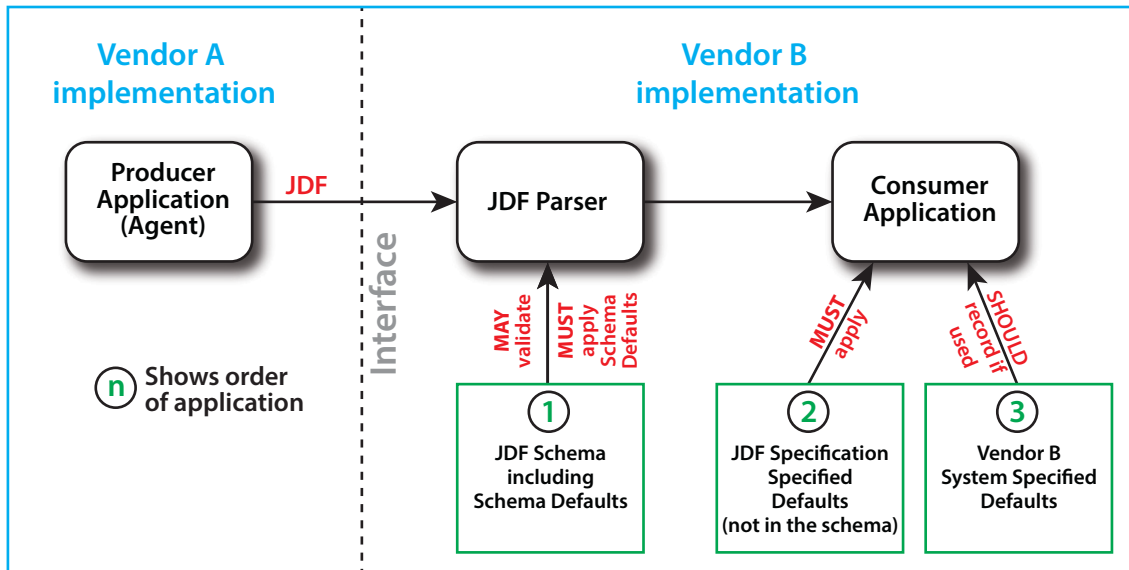

1.5.2.2 Conformance Requirements for Support of Elements

If a ▶ JDF Consumer supports an element, it

- 1 SHALL support all of the attributes (see ▶ Section 1.5.2.1 Conformance Requirements for Support of Attributes and Attribute Values) defined for that element that an ▶ Agent is REQUIRED to include in the element instance, i.e. attributes with either no marks or a “+” as defined in ▶ Section 1.3.5 Specification of Cardinality.
- 2 SHOULD support the `@SettingsPolicy`, `@BestEffortExceptions`, `@MustHonorExceptions` and `@OperatorInterventionExceptions` (see ▶ Section 3.1 Generic Contents of All Elements) attributes and all of their defined values. These attributes control the policy that a ▶ JDF Consumer SHALL follow when it encounters unsupported settings (i.e., ▶ Subelements, attributes or attribute values in the resource).

1.5.2.3 Conformance Requirements for Support of Processes

All processes are OPTIONAL for a ▶ JDF Consumer to support. However, a device SHALL support at least one process or a ▶ Combined Process. If a ▶ JDF Consumer supports a process, it

- 1 SHALL support all of the input and output `ResourceLink` elements and referenced resources as described in ▶ Section 1.5.2.2 Conformance Requirements for Support of Elements that this specification defines for that process,
- 2 MAY make its own assumptions regarding attributes and ▶ Subelements of an OPTIONAL ▶ Input Resource (Resources with either a “?” or an “*” – see ▶ Section 1.3.5 Specification of Cardinality) that an ▶ Agent has omitted from the process in the **JDF** instance; therefore, default attribute values defined in this specification are not guaranteed when the ▶ Agent omits the resource from the process in the **JDF** instance (see ▶ Section 6.1 Process Template), and
- 3 SHOULD find the processes that it supports in a **JDF** instance and SHALL ignore all other processes, independent of the `@SettingsPolicy` attribute for those other processes.

1.5.2.4 Conformance Requirements for Support of Combined Processes

All ▶ Combined Processes are OPTIONAL for a ▶ JDF Consumer to support. The rules for processes specified in ▶ Section 1.5.2.3 Conformance Requirements for Support of Processes apply. If a ▶ JDF Consumer supports a ▶ Combined Process, it

- 1 SHALL support all of the ▶ Input Resources as defined in ▶ Section 1.5.2.2 Conformance Requirements for Support of Elements that this specification defines for the *first* process in the ▶ Combined Process Node (i.e., the first process listed in the `@Types` attribute),
- 2 SHALL support all of the ▶ Output Resources as defined in ▶ Section 1.5.2.2 Conformance Requirements for Support of Elements that this specification defines for the *last* process in the ▶ Combined Process,
- 3 MAY support resources that are used as exchange resources between processes in the process chain of the ▶ Combined Process (i.e., resources that are both produced and consumed within the ▶ Combined Process Node),
- 4 SHALL support resources in intermediate process steps that are *not* used as exchange resources between processes in the process chain of the ▶ Combined Process.

1.5.3 Conformance to Settings Policy

The `@SettingsPolicy`, `@BestEffortExceptions`, `@MustHonorExceptions` and `@OperatorInterventionExceptions` attributes are defined in ▶ Table 3.1 Any Element (generic content). They define the conformance policy of a device. A ▶ JDF Consumer SHOULD support these attributes and all of the defined values so that an ▶ Agent can depend on the ▶ JDF Consumer following the policy requested by the ▶ Agent in a **JDF** instance.

1.6 Data Structures

The following table describes the data structures as they are used in this specification. For more details on **JDF** Schema and data types, see ▶ Appendix A Data Types and Values.

In **JDF** 1.2, some data types have been enhanced to include unbounded values by defining the explicit tokens "INF" and "-INF". For instance, the IntegerRange "0 ~ INF" specifies all positive integers including 0.



Data Types

An important reason for using a W3C Schema is to make use of user-defined data types. Even data types that are defined in the Schema specification have been more narrowly defined in JDF, including boolean (JDF doesn't permit 1, 0), double (JDF doesn't permit NaN), duration (JDF has INF & -INF) and string (JDF doesn't permit CR LF & FF). Be sure to check ▶ Appendix A Data Types and Values for all data type definitions.

Table 1.6: JDF Data Types (Sheet 1 of 3)

DATA TYPE	DESCRIPTION
boolean	Binary-valued logic: (true false).
CMYKColor	Represents a CMYK color specification.
date Deprecated in JDF 1.6	Represents a time period that starts at midnight of a specified day and lasts for 24 hours. Deprecation Note: Unused.
dateTime	Represents a specific instant of time. It SHALL be a UTC time or a local time that includes the time zone.
DateTimeRange	Two <i>dateTime</i> values separated by a “~” (tilde) character that define the closed interval of the two.
DateTimeRangeList	Whitespace-separated list of <i>DateTimeRange</i> values.
double	Corresponds to ▶ [IEEE754] double-precision, 64-bit floating point type, including special tokens INF and -INF. This corresponds to the standard XML double with NaN removed. For details, see ▶ [XMLSchema]. Note: Prior to JDF 1.2 the data type <i>number</i> was used. The <i>double</i> and <i>number</i> data types are syntactically equivalent.
DoubleList New in JDF 1.2	Whitespace-separated list of <i>double</i> values. Note: This data type was named <i>NumberList</i> before JDF 1.2.
DoubleRange New in JDF 1.2	Two <i>double</i> values separated by a “~” (tilde) character that define the closed interval of the two. Note: This data type was named <i>NumberRange</i> before JDF 1.2.
DoubleRangeList New in JDF 1.2	Whitespace-separated list of <i>double</i> and <i>DoubleRange</i> values. Note: This data type was named <i>NumberRangeList</i> before JDF 1.2.
duration	Represents a duration of time.
DurationRange	Two duration values separated by whitespace. Describes a range of time durations. More specifically, it describes a time span that has a relative start and end.
DurationRangeList	Whitespace-separated list of <i>DurationRange</i> values.
element	Structured data. The specific data type is defined by the element name.
enumeration	Limited set of <i>NMTOKEN</i> values (see below).
enumerations	Whitespace-separated list of <i>enumeration</i> values.

Table 1.6: JDF Data Types (Sheet 2 of 3)

DATA TYPE	DESCRIPTION
gYearMonth Deprecated in JDF 1.6	Represents a specific Gregorian month in a specific Gregorian year. Deprecation Note: Unused.
hexBinary	Represents arbitrary hex encoded binary data.
hexBinaryList New in JDF 1.4	Whitespace-separated list of <i>hexBinary</i> values.
ID	Unique identifier as defined by ▶ [XML] (see ▶ Section 1.3.1 Document References). SHALL be unique within the scope of the JDF document.
IDREF	Reference to an element holding the unique identifier as defined by [XML Specification 1.0].
IDREFS	List of references (IDREF values) separated by white spaces as defined by ▶ [XML].
integer	Represents numerical integer values, including the special tokens INF and -INF. This corresponds to the standard XML integer with INF and -INF added. Values greater than $\pm 2^{*}31$ are not expected to occur for this data type. For details, see ▶ [XMLSchema].
IntegerList	Whitespace-separated list of <i>integer</i> values.
IntegerRange	Two <i>integer</i> values separated by a “~” (tilde) character that define a closed interval.
IntegerRangeList	Whitespace-separated list of <i>integer</i> values and <i>IntegerRange</i> values.
LabColor	Represents a Lab color specification.
language	Represents a language and country code (for example, en-US) for a natural language. Values SHALL conform to ▶ [RFC3066].
languages New in JDF 1.4	Whitespace-separated list of <i>language</i> values.
LongInteger	Represents numerical integer values, including the special tokens INF and -INF. This corresponds to the standard XML integer with INF and -INF added. Values greater than $\pm 2^{*}31$ are expected to occur for this data type. For details, see ▶ [XMLSchema].
matrix	Whitespace-separated list of six doubles representing a coordinate transformation matrix.
NameRange	Two <i>NMTOKEN</i> values separated by a “~” (tilde) character that define an interval of <i>NMTOKEN</i> values.
NameRangeList	Whitespace-separated list of <i>NMTOKEN</i> and <i>NameRange</i> values.
NMTOKEN	A continuous sequence of special characters as defined by ▶ [XML].
NMTOKENS	Whitespace-separated list of <i>NMTOKEN</i> values.
PDFPath	Whitespace-separated list of path operators as defined in PDF.
rectangle	Whitespace-separated list of four doubles representing a rectangle.
refelement	ResourceElement or a reference to an element. Used to define candidates for inter-Resource linking in resources.
regExp New in JDF 1.2	Regular expression as defined by ▶ [XMLSchema].
shape	Whitespace-separated list of three doubles representing a three-dimensional shape consisting of a width, height and length. Unless specified otherwise in the attribute description, these three numbers are an X-dimension, a Y-dimension and a Z-dimension, respectively.
ShapeRange	Two <i>shape</i> values separated by a “~” (tilde) character that defines a 3-dimensional box bounded by $x1\ y1\ z1 \sim x2\ y2\ z2$.

Table 1.6: JDF Data Types (Sheet 3 of 3)

DATA TYPE	DESCRIPTION
ShapeRangeList	Whitespace-separated list of <i>shape</i> values or <i>ShapeRange</i> values.
Source	jdf or xml.
string Modified in JDF 1.2	Character strings without tabs or line feeds. Corresponds to the standard XML normalizedString data type ▶ [XMLSchema].
text	Text data contained in an XML element (between start and end tag). A few elements, such as Comment , have text, e.g. < Comment >example text</ Comment >.
TimeRange Deprecated in JDF 1.6	Two <i>dateTime</i> values separated by a “~” (tilde) character that defines the closed interval of the two.
TransferFunction	Whitespace separated list of an even number of doubles representing a set of XY coordinates of a transfer function.
URI Modified in JDF 1.3	URI-reference. Represents a Uniform Resource Identifier (URI) Reference as defined in Section 4 of ▶ [RFC3986]. For the “file:” URL scheme, see ▶ [RFC3987]. URI was modified in JDF 1.3 to include Internationalized Resource Identifiers (IRI).
URL Modified in JDF 1.3	URL-reference. Represents a Uniform Resource Locator (URL) Reference as defined in Section 4 of ▶ [RFC3986]. For the “file:” URL scheme, see ▶ [RFC3987]. URL was modified in JDF 1.3 to include usage of Internationalized Resource Identifiers (IRI).
XPath	Represents an XPath expression of an XML node set (attributes or elements), boolean, double or string. ▶ [XPath]
XYPair	Whitespace-separated list of two doubles. Unless specified otherwise in the attribute description, these two doubles are an X-dimension and a Y-dimension, respectively.
XYPairRange	Two <i>XYPair</i> values separated by a “~” (tilde) character that defines a rectangle bounded by x1 y1 ~ x2 y2.
XYPairRangeList	Whitespace-separated list of <i>XYPairRange</i> values.

1.6.1 Units of measurement

JDF specifies most values in default units. This means that an implementation SHALL use the defined default units and SHALL NOT use alternate units.

The supported default units are described in ▶ Table A.4.24 Units which associates measurement types with the default unit. If there is no suitable entry, i.e. when a new resource is defined that introduces a new measurement type not listed in ▶ Table A.4.24 Units, then the processor MAY introduce a new unit, and that unit SHALL be based upon metric units. Speed shall be specified in units (as defined in the previous paragraph) per hour.

1.6.2 Counting in JDF

When accessing data using an index, zero-based indices SHALL be used in **JDF**. Thus the first index is 0, the second index is 1, etc. Negative values SHALL specify a number that is counted from the back of the list. Thus the last item is at index -1, the second to last item is at index -2 etc.

JDF also allows ranges of items to be sub-selected from lists by using a pair of integer values where the first item identifies the start of the selection and the second item identifies the end of the selection. Thus the range “0 -1” represents all entries of a list and the range “-1 0” represents the same list in reverse order.

2 Overview

2.1 Introduction

This chapter explains the basic aspects of **JDF**. It outlines the terminology that is used and the components of a workflow necessary to execute a printing job using **JDF**. Also provided is a brief discussion of **JDF** process structure and the role of messaging in a **JDF** job.

2.2 System Components

This section defines unique terminology used in this specification for the job and workflow components of **JDF**. Links to additional information are included for some terms.

2.2.1 Job Components

This terminology describes how **JDF** is described conceptually and hierarchically.

2.2.1.1 Jobs and Nodes

A **Job** is the entirety of a **JDF** project. Each **Job** is organized in a tree structure containing all of the information needed to complete the intended project. The information is collected logically into what is called a **node**. Each node in the tree structure represents an aspect of the **Job** to be executed.

The nodes in a **Job** are organized in a hierarchical structure that resembles a pyramid. The node at the top of the pyramid describes the overall intention of the **Job**. The intermediate nodes describe increasingly process-oriented aspects of the **Job**, until the nodes at the bottom of the pyramid each describe a single, simple **Process**. Depending on where in the **Job** structure a node resides, it can represent a portion of the product to be created, one or many processing steps or other **Job** parts. For more information about **Jobs** and nodes, see **Section 3 Structure**.

2.2.1.2 Elements

An element is a standard XML syntactic construct **[XML]**. (See also: **Section 2.2.1.3 Attributes**.) Elements that are subparts of other elements are often referred to as subelements. **JDF** elements are used to contain other elements in an ordered hierarchy, to contain a set of associated attributes and (in a few cases) to contain text. For more information about elements, see **Section 3.2 JDF**.



XML Crash Course

Need a crash course in XML? XML101.com provides online tutorials that non-programmers can easily follow. The site includes examples. See **[XML Tutorial]**.

2.2.1.3 Attributes

An attribute is a standard XML syntactic construct **[XML]**. (See also: **Section 2.2.1.2 Elements**.) Attributes are defined as various different data types, such as **string**, **enumeration**, **dateTime** and so on.

For more information about attributes, see **Section 3.2 JDF**. Note that an attribute with an empty (zero length) value string SHALL NOT be specified except when its data type allows an empty string (i.e., if not required, OPTIONAL attributes are to be omitted rather than included as empty attributes).

2.2.1.4 Relationships

The hierarchical **JDF** structure implies relationships between **nodes** and **elements** within a **JDF** tree structure. The terms used in this document to describe these relationships are defined below, and, in some cases, include a brief representation of the encoding that would express them.

- **Parent:** An element that directly contains a child element.
`<Parent><Child/></Parent>`
- **Child:** An element that resides directly in the parent element.
- **Sibling:** An element that resides in the same parent element as another child element.
`<Any>
<Sibling/>
</Any>`
- **Descendent:** An element that is a child or a child of a child, etc.

- **Ancestor:** An element that is a parent or a parent’s parent, etc.

```

<Ancestor>
  <Any>
    <Descendent/>
  </Any>
  <MoreAnys>
    <Descendent/>
  </MoreAnys>
</Ancestor>

```

- **Root:** The single element that contains all other elements as descendents.
- **Leaf:** Element without further child elements.
- **Branch:** An intermediate node in a hierarchy that contains at least one child node. A branch is never a leaf.

2.2.1.5 Links

There are two kinds of links in **JDF**: internal links and external links. Internal links are pointers to information that is located elsewhere in a **JDF** document. The data that is referenced by the link is located in a target element. External links are used to reference objects that are outside of the **JDF** document itself, such as content files or color profiles. These objects are linked using standard URLs (Uniform Resource Locators).

JDF makes extensive use of links in order to reuse information that is relevant in more than one context of the ▶ Job. The same target can be referenced by multiple links. However, no link references more than one target. See ▶ [URI].

2.2.2 Workflow Component Roles

The components that create, modify, route, interpret and execute a **JDF** job are known as agents, controllers, queues, devices and machines. Overseeing the workflow created by these components is MIS or Management Information Systems. These five aspects of a **JDF** workflow are described in the sections that follow.

By defining these terms, this specification does not intend to dictate to manufacturers how to design, build or implement a **JDF /JMF** system. In practice, it is very likely that individual system components will include a mixture of the roles described in the following sections. For example, many controllers are also agents.

2.2.2.1 Machine

A machine is any part of the workflow system designed to execute a process. Most often, this term refers to a piece of physical equipment, such as a press or a binder, but it can also refer to the software components used to run a particular machine or perform a calculation. Computerized workstations, whether run through automated batch files or controlled by a human worker, are also considered machines if they have no **JDF** interface.



Agents, Controllers & Devices

“Agents”, “Controllers” and “Devices” are special, logical descriptions. You probably won’t ever buy one. An Agent (writes and reads JDF) can be any software tool that can parse JDF. Controllers communicate instructions that Devices act upon. They are functions that can be embedded into your software, production equipment or MIS sys-

2.2.2.2 Device

The most basic function of a device is to execute the information specified by an ▶ Agent and routed by a ▶ Controller. Devices SHALL be able to execute ▶ JDF Nodes and initiate ▶ Machines that can perform the physical execution. The communication between machines and devices is not defined in this specification. Devices SHOULD support ▶ JMF messaging in order to interact dynamically with a ▶ Controller.

2.2.2.3 Agent

▶ Agents in a **JDF** workflow are responsible for writing **JDF**. An ▶ Agent has the ability to create or modify a **JDF** node, a ▶ Job, to add ▶ Nodes to an existing ▶ Job, and to modify existing nodes. ▶ Agents can be software processes, automated tools or even text editors. Anything that can be used in composing **JDF** can be considered an ▶ Agent.

Actual implementations of ▶ Devices or ▶ Controllers will most often be able to modify **JDF**. These system components have ▶ Agent properties in the terms of this specification.

2.2.2.4 Queue

Whereas a ▶ Device processes **JDF** to produce a result, queues provide a method of ordering, prioritizing and scheduling queue entries that represent **JDF** processes. Every ▶ Device that is capable of accepting **JDF** via **JMF** messaging SHALL provide exactly one queue. This specification makes no assumptions on implementation limitations of a queue. Thus a device that can only process a single queue entry and cannot store any waiting queue entries still implements an albeit minimalistic queue.

2.2.2.5 Controller

▶ Agents create and modify **JDF** information; controllers route it to the appropriate ▶ Devices. The minimum requirement of a controller is that it can initiate ▶ Processes on at least one ▶ Device, or at least one other slave controller that will then initiate ▶ Processes on a ▶ Device. In other words, a controller is not a controller if it has nothing to control. In some cases, a pyramid-like hierarchy of controllers can be built, with a controller at the top of the pyramid controlling a series of lower-level controllers at the bottom. The lowest-level controllers in the pyramid, however, SHALL have ▶ Device capability. Therefore, controllers SHALL be able to work in collaboration with other controller. In order to communicate with one another, and to communicate with ▶ Devices, controllers SHALL support the **JDF** file-exchange protocol and MAY support ▶ JMF. Controllers can also determine ▶ Process planning and scheduling data, such as ▶ Process times and planned production amounts.



Automating Data Flows

JDF-enabled workflow can require a tremendous amount of information. This could seem daunting to anyone who expects to have to enter information into a system, but it need not be the case. From the style information in a layout file, to automatically generated image file header information, to the color profiles tagged onto images automatically by digital cameras or image editing systems, a great deal of information can be captured and passed along from one JDF-enabled application to another. Furthermore, where, in the specification, there are many options, those options can be set to user-defined default values that represents typical Jobs in your particular workflow. For instance, JDF provides a variety of staple folds. If your plant only supports a crown fold, that becomes the default in your JDF-enabled system and is rarely manually specified or keyed.

2.2.2.6 Management Information System—MIS

The overseer of the relationships between all of the units in a workflow is known as Management Information Systems or MIS. MIS is, in effect, a macrocosmic ▶ Controller. It is responsible for dictating and monitoring the execution of all of the diverse aspects of the workflow. To do this, it SHALL remain in contact with the actual production facilities. This can be accomplished either in real time using ▶ JMF messaging or post facto using the audit records within a returned **JDF**.

To allow MIS to communicate effectively with the other workflow components, **JDF** supplies what is essentially a messenger service, in the form of ▶ JMF, to run between MIS and production. This format is equipped with a variety of ▶ Message types, ranging from simple, unidirectional notification to queries and even commands. System designers have a great deal of flexibility in terms of how they choose to use the messaging architecture, so that they can tailor the ▶ Processes to the capabilities of the existing workflow mechanism. The ▶ Figure 2-1: Example of JDF and JMF workflow interactions depicts how various communication threads can run between MIS and production.

JDF also provides system components the ability to collect performance data for each ▶ Node, which can then be passed on to a job-tracking system for use by the MIS system. These data can be derived from the ▶ Messages that the ▶ Controller receives or from the audit records in the job. For more information on audits, see ▶ Section 3.11.4 Audit. Alternatively, the completed job can be passed to the job accounting system, which examines the audit records to determine the costs of all the processes in the ▶ Job.

2.2.3 System Interaction

An example of the interaction and hierarchical structure of the components considered in the preceding section is shown in the following figure. Single arrows indicate unidirectional communication channels and double arrows indicate bidirectional communication.

Figure 2-1: Example of JDF and JMF workflow interactions

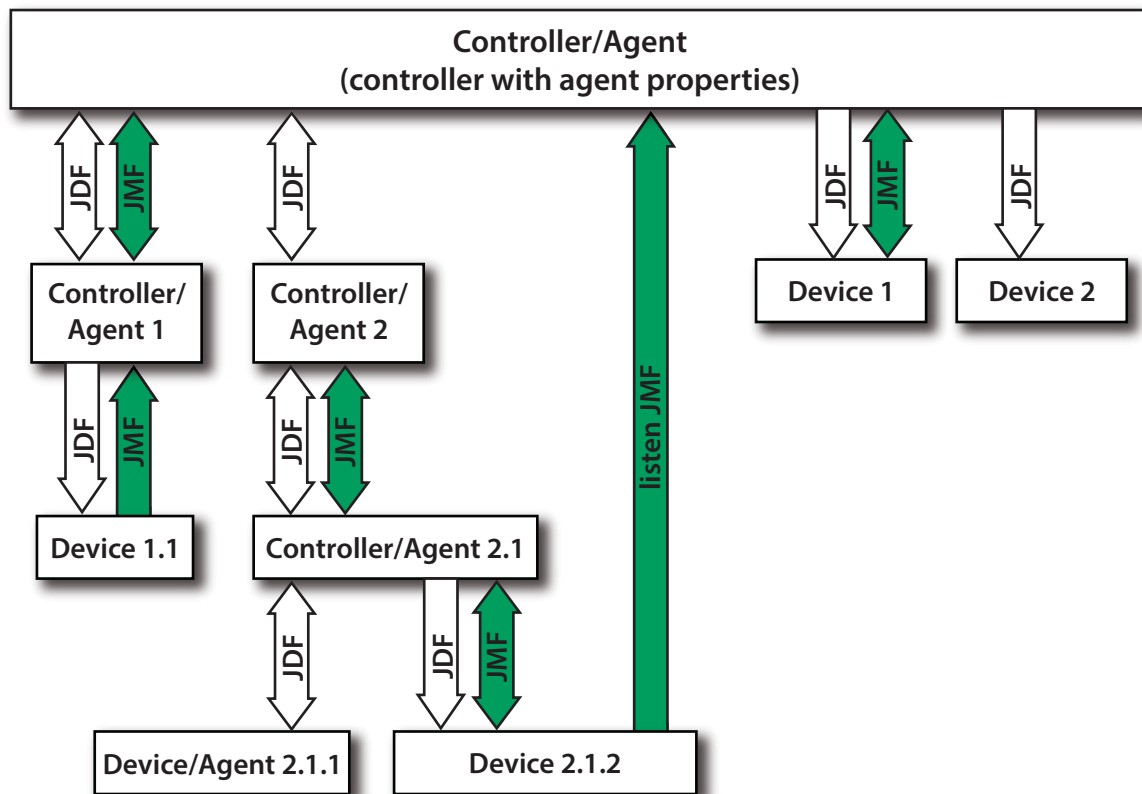

2.3 JDF Workflow

JDF does not dictate that a workflow must be constructed in any particular way. On the contrary, its flexibility has allowed **JDF** to model existing custom solutions for the graphic arts, as well as those yet to be imagined. **JDF** is equally as effective with a simple system using a single controller-Agent and device as it is with a completely automated industrial press workflow with integrated prepress and postpress operations.

Because of workflow system construction in today's industry, the principal subsection procedures of a printing ▶Job—prepress, press and postpress—remain largely disconnected from one another. **JDF** provides a solution for this lack of unity. With **JDF**, a print ▶Job becomes an interconnected workflow that runs from job submission through trapping, RIPping, filmmaking, platemaking, inking, printing, cutting, binding, and sometimes even through shipping. **JDF** enables an architecture that defines the process necessary to produce each intended result and identifies the elements necessary to complete the processes. All processes are separated into nodes, and the entire ▶Job is represented by a tree of these nodes. All of the nodes taken together represent a desired printed product.

Each individual node in **JDF** is defined in terms of inputs and outputs. The inputs for a node consist of the resources it uses and the parameters that control it. For example, the inputs in a node describing the process parameters for imaging the cover of a brochure might include requirements for trapping, raster image processing, and imposing the image. The output of such a node might be a raster image.

Unless they represent the absolutely final product, resources that are produced by one node are in turn modified or consumed by subsequent nodes. For instance, the output of the process described above—the raster image—becomes one of the input resources for a node describing the printing process for the brochure. This input resource would be joined in the node by other input resources such as inks, press sheets, plates and a set of parameters that indicate how many sheets to produce. The output would be a set of printed press sheets that in turn would become the input resource for postpress operations such as folding and cutting. And so on until the brochure is completed.

This system of interlinked nodes effectively unites the prepress, press and postpress processes, and even extends the notion of where a ▶Job begins. A **JDF** job, like any printing job, is defined by the original intent for the end product. The difference between a **JDF** ▶Job and a generic printing job, however, is that **JDF** allows the entire ▶Job, from prepress through postpress, to be defined up front. All of the resources and processes necessary to produce an entire printed product can be identified and organized into nodes before the first prepress process is set in motion. Furthermore, the Product Intent specification can be extremely broad or extremely detailed, or anywhere in between. This means that a ▶Job can be so well defined before production begins that the system administrator only has to set the wheels in motion and let the ▶Job run its course. It might also mean that the person submitting the ▶Job has only a general idea of what the final product will look like and that modifications to the intent will be made along the way, depending on the course of the ▶Job.

For example, the person submitting the ▶ Job specification for the brochure described above might know that she wants 400 copies, that she wants it done on a four-color press with no spot colors, that the cover will be on a particular paper stock and the contents on another, that the binding will be stapled, and that she requires the ▶ Job in two weeks. Another person might know only that he wants the pages she’s designed to be put into some sort of brochure form, although she doesn’t know exactly what. Either person’s request can be translated into a **JDF Product Intent** node that will eventually branch into a tree structure describing each process needed to complete the brochure. In the first example, the prepress, press and postpress processes will be well defined from the start. In the second example, information will be included as it is gathered. The following sections describe the way in which nodes can combine to form a ▶ Job.

2.3.1 Job Structure

JDF ▶ Jobs consist of a set of nodes that specify the production steps needed to create the desired end product. The nodes, in addition to being connected through inputs and outputs, are arranged in a hierarchical tree structure. ▶ Figure 2-2: JDF tree structure, below, shows a simple example of a tree of nodes.

Figure 2-2: JDF tree structure

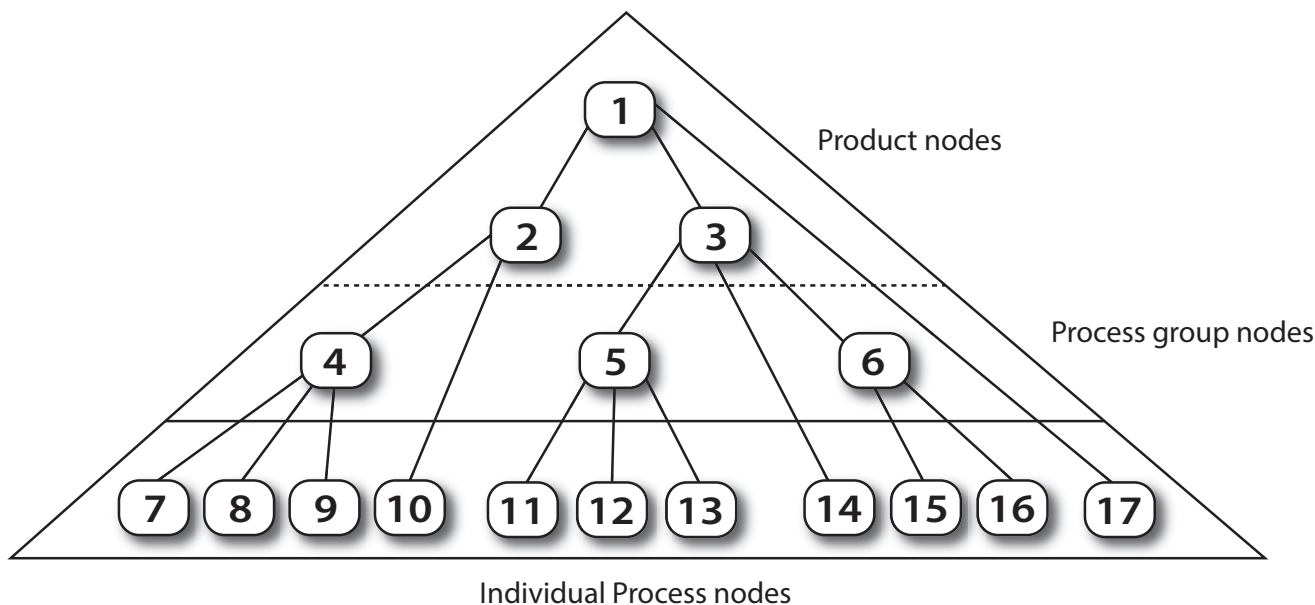

The following table provides a hypothetical breakdown of the nodes in the tree structure shown above.

Table 2.1: Information contained in JDF Nodes, arranged numerically (Sheet 1 of 2)

NODE #	MEANING
1	Entire book
2	Cover
3	Contents
4	Production of cover
5	Production of all color pages
6	Production of all black-and-white pages
7	Cover production Process 1
8	Cover production Process 2
9	Cover production Process 3
10	Cover Finishing Process
11	RIPing for color pages
12	Plate making for color pages

Table 2.1: Information contained in JDF Nodes, arranged numerically (Sheet 2 of 2)

NODE #	MEANING
13	Printing for color pages
14	Color page finishing Process
15	RIPing for black-and-white pages
16	Printing for black-and-white pages on a digital press
17	Binding Process for entire book

The uppermost Nodes (1, 2, & 3) represent the Product Intent in general terms. These nodes describe the desired end product and the components of that product, which, in this case, are the cover and the content pages. As the tree branches, the information contained within the nodes gets more specific. Each subnode defines a component of the product that has a unique set of characteristics, such as different media, different physical size or different color requirements. The nodes that occur in the middle of the tree (4, 5, & 6) represent the groups of processes needed to produce each component of the product. The nodes that occur closest to the bottom of the tree (7–17) each represent individual processes. In this example, there are two subcomponents of the ▶ Job, the cover and the contents, each with distinct requirements. Therefore, two nodes—Nodes 2 and 3—are needed to describe the elements of the ▶ Job in broad terms. Within the content pages there are some black-and-white pages and some color pages. Since fabricating each requires a different set of processes, further branching is necessary. The following table arranges the nodes in groups according to the processes they will be executing.

Table 2.2: Information contained in JDF Nodes, arranged by group

PROCESS GROUP	NODE #	MEANING
Entire book	1	Entire book
	17	Assemble book
Cover	2	Cover
	4	Cover assembly Processes
	7	Cover production Process 1
	8	Cover production Process 2
	9	Cover production Process 3
	10	Finishing Process for cover
Contents	3	Contents
Color Pages	5	Production of all color pages
	11	RIPing for color pages
	12	Plate making for color pages
	13	Printing for color pages
	14	Color page finishing
Black-and-white pages	6	Production of all black-and-white pages
	15	RIPing for black-and-white pages
	16	Printing for black-and-white pages on a digital press

This hierarchical structure is discussed in more detail in the following section.

2.4 Hierarchical Tree Structure and Networks in JDF

Output resources of **JDF** nodes are often the input resources for other **JDF** nodes. Nodes SHALL NOT begin executing until all of their input resources are complete and available. This means that the nodes execute in a well defined sequence. One

process follows the next. For example, a process for making plates will produce, as output resources, press plates that are needed by a **ConventionalPrinting** process.

In the hierarchical organization of a **JDF** ▶ Job, nodes that occur higher in the tree represent high level, more abstract operations, while lower nodes represent more detailed process operations. More specifically, nodes near the top of the tree can represent only intent regarding the components or assemblies that make up the product, while the leaf nodes provide explicit instructions to a device to perform some operation. ▶ Figure 2-3: Example of a hierarchical tree structure of JDF nodes shows an example of a hierarchical structure.

Figure 2-3: Example of a hierarchical tree structure of JDF nodes

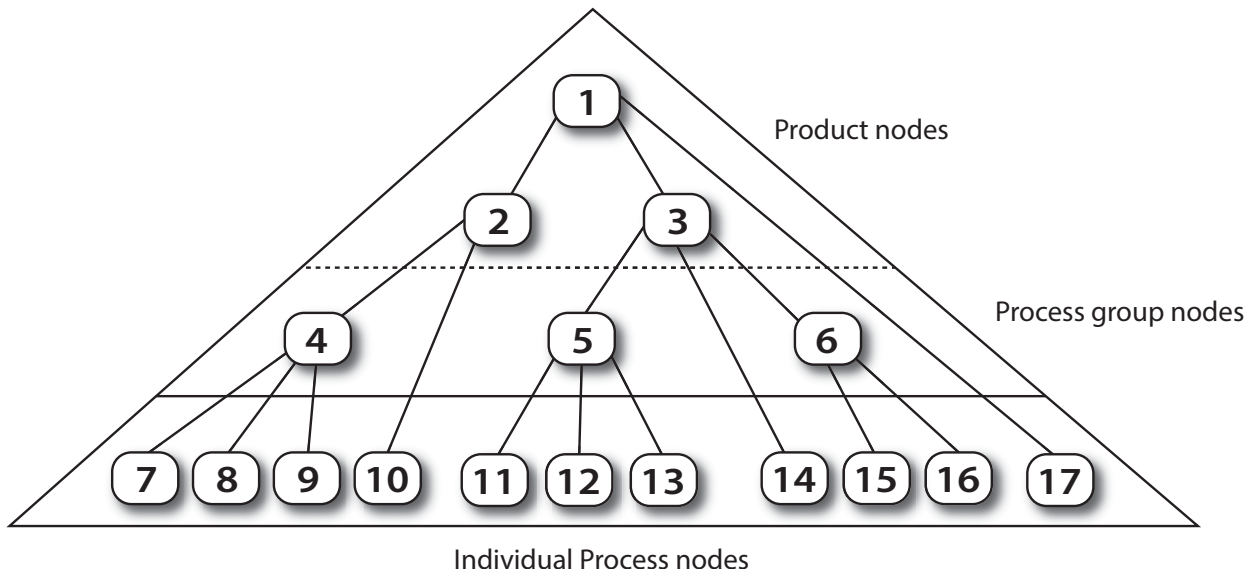

In addition to the hierarchical structure of the node tree, sibling nodes are linked in a process chain by their respective resources. In other words, an output resource of one node ends up representing the input resource of the following node (as represented in ▶ Figure 2-4: Example of a process chain linked by input resources and output resources). This inter-relationship is known as resource linking.

With resource linking, complex networks of processes can be formed. The ▶ Figure 2-4: Example of a process chain linked by input resources and output resources displays an alternate representation of the process described in ▶ Figure 2-3: Example of a hierarchical tree structure of JDF nodes. Whereas ▶ Figure 2-3: Example of a hierarchical tree structure of JDF nodes represents a hierarchical structure, ▶ Figure 2-4: Example of a process chain linked by input resources and output resources shows an example of the linking mechanism of the same ▶ Job. Note that there are many possible process networks that map to the same node hierarchy.

Figure 2-4: Example of a process chain linked by input resources and output resources

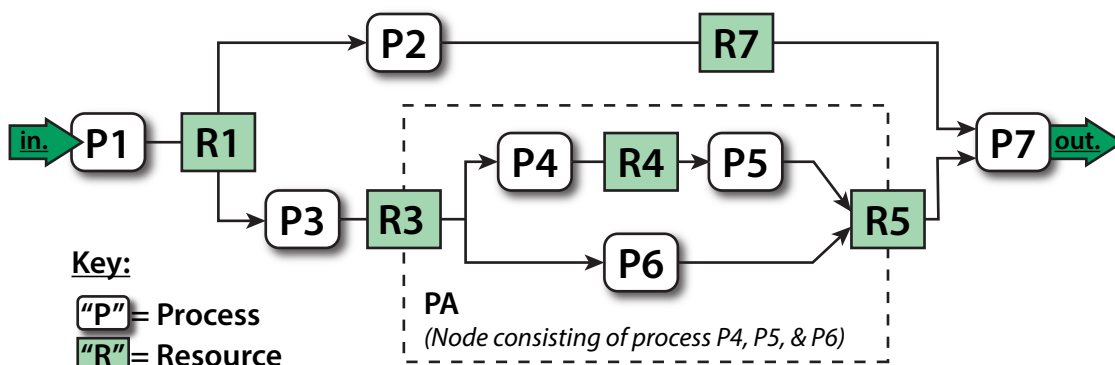

In the **JDF** specification, the linking of processes is not explicitly specified. In other words, nodes are not arranged in an abstract chronology, dictating, for example, that the trapping node is to come before the RIPing node. Rather, the links are implicitly defined in the exchange of input and output resources. Resource dependencies form a network of processes, and the sequence of process execution—that is, the routing of processes—can be derived from these dependencies. One resource dependency might have the possibility of multiple process routing scenarios. It is up to MIS to define the proper solution to meet local constraints. Note that the type of exchange resource effectively limits the processes that can be linked.

The agent or set of agents employed by MIS to write the **JDF** ▶ Job SHALL be familiar with these local constraints. They SHALL take into account factors such as the control abilities of the applications that complete the prepress processes, the transport distance between the prepress facility and the press itself, the load capabilities of the press, and the time requirements for the ▶ Job. All of the factors taken together build a process network representing the workflow of production. To aid agents in defining the workflow, **JDF** provides the following four different and fundamental types of process mechanisms, which can be combined in any way.

- 1 **Serial processing** that is subsequent production and consumption of resources as a whole, represented by a simple process chain
- 2 **Overlapping processing** that is simultaneous production and consumption of resources by pipes
- 3 **Parallel processing** that involves the splitting and sharing of resources
- 4 **Iterative processing** that is a circular or back and forward processing for developing resources by repeated activity

These mechanisms are discussed in greater detail in ▶ Section 4.3 Execution Model.

2.5 Role of Messaging in JDF

Whereas **JDF** provides a container to define a ▶ Job, the Job Messaging Format — **JMF**, defined in Chapter 5, ▶ Messaging — provides a method to generate snapshots of ▶ Job status and to interactively manipulate elements of a workflow system.

JMF is specifically designed for communication between the production system controller and the work centers or devices with which it interacts. It provides a series of queries and commands to check the status of processes and, in some cases, to dictate the next course of action. For example, the **KnownDevices** query message allows the controller to determine what processes can be executed by a particular device or work center. These processes are likely to be determined at system initialization time. The **SubmitQueueEntry** message provides a means for the controller to submit a ▶ Job ticket to individual work centers or devices. And the **Status** and **Resource** messages allow the device or work center to communicate quasi real-time¹ processing status to a controller. Depending on the system configuration, the message handler can choose to record status changes in the history logs. The status message allows the controller to request status updates from the controller.

JDF also provides mechanisms to define recipients for individual messages on a node-by-node basis. This enables controllers to define the aspects and the parts of ▶ Jobs that they want to track. For more information about messaging, see ▶ Chapter 5 Messaging.

2.6 Coordinate Systems in JDF

This chapter explains how coordinate systems are defined and used in **JDF**. It also shows how the matrices are used to specify a certain transformation and how these matrices can be used to transform coordinates from one coordinate system to another coordinate system. In addition, it clarifies the meaning of terms like "Top" or "Left".

2.6.1 Introduction

During the production of a printed product it often happens that one object is placed onto another object. During imposition, for example, single pages and marks (like cut, fold or register marks) are placed on a sheet surface. Later, at image setting, a bitmap containing one separation of a sheet surface is imposed on a piece of film. In a following step, the film is copied to a printing plate that is then mounted on a press. In postpress, the printed sheets are gathered on a pile. The objects involved in all these operations have a certain orientation and size when they are put together. In addition, one has to know *where* to place one object on the other.

The position of an object (e.g., a cut mark) on a plane can be specified by a two-dimensional coordinate. Every digital or **PhysicalResource** has its own coordinate system. The origin of each coordinate system is located in the lower left corner (i.e., the X coordinate increases from left to the right, and the Y coordinate increases from bottom to top).

1. Quasi real-time is the time-scale typically associated with production control systems. **JMF** is not intended for true real-time, lower level machine control.

Figure 2-5: Standard coordinate system

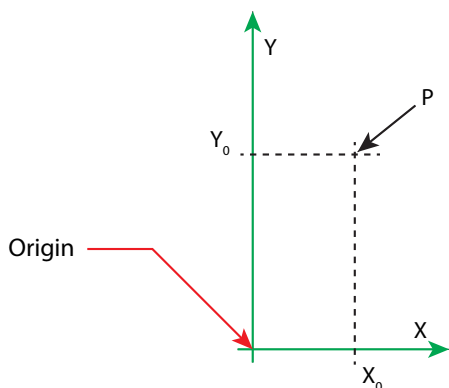

Each page contained in a PDL file has its own coordinate system. In the same way a piece of film or a sheet of paper has a coordinate system. Within **JDF** each of these coordinate systems is called a *resource coordinate system*.

If a process has more than one input resource with a coordinate system, it is necessary to define the relationship between these input coordinate systems. Therefore, a *process coordinate system* is defined for each process. **JDF** tickets are written assuming an idealized device that is defined in the process coordinate system for each process that the device implements. A real device SHALL map the idealized process coordinate system to its own device coordinate system.

The coordinate systems of the input resources are mapped to the process coordinate system. Each of those mappings is defined by a transformation matrix, which specifies how a coordinate (or position) of the input coordinate system is transformed into a coordinate of the target coordinate system. (See ▶ Section 2.6.7 Homogeneous Coordinates for mathematical background information.) In the same way, the mapping from the process coordinate system to the coordinate systems of the output resources is defined. The process coordinate system is also used to define the meaning of terms like "Top" or "Left", which are used as values for parameters in some processes.

Figure 2-6: Relation between resource and process coordinate systems

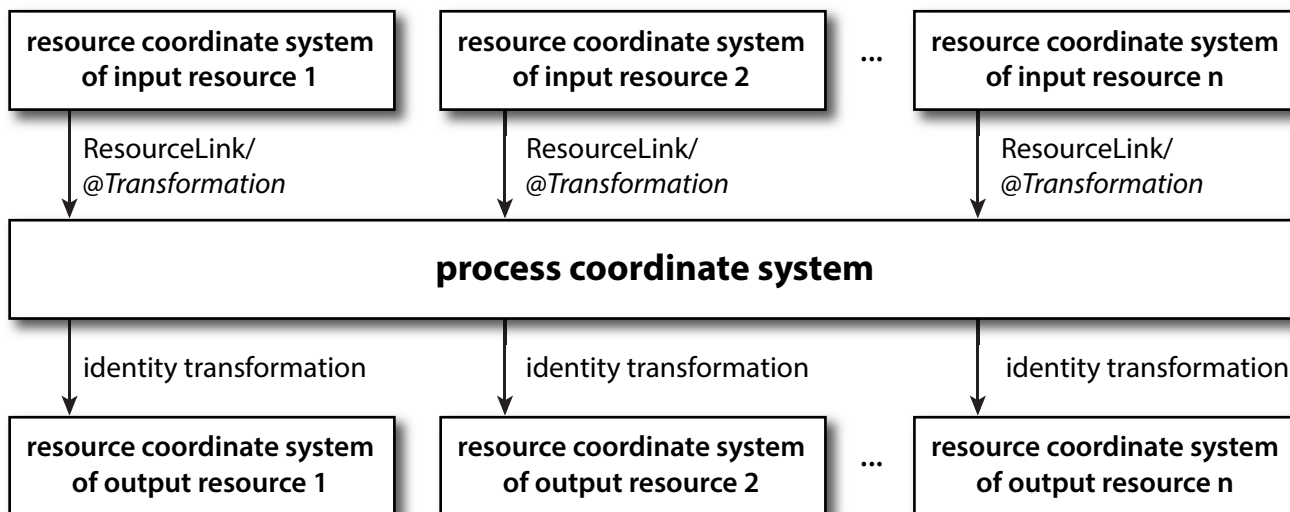

It is important that no implicit transformations (such as rotations) are assumed if the dimensions of the input resources of a process do not match each other. Instead every transformation (e.g., a rotation) SHALL be specified explicitly by using the `@Orientation` or `@Transformation` attribute of the corresponding `ResourceLink`. The same applies also to other areas in **JDF** (e.g., the `Interpreting` process). A `FitPolicy` element MAY define a policy for implied transformations.

2.6.1.1 Source Coordinate Systems

The source coordinate system of a referenced object is defined by the lower left of the object. X values are increasing to the right, Y values are increasing towards the top. In case of PDF the lower left of the `MediaBox` defines the lower left of the source coordinate system.

Note: Some object coordinate systems have optional tags to indicate internal transformations. These internal transformations SHALL be applied prior to defining the source coordinate system; for instance:

OVERVIEW

- PDF: the rotation defined by the Rotate key SHALL be applied. The lower left of the MediaBox of the rotated PDF defines the lower left of the PDF source coordinate system.
- TIFF: the orientation defined by the Orientation tag SHALL be applied. The lower left of the rotated TIFF defines the lower left of the TIFF source coordinate system.

2.6.2 Coordinates and Transformations

Table 2.3: Data types for specifying coordinates and transformation

DATA TYPE	EXAMPLE
XYPair	"612 792"
double	"20.7"
rectangle	"0 0 595 843" (Order of elements is "lower-left x, lower-left y, upper-right x, upper-right y" or "left, bottom, right, top".)
Matrix	"1 0 0 1 30.0 235.3" The ordering of elements is defined in ▶ Section 2.6.7 Homogeneous Coordinates.
Orientation	"Rotate180" or "Flip90"

Coordinates and transformations are used throughout **JDF**, to include:

Intent Resources, such as:

- **LayoutIntent**: specifies size of finished product
- **MediaIntent**: specifies size of media
- **InsertingIntent**: specifies rotation and offset of inserts

Process Resources, such as:

- **Component**: specifies coordinate system
- **CutBlock**: specifies cut block coordinate system
- **FoldingParams**: specifies folding operations

2.6.3 Coordinate Systems of Resources and Processes

Each physical input resource (e.g., **Component**) of a process has, by default, its own coordinate system, which is called the *resource coordinate system*. The coordinate system also implies a specific orientation of that **Resource**. On the other hand there is a coordinate system that is used to define various process-specific parameters. This coordinate system is called a target or process coordinate system.

It is often necessary to change the orientation of an input resource before executing the operation. This can be done by specifying a transformation matrix. It is stored in the **@Orientation** or **@Transformation** attribute of the **ResourceLink**. This provides the ability to specify different matrices for the individual resources of a process. For details on **ResourceLink** elements, see ▶ Section 3.9 ResourceLinkPool and ResourceLink.

2.6.3.1 Use of Preview to Display Resource Orientation

It is often necessary to load printed material into finishing equipment manually. Particularly in the case of imposed sheets, the page orientation will not be unique and even the concept of "Front" or "Back" can be confusing, since front and back pages can be printed on the same surface of the imposed sheet. **Preview** resources with **Preview/@PreviewUsage = "Thumbnail"** or **Preview/@PreviewUsage = "Viewable"** SHOULD be provided to illustrate the desired orientation of the input components with respect to the device.

2.6.3.2 Coordinate Systems of Combined Processes

New in JDF 1.2

Combined Processes (see ▶ Section 3.3.3 Combined Process Nodes) combine multiple individual processes and thus also the respective coordinate systems of those processes. The process coordinate systems are not modified by the fact that the processes are part of a combined process, they are identical to the process coordinate systems of the processes, were they defined in a linked chain of individual processes. The coordinate systems of an exchange resource can be modified by defining it as a pipe by specifying **Resource/@PipeID** and **Resource/@PipeProtocol = "Internal"** (See ▶ Section 4.3.3 Overlapping processing Using Pipes) and linking it to the combined process with both an input and output **ResourceLink**. The input **ResourceLink** defines the coordinate transformation using the standard **@Transformation** or **@Orientation** attributes. **Resource/@Status** of the exchange resource SHALL be **"Complete"**.

2.6.4 Coordinate System Transformations

The following table shows some matrices that can be used to change the orientation of a [PhysicalResource](#). Most of the transformations require the width (**w**) and the height (**h**) of the [Component](#) as specified by X and Y in [Component/@Dimensions](#). If these are unknown, it is still possible to define a general orientation in [ResourceLink/@Orientation](#). The naming of the attribute reflects the state of the resource and not necessarily the order of applied transformations. Thus "Rotate90" and "Flip90" specify that the original Y axis as represented by the spine is on top. In the case of Flip90, the [Component](#) is additionally flipped front to back.

Table 2.4: Matrices and Orientation values for describing the orientation of a Component (Sheet 1 of 2)



ORIENTATION VALUE	SOURCE COORDINATE SYSTEM	TRANSFORMATION MATRIX ACCORDING ACTION	TARGET COORDINATE SYSTEM
Rotate0		$1 \ 0 \ 0 \ 1 \ 0 \ 0$ No Action	
Rotate90		$0 \ 1 \ -1 \ 0 \ h \ 0$ 90° Counterclockwise Rotation	
Rotate180		$-1 \ 0 \ 0 \ -1 \ w \ h$ 180° Rotation	
Rotate270		$0 \ -1 \ 1 \ 0 \ 0 \ w$ 270° Counterclockwise Rotation	
Flip0		$1 \ 0 \ 0 \ -1 \ 0 \ h$ Flip around X	
Flip90		$0 \ -1 \ -1 \ 0 \ h \ w$ 90° Counterclockwise Rotation + Flip around X	
Flip180		$-1 \ 0 \ 0 \ 1 \ w \ 0$ 180° Rotation + Flip around X	

Table 2.4: Matrices and Orientation values for describing the orientation of a Component (Sheet 2 of 2)

ORIENTATION VALUE	SOURCE COORDINATE SYSTEM	TRANSFORMATION MATRIX ACCORDING ACTION	TARGET COORDINATE SYSTEM
Flip270		$ \begin{matrix} 0 & 1 & 1 & 0 & 0 & 0 \\ \end{matrix} $ 270° Counterclockwise Rotation + Flip around X	

2.6.5 Product Example: Simple Brochure

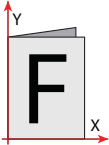
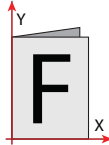
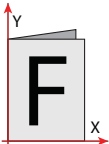
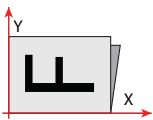
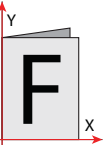
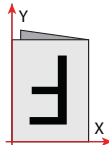
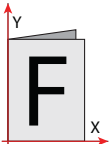
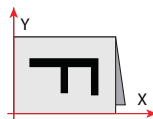
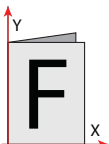
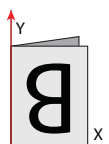
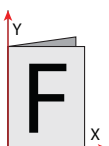
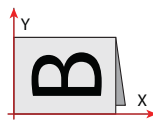
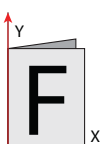
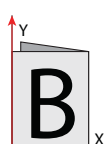
To illustrate the use of coordinate systems in **JDF**, a simple saddle stitched brochure with eight pages is used as an example in ▶ Table 2.5 JDF Processes used for the production of the simple brochure. The brochure is printed on two sheets with front and back. The two sheets are then folded, collected on a saddle, and saddle stitched. Finally the brochure is cut with a three-side trimmer.

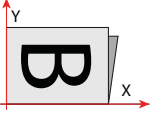
Table 2.5: JDF Processes used for the production of the simple brochure

INPUT RESOURCES	PROCESS	OUTPUT RESOURCES
Layout RunList (Document) RunList (Marks)	Imposition	RunList
RunList	Interpreting	RunList (of interpreted PDL data)
RunList (of interpreted PDL data) Media RenderingParams	Rendering	RunList (of rasterized byte maps)
RunList (of rasterized byte maps)	Screening	RunList (of bit maps)
ImageSetterParams Media (of film) RunList (of bit maps)	ImageSetting (to film)	ExposedMedia (of film)
ExposedMedia (of film)	ContactCopying	ExposedMedia (of plate)
ExposedMedia (of plate) ConventionalPrintingParams	Conventional Printing	Component
FoldingParams Component	Folding	Component
CollectingParams Component	Collecting	Component
StitchingParams Component	Stitching	Component
TrimmingParams Component	Trimming	Component

At imposition, the layout describes a signature with two sheets, each having a front and a back surface. On each surface, two content objects (i.e., pages, are placed).

Figure 2-7: Layout of simple saddle stitched brochure (product example)

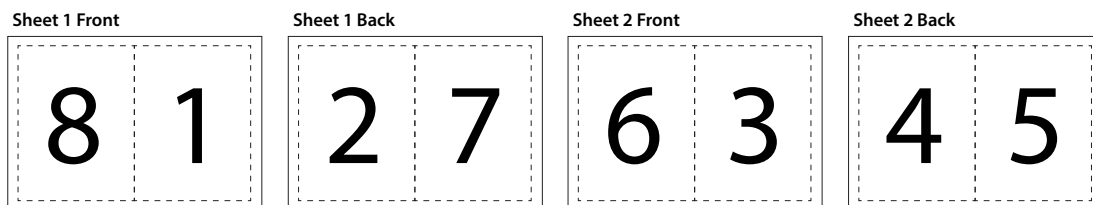

Each surface has its own coordinate system, in which a surface contents box is defined. This coordinate system is also referred to as the **Layout** coordinate system because the signature, sheet and surface elements are defined within the hierarchy of the **Layout** resource by means of partitioning. The content objects are placed by specifying the CTM attribute relative to the surface contents box. If the position of an object within a page is given in the page coordinate system, this coordinate can be transformed into a position within the surface coordinate system:

Figure 2-8: Equation for surface coordinate system transformations

$$P_{Surface} = P_{Page} \times CTM_{Page} + [SurfaceContentsBox_{x_{lowerleft}} \quad SurfaceContentsBox_{y_{lowerleft}} \quad 0]$$

Please note, that the width and height of the surface NEED NOT be known at this point.

Figure 2-9: Surface coordinate system

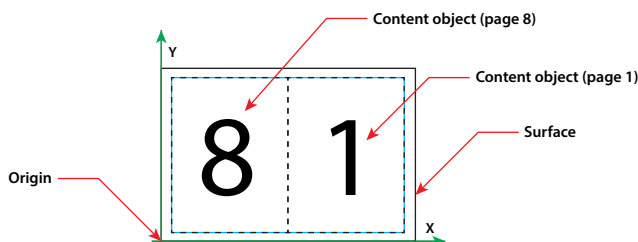

The sheet coordinate system is identical with the coordinate system of the front surface. This means that no transformation is needed to convert a coordinate from one system to the other. Instead, the coordinates are valid (and equal) in both coordinate systems. The relation between the coordinate system of the front and the back surfaces depends on the value of the **Layout/@LockOrigins** attribute. The sheet coordinate system is also identical with the signature coordinate system, which in turn is identical with the coordinate system of the **Imposition** process.

The output resource of the **Imposition** process is a run list. Each element of the run list has its own coordinate system, which is identical with the corresponding signature coordinate system. The interpretation, rendering and screening processes do not affect the coordinate systems. This means that the coordinate systems of all these processes are identical.

At the **ImageSetting** process, the digital data is set onto film. The process coordinate system is defined by the **Media** input resource. The width and height of the media are defined in the **Media/@Dimension** attribute. The position of the signatures (as defined by the **RunList** input resource) on the film is defined by the **ImageSetterParams/@CenterAcross** attribute.

The coordinate system of the conventional and digital printing processes is called *press coordinate system*. It is defined by the press: the X-axis is parallel to the press cylinder, and the Y-axis is going along the paper travel. Y = 0 is at begin of print, X = 0 is at the left edge of the maximum print area. The front side of the press sheet faces up towards the positive Z-axis. The relationship between the layout coordinate system and the press coordinate system is defined by the **@CTM** attributes of the corresponding **TransferCurveSet** elements located in the **TransferCurvePool**.

Figure 2-10: Press coordinate system used for sheet-fed printing

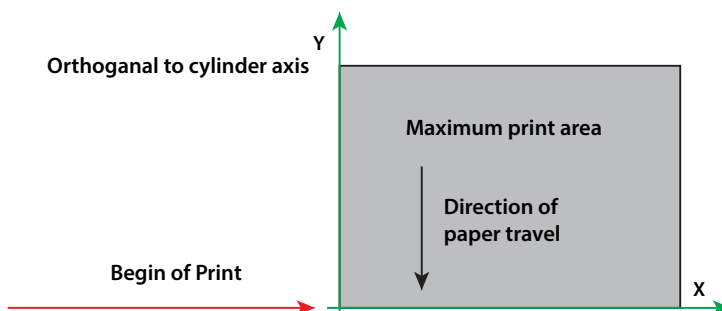
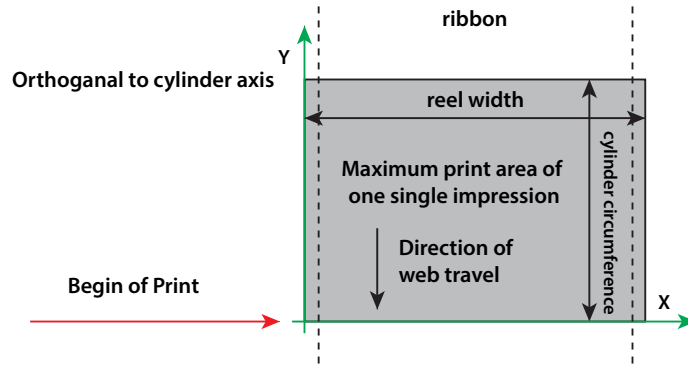

Figure 2-11: Press coordinate system used for web printing



The output of the printing process (e.g., a pile of printed sheets) is described as a **Component** resource in **JDF**. The coordinate system of the printed sheets is defined by the transformation given in the **TransferCurveSet/@CTM** attribute (where **@Name** = "Paper").

Each of the two sheets is folded in a separate **Folding** process. In this example, the orientation of the sheets is not changed before folding. This can be specified by setting the **@Orientation** attribute of the **Component** input resource to "Rotate0" or by setting the **@Transformation** attribute to "1 0 0 1 0 0". The **Folding** process changes the coordinate system. In this example the origin of the coordinate system is moved from the lower left corner of the flat sheet (input) to the lower left corner of the folded sheet (output) (i.e., it is moved to the right by half of the sheet width).

Figure 2-12: Coordinate systems after Folding (product example)

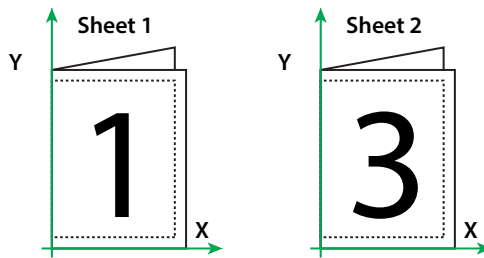

The two folded sheets are now collected. In this example, the orientation of the folded sheets is not changed before collecting. This can be specified by setting the **@Orientation** attribute of the **Component** input resource to "Rotate0" or by setting the **@Transformation** attribute to "1 0 0 1 0 0". The **Collecting** process does not change the coordinate system.

Figure 2-13: Coordinate systems after Collecting (product example)

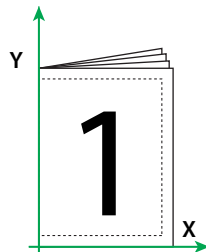

The two collected and folded sheets are now trimmed to the final size of the simple brochure. In this example, the orientation of the collected and folded sheets is not changed before trimming. This can be specified by setting the **@Orientation** attribute of the **Component** input resource to "Rotate0" or by setting the **@Transformation** attribute to "1 0 0 1 0 0". The **Trimming** process changes the coordinate system: the origin is moved to the lower left corner of the trimmed product.

In looking at the whole production process, a series of coordinate systems is being involved. The relationship between the separate coordinate systems is specified by transformation matrices. This allows transformation of a coordinate from one coordinate system to another coordinate system. As an example, note the position of the title on page 1 of the

product example in ▶ Figure 2-13: Coordinate systems after Collecting (product example). By applying the first transformation, this position can be converted into a position of the surface (or layout) coordinate system. This position can then be converted into the paper coordinate system by applying (in this order) the "Film", "Plate", "Press" and "Paper" transformations stored in the **TransferCurvePool**.

From now on in the workflow, every process is using one or more **Component** resources as input and output resources. The **ResourceLink** of each input and output **Component** contains a **@Transformation** attribute or an **@Orientation** attribute. The **@Transformation** attribute SHALL be used if the width and the height of the **Component** are known or a non-orthogonal rotation is needed. Otherwise the **@Orientation** attribute SHOULD be used to specify a change of the orientation (e.g., an orthogonal rotation).

Since the **Folding** process changes the coordinate system depending on the fold type, the transformations specified in the **ResourceLink** elements are not sufficient to transform a position given in the paper coordinate system to a position in the coordinate system of the folded sheets (i.e., the *resource coordinate system* of the output component of the **Folding** process). An additional transformation depending on the fold type and details of the individual folds has to be applied. The corresponding transformation matrix is not explicitly specified in the **JDF** file.

The **Collecting** process does not change the coordinate system. Therefore, only the transformations specified in the **ResourceLink** elements of the **Component** input and output resources (i.e., components have to be applied).

The **Trimming** process again changes the coordinate system depending on the trimming parameters. Therefore, a transformation depending on the trimming parameters has to be applied in addition to the transformations specified in the **ResourceLink** elements. The matrix for the additional transformation (depending on the trimming parameters) is not explicitly specified in the **JDF** file.

After having applied all transformations mentioned above, the resulting coordinate specifies the position of the title in the coordinate system of the final product.

Figure 2-14: Examples of transformations and coordinate systems in JDF.

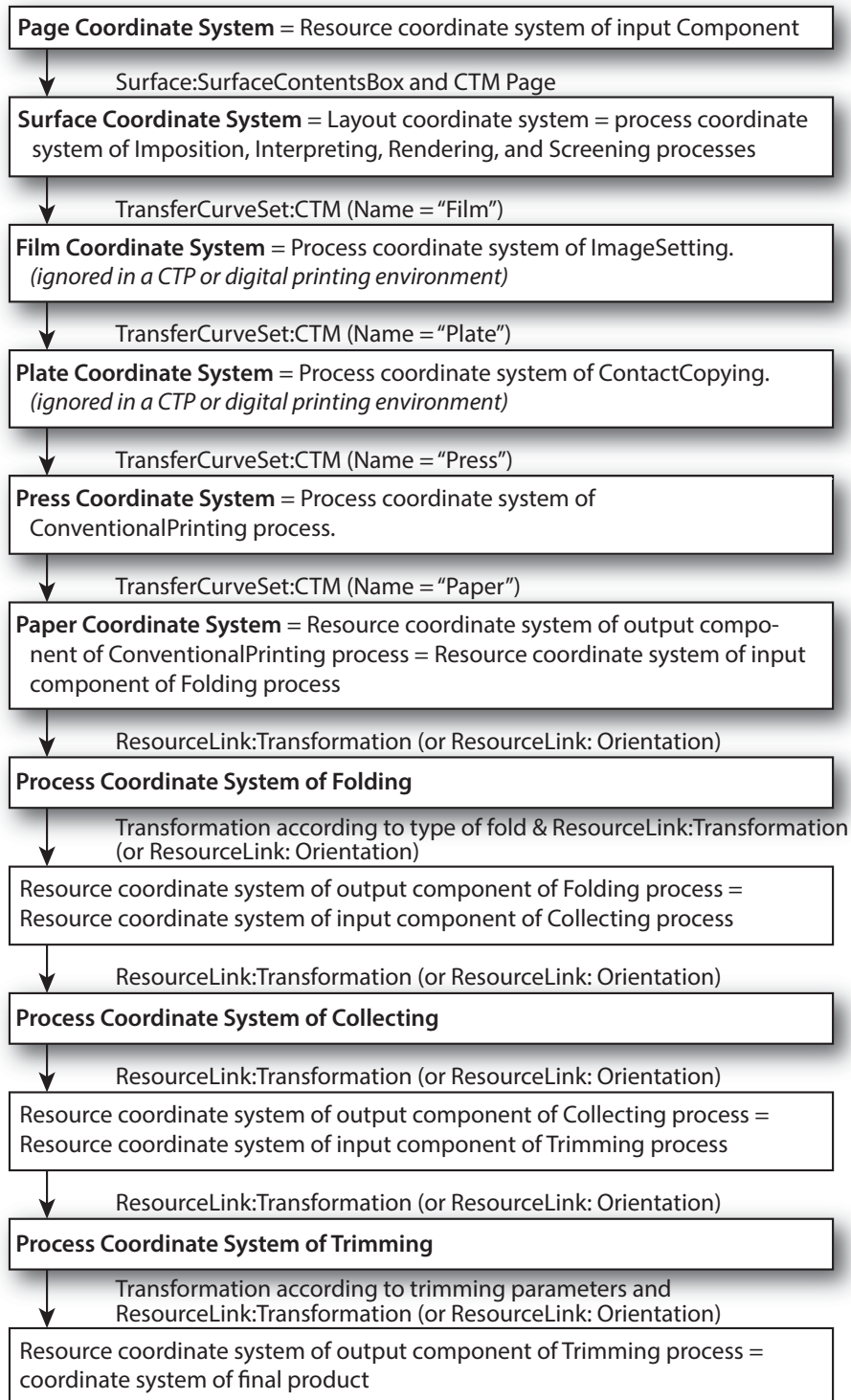

2.6.6 General Rules

The following rules summarize the use of coordinate systems in **JDF**.

- Every individual piece of material (film, plate, paper) has a *resource coordinate system*.
- Every process has a *process coordinate system*.
- Terms like *top*, *left*, etc., are used with respect to the *process coordinate system* in which they are used and are independent of orientation (i.e., *landscape* or *portrait*), and the human reading direction.
- The coordinate system of each input component is mapped to the process coordinate system.
- The coordinate system might change during processing (e.g., in **Folding**).
- The description of a product in **JDF** is independent of the particular ▶ Machine used to produce this product. When creating setup information for an individual ▶ Machine, it might be necessary to compensate for certain

► Machine characteristics. At printing, for example, it might be necessary to rotate a landscape job because the printing width of the press is not large enough to run the job without rotation.

2.6.7 Homogeneous Coordinates

A convenient way to calculate coordinate transformations in a two-dimensional space is by using so-called homogeneous coordinates. With this concept, a two-dimensional coordinate $P=(x,y)$ is expressed in vector form as $[x\ y\ 1]$. The third element "1" is added to allow the vector being multiplied with a transformation matrix describing scaling, rotation, and translation in one shot. Although this only requires a 2*3 matrix (e.g., as it is used in PostScript) in practice 3*3 matrices are much more common, because they can be concatenated very easily. Thus, the third column SHALL be set to "0 0 1".

Table 2.6: Coordinate Transformation Examples

MATRIX	JDF VALUE	DESCRIPTION
$\begin{bmatrix} a & b & 0 \\ c & d & 0 \\ e & f & 1 \end{bmatrix}$	"a b c d e f"	General transformation case.
$\begin{bmatrix} 1 & 0 & 0 \\ 0 & 1 & 0 \\ 0 & 0 & 1 \end{bmatrix}$	"1 0 0 1 0 0"	Identity transformation.
$\begin{bmatrix} 1 & 0 & 0 \\ 0 & 1 & 0 \\ dx & dy & 1 \end{bmatrix}$	"1 0 0 1 dx dy"	Translation by dx, dy.
$\begin{bmatrix} \cos\phi & \sin\phi & 0 \\ -\sin\phi & \cos\phi & 0 \\ 0 & 0 & 1 \end{bmatrix}$	"cosφ sinφ -sinφ cosφ 0 0"	Rotation by φ degrees counter-clockwise.

2.6.7.1 Transforming a point

In this example, the position P given in the coordinate system A is transformed to a position of coordinate system B. The relationship between the two coordinate systems is given by the transformation matrix Trf .

Figure 2-15: Transforming a point (example)

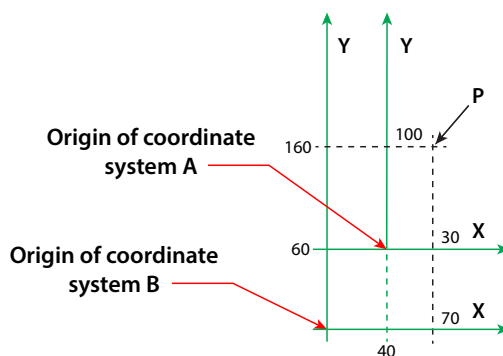

Transformation sequence

$$P_A = [30\ 100\ 1]$$

Starting position
 $P_A = (30, 100)$

$$P_B = P_A \times Trf$$

Transformation

$$P_B = [30\ 100\ 1] \times \begin{bmatrix} 1 & 0 & 0 \\ 0 & 1 & 0 \\ 40 & 60 & 1 \end{bmatrix}$$

Expanded translation transformation. In JDF, Trf is written as an attribute with a data type of matrix, e.g. @CTM="1 0 0 1 40 60"

$$P_B = [70 \ 160 \ 1]$$

Result position
 $P_B = (70, 160)$

3 Structure

This chapter describes the structure of **JDF** nodes and how they interrelate to form a job. As described in ▶ Section 2.2.1 Job Components, a node is a construct, encoded as an XML element, that describes a particular part of a **JDF** job. Each node represents an aspect of the job in terms of:

- 4 A process necessary to produce the end result, such as imposing, printing or binding;
- 5 A product that contributes to the end result, such as a brochure; or
- 6 Some combination of the previous two.

In short, a node describes a product intent or a process step.

In addition to describing the structure of an individual **JDF** node, this chapter examines in what way those nodes interact to form a coherent job structure. The visual correlative of this structure resembles a family tree with a single node describing the entire job at the top, and a number of nodes at the bottom that each describes only one specific process. **JDF** supported, leaf-level processes are described in ▶ Chapter 6 Processes.

Resource linking specifies the transformation of input resources into output resources, which in turn might become inputs of other nodes. It also allows nodes to share the same resource. The combination of hierarchical nesting of nodes and resource linking allows complex process networks to be constructed. In a simple case, however, a **JDF** instance MAY contain only one node. The only way that a **JDF** node can identify its input and output resources is by using **ResourceLink** elements.

The hierarchical structure of a **JDF** job achieves a functional grouping of processes. For example, a job might be split into a prepress node, a press node and a finishing node that contain the respective process nodes. Each and every node in turn contains attributes that represent various characteristics of that node. Nodes also contain subelements of certain types, such as resources, process information, customer information, audits, logging information and other **JDF** nodes. Some elements, such as those that deal with customer information, typically occur in the root structure, while other elements, such as resources, MAY occur anywhere in the tree. Where the elements can reside depends on their type and their usage scope.

This chapter describes the elements, subelements and attributes commonly found in **JDF** nodes, and provides the characteristics necessary to understand where each belongs and how it is used. Many of these characteristics are presented in tables, and each of these tables includes the following three columns.

- **Name** — Identifies the element being discussed.
- **Data Type** — Refers to the data type, all of which are described in ▶ Section 1.6 Data Structures. Only the data types **element** and **text** are applied to elements. All other types are attributes.
- **Description** — Provides detail about the element or attribute being discussed.

The **JDF** workflow model is based on a resource/consumer model. **JDF** nodes are the consumers that are linked by input resources and output resources. The ordering of siblings within a node, however, has no effect on the execution of a node. All chronological and logical dependencies are specified using **ResourceLink Resource** elements, which are defined in ▶ Section 3.9 ResourceLinkPool and ResourceLink ▶ Section 3.8.2 Resource.

3.1 Generic Contents of All Elements

JDF contains a set of generic structures that MAY occur in any element of a **JDF** or **JMF** document. Some of these are provided as containers for human-readable comments and descriptions and are described below. Others define the usage policy for attributes and subelements.

Table 3.1: Any Element (generic content) (Sheet 1 of 2)

NAME	DATA TYPE	DESCRIPTION
<i>BestEffortExceptions</i> ? New in JDF 1.1	NMTOKENS	The names of the attributes in this element that are to have the best effort policy applied when <i>@SettingsPolicy</i> is not "BestEffort".
<i>CommentURL</i> ?	URL	URL to an external, human-readable description of the element. Note that <i>@CommentURL</i> MAY be specified within a <i>Comment</i> .

Table 3.1: Any Element (generic content) (Sheet 2 of 2)

NAME	DATA TYPE	DESCRIPTION
<i>DescriptiveName</i> ?	string	Human-readable descriptive name of the JDF element (e.g., a descriptive name of a resource, process or product intent). It is strongly RECOMMENDED to supply <i>@DescriptiveName</i> in all JDF nodes, Quantity Resources (for example: Component resources) and Handling Resources (for example, ExposedMedia) for communication from applications to humans in order to reference the process or resource.
<i>MustHonorExceptions</i> ? New in JDF 1.1	NMTOKENS	The names of the attributes in this element that are to have the "MustHonor" policy applied when <i>@SettingsPolicy</i> is not "MustHonor".
<i>OperatorInterventionExceptions</i> ? New in JDF 1.1	NMTOKENS	The names of the attributes in this element that are to have the operator intervention policy applied when <i>@SettingsPolicy</i> is not "OperatorIntervention". If a device has no operator intervention capabilities, <i>@OperatorIntervention</i> is treated as "MustHonor".
<i>SettingsPolicy</i> ? New in JDF 1.2	enumeration	The policy for this element indicates what happens when unsupported settings (i.e., subelements, attributes or attribute values) are present in the element. Default value is from: parent's <i>@SettingsPolicy</i> . If not specified in the parent element or further superior elements, the default value is "BestEffort". Allowed values are: BestEffort – Substitute or ignore unsupported attributes, attribute values, default attribute values or elements, and continue processing the job. MustHonor – Reject the job when any unsupported attributes, attribute values or elements are present. OperatorIntervention – Pause job and query the operator when any unsupported attributes, attribute values or elements are present. If a device has no operator intervention capabilities, "OperatorIntervention" is treated as "MustHonor". Note: For additional details on <i>@SettingsPolicy</i> , see ▶ Section 1.5.3 Conformance to Settings Policy.
<i>Comment</i> *	element	Any human-readable text. The Comment element is different from an XML comment <code><!-- XML Comment --></code> . The JDF Comment is meant for display in a user interface whereas the XML comment is used to add developers comments to the underlying XML. Comments SHALL NOT be nested within Comment elements.
<i>GeneralID</i> * New in JDF 1.4	element	Additional identifiers related to the element. Creation note: Starting with JDF 1.4 , GeneralID has been promoted from being only in a resource to being in any JDF element.
<i>Preview</i> * New in JDF 1.4	refelement	Provides a Preview resource for thumbnails or other images. The element SHALL NOT contain multiple Preview resources with the same Preview/@PreviewUsage values. Creation note: Starting with JDF 1.4 , Preview has been moved from ▶ Table 6.1 Template for Input Resources.

3.1.1 Structure Diagram

▶ Figure 3-1: Any element (generic content) – a diagram of its structure below shows the structure of the generic content defined above. ▶ Figure 3-1: Any element (generic content) – a diagram of its structure and other similar diagrams describe **JDF** structure using the following notation.

- Each box represents an element, with the element's name in the rounded box at the top and its attributes, if any, listed below. A rounded box with a dashed line represents an abstract element.
- A solid line connects an element to its subelement, with the arrowhead directed towards the subelement. The cardinality of the subelement is specified after its name. Cardinality in the line overrides that in the box.
- A dashed line connects an element to its abstract element, where the superclass element is at the arrowhead.

Figure 3-1: Any element (generic content) – a diagram of its structure

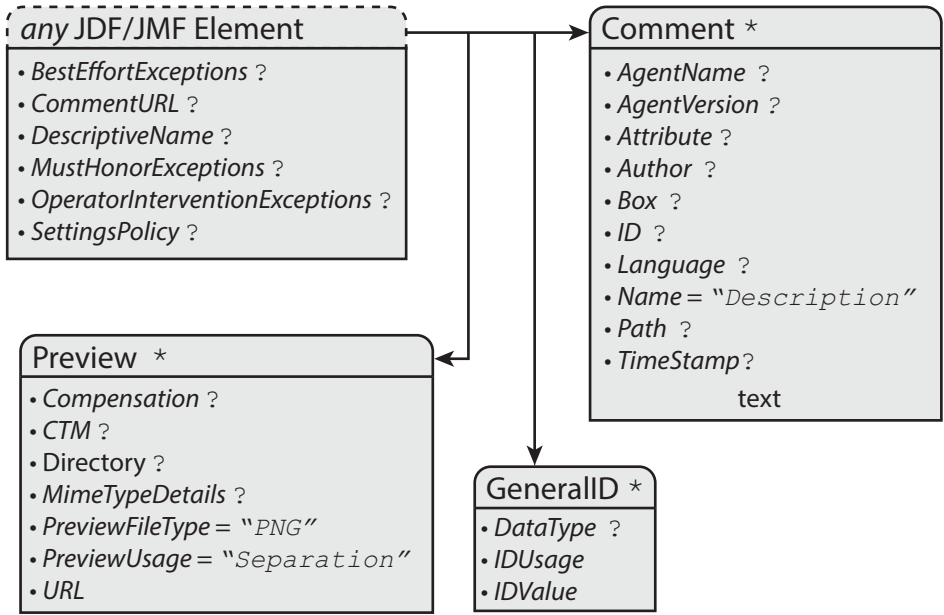

3.2 JDF

The top-level element of a **JDF** instance is a **JDF** element. **JDF** elements MAY also be nested within other **JDF** elements. The individual **JDF** elements are referred to as “nodes” and nodes, in turn, contain various attributes and further sub-elements, including nested **JDF** nodes.

The following table presents the attributes and elements likely to be found in any given **JDF** node. Three of the attributes in ▶Table 3.4 JDF, below, SHALL appear in every **JDF** node. Although the rest are designated as OPTIONAL, some OPTIONAL attributes become REQUIRED under circumstances described in the Description column.

The most important of the attributes is the @Type attribute, which defines the node type. The value of the @Type attribute defines the product intent or process the **JDF** node represents. As is detailed in ▶Section 3.3 Common Node Types, all nodes fall into one of the following four general categories: Process, Process Group, Combined Processes and Product Intent. Each node is identified as belonging to one of these categories by the value of its @Type attribute, as described in the table below. For example, if @Type = "Product", the node is a product intent node. Each of these categories is described in greater detail in the sections that follow.

Each attribute/element in ▶Table 3.4 JDF has a scope. The scope provides further details about the valid range of the attribute/element content, how the content is inherited by descendants (children, grandchildren, etc.), and where the attribute/element can reside in the **JDF** tree.

The scope is specified by the first line of each Description cell in ▶Table 3.4 JDF. The first line is always: “Scope and Position is XXX” where the meaning of XXX is defined in ▶Table 3.2 Definition of Scope and Position.

Table 3.2: Definition of Scope and Position

XXX	DESCRIPTION
Descendent	The content is valid locally within its node and in all descendent nodes, unless a descendent contains an identical attribute that overrides the content.
Local	The content is only valid locally, within the node where the content is defined.
Root	The attribute SHALL be specified only in the root node. An exception from the localization only in the root node occurs if the spawning and merging mechanism for independent job tickets is applied as described in ▶Section 4.4 Spawning and Merging. All attributes and elements listed in subsequent chapters SHOULD be considered local unless otherwise noted.

Table 3.3: Behavior for Activation Enumeration Values

ACTIVATION	TEST NODE	EXECUTE NODE
Inactive	false	false
Informative	false	false
Held	false	false
Active	false	true
TestRun	true	false
TestRunAndGo	true	true

Table 3.4: JDF (Sheet 1 of 4)

NAME	DATA TYPE	DESCRIPTION
<i>Activation</i> ? Modified in JDF 1.1	enumeration	<p>Scope and Position is Descendent.</p> <p>Describes the activation status of the JDF node. Allows for a range of activity, including deactivation and test running.</p> <p>A child node inherits the value of the <i>@Activation</i> attribute from its parent. The value of <i>@Activation</i> corresponds to the least active value of <i>@Activation</i> of any ancestor, including itself. Therefore, if any ancestor has an <i>@Activation</i> of "Inactive", the node itself is "Inactive".</p> <p>If no ancestor is "Inactive" but any ancestor is "Informative", the node is "Informative" unless the node itself is "Inactive". If no ancestor is "Informative" but any ancestor is "TestRun", the node is "TestRun" unless the node itself is "Informative". If no ancestor has a value of "Inactive" or "TestRun" and any ancestor has a value of "TestRunAndGo", the node has a value of "TestRunAndGo" unless that node is "Inactive" or "TestRun" and so on. ▶ Table 3.3 Behavior for Activation Enumeration Values illustrates the actions to be applied to a node depending on the value of <i>@Activation</i>.</p> <p>The values are ordered from least to most active</p> <p>Allowed value is from: ▶ Activation.</p>
<i>Category</i> ? New in JDF 1.2 Modified in JDF 1.4	NMTOKEN	<p>Scope and Position is Local.</p> <p>Named category of this node. Used when <i>@Type</i> = "Combined" or <i>@Type</i> = "ProcessGroup" to identify the general node category. This allows processors to identify the general purpose of a node without parsing the <i>@Types</i> field. For instance, a RIP for final output and a RIP for proof process have identical <i>@Types</i> attribute values, but have <i>@Category</i> = "ProofRIPing" or <i>@Category</i> = "RIPing", respectively.</p> <p>Values include those from: ▶ Node Categories.</p> <p>Note: <i>@Category</i> MAY also be the name of a gray box defined by an ICS document.</p>
<i>ICSVersions</i> ? New in JDF 1.2	NMTOKENS	<p>Scope and Position is Descendent.</p> <p><i>@ICSVersions</i> SHALL list all CIP4 Interoperability Conformance Specification (ICS) Versions that this JDF node complies with. The value of <i>@ICSVersions</i> SHALL conform to the value format described in ▶ Section 3.2.1 ICS Versions Value.</p>
<i>ID</i>	ID	<p>Scope and Position is Local.</p> <p>Unique identifier of a JDF node. This ID is used to refer to the JDF node.</p>
<i>JobID</i> ?	string	<p>Scope and Position is Descendent.</p> <p>Job identification used by the application that created the JDF job. Typically, a job is identified by the internal order number of the MIS system that created the job.</p>

Table 3.4: JDF (Sheet 2 of 4)

NAME	DATA TYPE	DESCRIPTION
JobPartID ? New in JDF 1.2	string	Scope and Position is Descendent. Identification of a JDF node within a job, used by the application that created the job. Typically, @JobPartID is internal to the MIS system that created the job and specifies a process or set of processes. Note that a product that is produced by a process or set of processes is identified by Resource/@ProductID and not by @JobPartID .
MaxVersion ? New in JDF 1.2	enumeration	Scope and Position is Descendent. Maximum JDF version to be written by an agent that modifies this node. If not specified, an agent that processes the node MAY write any version it is capable of writing. See ▶ Section 3.13 JDF Versioning for a discussion of versioning in JDF . Allowed value is from: ▶ JDFJMFVersion.
NamedFeatures ? New in JDF 1.2 Deprecated in JDF 1.5	NMTOKENS	Scope and Position is Local. @NamedFeatures represents an implementation dependent set of parameters for setting up a device that a device SHALL apply to the JDF ticket. It is formatted as an ordered list of name value pairs with an even number of entries. The @NamedFeatures names supported by the device MAY be specified in DeviceCap elements. See ▶ Section 10.2.1 DeviceCap. @NamedFeatures SHALL be placed only in combined nodes, process group nodes or product intent nodes. For process group nodes, the @Types attribute is typically supplied. See ▶ Section 3.3.2.2 Use of NamedFeature in Product and Process Group Nodes for details. Deprecation note: Starting with JDF 1.5, use JDF/GeneralID[@DateType="NamedFeature"] .
ProjectID ? New in JDF 1.1	string	Scope and Position is Descendent. Identification of the project context that this JDF belongs to. @ProjectID SHOULD be used by a controller to group a set of JDF jobs.
RelatedJobID ? New in JDF 1.2	string	Scope and Position is Descendent. Job identification of a related job. Used to identify the @JobID of a previous run of this job or job with very similar settings. It MAY be used to retrieve additional job and device specific settings from a data store.
RelatedJobPartID ? New in JDF 1.2	string	Scope and Position is Descendent. Job identification of a related job part. Used to identify the @JobPartID of a previous run of this job or job with very similar settings. It MAY be used to retrieve additional job and device specific settings from a data store.
RelatedProjectID ? New in JDF 1.6	string	Scope and Position is Descendent. Identification of a related project context that this JDF belongs to. @RelatedProjectID SHOULD be used by a controller to group a set of JDF jobs.
SpawnID ? New in JDF 1.1	NMTOKEN	Scope and Position is Descendent. Identification of a spawned part of a job. Typically this is used to map Audit elements and JMF messages to a spawned processing step in the workflow. For details on job spawning, see ▶ Section 4.4 Spawning and Merging.
Status Modified in JDF 1.3	enumeration	Scope and Position is Local. Identifies the status of the node. Derivation of the @Status of a parent node from the @Status of child nodes is non-trivial and implementation-dependent. Allowed value is from: ▶ Status.
StatusDetails ? New in JDF 1.2	string	Scope and Position is Local. Description of the status phase that provides details beyond the enumerative values given by the @Status attribute. Values include those from: ▶ Status Details.

Table 3.4: JDF (Sheet 3 of 4)

NAME	DATA TYPE	DESCRIPTION
<i>Template</i> = "false" New in JDF 1.1	boolean	Scope and Position is Root. Indicates that this JDF node (or instance) is a template that is used to generate JDF elements but SHALL NOT be exchanged as a job definition. A device SHALL reject a job ticket that contains <i>@Template</i> = "true".
<i>TemplateID</i> ? New in JDF 1.2	string	Scope and Position is Descendent. Name or ID that identifies a JDF template. Can be used to differentiate between various templates. If <i>@Template</i> = "false", <i>@TemplateID</i> identifies the template that was used to generate this JDF .
<i>TemplateVersion</i> ? New in JDF 1.2	string	Scope and Position is Descendent. Provides the version of the JDF template. Can be used to differentiate between various template versions. If <i>@Template</i> = "false", <i>@TemplateVersion</i> identifies the version of the template that was used to generate this JDF .
<i>Type</i>	NMTOKEN	Scope and Position is Local. Identifies the type of the node. Any JDF process name is a valid type. The processes that have been predefined are listed in ▶ Chapter 6 Processes, although the flexibility of JDF allows anyone to create processes. In addition to these, there are three values which are described in greater detail in the sections that follow. Values include: <i>Combined</i> <i>ProcessGroup</i> <i>Product</i> – Identifies a product intent node. Values include those from: ▶ Chapter 6 Processes.
<i>Types</i> ? Modified in JDF 1.2	NMTOKENS	Scope and Position is Local. List of the <i>@Type</i> attributes of the nodes that are combined to create this node. This attribute is REQUIRED if <i>@Type</i> = " <i>Combined</i> ", OPTIONAL when <i>@Type</i> = " <i>ProcessGroup</i> ", and is ignored if <i>@Type</i> equals any other value. For details on using combined process nodes, see ▶ Section 3.3.3 Combined Process Nodes. If the <i>@Types</i> attribute is specified, that JDF node SHALL NOT contain child JDF nodes. For details on using process group nodes, see ▶ Section 3.3.2 Process Group Nodes. If <i>@Type</i> = " <i>ProcessGroup</i> ", the tokens MAY also be the name of a gray box that needs expansion. See <i>@Category</i> for more details. Values include those from: ▶ Chapter 6 Processes.
<i>Version</i> ? Modified in JDF 1.2	enumeration	Scope and Position is Root and Descendent. Text that identifies the version of the JDF node. The <i>@Version</i> attribute is REQUIRED in the JDF root node but OPTIONAL in child nodes. The version of a JDF node is defined by the highest version of the JDF node itself or any child JDF node or element or any directly or indirectly linked resources. For details on JDF versioning see ▶ Section 3.13 JDF Versioning. Allowed value is from: ▶ JDFJMFVersion.
<i>xmlns</i> ? New in JDF 1.1	URI	Scope and Position is Root and Descendent. JDF supports use of XML namespaces. The namespace SHALL be declared in the root JDF element. For details on using namespaces in XML, see ▶ [XMLNS]. For versions 1.1 through 1.6 of JDF , <i>@xmlns</i> = " http://www.CIP4.org/JDFSchema_1_1 ".
<i>xsi:type</i> ? New in JDF 1.2	NMTOKEN	Scope and Position is Local. Informs schema aware validators of the JDF node type definition that the containing node is to be validated against. The schema for this version includes definitions for all the JDF nodes defined in Section 6. If omitted, then a general definition for JDF nodes will be used. See ▶ Section 3.2 JDF.

Table 3.4: JDF (Sheet 4 of 4)

NAME	DATA TYPE	DESCRIPTION
AncestorPool ?	element	Scope and Position is Root. If this element is present, the current JDF node has been spawned, and this element contains a list of all Ancestor elements prior to spawning. See ▶ Section 3.4 AncestorPool.
AuditPool ?	element	Scope and Position is Local. List of elements that contains all relevant audit information. Audit elements are intended to serve the requirements of MIS for evaluation and post calculation. See ▶ Section 3.11 AuditPool and Audit.
CustomerInfo ? Deprecated in JDF 1.3	element	Scope and Position is Descendent. Container element for customer-specific information. See ▶ Section 3.5 CustomerInfo. In JDF 1.3 and beyond, CustomerInfo is a resource that is referenced through a CustomerInfoLink in the ResourceLinkPool .
JDF *	element	Scope and Position is Local. Child JDF nodes. The nesting of JDF nodes defines the JDF tree.
NodeInfo ? Deprecated in JDF 1.3	element	Scope and Position is Local. Container element for process-specific information such as scheduling and messaging setup. Scheduling affects the planned times when a node is to be executed. Actual times are saved in the AuditPool . See ▶ Section 3.11 AuditPool and Audit. In JDF 1.3 and beyond, NodeInfo is a resource that is referenced through a NodeInfoLink in the ResourceLinkPool .
ResourceLinkPool ?	element	Scope and Position is Local. Container element for ResourceLink elements, which describe the input and output resources of the node. See ▶ Section 3.9 ResourceLinkPool and ResourceLink.
ResourcePool ?	element	Scope and Position is Local. Container element for resources. See ▶ Section 3.8 ResourcePool and its Resource Children. Note: Resources are local in a ResourcePool but MAY be referenced from ResourceLink elements in descendent nodes. For details see ▶ Section 3.9 ResourceLinkPool and ResourceLink.
StatusPool ? Deprecated in JDF 1.3	element	Scope and Position is Local. Container for PartStatus elements that specify the details of a node's partition dependent @Status related attributes if the @Status of the node is "Pool". Deprecation note: Starting with JDF 1.3, StatusPool/PartStatus/@Status is replaced by NodeInfo/@NodeStatus in the respective partition of NodeInfo .

3.2.1 ICS Versions Value

To assist with interoperability conformance the **JDF** can refer to one or more **CIP4** Interoperability Conformance Specification documents. Each document is referenced by using an NMTOKEN that complies with the following:

Value format: <ICSName>_L<ICSLevel>-<ICSVersion>.

Example: MISPRE_L1-1.3 for the MIS to Prepress ICS. If there is a revision to that ICS: "MISPRE_L1-1.3.1". See ▶ Section 11.5 Interoperability Conformance Specifications for more information on ICS documents.

3.2.2 Structure Diagram of JDF Node

► Figure 3-2: JDF node structure shows the structure of the **JDF** node. Arrows point to child elements.

Figure 3-2: JDF node structure^a

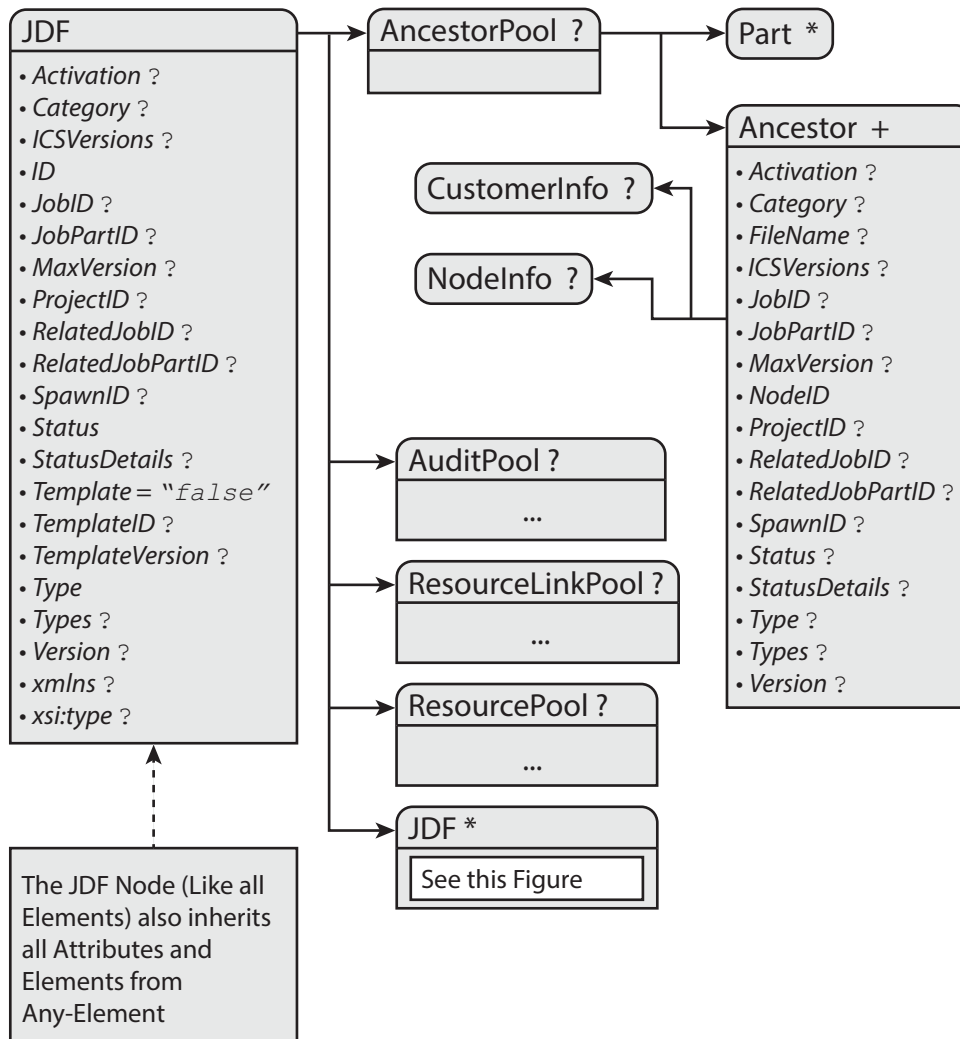

a. In addition to the items shown, the JDF element like all other elements, inherits all generic elements and attributes. See ► Table 3.1 Any Element (generic content)

3.3 Common Node Types

As was noted in the preceding section, the @Type of a node can fall into four categories. The first is comprised of the specific processes of the kind delineated in ► Chapter 6 Processes, known simply as process nodes. The other categories are made up of three enumerative values of the @Type attribute: "ProcessGroup", "Combined" and "Product", which is also known as Product Intent. These three node types are described in this section.

The figure below, which was also presented as an illustration in Chapter 2, represents a theoretical job hierarchy comprised of product intent nodes, process group nodes and nodes that represent individual or combined processes. The diagram is divided into three levels to help illustrate the difference between the three kinds of nodes, but these levels do not dictate the hierarchical nesting mechanism of a job. Note, however, that an individual process node MAY be the child of a product intent node without first being the child of a process group node. Likewise, a process group node MAY have child nodes that are also process groups.

Figure 3-3: Job hierarchy with Process, Process Group and Product Intent nodes

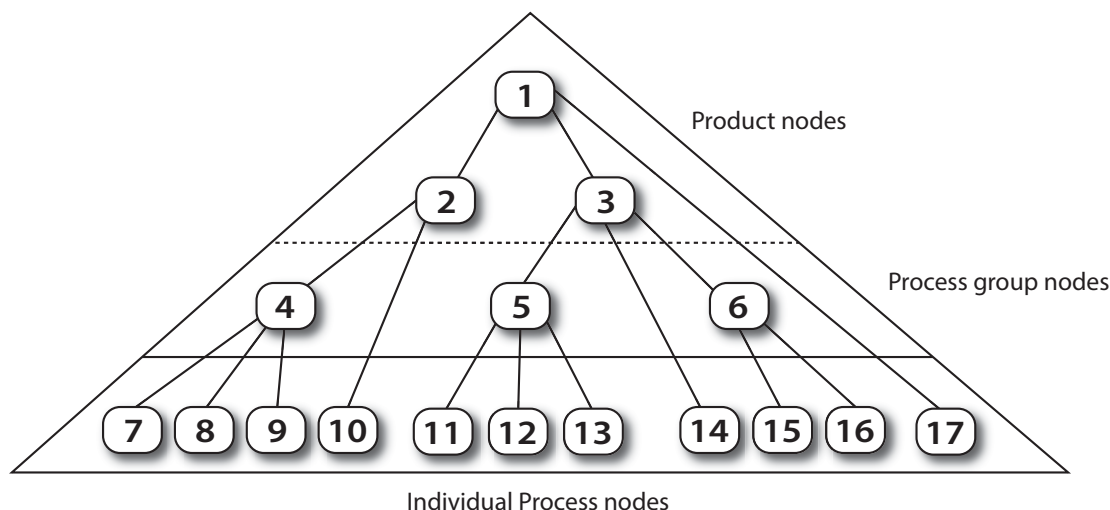

3.3.1 Product Intent Nodes

Except in certain specific circumstances, the agent assigned to begin writing a **JDF** job will very likely not know every process detail needed to produce the desired results. For example, an agent that is a job-estimating or job-submission tool might not know what devices can execute various steps or even which steps will be needed.

If this is the case, the initiating agent creates a set of top-level nodes to specify the product intent without providing any of the processing details. Subsequent agents then add nodes below these top-level nodes to provide the processing details needed to fulfill the intent specified.

These top-level nodes SHALL have a `@Type` attribute value of "Product" to indicate that they do not specify any processing, (and are referred to as "Product Intent nodes"). All processing needed to produce the products described in these nodes SHALL be specified in process nodes, which exist lower in the job hierarchy.

Product intent nodes include **Intent Resources** that describe the end results the customer is requesting. The **Intent Resources** that have already been defined for **JDF** are easily recognizable, as they contain the word "intent" in their titles. Examples include **ColorIntent** and **FoldingIntent**. All **Intent Resources** share a set of common subelements, which are described in ▶ Section 7.1 Intent Properties Template. These resources do not attempt to define the processing needed to achieve the desired results; instead they provide a forum to define a range of acceptable possibilities for executing a job. Each product intent node SHOULD contain at most one **ResourceLink** for one type of **Intent Resource**. If multiple product parts with different intents are needed, each part has its own product intent node. **DeliveryIntent** resources are a notable exception. Specifying multiple **DeliveryIntent** resources effectively requests multiple options of a quote. A product intent node produces one or more **Component** resources as output resources. For more information about product intent, see ▶ Section 4.1.1 Product Intent Constructs.



Product Intent

"Product Intent" is another way of saying "Job Specifications". Rather than describing how a job will be made, Product Intent describes what a finished product (or some aspect of a product) will look like when it is completed. Product Intents can initiate with the customer and in rather vague terms, and they might be later fleshed out or completed by a printer's customer service representative, estimating department or production planners.

3.3.2 Process Group Nodes

Intermediate nodes in the **JDF** job hierarchy (i.e., nodes 4, 5 and 6 in ▶ Figure 3-3: Job hierarchy with Process, Process Group and Product Intent nodes) describe groups of processes. The `@Type` attribute value of these kinds of nodes is "ProcessGroup", (and they are referred to as "Process Group Nodes"). These nodes are used to describe multiple steps in a process chain that have common resources or scheduling data.

Since the agent writing the job has the option of grouping processes in any way that seems logical, custom workflows MAY be modeled flexibly. Process group nodes MAY contain further process group nodes, individual process nodes or a mixture of both node types. Sequencing of process group nodes SHOULD be defined by linking resources of the appropriate child **JDF** nodes.

The higher the level of the process group nodes within the hierarchy, the larger the number of processes the group contains. A high level process group node (e.g., prepress, finishing or printing processes) might include lower level process group nodes that define a set of individual steps which are executed as a group of steps in the individual workflow hierarchy. For example, all steps performed by one designated individual MAY be grouped in a lower level process group node.

3.3.2.1 Use of the Types Attribute in Process Group Nodes – Gray Boxes

New in JDF 1.2

Process group nodes MAY contain an OPTIONAL `@Types` attribute that allows a controller (e.g., an MIS system) to specify a minimum set of processes to be executed without specifying the complete list of processes or the exact structure or grouping of these processes into individual **JDF** nodes. Process group nodes that contain a `@Types` attribute are commonly referred to as ‘Gray Boxes’. Additional processes that are not included in `@Types` MAY be added during expansion of a gray box. A `ResourceLink/@CombinedProcessIndex` is used to map `ResourceLink` elements to `JDF/@Types` in the ProcessGroup. Process group nodes with a non-empty `@Types` attribute SHALL NOT be executed. A device that receives the process group node SHALL define the exact structure of the process group node by executing the following steps until the `@Types` list referenced by the process group node is empty:

Step 1 — Select at least one of the process types defined in `@Types` and remove these values from the `@Types` list of values referenced by the process group node.

Step 2 — Create one new **JDF** child node within the ProcessGroup that either:

- Has a `@Type` attribute matching the removed `@Types` entry value, or
- Is a **JDF** node with a `@Type` attribute value of `"Combined"` or `"ProcessGroup"` that contains the removed `@Types` value or values.

Step 3 — Link the appropriate resources that were predefined in the original process group node to the newly created subordinate **JDF** node(s). The `ResourceLink` SHALL either be retained or deleted from the process group node. If it is retained, the process group node SHALL NOT be executed before the resource that is linked by that `ResourceLink` is available. Otherwise, the process group node MAY be executed, even if the resource is not available.

Step 4 — Add missing `@Types` to the subordinate **JDF** node where appropriate. For instance, the original `@Types` attribute list referenced by process group node might have specified `"Interpreting Rendering"` or simply `"RIPing"`, but the newly created RIP node would specify `"Interpreting Rendering Trapping Screening"`.

Step 5 — Finalize the newly created subordinate **JDF** node by adding any missing resources and resource parameters. Note that newly created resources SHALL NOT be linked to the process group node but only to the subordinate **JDF** node created in this process.

An agent SHALL instantiate all of the processes in the `@Types` attribute of the gray box before releasing the created **JDF** nodes for processing and production. The ordering of the processes in the `@Types` attribute SHALL be maintained when instantiating the child nodes. **JDF** process group nodes that contain both a non-empty `@Types` attribute and child **JDF** nodes are *not* supported, although a process group node MAY contain child process group nodes that have non-empty `@Types` attribute.

3.3.2.2 Use of NamedFeature in Product and Process Group Nodes

New in JDF 1.2

Modified in JDF 1.5

Combined, process group and product intent nodes MAY contain zero or more `GeneralID[@Datatype="NamedFeature"]` elements. These `GeneralID` elements that are referred to as “NamedFeatures” in this paragraph allow a controller (e.g., an MIS system) to define a named set of parameters for processes that SHALL be executed without defining the details or even the resources for the individual **JDF** nodes. The agent (e.g., a prepress control system) populates the **JDF** node with the values implied by `NamedFeatures` in an implementation-defined manner. This procedure MAY include the addition of additional **JDF** subnodes. The precedence of parameters (attributes or elements) is as follows in order of decreasing precedence:

- Explicitly supplied parameters
- Parameters supplied by the device agent that are associated with the supplied `NamedFeatures` closest to the process.
- Parameters supplied by the device agent that are associated with the supplied `NamedFeatures` supplied by the device agent at node levels closer to the root.

An individual `NamedFeature` is selected by the `GeneralID/@IDUsage` and `GeneralID/@IDValue` that matches entries from `DeviceCap/FeaturePool/EnumerationState/@Name` and `DeviceCap/FeaturePool/EnumerationState/@AllowedValueList` (see `Section 10.2.1 DeviceCap`), where `GeneralID/@IDUsage` defines the name of the parameter set name (e.g., “Screening”), and `GeneralID/@IDValue` defines the selected parameter set value (e.g., “AM_HighRes”). Multiple `NamedFeatures` MAY be selected. Names and values are implementation dependent. Each `GeneralID/@IDUsage` SHALL occur only once in the `NamedFeatures` list.

Use of `NamedFeatures` is commonly combined with the use of `@Types` in process group nodes as described in `Section 3.3.2.1 Use of the Types Attribute in Process Group Nodes – Gray Boxes`. `JDF/@Types` abstractly specifies the set of processes to execute, whereas `NamedFeatures` abstractly specifies the set of resources for the processes specified in `@Types`.

3.3.2.3 ResourceLink Structure in Process Group Nodes

New in JDF 1.2

The contents of the **ResourceLinkPool** of a process group node define the resources that SHALL be available for the process group node itself to be executed.

Example 3.1: ResourceLink Structure for a ProcessGroup

The following example shows the **ResourceLink** structure for a "ProcessGroup" digital printing with near-line finishing node. The input **Media** is available and the output **Component** is of interest to the submitting controller. The **Parameter Resources** are assumed to be supplied by the sub-controller that executes the process group node. Note the presence of intermediate component links that link the individual processes. The corresponding **ResourcePool** elements and resource elements have been omitted for brevity.

```
<JDF ID="J1" JobPartID="ID300" Status="Waiting" Type="ProcessGroup"
  Version="1.6" xmlns="http://www.CIP4.org/JDFSchema_1_1">
  <!-- the ResourceLink Elements in the ProcessGroup define the Input
    Resources that are to be available for the ProcessGroup to be
    submitted and the Output Resources that are produced by the ProcessGroup
  -->
  <ResourcePool>
    <DigitalPrintingParams Class="Parameter" ID="L1" Status="Available"/>
    <Media Class="Consumable" ID="L2" Status="Available"/>
    <RunList Class="Parameter" ID="L8" Status="Available"/>
    <Component Class="Quantity" ComponentType="Sheet" ID="L3" Status="Unavailable"/>
    <GatheringParams Class="Parameter" ID="L4" Status="Available"/>
    <Component Class="Quantity" ComponentType="Sheet" ID="L5" Status="Unavailable"/>
    <StitchingParams Class="Parameter" ID="L6" Status="Available"/>
    <Component Class="Quantity" ComponentType="Sheet" ID="L7" Status="Unavailable"/>
  </ResourcePool>
  <ResourceLinkPool>
    <!-- print input media -->
    <MediaLink Usage="Input" rRef="L2"/>
    <!-- gathered output components -->
    <ComponentLink Usage="Output" rRef="L7"/>
  </ResourceLinkPool>
</JDF ID="J2" JobPartID="ID301" Status="Waiting" Type="DigitalPrinting">
  <ResourceLinkPool>
    <!-- digital printing parameters -->
    <DigitalPrintingParamsLink Usage="Input" rRef="L1"/>
    <!-- input sheets -->
    <MediaLink Usage="Input" rRef="L2"/>
    <RunListLink Usage="Input" rRef="L8"/>
    <!-- printed output components -->
    <ComponentLink Usage="Output" rRef="L3"/>
  </ResourceLinkPool>
</JDF ID="J3" JobPartID="ID302" Status="Waiting" Type="Gathering">
  <ResourceLinkPool>
    <!-- gathering parameters -->
    <GatheringParamsLink Usage="Input" rRef="L4"/>
    <!-- printed output components -->
    <ComponentLink Usage="Input" rRef="L3"/>
    <!-- gathered output components -->
    <ComponentLink Usage="Output" rRef="L5"/>
  </ResourceLinkPool>
</JDF ID="J4" JobPartID="ID303" Status="Waiting" Type="Stitching">
  <ResourceLinkPool>
    <!-- Stitching parameters -->
    <StitchingParamsLink Usage="Input" rRef="L6"/>
    <!-- gathered output components -->
    <ComponentLink Usage="Input" rRef="L5"/>
    <!-- stitched output components -->
    <ComponentLink Usage="Output" rRef="L7"/>
  </ResourceLinkPool>
</JDF>
</JDF>
```

3.3.3 Combined Process Nodes

The processes described in ▶ Chapter 6 Processes define individual workflow steps that are assumed to be executed by a single-purpose device. Many devices, however, are able to combine the functionality of multiple single-purpose devices and execute more than one process. For example, a digital printer might be able to execute the **Interpreting**, **Rendering** and **DigitalPrinting** processes. To accommodate such devices, **JDF** allows processes to be grouped within a node whose **@Type** = "**Combined**", (referred to as "Combined Process Nodes"). Such a node SHALL also contain a **@Types** attribute, which in turn contains an ordered list of the **@Type** values of each of processes that the node specifies. The ordering of the process names in the **@Types** attribute specifies the ordering in which the processes SHOULD be executed. If the final product result would be indistinguishable, the device MAY change the execution order of the processes from that given in the **@Types** attribute.

Furthermore, **ResourceLink** elements in combined process nodes SHOULD specify a **@CombinedProcessIndex** attribute in order to define the subprocess to which the resource belongs. Combined process nodes are leaf nodes and SHALL NOT contain further nested **JDF** nodes.

A device with multiple processing capabilities is able to recognize the combined process node as a single unit of work that it can execute. All input and output resources that are consumed and produced externally by the process SHALL be specified in the **ResourceLinkPool** element of the node. This includes all REQUIRED **Parameter Resources** as well as the initial input resources and final output resources. Intermediate resources that are internally produced and consumed NEED NOT be specified.

In a combined process node, the information defined by the various resources linked as input to the various subprocesses are logically available to all processes of the combined process node. In situations where the **Parameter Resource** of more than one subprocess specifies the mapping of sheet surface content to media, the subprocess that specifies such a mapping that is defined earliest in the **@Types** attribute list SHALL be used, and any other mappings specified by any downstream subprocess resource SHALL be ignored.

3.3.3.1 Combined Process Nodes with Multiple Processes of the Same Type

A combined process node MAY contain multiple instances of the same process type (e.g., **@Types** = "**Cutting Folding Cutting**"). In this case, the ordering and mapping of links processes is significant — the parameters of the first **Cutting** process are most likely to be different from those of the second **Cutting** process. Mapping is accomplished using the **@CombinedProcessIndex** attribute in the respective **ResourceLink**.

Example 3.2: Combined Process Node

```

<JDF ID="J1" JobPartID="ID345" Status="Waiting" Type="Combined"
  Types="Cutting Folding Cutting" Version="1.6" xmlns="http://www.CIP4.org/JDFSchema_1_1">
  <!--Resources (incomplete...) -->
  <ResourcePool>
    <!-- parameters of the first Cutting Process-->
    <CuttingParams Class="Parameter" ID="L1" Status="Available"/>
    <!-- Folding parameters -->
    <FoldingParams Class="Parameter" ID="L2" Status="Available"/>
    <!-- parameters of the second Cutting Process-->
    <CuttingParams Class="Parameter" ID="L3" Status="Available"/>
    <!-- raw input components -->
    <Component Class="Quantity" ComponentType="Sheet" ID="L4" Status="Available"/>
    <!-- completed output components -->
    <Component Class="Quantity" ComponentType="Sheet" ID="L5" Status="Unavailable"/>
  </ResourcePool>
  <!-- Links -->
  <ResourceLinkPool>
    <!-- parameters of the first Cutting Process-->
    <CuttingParamsLink CombinedProcessIndex="0" Usage="Input" rRef="L1"/>
    <!-- Folding parameters -->
    <FoldingParamsLink CombinedProcessIndex="1" Usage="Input" rRef="L2"/>
    <!-- parameters of the second Cutting Process-->
    <CuttingParamsLink CombinedProcessIndex="2" Usage="Input" rRef="L3"/>
    <!-- raw input components -->
    <ComponentLink Usage="Input" rRef="L4"/>
    <!-- completed output components -->
    <ComponentLink Usage="Output" rRef="L5"/>
  </ResourceLinkPool>
</JDF>

```

Example 3.3: ResourceLinkPool for Combined Process Node

The following example of the *ResourceLinkPool* of a **JDF** node describes digital printing with in-line finishing and includes the same processes as the previous *ProcessGroup* example. The node requires the *Parameter Resources* and *Consumable Resources* of all three processes as inputs, and produces a completed booklet as output. The intermediate printed sheets and gathered piles are not declared, since they exist only internally within the device and cannot be accessed or manipulated by an external controller.

```

<JDF ID="J1" JobPartID="ID200" Status="Waiting" Type="Combined"
  Types="DigitalPrinting Gathering Stitching" Version="1.6" xmlns="http://www.CIP4.org/JDFSchema_1_1">
  <ResourceLinkPool>
    <!-- digital printing input RunList -->
    <RunListLink CombinedProcessIndex="0" Usage="Input" rRef="L1"/>
    <!-- digital printing parameters -->
    <DigitalPrintingParamsLink CombinedProcessIndex="0" Usage="Input" rRef="L2"/>
    <!-- gathering parameters -->
    <GatheringParamsLink CombinedProcessIndex="1" Usage="Input" rRef="L3"/>
    <!-- Stitching parameters -->
    <StitchingParamsLink CombinedProcessIndex="2" Usage="Input" rRef="L4"/>
    <!-- input sheets -->
    <MediaLink CombinedProcessIndex="0" Usage="Input" rRef="L5"/>
    <!-- stitched output components -->
    <ComponentLink CombinedProcessIndex="2" Usage="Output" rRef="L6"/>
  </ResourceLinkPool>
  <ResourcePool>
    <RunList Class="Parameter" ID="L1" Status="Available"/>
    <DigitalPrintingParams Class="Parameter" ID="L2" Status="Available"/>
    <GatheringParams Class="Parameter" ID="L3" Status="Available"/>
    <StitchingParams Class="Parameter" ID="L4" Status="Available"/>
    <Media Class="Consumable" ID="L5" Status="Available"/>
    <Component Class="Quantity" ComponentType="Sheet" ID="L6" Status="Unavailable"/>
  </ResourcePool>
</JDF>

```

3.3.3.2 Specifying non-linear dependencies in a Combined Process Node

A combined process node typically specifies a linear execution chain of the individual process steps defined in *JDF/@Types*. A device that executes a combined process node MAY execute a more complex network of individual work steps. For instance, a cover might be printed from one tray and an insert printed from another tray. Both are to be bound to produce a single output bound component. This behavior is modeled by explicitly declaring the exchange resource and by defining it as a pipe by specifying *Resource/@PipeID* and *Resource/@PipeProtocol* = "Internal". The exchange resource is then linked to the correct processes in the combined process node by using both an input and an output *ResourceLink* element. Multiple input *ResourceLink* elements and/or multiple output *ResourceLink* elements MAY be declared. *Resource/@Status* of the exchange resource SHALL allow execution of the node.

Figure 3-4: Combined Process node dependencies

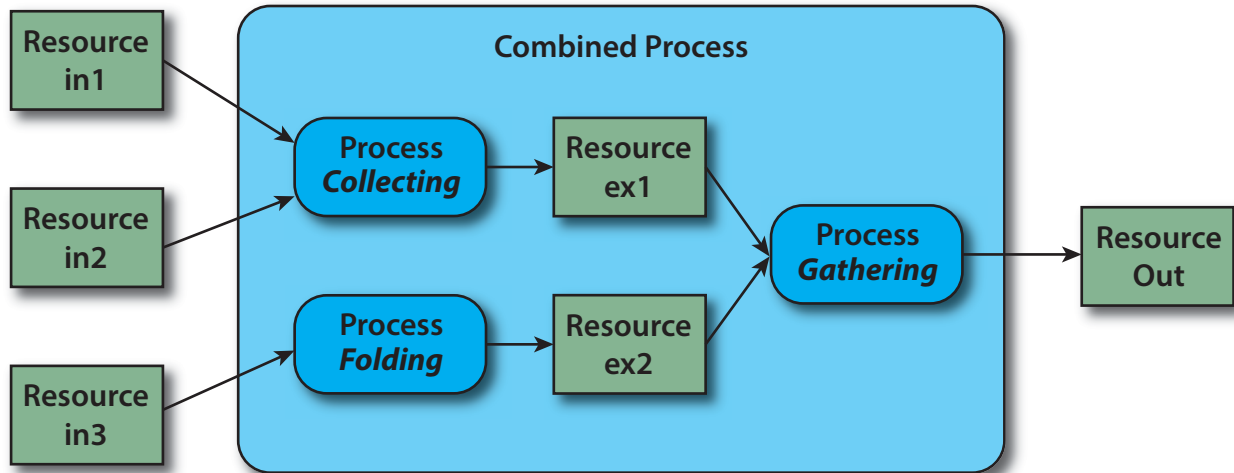

Example 3.4: Complex Combined Process Node

The following example specifies an inline combined folder and collector and gatherer.

```

<JDF ID="ID" JobPartID="ID345" Status="Waiting" Type="Combined"
  Types="Collecting Gathering Folding" Version="1.6" xmlns="http://www.CIP4.org/JDFSchema_1_1">
  <ResourcePool>
    <GatheringParams Class="Parameter" ID="gp1" Status="Available"/>
    <FoldingParams Class="Parameter" ID="fp1" Status="Available"/>
    <Component Class="Quantity" ComponentType="Sheet" ID="in1" Status="Available"/>
    <Component Class="Quantity" ComponentType="Sheet" ID="in2" Status="Available"/>
    <Component Class="Quantity" ComponentType="Sheet" ID="in3" Status="Available"/>
    <Component Class="Quantity" ComponentType="Sheet" ID="ex1"
      PipeID="ex1" PipeProtocol="Internal" Status="Unavailable"/>
    <Component Class="Quantity" ComponentType="Sheet" ID="ex2"
      PipeID="ex2" PipeProtocol="Internal" Status="Unavailable"/>
    <Component Class="Quantity" ComponentType="Sheet" ID="Out" Status="Unavailable"/>
  </ResourcePool>
  <ResourceLinkPool>
    <GatheringParamsLink Usage="Input" rRef="gp1"/>
    <FoldingParamsLink Usage="Input" rRef="fp1"/>
    <ComponentLink CombinedProcessIndex="0" Usage="Input" rRef="in1"/>
    <ComponentLink CombinedProcessIndex="0" Usage="Input" rRef="in2"/>
    <ComponentLink CombinedProcessIndex="2" Usage="Input" rRef="in3"/>
    <ComponentLink CombinedProcessIndex="0" Usage="Output" rRef="ex1"/>
    <ComponentLink CombinedProcessIndex="2" Usage="Output" rRef="ex2"/>
    <ComponentLink CombinedProcessIndex="1" Usage="Input" rRef="ex1"/>
    <ComponentLink CombinedProcessIndex="1" Usage="Input" rRef="ex2"/>
    <ComponentLink CombinedProcessIndex="1" Usage="Output" rRef="Out"/>
  </ResourceLinkPool>
</JDF>

```

3.3.4 Process Nodes

Process nodes represent the very lowest level in a job hierarchy. They SHALL NOT contain further nested JDF nodes, as every process node is a leaf node. These nodes define the smallest work unit that can be scheduled and executed individually within the JDF workflow model. In ▶ Figure 3-6: Nodes linked by a resource below, nodes 7-17 represent process nodes. The various individual process node types are specified in ▶ Section 6 Processes.

3.4 AncestorPool

When a job is spawned, an **AncestorPool** is created in the spawned **JDF** to identify its parents and grandparents. This allows storing of information about job context in a spawned node as well as allowing the job to be correctly merged with its parent after it is completed. The **AncestorPool** element is only REQUIRED in the root of a spawned **JDF**. Spawning and merging are described in ▶ Section 4.4 Spawning and Merging. The **AncestorPool** element contains an ordered list of one or more **Ancestor** elements, which reflect the family tree of a spawned **JDF**. Each **Ancestor** element identifies exactly one ancestor node.

The ancestor nodes reside in the original job where the job with the **AncestorPool** has been spawned off. The position of the **Ancestor** element in the ordered list defines the position in the family tree. The first element in the list is the original root element, the last element in the list is the parent, the last but one, the grandparent and so on. The following table lists the contents of an **AncestorPool** element.



Ancestor Pool

An ancestor pool contains the job's context when the job is spawned. This includes scheduling information and possibly customer information.

Table 3.5: AncestorPool Element

NAME	DATA TYPE	DESCRIPTION
Ancestor +	element	Ordered list of one or more Ancestor elements, which reflect the family tree of a spawned JDF .
Part * New in JDF 1.1	element	List of parts that this node was spawned with. Used in case of parallel spawning of a node. This defines the aggregated Part (s) in the case of nested spawns (i.e., a logical AND of all spawned Part (s)). For instance, the JDF that was spawned with a @SheetName partition and subsequently spawned with a @Separation would contain both @SheetName and @Separation within Part .

3.4.1 Ancestor

An **Ancestor** element SHALL contain read-only copies of all the attributes of the node that it represents with the exception of the **@ID** attribute, which SHALL be copied to the **@NodeID** attribute of that **Ancestor** element. **Ancestor** elements MAY contain further read-only references to **CustomerInfo** and **NodeInfo**. The attributes and elements of **Ancestor** elements are described below.

Table 3.6: Ancestor Element (Sheet 1 of 3)

NAME	DATA TYPE	DESCRIPTION
Activation ?	enumeration	Copy of the @Activation attribute from the ancestor node. For details, see ▶ Table 3.4 JDF. Allowed value is from: ▶ Activation.
Category ? New in JDF 1.2	NMTOKENS	Copy of the @Category attribute from the original ancestor node. For details, see ▶ Table 3.4 JDF. Allowed values are from: ▶ Node Categories.
FileName ?	URL	The URL of the JDF file where the ancestor node resided prior to spawning. Note: Despite the name of this attribute, @URL NEED NOT refer to a physical file. @URL MAY refer to any url scheme where the original JDF can be accessed, e.g. http.
ICSVersions ? New in JDF 1.2	NMTOKENS	Copy of the @ICSVersions attribute from the original ancestor node. For details, see ▶ Table 3.4 JDF, and also refer to ▶ Section 3.2.1 ICS Versions Value.
JobID ?	string	Copy of the @JobID attribute from the original ancestor node. For details, see ▶ Table 3.4 JDF.
JobPartID ?	string	Copy of the @JobPartID attribute from the original ancestor node. For details, see ▶ Table 3.4 JDF.

Table 3.6: Ancestor Element (Sheet 2 of 3)

NAME	DATA TYPE	DESCRIPTION
<i>MaxVersion</i> ? New in JDF 1.2	enumeration	Copy of the <i>@MaxVersion</i> attribute from the original ancestor node. For details, see ▶ Table 3.4 JDF. Allowed value is from: ▶ JDFJMFVersion.
<i>NamedFeatures</i> ? New in JDF 1.2 Deprecated in JDF 1.5	NMTOKENS	Copy of the <i>@NamedFeatures</i> attribute from the original ancestor node. For details, see ▶ Table 3.4 JDF.
<i>NodeID</i>	NMTOKEN	Copy of the <i>@ID</i> attribute of the ancestor node. Note: NMTOKEN is used as the datatype and not ID because the ancestor node and thus <i>@ID</i> does not reside in the spawned JDF . The corresponding <i>@ID</i> attribute resides in the original JDF .
<i>ProjectID</i> ?	string	Identification of the project context that this JDF belongs to. Used by the application that created the JDF job.
<i>RelatedJobID</i> ? New in JDF 1.2	string	Copy of the <i>@RelatedJobID</i> attribute from the original ancestor node. For details, see ▶ Table 3.4 JDF.
<i>RelatedJobPartID</i> ? New in JDF 1.2	string	Copy of the <i>@RelatedJobPartID</i> attribute from the original ancestor node. For details, see ▶ Table 3.4 JDF.
<i>RelatedProjectID</i> ? New in JDF 1.6	string	Copy of the <i>@RelatedProjectID</i> attribute from the original ancestor node. For details, see ▶ Table 3.4 JDF.
<i>SpawnID</i> ? New in JDF 1.1	NMTOKEN	Copy of the <i>@SpawnID</i> attribute of the ancestor node.
<i>Status</i> ?	enumeration	Copy of the <i>@Status</i> attribute from the original ancestor node. For details, see ▶ Table 3.4 JDF. Allowed value is from: ▶ Status.
<i>StatusDetails</i> ? New in JDF 1.2	string	Copy of the <i>@StatusDetails</i> attribute from the original ancestor node. For values and details, see ▶ Table 3.4 JDF. Values include those from: ▶ Status Details.
<i>Template</i> = "false" New in JDF 1.1	boolean	Copy of the <i>@Template</i> attribute from the original ancestor node. For details, see ▶ Table 3.4 JDF.
<i>TemplateID</i> ? New in JDF 1.2	string	Copy of the <i>@TemplateID</i> attribute from the original ancestor node. For details, see ▶ Table 3.4 JDF.
<i>TemplateVersion</i> ? New in JDF 1.2	boolean	Copy of the <i>@TemplateVersion</i> attribute from the original ancestor node. For details, see ▶ Table 3.4 JDF.
<i>Type</i> ?	NMTOKEN	Copy of the <i>@Type</i> attribute from the original ancestor node. For details, see ▶ Table 3.4 JDF. Allowed values include: Combined ProcessGroup Product And those from: ▶ Chapter 6 Processes.
<i>Types</i> ?	NMTOKENS	Copy of the <i>@Types</i> attribute from the original ancestor node. For details, see ▶ Table 3.4 JDF. Allowed values are from: ▶ Chapter 6 Processes.
<i>Version</i> ?	enumeration	Copy of the <i>@Version</i> attribute from the original ancestor node. For details, see ▶ Table 3.4 JDF. Allowed value is from: ▶ JDFJMFVersion.

Table 3.6: Ancestor Element (Sheet 3 of 3)

NAME	DATA TYPE	DESCRIPTION
CustomerInfo ? New in JDF 1.1 Modified in JDF 1.3	reference	Reference to or copy of the CustomerInfo element or resource from the original node. In JDF 1.3 and beyond, CustomerInfo SHOULD be a resource reference. For details, see ▶ Table 3.4 JDF.
NodeInfo ? New in JDF 1.1 Modified in JDF 1.3	reference	Reference to or copy of the NodeInfo element or resource from the original node. In JDF 1.3 and beyond, NodeInfo SHOULD be a resource reference. For details, see ▶ Table 3.4 JDF.

3.5 CustomerInfo

Deprecated in JDF 1.3

Starting with **JDF** 1.3, **CustomerInfo** is deprecated in its use as a direct child of a **JDF** node, and is now a resource (which is a child of some **ResourcePool**; see ▶ Section 3.8 ResourcePool and its Resource Children).

3.6 NodeInfo

Deprecated in JDF 1.3

Starting with **JDF** 1.3, **NodeInfo** is deprecated in its use as a direct child of a **JDF** node, and is now a resource (which is a child of some **ResourcePool**; see ▶ Section 3.8 ResourcePool and its Resource Children).

3.7 StatusPool

Deprecated in JDF 1.3.

Starting with **JDF** 1.3, **StatusPool** is deprecated and replaced by a partitioned **NodeInfo** resource.

3.8 ResourcePool and its Resource Children

3.8.1 ResourcePool

All resources are contained in the **ResourcePool** element of some node. The **ResourcePool** element is described in the following table.

Table 3.7: ResourcePool Element

NAME	DATA TYPE	DESCRIPTION
Resource *	element	List of Resource elements. The Resource elements are abstract and serve as placeholders for any resource type.

3.8.2 Resource

Resources represent the “things” that are produced or consumed by processes. They might be physical items such as inks, plates or glue; electronic items such as files or images; or conceptual items such as parameters and device settings. Processes describe what resources they input or output through **ResourceLink** elements, discussed in ▶ Section 3.9 ResourceLinkPool and ResourceLink. By examining the input and outputs of a set of processes, it is possible to determine process dependencies, and therefore job routing.

3.8.3 Abstract Resource

Like the **@Type** attribute in abstract **JDF** nodes, the **@Class** attribute in **Resource** elements helps to identify how particular resources are to be used. These values are listed in ▶ Table 3.8 Abstract Resource Element, below, and are described in greater detail in the sections that follow.

Modification note: **GeneralID** has moved to ▶ Table 3.1 Any Element (generic content).

Table 3.8: Abstract Resource Element (Sheet 1 of 4)

NAME	DATA TYPE	DESCRIPTION
AgentName ? New in JDF 1.2	string	The name of the agent application that created the resource. Both the company name and the product name MAY appear, and SHOULD be consistent between versions of the application.

Table 3.8: Abstract Resource Element (Sheet 2 of 4)

NAME	DATA TYPE	DESCRIPTION
<i>AgentVersion</i> ? New in JDF 1.2	string	The version of the agent application that created the resource. The format of the version string MAY vary from one application to another, but SHOULD be consistent for an individual application.
<i>Author</i> ? New in JDF 1.2	string	Text that identifies the person who generated the resource.
<i>CatalogID</i> ? Deprecated in JDF 1.4	string	Identification of the resource (e.g., in a catalog environment). Defaults to the value of <i>@ProductID</i> . Deprecation note: Starting with JDF 1.4, use <i>GeneralID</i> .
<i>CatalogDetails</i> ? Deprecated in JDF 1.4	string	Additional details of a resource in a catalog environment. Deprecation note: Starting with JDF 1.4, use <i>GeneralID</i> .
<i>Class</i> Modified in JDF 1.5	enumeration	Defines the abstract resource type. For details, see the sections that follow. <i>@Class</i> SHALL be specified in the resource root, SHALL NOT be specified in a resource leaf and SHOULD NOT be specified in an inline resource subelement. Allowed values are from: ▶ ResourceClass.
<i>ID</i>	ID	Unique identifier of a resource. <i>@ID</i> SHALL be specified in the resource root, SHALL NOT be overwritten in a resource leaf and SHOULD NOT be specified in an inline resource subelement.
<i>Locked</i> ="false"	boolean	If "true", the resource SHALL NOT be modified (e.g., because it resides in a spawned ticket that is spawned in read-only mode or referenced by an <i>Audit</i> and SHALL NOT be modified without invalidating the <i>Audit</i>).
<i>PartUsage</i> = "Explicit" New in JDF 1.1 Modified in JDF 1.3	enumeration	Description of the interpretation of partitions. <i>@PartUsage</i> SHALL NOT be specified outside of the root of a resource. For details on <i>@PartUsage</i> and partitioning, see ▶ Section 3.10.7.4 Implicit, Sparse and Explicit PartUsage in Partitioned Resources. Allowed values are: Explicit – Require explicit partition matches. All referenced partitions referenced in <i>Part</i> SHALL exist, otherwise it is an error. Implicit – The closest matching partition with no non-matching partition keys is returned. If keys with non-matching values exist, the first partition element that is closer to the root than the referenced partition and has no non-matching keys is returned. Sparse – The closest matching partition with no non-matching partition keys is returned. If keys with non-matching values exist the link is in error. <i>@PartUsage</i> = "Sparse" is typically used to describe versioned resources, where not all nodes are fully partitioned (e.g., only the black Separations of a 4 color resource are versioned). New in JDF 1.3 Modification note: <i>@PartUsage</i> was moved to this table from ▶ Table 3.21 Partitionable Resource Element in JDF 1.2.
<i>PipeID</i> ?	string	If this attribute exists, the resource is a pipe. <i>@PipeID</i> is used by JMF pipe-control messages to identify the pipe. For more information, see ▶ Section 4.3.3 Overlapping processing Using Pipes.

Table 3.8: Abstract Resource Element (Sheet 3 of 4)

NAME	DATA TYPE	DESCRIPTION
PipeProtocol ? New in JDF 1.2 Modified in JDF 1.5	NMTOKEN	<p>Defines the protocol use for pipe handling. "JMF" and "Internal" are the only non-proprietary piping protocols that are supported. Proprietary pipe protocols MAY be specified in addition to those defined below but will not necessarily be inter-operable.</p> <p>Values include:</p> <p>IdentificationField – For barcode push. The pipe data is provided by barcodes that are defined in IdentificationField elements.</p> <p>Internal – Internal or virtual pipe used within a combined process.</p> <p>JMF – JMF-based PipePush/PipePull messages. The sequence of pipe initialization is undefined. See next two values: "JMFPush" and "JMFPull".</p> <p>JMFPush – JMF based PipePush/PipePull protocol. The producing device initiates the protocol. New in JDF 1.5</p> <p>JMFPull – JMF based PipePush/PipePull protocol. The consuming device initiates the protocol. New in JDF 1.5</p> <p>None – No pipe support.</p>
PipeURL ? New in JDF 1.2 Deprecated in JDF 1.5	URL	<p>Pipe request URL. Dynamic pipe requests to this resource SHOULD be made to this URL. Note that this URL is only used for initiating pipe requests. Responses to a pipe request are issued to the URL that is defined in the PipePush or PipePull message. For details on using @PipeURL, see ▶ Section 4.3.3 Overlapping processing Using Pipes.</p> <p>Note: In most cases @PipeURL is the URL of the controller of the <i>other end</i> of the pipe. This might seem counterintuitive, but it allows parallel spawning and merging of processes that represent a dynamic pipe without having to include the node that describes the other end in the spawned file.</p> <p>Deprecation note: Starting with JDF 1.5, use ResourceLink/@PipeURL.</p>
ProductID ?	string	<p>An ID of the resource as defined in the MIS system. For instance item codes or article numbers or identifiers on semi-finished products or Handling Resources.</p>
rRefs ? Deprecated in JDF 1.2	IDREFS	<p>Array of IDs of internally referenced resources.</p> <p>In JDF 1.2 and beyond, it is up to the implementation to maintain references.</p>
SkipIndex ? New in JDF 1.5	integer	<p>Number of indexed partition leaves to omit when evaluating the respective XXXIndex partitions. Valid only on partition leaves or branches where the partition key is one of the XXXIndex keys (e.g., @SetIndex). Used when an index range comprises every Nth index. For example, a range of @SheetIndex = "1000 ~ 2000" with @SkipIndex = "1" would comprise a list starting at @SheetIndex = "1000" including every other index (1000, 1002, 1004, etc.) with a maximum value of @SheetIndex = "2000".</p>
SpawnIDs ? New in JDF 1.1	NMTOKENS	<p>List of @SpawnID values. This is used as a reference count for how often the resource has been spawned.</p>
SpawnStatus = "NotSpawned"	enumeration	<p>The spawn status of a resource indicates whether or not a resource has been spawned, and under what circumstances. The @SpawnStatus of a resource that has ResourceRef elements is defined as the maximum @SpawnStatus (whose values are ordered) of all recursively linked resources.</p> <p>Value are ordered from lowest to highest</p> <p>Allowed values are:</p> <p>NotSpawned — Indicates that the resource has not been copied to another process.</p> <p>SpawnedRO – Indicates that the resource has been copied to another process where it cannot be modified. The "RO" stands for read-only.</p> <p>SpawnedRW – Indicates that the resource has been copied to another process where it can be modified. The "RW" stands for read/write.</p>

Table 3.8: Abstract Resource Element (Sheet 4 of 4)

NAME	DATA TYPE	DESCRIPTION
<i>Status</i> Modified in JDF 1.2	enumeration	The status of a resource indicates under what circumstances it can be processed or modified. <i>@Status</i> SHALL be specified in the resource root, SHALL NOT be specified in an inline resource subelement and MAY be overwritten in a resource leaf. The values listed below are assumed to be ordered so that the <i>@Status</i> of a resource that references further resources can be defined as the minimum <i>@Status</i> of all recursively linked resources. The values are ordered from lowest to highest Allowed values are from: ▶ ResourceStatus.
<i>UpdateID</i> ? New in JDF 1.1 Deprecated in JDF 1.3	NMTOKEN	Unique ID that identifies the <i>Resource</i> or resource partition. Note that only one <i>Resource</i> , resource partition or <i>ResourceUpdate</i> with a given value of <i>@UpdateID</i> MAY occur per JDF document, even though the scope of the <i>ResourceUpdate</i> is local to the resource that it is defined in.
<i>QualityControlResult</i> * New in JDF 1.2	refelement	Results of quality measurements which were performed during or after the production of this resource.
<i>SourceResource</i> * New in JDF 1.3	element	List of resources that were or SHOULD be taken into account to populate this resource.

3.8.3.1 SourceResource

Table 3.9: SourceResource Element

NAME	DATA TYPE	DESCRIPTION
<i>Resource</i>	refelement	Reference to resources that were or SHOULD be taken into account to populate this <i>Resource</i> . <i>Resource</i> is an abstract element that MAY reference either process resources or <i>Intent Resources</i> that contain information that is used to populate this resource. Note that resource is an abstract type and designates any valid JDF resource (e.g., <i>StrippingParams</i> or <i>ColorIntent</i>). This element SHALL NOT be an inline <i>Resource</i> .

3.8.4 Structure Diagram

▶ Figure 3-5: ResourcePool and abstract resource element structure shows the structure of the abstract resource classes defined above. Arrows define inheritance relations and the thin orthogonal lines describe containing relations.

Figure 3-5: ResourcePool and abstract resource element structure

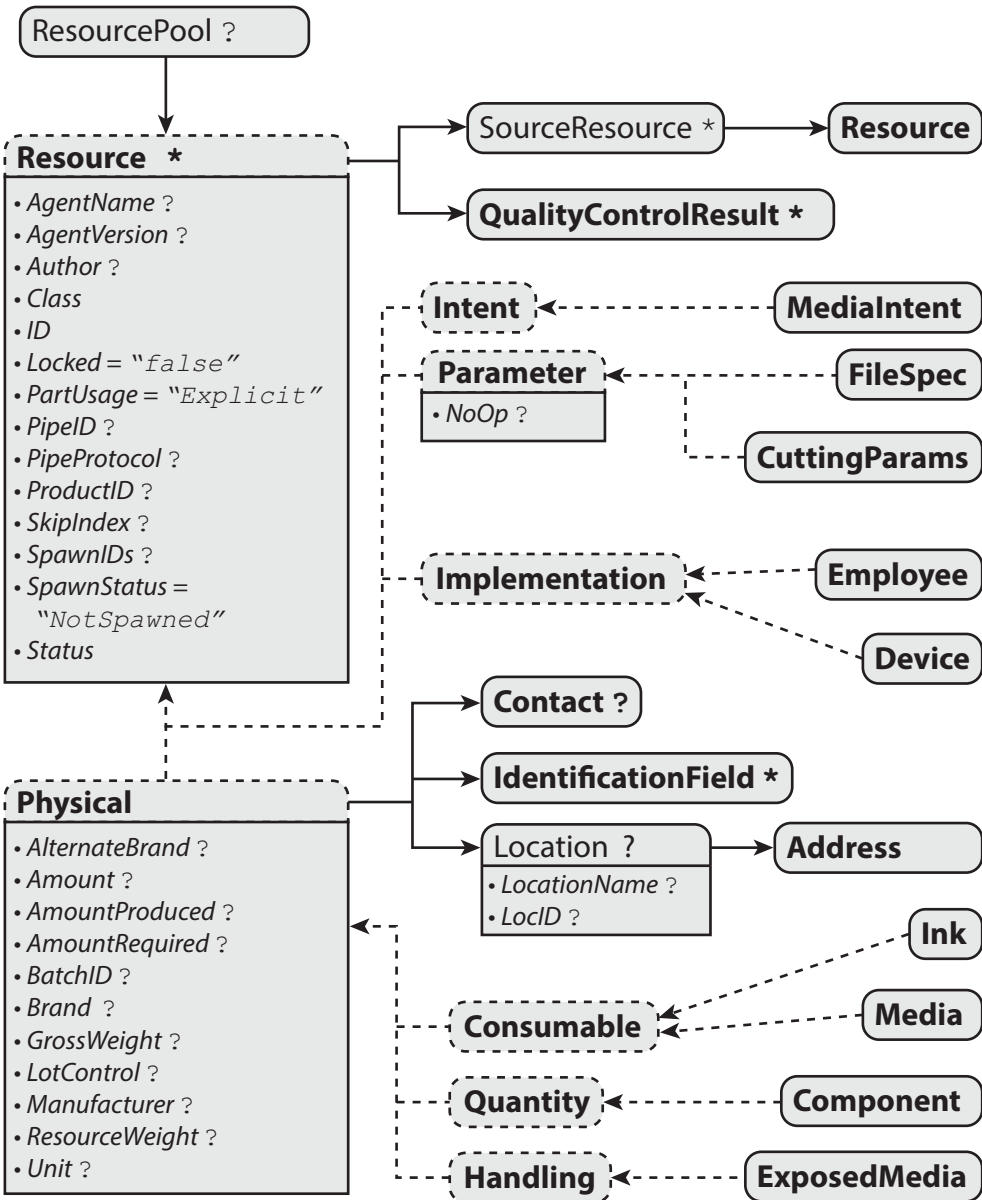

3.8.5 Resource Classes

The following sections describe the functions of each of the seven values of the @Class attribute. All resources fall into one of these classes. In Chapter 7 Product Intent and Chapter 8 Resources, the class of each resource is indicated in the resource properties subheading.

3.8.5.1 Parameter Resource

Parameter Resources define the details of processes, as well as any non-physical computer data such as files used by a process. They are usually associated with a specific process. For example, a REQUIRED input resource of the DigitalPrinting process is the DigitalPrintingParams resource. Most predefined Parameter Resources contain the suffix "Params" in their titles. Examples of Parameter Resources include FoldingParams and ConventionalPrintingParams.



Parameter & Intent Resources

Parameter and Intent Resources are information about the job. Intent Resources might originate in the customer's RFQ and might include information such as trim size, the number of colors and so on. Later on in the process of estimating and scheduling the job, these intents might be transformed into parameters for production process.

3.8.5.1.1 Abstract Parameter Resource

Table 3.10: Abstract Parameter Resource Element

NAME	DATA TYPE	DESCRIPTION
<i>NoOp</i> = "false" New in JDF 1.1	boolean	A value of "true" indicates that the process step that is parameterized by this Resource or resource partition SHALL NOT be executed. If "false" or not specified, the Resource is operational and that the process step that is parameterized by this Resource or resource partition SHALL be executed. The <i>@NoOp</i> attribute SHALL only be used for processes that input and output exchange resources of identical resource types (e.g., RunList or Component).

3.8.5.2 Intent Resource

Intent Resource define the details of products to be produced without defining the process to produce them. In addition, they provide structures to define sets of allowable options and to match these selections with prices. The details of all **Product Intent** are described in ▶ Chapter 7 Product Intent. The abstract **Intent Resource** element contains no attributes or elements besides those contained in the **Abstract Resource** element.

3.8.5.3 ImplementationResource

ImplementationResources define the devices and operators that execute a given node. Only two **ImplementationResource** types are defined: **Employee** (see ▶ Section 8.53 Employee) and **Device** (see ▶ Section 8.44 Device)

ImplementationResources can only be used as input resources and MAY be linked to any process. The abstract **ImplementationResource** element contains no attributes or elements besides those contained in the **Abstract Resource** element. An example demonstrating how to use **ImplementationResource**s is provided in ▶ Section Example 3.5: EmployeeLink.

Note that if a node links to a **Device** resource in order to specify that the device is intended to execute the node, the **Device** resource SHOULD NOT specify the capabilities of the device.

3.8.5.4 Consumable Resource

A **Consumable Resource** is consumed during a process. Examples include **Ink** and **Media**. **Consumable Resources** are the unmodified inputs in a process chain. A **Consumable Resource** is a **PhysicalResource** and inherits the contents of the **Abstract PhysicalResource** element.

3.8.5.5 Quantity Resource

A **Quantity Resource** has been created by a process from either a **Consumable Resource** or an earlier **Quantity Resource**. For example, printed sheets are cut and a pile of cut blocks is created. A **Component** resource is an example of a **Quantity Resource**. A **Quantity Resource** is a **PhysicalResource** and inherits the contents of the **Abstract PhysicalResource** element.

3.8.5.6 Handling Resource

A **Handling Resource** is used during a process, but is not destroyed by that process. The **ExposedMedia** and **Tool** resources are examples of such a resource, although it does describe various kinds of items such as film and plates. A **Handling Resource** MAY be created from a **Consumable Resource**. A **Handling Resource** is a **PhysicalResource** and inherits the contents of the **Abstract PhysicalResource** element.

3.8.5.7 PhysicalResource

A **PhysicalResource** is a **Resource** that is a **Consumable Resource**, a **Quantity Resource** or a **Handling Resource** (whose *@Class* is "Consumable", "Quantity" or "Handling", respectively):

3.8.5.7.1 Abstract PhysicalResource

▶ Table 3.11 Abstract PhysicalResource Element, defines the additional attributes and elements that can be defined for **PhysicalResources**. The processes that consume **PhysicalResources**—any kind of **PhysicalResource**—have the option of using these attributes and elements to determine in what way the resources are to be consumed.



Automating Inventory Management

JDF's handling of PhysicalResources provides a bridge between your JDF enabled systems and inventory management, ordering and replenishing systems. This opens the door to just-in-time inventory management driven by real-time scheduling and consumption data.

Table 3.11: Abstract PhysicalResource Element

NAME	DATA TYPE	DESCRIPTION
<i>AlternateBrand</i> ?	string	Information, such as the manufacturer or type, about a resource compatible to that specified by the <i>@Brand</i> attribute, which is described below.
<i>Amount</i> ?	double	Actual amount of the resource that is available. Note that the amount of consumption and production of a node is specified in the corresponding <i>ResourceLink</i> element. For details on amount handling, see ▶ Section 3.10.4 Resource Amount. For the unit of measurement, see the <i>@Unit</i> attribute below.
<i>AmountProduced</i> ? New in JDF 1.2	double	Total amount of the resource that has been produced by all nodes that reference this resource as output. This corresponds to the sum of all <i>@ActualAmount</i> values of output <i>ResourceLink</i> elements of leaf JDF nodes with <i>@Status</i> = "Completed" that reference this resource. For the unit of measurement, see the <i>@Unit</i> attribute below.
<i>AmountRequired</i> ?	double	Total amount of the resource that is referenced by all nodes that will consume this resource. This corresponds to the sum of all <i>@Amount</i> values of input <i>ResourceLink</i> elements of all processes that consume this resource. In case the resource is the last resource in a process chain, <i>@AmountRequired</i> specifies the sum of all <i>@Amount</i> values of all output <i>ResourceLink</i> elements that produce this resource. For the unit of measurement, see the <i>@Unit</i> attribute below.
<i>BatchID</i> ?	string	ID of a specific batch of the <i>PhysicalResource</i>
<i>Brand</i> ? Modified in JDF 1.3	string	Information, such as the model, part number and/or type, about the resource being used. Some examples are as follows. <ul style="list-style-type: none"> • Premium InkProp Glossy 6x642A • Premium Multipurpose 1234, 88 Bright 24 lb. Bond, 8-1/2 x 11, White Copy Paper Reorder 4711 Prior to JDF 1.3, <i>@Brand</i> included details of the <i>@Manufacturer</i> , which SHOULD be specified in <i>@Manufacturer</i> .
<i>GrossWeight</i> ? New in JDF 1.3	double	Gross weight of a single resource, as counted in <i>@Amount</i> , in grams.
<i>LotControl</i> ? New in JDF 1.3	enumeration	Specifies whether the resource is lot controlled. Allowed values are: Controlled – Resource is lot controlled, lot usage SHOULD be reported in resourceAudit elements. NotControlled – Resource is not lot controlled.
<i>Manufacturer</i> ? New in JDF 1.3	string	Specifies the manufacturer of the resource.
<i>ResourceWeight</i> ? New in JDF 1.1	double	Net weight of a single resource, as counted in <i>@Amount</i> , in grams.
<i>Unit</i> ?	NMTOKEN	Unit of measurement for the values of <i>@Amount</i> , <i>@AmountProduced</i> and <i>@AmountRequired</i> . Values include those from: ▶ Units. Note: Units other than those defined in the above table SHOULD NOT be specified.
<i>Contact</i> ?	refelement	If this element is specified, it describes the owner of the resource.
<i>IdentificationField</i> * New in JDF 1.1	refelement	If this element is specified, a bar code or label is associated with this <i>PhysicalResource</i> .
<i>Location</i> ?	element	Description of details of the location of this resource. Note, in order to describe multiple locations, resources MAY be partitioned by the <i>@Location</i> partition key as described in ▶ Section 3.10.5 Description of Partitioned Resources.

3.8.5.7.2 Location

Table 3.12: Location Element

NAME	DATA TYPE	DESCRIPTION
LocationName ? New in JDF 1.1	string	Name of the location (e.g., in MIS). This allows the user to describe distributed resources. Values include those from: ▶ Input Tray and Output Bin Names. Note: The specified values are for printer locations.
LocID ?	string	Location identifier (e.g., within a warehouse system).
Address	element	Address of the storage facility. For more information, see ▶ Section 9.1 Address.

3.8.5.8 Placeholder Resource

Deprecated in JDF 1.5

The [Placeholder Resource](#) has been deprecated starting with JDF 1.5.

3.8.6 Position of Resources within JDF Nodes

Resources MAY exist in any **JDF** node, but **JDF** nodes SHALL reference only local or global resources. In other words, **JDF** nodes SHALL reference resources only in the two kinds of locations: in the node's own [ResourcePool](#) element, or in **JDF** nodes that are hierarchically closer to the **JDF** root. An exception to this rule, however, occurs if two independent jobs are merged for a process step and are to be separated afterwards, as is the case when two independent jobs are printed on the same web press.

It is good practice to put resources into the closest node that references the resource. For example, the [RenderingParams](#) resource SHOULD be located in the [Rendering](#) node, unless it is used by multiple [Rendering](#) processes, in which case it SHOULD be located in the process group node that contains the [Rendering](#) process nodes. Resources that link more than one node SHOULD be placed in the parent node of the siblings that are linked by the resource.

A process that needs additional detailed process information specifying the creation of a resource SHALL infer this information by explicitly linking to the appropriate [Parameter Resource](#).

3.8.7 Pipe Resources

A pipe describes the resource dependency in which a process begins to consume a resource while it is being produced by another process (e.g., stacking components while they are being printed) or consuming a data stream while it is being written by an upstream process. Note that defining a pipe resource does not automatically set up communication between processes. The controllers/agents that execute the process SHALL still implement the protocol that defines the pipe.

Using dynamic pipe control, a downstream process can control the total quantity produced by an upstream process, and/or the quantity buffered by an inter-Process transport device (i.e., conveyor belt). Additional description of pipes and process communication via pipes is provided in ▶ Section 4.3.3 Overlapping processing Using Pipes.

Resources MAY contain a string attribute called [@PipeID](#) that declares the resource to be a pipe, and identifies it in a dynamic-pipe messaging environment. A pipe that is also controlled by **JMF** pipe messages is called **dynamic pipe**. For more information about dynamic pipes, see ▶ Section 4.3.3.1 Dynamic Pipes.

3.8.8 ResourceUpdate

New in JDF 1.1,

Deprecated in JDF 1.3

3.9 ResourceLinkPool and ResourceLink

3.9.1 ResourceLinkPool

Each **JDF** node contains a [ResourceLinkPool](#) element that in turn contains all of the [ResourceLink](#) elements that link the node to the resources it uses. The following table shows the contents of a [ResourceLinkPool](#) element.

Table 3.13: ResourceLinkPool Element

NAME	DATA TYPE	DESCRIPTION
<i>ResourceLink</i> *	element	List of <i>ResourceLink</i> elements. A <i>ResourceLink</i> element is abstract and is a placeholder for a concrete <i>ResourceLink</i> element, such as <i>MediaLink</i> .

3.9.2 ResourceLink

ResourceLink elements describe what resources a node uses, and how it uses them. They also define whether the resources are inputs or outputs. These inputs and outputs provide conceptual links between the execution elements of **JDF** nodes. Outputs of one node can in turn become inputs of another node, and a given node SHALL NOT be executed before *@Status* all specified input resources is greater than or equal to *ResourceLink/@MinStatus* or *ResourceLink/@MinLateStatus*.¹ The figure below shows two processes that are linked by a resource. The resource represents the output of ‘Node 1’, which in turn becomes an input for ‘Node 2’.

Figure 3-6: Nodes linked by a resource

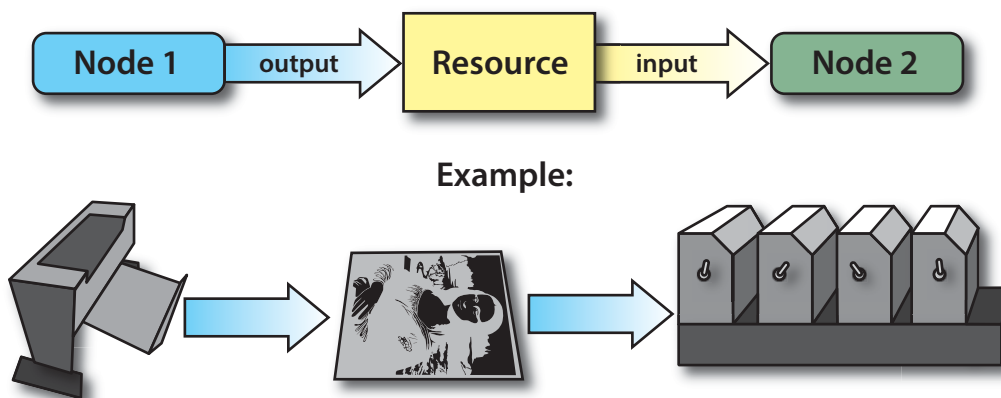

ResourceLink elements also allow node dependencies to be calculated. The following diagram summarizes resource linking within a **JDF** node. In this example there are two resources, A and B, which are placed in the node’s *ResourcePool*. To reference the resources, the node has two *ResourceLink* elements, ALink and BLink, in the *ResourceLinkPool*. A *ResourceLink* is named by appending “Link” to the type of resource referenced. Resource B also contains a reference to resource A, called ARef. References to resources from within resources are named by appending “Ref” to the type of resource referenced (see ▶ Section 3.10.2 ResourceRef – Element for Inter-Resource Linking and reelement).

Figure 3-7: ResourceLink elements and ResourceRef elements

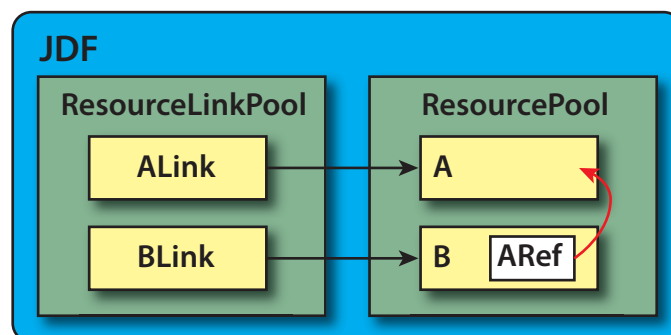

The previous section describes resources used by the node in which it resides. This section describes how resources can serve as links between nodes. As was described in ▶ Section 2.3 JDF Workflow, any resource that is the output of one process will very likely serve as an input of a subsequent process. Furthermore, some resources are shared between ancestor nodes and their child nodes.

1. The availability of a resource that is consumed as a whole is given by the *Resource* attribute *@Status* = "Available". In the case of pipe resources, the availability depends on the individual parameter defining the dynamics of a pipe. For details see ▶ Section 4.3.3 Overlapping processing Using Pipes.

ResourceLink elements MAY also contain attributes to select a part of a resource, such as a single separation. A detailed description of resource partitioning is given in ▶ Section 3.10.5 Description of Partitioned Resources.

Because implementation **ResourceLink** elements define the usage of a specific device during the course of a job, situations can arise where that resource is not needed during the whole processing time. For instance, a forklift that only has to transport the completed components need not be available during the entire process run, only during the times when it is needed. This means that, contrary to the general rule that all resources SHALL be "Available" for node execution to commence, a node can commence when **ImplementationResources** are still "InUse" by other processes if **@Start** or **@StartOffset** are specified. **ResourceLink** elements always have a **@Usage** of "Input".

ProcessGroup and product intent nodes can be defined without the knowledge of the individual process nodes that define a specific workflow. In this case, these intermediate nodes will contain **ResourceLink** elements that link the appropriate resources. For example, a prepress node might be defined that produces a set of plates. When the processes for creating the plates are defined in detail, the agent that writes the nodes might remove the **ResourceLink** elements from the intermediate node. Removing the **ResourceLink** specifies that the intermediate node can execute (i.e., it can be sent to the appropriate controller or department), even though the specific resources are not yet available. If the **ResourceLink** elements are not removed, the intermediate node cannot execute until the linked input resources become available.

ResourceLink elements MAY be used for process control. For example, if a proof input resource is needed for a print process, a print run can commence only when the proof is signed. The **JDF** format specification also includes a complete specification of how resources are managed when **JDF** tickets are spawned and merged.

In some cases, determining whether to store information in an input or an output resource can be difficult, as the distinction can be ambiguous. For example, is the definition of the color of a separation in the RIP process a property of the output separation or a parameter that describes the RIP process? In order to reduce this ambiguity, the following rules have been defined for input and output resources of processes (see ▶ Chapter 6 Processes and ▶ Chapter 8 Resources).

- Product intent and process parameters are generally input resources, except when one process defines the parameters of a subsequent process.
- **Consumable Resources** SHALL always be input resources.
- **Quantity Resources** and **Handling Resources** are used both as input resources and output resources. Their usage is defined by the "natural" process usage. For example, a printing plate is described as a resource that is the output of a process and the input of a process.
- Processed material is exchanged from node to node using the **Component** resource. Product intent nodes also create **Component** output resources.
- Every detailed process description SHALL be defined as an input parameter of the first process where it is referenced. This means that a device SHALL NOT infer process parameters from its output resources. For example, paper weight in grams MAY be defined in the **Component** output resource of the printing process but SHALL be defined as an input parameter of the **Media** of the printing process.
- Any resource parameter that is used SHALL be referenced explicitly. Resource parameters cannot be inferred by following the chain of nodes backwards. This would make spawning of nodes non-local.
- The last process in a chain of processes SHALL define the output resource of its parent process.
- In case of parallel processing, the sum of the outputs of all parallel subnodes SHALL define the output of the parent node.

Like **Resource** elements, **ResourceLink** elements are an abstract data type. The class tree of abstract **ResourceLink** elements is further subdivided into classes defined by the **@Class** attribute of the resource that it references. Individual instances of **ResourceLink** elements are named by appending the suffix "Link" to the name of the referenced resource. For example, the link to a **Component** resource is entitled **ComponentLink** and the link to a **ScanParams** resource is entitled **ScanParamsLink**.

It is important to note that the order of occurrence of links to **PhysicalResources** MAY be significant. For example, a **Gathering** process might have among its inputs links to three **Component** resources. The order of these links indicates the order in which the **Component** resources are to occur in the new, gathered output **Component**.

Note: Starting with **JDF** 1.5 **ConsumableLink**, **HandlingLink**, **ImplementationLink**, **ParameterLink**, **PlaceHolderLink** and **QuantityLink** have been removed and all their attributes and subelements moved to **ResourceLink**.

3.9.3 Structure Diagram

► Figure 3-8: ResourceLinkPool and ResourceLink element – a diagram of the structure shows the abstract types derived from the **ResourceLink** type.

Figure 3-8: ResourceLinkPool and ResourceLink element – a diagram of the structure

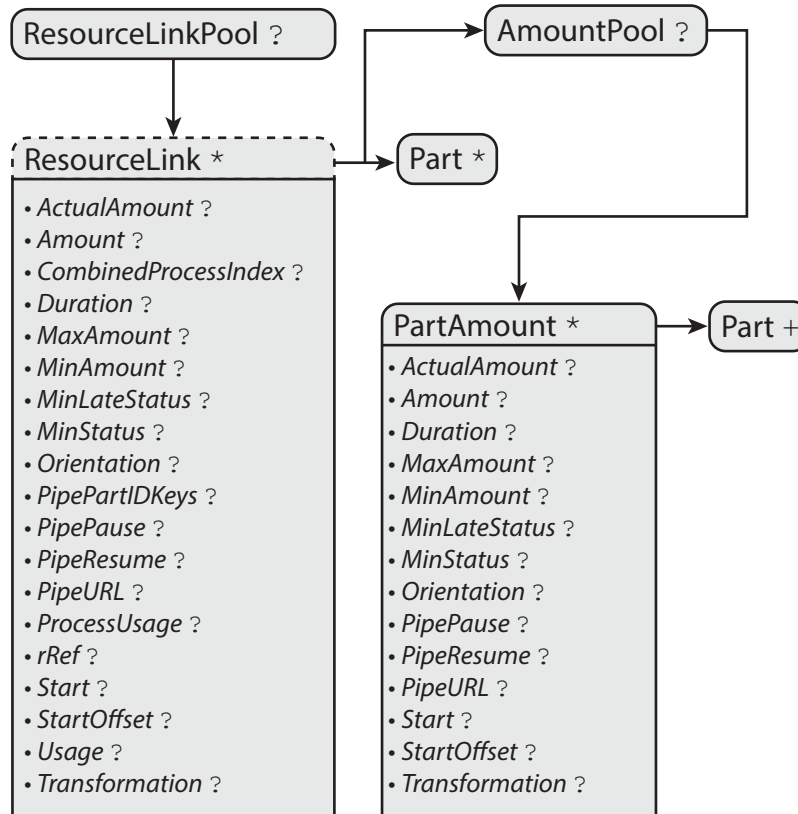

The following table lists the possible contents of all **ResourceLink** elements.

Table 3.14: ResourceLink Element (Sheet 1 of 4)

NAME	DATA TYPE	DESCRIPTION
<i>ActualAmount</i> ? New in JDF 1.2	double	Total amount of the resource that has been produced (in a ResourceLink with @Usage = "Output") or consumed (in a ResourceLink with @Usage = "Input") by this node in every execution. For details see ► Section 3.10.4 Resource Amount. Note: In JDF 1.5 @ActualAmount was moved from deleted abstract PhysicalLink .
<i>Amount</i> ?	double	For a link with a @Usage of "Input" , specifies the amount of the resource that is needed by the process, in units as defined in the resource. For a link with a @Usage of "Output" , specifies the amount of the resource that is to be produced by the process, in units as defined in the resource. Allows resources to be only partially consumed or produced (see ► Section 3.10.4 Resource Amount). If not specified, ResourceLink/@Amount defaults to Resource/@Amount . Note: In JDF 1.5 @ActualAmount was moved from the deleted abstract PhysicalLink .

Table 3.14: ResourceLink Element (Sheet 2 of 4)

NAME	DATA TYPE	DESCRIPTION
<i>CombinedProcessIndex</i> ? New in JDF 1.1	IntegerList	Combined process nodes and process group nodes MAY contain resources from multiple process nodes. The <i>@CombinedProcessIndex</i> attribute specifies the indices of individual processes in the <i>@Types</i> attribute to which a <i>ResourceLink</i> in a combined process nodes or process group node belongs. Multiple entries in <i>@CombinedProcessIndex</i> specify that the <i>ResourceLink</i> is used by the respective multiple processes in the combined process node. It SHALL be specified when multiple resources of the same name and <i>ResourceLink/@Usage</i> are specified in one JDF node. If <i>@CombinedProcessIndex</i> is not specified, even though multiple processes in the combined process node or process group node MAY link to the resource, the <i>ResourceLink</i> applies to all of these processes.
<i>CombinedProcessType</i> ? Deprecated in JDF 1.1	NMTOKEN	Combined process nodes contain input resources from multiple process nodes. The <i>@CombinedProcessType</i> attribute specifies the name individual process to which a <i>ResourceLink</i> in a combined process node belongs. It SHALL match one of the entries in the <i>@Types</i> attribute of the node. Deprecation note: <i>@CombinedProcessType</i> was replaced by <i>@CombinedProcessIndex</i> in JDF 1.1.
<i>DraftOK</i> ? Deprecated in JDF 1.3	boolean	If "true", the process can commence with a draft resource. Default = "false". Replaced with <i>@MinLateStatus</i> and <i>@MinStatus</i> in JDF 1.3 and beyond.
<i>Duration</i> ? Modified in JDF 1.4	duration	Estimated duration during which the resource will be used. Modification note: Starting with JDF 1.4, <i>@Duration</i> is moved from abstract <i>ImplementationLink</i> table, which was then deleted in JDF 1.5.
<i>MaxAmount</i> ? New in JDF 1.3	double	Defines the planned <i>@Amount</i> including the maximum overage. If not specified, defaults to a system specified value based on <i>@Amount</i> . Note: In JDF 1.5 <i>@MaxAmount</i> was moved from the deleted abstract <i>PhysicalLink</i> .
<i>MinAmount</i> ? New in JDF 1.3	double	Defines the planned <i>@Amount</i> including the maximum underage that the customer is willing to accept. If not specified, defaults to a system specified value based on <i>@Amount</i> . Note: In JDF 1.5 <i>@MinAmount</i> was moved from the deleted abstract <i>PhysicalLink</i> .
<i>MinLateStatus</i> ? New in JDF 1.3	enumeration	Minimum value of <i>Resource/@Status</i> for the execution of this node to commence when deadlines are endangered (i.e., when the time defined by <i>NodeInfo/@LastStart</i> or implied by <i>NodeInfo/@LastEnd</i> is approaching). Default value is from: <i>@MinStatus</i> . Allowed values are from: ▶ ResourceStatus.
<i>MinStatus</i> ? New in JDF 1.3	enumeration	Minimum value of <i>Resource/@Status</i> for the execution of this node to commence. Default value is: "Available" if <i>@Usage</i> = "Input" and "Unavailable" if <i>@Usage</i> = "Output". Allowed values are from: ▶ ResourceStatus.
<i>Orientation</i> ? New in JDF 1.1	enumeration	Named orientation describing the transformation of the orientation of a <i>PhysicalResource</i> relative to the ideal process coordinate that uses this resource as input or output. If <i>@Orientation</i> is specified for an output resource, the node that processes the <i>PhysicalResource</i> is to manipulate the resource in such a way as to reflect the transformation. The coordinate system of the resource itself is <i>not</i> modified. At most one of <i>@Orientation</i> or <i>@Transformation</i> SHALL be specified. For details on coordinate systems, see ▶ Section 2.6 Coordinate Systems in JDF. Note: In JDF 1.5 <i>@Orientation</i> was moved from the deleted abstract <i>PhysicalLink</i> . Allowed value is from: ▶ Orientation

Table 3.14: ResourceLink Element (Sheet 3 of 4)

NAME	DATA TYPE	DESCRIPTION
<i>PipePartIDKeys</i> ? Deprecated in JDF 1.6	enumerations	Defines the granularity of a dynamic pipe for a partitioned resource. For instance, if a resource were partitioned by sheet, surface and separation (i.e., <i>Resource/@PartIDKeys</i> = "SheetName Side Separation") and if the <i>ResourceLink/@PipePartIDKeys</i> = "SheetName Side", then pipe requests would be issued only once per surface. The contents of <i>@PipePartIDKeys</i> SHALL be a subset of the <i>@PartIDKeys</i> attribute of the resource that is linked by this <i>ResourceLink</i> . Default value is from: the implied or explicit value of <i>@PipePartIDKeys</i> of the referenced resource. Allowed values are from: ▶ Table 3.22 PartIDKey Attribute Values.
<i>PipePause</i> ?	double	Parameter for controlling the pausing of a process if the resource amount in the pipe buffer passes the specified value. For details on using <i>@PipePause</i> , see ▶ Section 4.3.3 Overlapping processing Using Pipes. Note: In JDF 1.5 <i>@PipePause</i> was moved from the deleted abstract <i>PhysicalLink</i> .
<i>PipeProtocol</i> ? New in JDF 1.1 Modified in JDF 1.2 Deprecated in JDF 1.5	NMTOKEN	Defines the protocol use for pipe handling. See ▶ Section 4.3.3 Overlapping processing Using Pipes. "JMF" and "Internal" are the only non-proprietary piping protocols that are supported. Proprietary pipe protocols MAY be specified in addition to those defined below but will not necessarily be interoperable. Default value is: "JMF" (if <i>@PipeURL</i> is specified); otherwise referenced <i>Resource/@PipeProtocol</i> . Values include: <i>Internal</i> – Internal or virtual pipe used within a combined process. New in JDF 1.2 <i>JMF</i> – JMF based <i>PipePush</i> / <i>PipePull</i> messages. <i>None</i> – No pipe support. Deprecation note: Starting with JDF 1.5, use <i>Resource/@PipeProtocol</i> .
<i>PipeResume</i> ?	double	Parameter for controlling the resumption of a process if the resource amount in the pipe buffer passes the specified value. For details on using <i>@PipeResume</i> , see ▶ Section 4.3.3 Overlapping processing Using Pipes. Note: In JDF 1.5 <i>@PipeResume</i> was moved from the deleted abstract <i>PhysicalLink</i> .
<i>PipeURL</i> ? Modified in JDF 1.2	URL	Pipe request URL. Dynamic pipe requests from this end of a pipe SHOULD be made to this URL. In most cases this URL is the URL of the controller of the <i>other end</i> of the pipe. This might seem counterintuitive, but it allows parallel spawning and merging of processes that represent a dynamic pipe without having to include the node that describes the other end in the spawned file. Default value is: referenced <i>Resource/@PipeURL</i> Note: <i>@PipeURL</i> is only used for initiating pipe requests. Responses to a pipe request are issued to the URL that is defined in the <i>PipePush</i> or <i>PipePull</i> message. For details on using <i>@PipeURL</i> , see ▶ Section 4.3.3 Overlapping processing Using Pipes.
<i>ProcessUsage</i> ? Modified in JDF 1.4 Modified in JDF 1.6	NMTOKEN	Identifies a process's usage of a resource if multiple resources of the same type can be supplied. For example, this attribute appears when two <i>Component</i> resources—one cover and one book block—are used in <i>CoverApplication</i> . Values include those from either: ▶ Process Usage. Or from any additional values in: ICS documents. New in JDF 1.4 Note: The values of <i>@ProcessUsage</i> can be derived from the appropriate process descriptions in ▶ Section 6 Processes. ▶ Section 6.1 Process Template defines the parenthesized notation for denoting the value of <i>@ProcessUsage</i> (e.g., <i>Component</i> (<i>Cover</i>)).
<i>Recommendation</i> ? Deprecated in JDF 1.2	boolean	If "true" and the request cannot be fulfilled, the change MAY be logged as a <i>Modified</i> audit and the job can continue. If "false", an error occurs if the request is not fulfilled. In JDF 1.2 and beyond use <i>@SettingsPolicy</i> instead. Note: In JDF 1.5 <i>@Recommendation</i> was moved from the deleted abstract <i>ImplementationLink</i> .

Table 3.14: ResourceLink Element (Sheet 4 of 4)

NAME	DATA TYPE	DESCRIPTION
RemotePipeEndPause ? Deprecated in JDF 1.5	double	Parameter for controlling the pausing of a process at the other end of the pipe if the resource amount in the pipe buffer passes the specified value. For details on using @RemotePipeEndPause , see ▶ Section 4.3.3 Overlapping processing Using Pipes. Note: In JDF 1.5 @RemotePipeEndPause was moved from the deleted abstract PhysicalLink . Deprecation note: Starting with JDF 1.5, use @PipePause .
RemotePipeEndResume ? Deprecated in JDF 1.5	double	Parameter for controlling the resumption of a process at the other end of the pipe if the resource amount in the pipe buffer passes the specified value. For details on using @RemotePipeEndResume , see ▶ Section 4.3.3 Overlapping processing Using Pipes. Note: In JDF 1.5 @RemotePipeEndResume was moved from the deleted abstract PhysicalLink . Deprecation note: Starting with JDF 1.5, use @PipeResume .
rRef	IDREF	Link to the target resource.
rSubRef ? Deprecated in JDF 1.2	IDREF	Link to a subelement within the resource. In JDF 1.2 and beyond, a ResourceLink is able to reference a resource only if it is a direct child of a ResourcePool .
Start ? Modified in JDF 1.4	dateTime	Time and date when the usage of the resource starts. Note: In JDF 1.4 @Start was moved from the deleted abstract ImplementationLink , which was deleted in JDF 1.5.
StartOffset ? Modified in JDF 1.4	duration	Offset time when the resource is needed after processing has begun. If both @Start and @StartOffset are specified, @Start has precedence. Note: In JDF 1.4 @StartOffset was moved from the deleted abstract ImplementationLink , which was deleted in JDF 1.5.
Usage	enumeration	Resource usage within this JDF node. Allowed values are from: ▶ ResourceUsage.
Transformation ? New in JDF 1.1	matrix	Matrix describing the transformation of the orientation of a PhysicalResource relative to the ideal process coordinate using this resource as input or output. If @Transformation is specified for an output resource, the node that processes the PhysicalResource is to manipulate the resource in such a way as to reflect the transformation. The coordinate system of the resource itself is <i>not</i> modified. At most one of @Orientation or @Transformation SHALL be specified. For details on coordinate systems, see ▶ Section 2.6 Coordinate Systems in JDF. Note: In JDF 1.5 @Transformation was moved from the deleted abstract PhysicalLink .
AmountPool ? New in JDF 1.1 Modified in JDF 1.2	element	Definition of partial amounts and pipe parameters for this ResourceLink . The allowed contents of the AmountPool are described for the various subclasses of ResourceLink in the sections below. If AmountPool is specified, ResourceLink SHALL NOT contain any of @Amount , @ActualAmount , @MaxAmount or @MinAmount
Lot * New in JDF 1.3 Deprecated in JDF 1.6	element	Group of identifiers that uniquely identifies one lot of a resource. If multiple resource lots are planned to be consumed by a process, this element MAY appear multiple times to identify each resource lot. Examples of resource lots are individual rolls of paper, boxes of paper, cans of ink, etc. See ▶ Section 3.9.4 Identification of Physical Resources for details. For resources that are solely identified by @ProductID , Lot element(s) NEED NOT be specified. Note: @Lot was moved from abstract PhysicalLink which was deleted in JDF 1.5.
Part *	element	The Part elements identify the parts of a partitioned resource that are referenced by the ResourceLink . The structure of the Part element is defined in ▶ Table 3.23 Part Element. For details on partitioned resources, see ▶ Section 3.10.5 Description of Partitioned Resources.

Example 3.5: EmployeeLink

The following example shows how the operator Smith is linked to a **ConventionalPrinting** process as the only valid operator.

```
<ResourcePool>
  <Employee Class="Implementation" ID="L1" PersonalID="007" Status="Available">
    <Person FamilyName="Smith" JobTitle="Press Operator"/>
  </Employee>
</ResourcePool>
<ResourceLinkPool>
  <EmployeeLink Usage="Input" rRef="L1"/>
</ResourceLinkPool>
```

3.9.3.1 AmountPool and PartAmount

New in JDF 1.1

Whereas **ResourceLink/Part** identifies the **Resource** that the process is consuming or producing, **AmountPool** is a container for the amount-related metadata of the resource. Thus process routing is described by **ResourceLink/PartAmount/Part** whereas tracking of amount related attributes are described by **AmountPool/PartAmount**. **AmountPool/PartAmount/Part** SHALL refer to existing partitions or non-existing sub-partitions of existing partitions that are implicitly or explicitly referred to by **ResourceLink/Part**. For instance, if a **ResourceLink** refers to a partition with **@SheetName="Sheet1"**, **AmountPool/PartAmount** MAY refer to Sheet1 or any existing or non-existing child of Sheet1, but NOT to Sheet2 or any existing or non-existing child of Sheet2.

3.9.3.1.1 AmountPool

The following table lists the generic contents of an **AmountPool** element. Further parameters of the **AmountPool** are described in the sections below.

Table 3.15: AmountPool Element

NAME	DATA TYPE	DESCRIPTION
PartAmount *	element	Element that defines the amounts and pipe parameters for a partitioned resource. The contents of a PartAmount depends on the type of the ResourceLink

3.9.3.1.2 PartAmount

The following table lists the generic contents of a **PartAmount** element. Note that **PartAmount** inherits values from its parent **ResourceLink**.

Table 3.16: PartAmount Element (Sheet 1 of 3)

NAME	DATA TYPE	DESCRIPTION
ActualAmount ? New in JDF 1.2	double	Total amount of the resource that has been produced (in a ResourceLink with @Usage = "Output") or consumed (in a ResourceLink with @Usage = "Input") by this node in every execution. For details see ▶ Section 3.10.4 Resource Amount. Note: In JDF 1.5 @ActualAmount was moved from the deleted abstract PhysicalLink .
Amount ?	double	For a link with a @Usage of "Input" , specifies the amount of the resource that is needed by the process, in units as defined in the resource. For a link with a @Usage of "Output" , specifies the amount of the resource that is to be produced by the process, in units as defined in the resource. Allows resources to be only partially consumed or produced (see ▶ Section 3.10.4 Resource Amount). If not specified, ResourceLink/@Amount defaults to Resource/@Amount . Note: In JDF 1.5 @Amount was moved from the deleted abstract PhysicalLink .
DraftOK ? Deprecated in JDF 1.3	boolean	If "true" , the process can commence with a draft resource partition. Replaced with @MinLateStatus and @MinStatus in JDF 1.3 and beyond.
Duration ? Modified in JDF 1.4	duration	Estimated duration during which the resource will be used. Note: In JDF 1.4 @Duration was moved from ImplementationLink , which was deleted in JDF 1.5.

Table 3.16: PartAmount Element (Sheet 2 of 3)

NAME	DATA TYPE	DESCRIPTION
MaxAmount ? New in JDF 1.3	double	Defines the planned @Amount including the maximum overage. If not specified, defaults to a system specified value based on @Amount . Note: In JDF 1.5 @MaxAmount was moved from the deleted abstract PhysicalLink .
MinAmount ? New in JDF 1.3	double	Defines the planned @Amount including the maximum underage that the customer is willing to accept. If not specified, defaults to a system specified value based on @Amount . Note: In JDF 1.4 @MinAmount was moved from the deleted abstract PhysicalLink .
MinLateStatus ? New in JDF 1.3	enumeration	Minimum value of Resource/@Status for the execution of this node to commence when deadlines are endangered (i.e., when the time defined by NodeInfo/@LastStart or implied by NodeInfo/@LastEnd is approaching). Default value is from: @MinStatus . Allowed values are from: ▶ ResourceStatus.
MinStatus ? New in JDF 1.3	enumeration	Minimum value of Resource/@Status for the execution of this node to commence. Default value is: "Available" if @Usage="Input" and "Unavailable" if @Usage = "Output" . Allowed values are from: ▶ ResourceStatus.
Orientation ? New in JDF 1.1	enumeration	Named orientation describing the transformation of the orientation of a PhysicalResource relative to the ideal process coordinate that uses this resource as input or output. If @Orientation is specified for an output resource, the node that processes the PhysicalResource is to manipulate the resource in such a way as to reflect the transformation. The coordinate system of the resource itself is <i>not</i> modified. At most one of @Orientation or @Transformation SHALL be specified. For details on coordinate systems, see ▶ Section 2.6 Coordinate Systems in JDF. Note: In JDF 1.5 @Orientation was moved from the deleted abstract PhysicalLink . Allowed values are from: ▶ Orientation.
PipePause ?	double	Parameter for controlling the pausing of a process if the resource amount in the pipe buffer passes the specified value. For details on using @PipePause , see ▶ Section 4.3.3 Overlapping processing Using Pipes. Note: In JDF 1.5 @PipePause was moved from the deleted abstract PhysicalLink .
PipeResume ?	double	Parameter for controlling the resumption of a process if the resource amount in the pipe buffer passes the specified value. For details on using @PipeResume , see ▶ Section 4.3.3 Overlapping processing Using Pipes. Note: In JDF 1.5 @PipeResume was moved from the deleted abstract PhysicalLink .
PipeURL ?	URL	Pipe request URL for this partition. Dynamic pipe requests from this end of a pipe SHOULD be made to this URL. Note that this URL is only used for initiating pipe requests. Responses to a pipe request are issued to the URL that is defined in the PipePush or PipePull Message. For details on using @PipeURL , see ▶ Section 4.3.3 Overlapping processing Using Pipes. Note: In most cases @PipeURL is the URL of the controller of the <i>other end</i> of the pipe. This might seem counterintuitive, but it allows parallel spawning and merging of processes that represent a dynamic pipe without having to include the node that describes the other end in the spawned file.
RemotePipeEndPause ? Deprecated in JDF 1.5	double	Parameter for controlling the pausing of a process at the other end of the pipe if the resource amount in the pipe buffer passes the specified value. For details on using @RemotePipeEndPause , see ▶ Section 4.3.3 Overlapping processing Using Pipes. Note: In JDF 1.5 @RemotePipeEndPause was moved from the deleted abstract PhysicalLink . Deprecation note: Starting with JDF 1.5, use @PipePause .

Table 3.16: PartAmount Element (Sheet 3 of 3)

NAME	DATA TYPE	DESCRIPTION
<i>RemotePipeEndResume</i> ? Deprecated in JDF 1.5	double	Parameter for controlling the resumption of a process at the other end of the pipe if the resource amount in the pipe buffer passes the specified value. For details on using <i>@RemotePipeEndResume</i> , see ▶ Section 4.3.3 Overlapping processing Using Pipes. Note: In JDF 1.5 <i>@RemotePipeEndResume</i> was moved from the deleted abstract <i>PhysicalLink</i> . Deprecation note: Starting with JDF 1.5, use <i>@PipeResume</i> .
<i>Start</i> ? Modified in JDF 1.4	dateTime	Time and date when the usage of the resource starts. Note: In JDF 1.4 <i>@Start</i> was moved from the abstract <i>ImplementationLink</i> , which was deleted in JDF 1.5.
<i>StartOffset</i> ? Modified in JDF 1.4	duration	Offset time when the resource is needed after processing has begun. If both <i>@Start</i> and <i>@StartOffset</i> are specified, <i>@Start</i> has precedence. Note: In JDF 1.4 <i>@StartOffset</i> was moved from the abstract <i>ImplementationLink</i> , which was deleted in JDF 1.5.
<i>Transformation</i> ? New in JDF 1.1	matrix	Matrix describing the transformation of the orientation of a <i>PhysicalResource</i> relative to the ideal process coordinate using this resource as input or output. If <i>@Transformation</i> is specified for an output resource, the node that processes the <i>PhysicalResource</i> is to manipulate the resource in such a way as to reflect the transformation. The coordinate system of the resource itself is <i>not</i> modified. At most one of <i>@Orientation</i> or <i>@Transformation</i> SHALL be specified. For details on coordinate systems, see ▶ Section 2.6 Coordinate Systems in JDF. Note: In JDF 1.5 <i>@Transformation</i> was moved from the deleted abstract <i>PhysicalLink</i> .
<i>Lot</i> * New in JDF 1.3 Deprecated in JDF 1.6	element	Group of identifiers that uniquely identifies one lot of a resource. If multiple resource lots are planned to be consumed by a process, this element MAY appear multiple times to identify each resource lot. Examples of resource lots are individual rolls of paper, boxes of paper, cans of ink, etc. See ▶ Section 3.9.4 Identification of Physical Resources for details. For resources that are solely identified by <i>@ProductID</i> , <i>Lot</i> element(s) NEED NOT be specified. Note: In JDF 1.5 <i>@Lot</i> was moved from the deleted abstract <i>PhysicalLink</i> .
<i>Part</i> + Modified in JDF 1.3	element	Specifies the selected parts that the <i>PartAmount</i> is valid for. The granularity of <i>Part</i> SHALL be at least that of a leaf partition of the <i>Resource</i> . For instance, a <i>Component</i> MAY be partitioned by <i>@SheetName</i> and <i>PartAmount</i> could refer to <i>@SheetName</i> and <i>@Condition</i> . Multiple <i>Part</i> elements specify that the referenced elements have been processed in one step, for instance two separations on a press run of a two color press.

Example 3.6: PartAmount

The following example shows an [InkLink](#) with an [AmountPool](#).

```
<ResourcePool>
  <Ink Brand="NoName" Class="Consumable" ID="Link0015"
    PartIDKeys="Separation" Status="Available">
    <Ink ColorName="Cyan" Separation="Cyan"/>
    <Ink ColorName="Magenta" Separation="Magenta"/>
    <Ink ColorName="Yellow" Separation="Yellow"/>
    <Ink ColorName="Black" Separation="Black"/>
    <Ink ColorName="Heidelberg Spot Blau" Separation="Heidelberg Spot Blau"/>
  </Ink>
</ResourcePool>
<ResourceLinkPool>
  <InkLink Usage="Input" rRef="Link0015">
    <AmountPool>
      <PartAmount Amount="1000">
        <Part Separation="Cyan"/>
      </PartAmount>
      <PartAmount Amount="1200">
        <Part Separation="Magenta"/>
      </PartAmount>
      <PartAmount Amount="700">
        <Part Separation="Yellow"/>
      </PartAmount>
      <PartAmount Amount="3000">
        <Part Separation="Black"/>
      </PartAmount>
      <PartAmount Amount="300">
        <Part Separation="Heidelberg Spot Blau"/>
      </PartAmount>
    </AmountPool>
  </InkLink>
</ResourceLinkPool>
```

3.9.4 Identification of Physical Resources

New in JDF 1.3

MIS systems frequently include functionality for managing inventory. Many [PhysicalResources](#) that are consumed by production processes are things that are tracked for inventory management purposes. This allows estimating the value of the resources, ensuring that sufficient quantities are on hand, and tracking which specific resources are used in production of which jobs. At the most basic level, these [PhysicalResources](#) MAY be identified in **JDF** with [Resource/@ProductID](#).

Some MIS systems track these resources at lower levels of detail, tracking individual resource lots. An example of this might include tracking the individual rolls or boxes of paper. While it is theoretically possible to track individual resource lots using a single identifier, many MIS users choose to track them with more than one identifier. Examples of some of these identifiers include roll numbers, lot numbers, purchase order numbers, receipt dates.

Because the required identifiers may be different from site to site, or even from one type resource to another, it is not possible to track these resources with multiple identifiers using **JDF**. Conveying the identification requirements to devices would be too complex. Instead, a single identifier is used in **JDF**. In cases where multiple identifiers are normally used, the MIS SHALL generate a unique identifier for each unique resource lot. This unique identifier SHALL then be mapped back to the correct unique resource lot by the MIS.

3.9.4.0.1 Lot

Deprecated in JDF 1.6

3.10 ResourcePool and ResourceLinkPool – Deep Structure

This section describes the deep structure of a [ResourcePool](#) and [ResourceLinkPool](#). In particular, this section describes the [ResourceRef](#) which references a resource from within another resource. This section also describes resource sets and the partitioning of them.

3.10.1 ResourceElement – Subelement of a Resource

3.10.1.1 ResourceElement

A **ResourceElement** is always a subelement of a resource or subelement of a **JMF** message

3.10.1.2 Abstract ResourceElement

An **Abstract ResourceElement** is defined in the ▶ Table 3.17 Abstract ResourceElement below. A **ResourceElement** does not inherit from the **Abstract Resource**. Examples of **ResourceElement** resources are **SeparationSpec** and **MISDetails**.

Table 3.17: Abstract ResourceElement

NAME	DATA TYPE	DESCRIPTION
<i>ID</i> ? Deprecated in JDF 1.2	ID	Unique identifier of a Resource element. In JDF 1.2 and beyond, an element that is not a direct child of a ResourcePool SHOULD NOT contain an @ID . This @ID SHALL NOT be referenced by ResourceRef/@rRef or ResourceLink/@rRef because a ResourceRef or ResourceLink element is able to reference a Resource only if it is a direct child of a ResourcePool .

3.10.2 ResourceRef – Element for Inter-Resource Linking and refelement

3.10.2.1 ResourceRef

In some cases, it is necessary to reference a **Resource** element directly from another element in order to reuse information. Such a reference is a **ResourceRef** element. A **ResourceRef** element's name is generated by appending the string "Ref" to the element's name. Candidate elements for inter-Resource linking have a data type of refelement in the content description tables of this chapter and ▶ Chapter 8 Resources. A data type of **refelement** allows either a **ResourceRef** or an inline **Resource** element. In the latter case, the **Resource** element inherits attributes and elements from the **Abstract Resource** and (where appropriate) from the **Abstract Parameter Resource** or the **Abstract PhysicalResource**. Note that some attributes and elements in these abstract elements have rules for inline resource subelements that differ from the rules for a resource root.

3.10.2.2 Abstract ResourceRef

The following table defines the attributes of the **Abstract ResourceRef** element (see also ▶ Figure 3-5: ResourcePool and abstract resource element structure and **ResourceElement** in ▶ Table 3.8 Abstract Resource Element).

The **Part** element in a **ResourceRef** defines the part of the target that this **ResourceRef** references. If both the **Resource** that contains **ResourceRef** element and the target **Resource** are partitioned, the **ResourceRef** does not implicitly reference the part of the target with the same partitioning attributes, but rather the parts of the target **Resource** that are explicitly specified by the **Part** element within the **ResourceRef**.

When a **ResourceRef** references a partitioned resource node that is not a resource leaf, the children of the referenced resource are ignored. See ▶ Example 70 MediaRef to Partitioned Media and ▶ Example 70 Equivalent Inline Media for an illustration of this equivalence. Otherwise, the referenced structure would be a partitioned element and thus invalid when inlined. See ▶ Example 70 Invalid Inline Partitioned Media.

Table 3.18: Abstract ResourceRef Element

NAME	DATA TYPE	DESCRIPTION
<i>rRef</i>	IDREF	Reference to the resource. The linked resource SHALL be a direct child of a ResourcePool .
<i>rSubRef</i> ? Deprecated in JDF 1.2	IDREF	Reference to a subelement of the Resource . In JDF 1.2 and beyond, a ResourceRef element is able to reference a Resource only if it is a direct child of a ResourcePool
Part ? New in JDF 1.1	element	Definition of the partition that this ResourceRef references.

Example 3.7: MediaRef to Partitioned Media

MediaRef references **Media** and its children are ignored:

```
<Media Class="Consumable" Dimension="72 72" ID="MediaID"
  PartIDKeys="Location" Status="Available">
  <Comment Name="foo">bar</Comment>
  <Media Location="desk"/>
  <Media Location="drawer"/>
</Media>
<Layout Class="Parameter" ID="Sheet" Status="Available">
  <MediaRef rRef="MediaID"/>
</Layout>
```

Example 3.8: Equivalent Inline Media

Media is inline in **Layout**. This is equivalent to the preceding ▶ Example 70 MediaRef to Partitioned Media with **MediaRef**:

```
<Layout Class="Parameter" ID="Sheet" Status="Available">
  <Media Dimension="72 72">
    <Comment Name="foo">bar</Comment>
  </Media>
</Layout>
```

Example 3.9: Invalid Inline Partitioned Media

This example takes the **Media** from ▶ Example 70 MediaRef to Partitioned Media and make it be inline in **Layout**. The result is an invalid partition:

```
<Layout Class="Parameter" ID="Sheet" Status="Available">
  <Media Dimension="72 72" PartIDKeys="Location">
    <Comment Name="foo">bar</Comment>
    <Media Location="desk"/>
    <Media Location="drawer"/>
  </Media>
</Layout>
```

3.10.2.3 ResourceRef Elements in the AncestorPool/Ancestor Element

ResourceRef elements MAY also occur in the **AmountPool/PartAmount** element of a **JDF** node. Resources that are referenced SHALL reside in a **ResourcePool**. The restrictions on locations of resource elements described in ▶ Section 3.8.6 Position of Resources within JDF Nodes that apply to **ResourceLink** elements similarly apply to **ResourceRef** elements.

3.10.2.4 Status of a Resource that Contains an rRef Reference

The **@Status** of a resource that contains an **@rRef** attribute is defined by the lowest **@Status** of all recursively referenced resources. The ordering is defined in ▶ Table 3.8 Abstract Resource Element:

Thus, if any referenced resource has a **@Status** of "Incomplete", the complete resource has a calculated **@Status** of "Incomplete", even though its own **@Status** attribute might be "Unavailable", "Draft", "Available", etc.

3.10.2.5 Alignment of ResourceLink and ResourceRef

New in JDF 1.1A

ResourceRef elements SHALL NOT contain any of the attributes and elements that are specified in the **ResourceLink** as defined in ▶ Section 3.9 ResourceLinkPool and ResourceLink. The value of these properties is implied from the value of the properties for the appropriate part in the **AmountPool** of the **ResourceLink**.

Example 3.10: MediaLink and MediaRef

The following example illustrates the alignment of a **MediaLink** and **MediaRef** in a **DigitalPrinting** node.

```
<JDF ID="n20020626134204" JobPartID="ID345" Status="Waiting"
  Type="DigitalPrinting" Version="1.6" xmlns="http://www.CIP4.org/JDFSchema_1_1">
  <ResourcePool>
    <!-- Media is partitioned so that it can be referenced
      from the AmountPool
    -->
    <Media Class="Consumable" ID="r0006" PartIDKeys="RunIndex" Status="Available">
      <Media RunIndex="0 -1"/>
      <Media RunIndex="1 ~ -2"/>
    </Media>
    <DigitalPrintingParams Class="Parameter" ID="r0007"
      PartIDKeys="RunIndex" Status="Available">
      <DigitalPrintingParams RunIndex="0 -1">
        <!-- PartAmount with <Part RunIndex="0 -1"/> contains
          the partition details for this MediaRef -->
        <MediaRef rRef="r0006">
          <Part RunIndex="0 -1"/>
        </MediaRef>
      </DigitalPrintingParams>
      <DigitalPrintingParams RunIndex="1 ~ -2">
        <!-- PartAmount with <Part RunIndex="1 ~ -2"/>
          contains the partition details for this MediaRef
        -->
        <MediaRef rRef="r0006">
          <Part RunIndex="1 ~ -2"/>
        </MediaRef>
      </DigitalPrintingParams>
    </DigitalPrintingParams>
    <RunList Class="Parameter" ID="r0008" Status="Available"/>
    <Component Class="Quantity" ComponentType="Sheet" ID="c0008" Status="Unavailable"/>
  </ResourcePool>
  <ResourceLinkPool>
    <MediaLink Usage="Input" rRef="r0006">
      <!-- the AmountPool contains the ResourceLink partition details -->
      <AmountPool>
        <PartAmount Orientation="Flip180">
          <Part RunIndex="0 -1"/>
        </PartAmount>
        <PartAmount Orientation="Rotate0">
          <Part RunIndex="1 ~ -2"/>
        </PartAmount>
      </AmountPool>
    </MediaLink>
    <DigitalPrintingParamsLink Usage="Input" rRef="r0007"/>
    <RunListLink Usage="Input" rRef="r0008"/>
    <ComponentLink Usage="Output" rRef="c0008"/>
  </ResourceLinkPool>
</JDF>
```

3.10.3 Set of Resources and Partitioned Subsets Thereof

In many cases, a set of similar resources—such as separation films, plates or **RunList** resources—is produced by one process and consumed by another. When this occurs, it is convenient to define one resource element that describes the complete set and allows individual subsets to be referenced. This mechanism also removes process ambiguity if multiple input **ResourceLink** elements and multiple output **ResourceLink** elements exist that are to be unambiguously correlated.

In other cases, there can be a need to change some attribute of a **Parameter Resource** for some subset of the processing to be done by a device. For instance, when printing a document using **DigitalPrinting**, it would be a common application to change the dimensions of the media to be selected based on the actual media box changes in a PDF file.

Resource elements and **ResourceLink** elements have OPTIONAL attributes that enable an agent to specify an explicit part of a structured resource. There are two ways to reference a subset of a resource. The first is by quantity (i.e., by specifying an amount in a **ResourceLink** that is less than the resource's amount). The second is to select certain parts of a partitioned resource by supplying a filtering **Part** element in the **ResourceLink**.

3.10.4 Resource Amount

Yet another flexible feature of resources is that they can be only partially consumed. For example, in a scenario in which various versions of a product share identical parts—such as versioned books that all have the same cover—each version will only use as many copies of the cover as it needs to fulfill its job requirement, even though all of the covers can be printed in one step for all versions. This feature is specified in the `@Amount` attribute of the `ResourceLink` elements and allows multiple **JDF** nodes to share resources. It allows both the sharing of output resources (when a binding process consumes identical sheets from multiple press lines) and the sharing of input resources (when the covers for multiple jobs are identical and are all printed in one press run).

The `@Amount` attribute of a `PhysicalResource` element contains the actual amount of a given resource. It is adjusted by the production or consumption amount of every process that is executed and refers to that amount in the corresponding `ResourceLink` element. Thus the value of the `@Amount` attribute of a resource that is consumed as an input SHOULD be reduced by the amount that is consumed. It is up to the agent that writes a **JDF** job to ensure that the `@Amount` attributes of resources and the `ResourceLink` elements that reference them are consistent. The units used in the `@Amount` attribute of a `ResourceLink` element is defined by the unit of the resource element to which the link refers. The definition of `@Amount` for partitioned resources is explained in detail in ▶ Section 3.10.5 Description of Partitioned Resources.

Note that for resources which are the output of processes, the `@Amount` attribute on the `ResourceLink` determines the quantity of the resource to be produced. For example, in a **DigitalPrinting** process that included a `RunList` as its input with 16 pages to be printed and a `ComponentLink` to its output, the `@Amount` and `@AmountProduced` attributes would indicate the number of copies of those 16 pages that the process would produce.

`NodeInfoLink/@Amount` and `NodeInfoLink/AmountPool/PartAmount/@Amount` describe the amount to be produced in general. This amount describes the number of products to be produced. For instance, on a conventional sheet-fed offset press, this would be press runs, and on a saddle stitcher it would be finished brochures.

3.10.4.1 Evaluating and Updating Amount-Related Attributes in a Device

`ResourceLink/@Amount` specifies the planned amount whereas `ResourceLink/@ActualAmount` specifies the actual production amount. When a device executes a **JDF** node that consumes and produces `PhysicalResources` with an amount, it SHALL calculate the needed production amount in the following order: $\text{Production Amount}(\text{Output}) =$

- 1 `NodeInfoLink/AmountPool/PartAmount/@Amount - NodeInfoLink/AmountPool/PartAmount/@ActualAmount`
- 2 `NodeInfoLink/@Amount - NodeInfoLink/@ActualAmount`
- 3 `ComponentLink("Output")/AmountPool/PartAmount/@Amount - ComponentLink("Output")/AmountPool/PartAmount/@ActualAmount`
- 4 `ComponentLink("Output")/@Amount - ComponentLink("Output")/@ActualAmount`
- 5 `Component("Output")/@Amount - ComponentLink("Output")/@ActualAmount`
- 6 `ResourceLink("Input")/AmountPool/PartAmount/@Amount - ResourceLink("Input")/AmountPool/PartAmount/@ActualAmount`
- 7 `ResourceLink("Input")/@Amount - ResourceLink("Input")/@ActualAmount`
- 8 `PhysicalResource("Input")/@Amount - ResourceLink("Input")/@ActualAmount`
- 9 Implied amount from consuming the complete input resource.

It is strongly RECOMMENDED for MIS systems to explicitly specify the desired production amount of a process by specifying `ComponentLink("Output")/@Amount` or `ComponentLink("Output")/AmountPool/PartAmount/@Amount` in case of partitioned resources. The device SHOULD increment `ResourceLink/@ActualAmount` or `ResourceLink/AmountPool/PartAmount/@ActualAmount` by the amount of actual consumption and production. An MIS system that receives a completed process from a device SHALL update `Resource/@Amount` by summing over all `ResourceLink` elements that are linked from leaf nodes:

`ComponentLink("Output")/AmountPool/PartAmount/@Amount`
 - `ComponentLink("Output")/AmountPool/PartAmount/@ActualAmount`

OR

`ComponentLink("Output")/@Amount - ComponentLink("Output")/@ActualAmount`
 and subtracting all links that are linked from leaf nodes:

`ComponentLink("Input")/AmountPool/PartAmount/@Amount`
 - `ComponentLink("Input")/AmountPool/PartAmount/@ActualAmount`

OR

`ComponentLink("Output")/@Amount - ComponentLink("Input")/@ActualAmount`

ComponentLink elements from intermediate nodes ("ProcessGroup" or "Product") SHALL be ignored when summing, since they redundantly link to the same resources without specifying any additional production amount.

3.10.4.2 Specifying Amount for a Partially-Completed Process

New in JDF 1.2

A process can be interrupted before the requested amount of output has been produced. When the job is re-submitted from the controller to the device, it SHALL produce only the remaining @Amount. The following figure shows the various processes, resources and ResourceLink elements and their corresponding entries in Table 3.19 Example of actual amount and amount handling which summarizes the values of the @Amount, @AmountProduced and @AmountRequired attributes in the Component, the @Amount and @ActualAmount of ComponentLink in various steps of the process. All planned amounts are multiples of 1000, whereas all actual amounts are randomly adjusted for waste and production overrun or underrun.

Figure 3-9: Amount handling

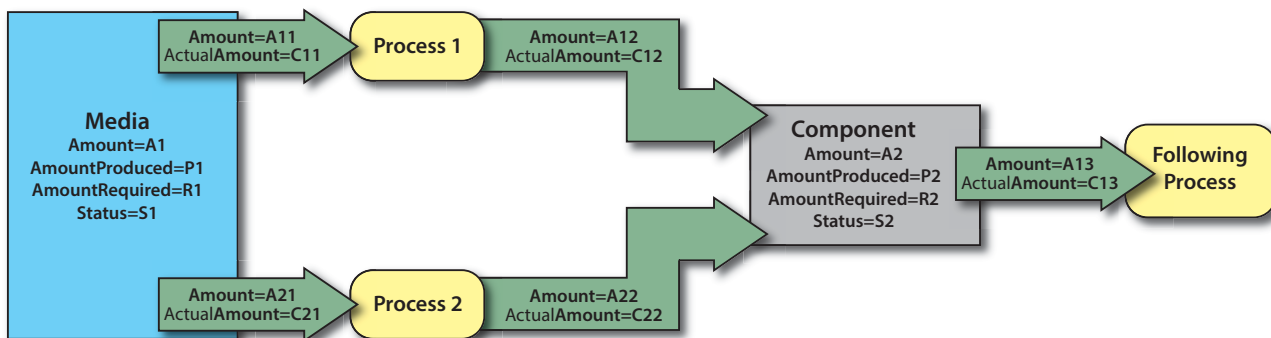

Table 3.19: Example of actual amount and amount handling (Sheet 1 of 2)

PROCESS STEP	A1 P1 R1 S1	A11 C11 A21 C21	A12 C12 A22 C22	A2 P2 R2 S2	A13 C13
Original JDF, no processing has commenced. A large Amount of Media (500000) is available. Plan 10% waste. The following Processes are not yet setup.	500000 — 110000 Available	110000 0 — —	100000 0 — —	0 0 — Unavailable	— — — —
Break after producing exactly 30,000 good copies. Actual waste = 2957	467043 — 110000 Available	110000 32957 — —	100000 30000 — —	30000 30000 — Available	— — — —
Break after producing exactly an additional 40,000 copies Accumulated actual waste = 6545	423455 — 110000 Available	110000 76545 — —	100000 70000 — —	70000 70000 — Available	— — — —
Completed Overrun = 1234 Accumulated actual waste = 9323	390677 — 110000 Available	110000 109323 — —	100000 101234 — —	101234 101234 — Available	— — — —

Consumption of the output by a subsequent process

Table 3.19: Example of actual amount and amount handling (Sheet 2 of 2)

PROCESS STEP	A1 P1 R1 S1	A11 C11	A12 C12	A2 P2 R2 S2	A13 C13
		A21 C21	A22 C22		
A following Process consumes 50,010 copies	390677 — 110000 Available	110000 109323 — —	100000 101234 — —	51224 101234 50000 Available	50000 50010
Additional Copy Request					
A total of 120,000 copies are requested	390677 — 110000 Available	132000 109323 — —	120000 101234 — —	51224 101234 50000 Available	50000 50010
The 20,000 copies are produced(- underrun) Accumulated actual waste = 12123	367877 — 132000 Available	132000 132123 — —	120000 119999 — —	69989 119999 50000 Available	50000 50010
Parallel Production by a second Device					
30,000 additional copies of the same Resource are requested from a different Device. 20% waste is assumed	367877 — 168000 Available	132000 132123 36000 0	120000 119999 30000 0	69989 119999 50000 Available	50000 50010
The 30,000 copies are produced	331856 — 168000 Available	132000 132123 36000 36021	120000 119999 30000 30100	100089 150099 50000 Available	50000 50010
Consumption by the following process					
The Consuming Node is set up to consume all available Components	331856 — 168000 Available	132000 132123 36000 36021	120000 119999 30000 30100	100089 150099 50000 Available	150000 50010
All intermediate copies are consumed	331856 — 168000 Available	132000 132123 36000 36021	120000 119999 30000 30100	0 150099 150000 Unavailable	150000 150099

3.10.5 Description of Partitioned Resources

Printing workflows contain a number of processes that are repeated over a potentially large number of individual files, sheets, surfaces or separations. In order to define a partitioned resource in a concise manner without having to create a large number of individual nodes and resources, a set of resources might be partitioned by factoring them by one or more attributes. The common elements and defaults are placed in the parent element, while partition-specific attributes and

overrides are placed in the child elements. This saves space. In addition, by providing a single parent ID for the resources, it allows easy access to the entire resource or iteration over each part.

To reference part of a resource, a **ResourceLink** references the parent resource and supplies a **Part** element that contains an actual value for a partition. The result is all the child elements with matching partition values, including common values and defaults from the parent resource. If `@PartUsage = "Implicit"`, the parent attributes are returned if there is no matching partition.

A partitioned resource MAY contain nested elements, each with the same name as the partitioned resource root. The part-independent resource elements and attributes are located in the root of the resource, while the partition-dependent elements are located in the nested elements. Thus one individual part is defined by the convolution of the partition-independent elements and attributes, with the elements and attributes contained in the appropriate nested elements. The attributes of nested part elements are overwritten by the equivalent attributes in descendent elements.

Some processes will enumerate a resource in XML order by using partition key values which it generates and modifies as part of its processing. Other processes will treat the resource as a random access resource and look up leaf nodes based on the current settings of `@PartIDKeys` values. For example, the **RunList** resource can be used by the **Imposition** process to define key values (such as the `@Run` partition key during consumption of the **RunList**, and the **Layout** resource uses partitioning to define a set of templates chosen based on the current content from the **RunList** being processed.

3.10.5.1 Subelements in Partitioned Resources

Subelements of a partitioned resource are inherited by a descendent element if and only if no equivalent subelements exist in the descendent element. Subelements are completely replaced by those in descendent elements even if cardinality of the subelement allows multiple occurrences.

Example 3.11: Inheritance for Subelements of a Partitioned Resource

For example, the following **SeparationSpec** is two color duo-tone (only "Black" and SpotGreen) in the part with `@PageNumber = "1"`. For additional examples and restrictions, see also ▶ Section 8.84.17.1.2 Position of PlacedObject Elements in Layout which contains ▶ Example 481 Invalid MarkObject and ▶ Example 482 MarkObject.

```
<LayoutElement Class="Parameter" ID="ID1" PartIDKeys="PageNumber" Status="Available">
  <SeparationSpec Name="Cyan"/>
  <SeparationSpec Name="Magenta"/>
  <SeparationSpec Name="Yellow"/>
  <SeparationSpec Name="Black"/>
  <FileSpec/>
  <LayoutElement PageNumber="0"/>
  <LayoutElement PageNumber="1">
    <!-- These two SeparationSpec Elements completely replace the
         CMYK in the root
    -->
    <SeparationSpec Name="Black"/>
    <SeparationSpec Name="SpotGreen"/>
  </LayoutElement>
</LayoutElement>
```

3.10.5.2 Amount in Partitioned Resources

New in JDF 1.2

The `@Amount` attribute of a partitioned resource is treated formally exactly in the same manner as any other attribute. This implies that the amount specified refers to the amount defined by one leaf, and not to the amount defined by the sum of leaves in a branch. The `@Amount` attribute defined in the example below is, therefore, two, even though 24 physical plates are described.

Example 3.12: Partitioned ExposedMedia

The following example defines two sets of 12 plates for two sheets with three surfaces. Each has a common brand attribute called "Gooley". Each individual separation has its own `@ProductID`. Furthermore, the `Status` attribute varies from

STRUCTURE

part to part. For example, if a yellow plate breaks, only it will need to be remade and, therefore, set to "Unavailable"; the others, meanwhile, can remain "Available".

```
<ExposedMedia Amount="2" Brand="Goocy" Class="Handling" ID="L1"
  PartIDKeys="SheetName Side Separation" Status="Available">
  <Media Dimension="500 600" MediaType="Plate"/>
  <ExposedMedia SheetName="S1">
    <ExposedMedia Side="Front">
      <ExposedMedia ProductID="S1FCPlateJ42" Separation="Cyan"/>
      <ExposedMedia ProductID="S1FMPlateJ42" Separation="Magenta"/>
      <ExposedMedia ProductID="S1FYPlateJ42" Separation="Yellow" Status="Unavailable"/>
      <ExposedMedia ProductID="S1FKPlateJ42" Separation="Black"/>
    </ExposedMedia>
    <ExposedMedia Side="Back">
      <ExposedMedia ProductID="S1BCPlateJ42" Separation="Cyan"/>
      <ExposedMedia ProductID="S1BMPlateJ42" Separation="Magenta"/>
      <ExposedMedia ProductID="S1BYPlateJ42" Separation="Yellow"/>
      <ExposedMedia ProductID="S1BKPlateJ42" Separation="Black"/>
    </ExposedMedia>
  </ExposedMedia>
  <ExposedMedia SheetName="S2">
    <ExposedMedia Side="Front">
      <ExposedMedia ProductID="S2FCPlateJ42" Separation="Cyan"/>
      <ExposedMedia ProductID="S2FMPlateJ42" Separation="Magenta"/>
      <ExposedMedia ProductID="S2FYPlateJ42" Separation="Yellow"/>
      <ExposedMedia ProductID="S2FKPlateJ42" Separation="Black"/>
    </ExposedMedia>
  </ExposedMedia>
</ExposedMedia>
```

3.10.5.3 Relating PartIDKeys and Partitions

New in JDF 1.2

The `@PartIDKeys` attribute (see ▶ Section 3.10.6 PartIDKeys Attribute and Partition Keys) describes the partition keys that occur in a partitioned resource. The sequence and number of keys is restricted in order and cardinality to ensure interoperability. The first entry in the `@PartIDKeys` list defines the partition closest to the root, the next entry defines the next intermediate partition node and so forth until the last entry, which defines the partition leaves. Each partition key SHALL occur exactly once in the `@PartIDKeys` list. Note that some of the restrictions specified in this section were assumed to be in place in versions before **JDF 1.2** but were not explicitly stated in the specification.

The value of each partition key SHALL be unique in the scope of a single resource. Thus two resource siblings SHALL NOT contain a partition key with the same name and value.

3.10.5.3.1 Incomplete Partitions

New in JDF 1.2

Partitioned resources MAY be partitioned by a restricted subset of keys in the `@PartIDKeys` list. Keys from the back of the list MAY be omitted in individual partitions. If a key is omitted, all subsequent keys SHALL also be omitted.

Example 3.13: Legal Incomplete Partition

The following example demonstrates a legal incomplete partition. It is incomplete because the `Preview` that is partitioned by `@PreviewType = "ThumbNail"` is not also partitioned by `@Separation`. It is legal because the omitted key `@Separation` is at the end of the `@PartIDKeys` list:

```
<Preview Class="Parameter" ID="P1"
  PartIDKeys="PreviewType Separation" Status="Available" URL="File:///aaa.pdf">
  <Preview PreviewType="Separation">
    <Preview Separation="Cyan"/>
    <Preview Separation="Magenta"/>
  </Preview>
  <Preview PreviewType="ThumbNail"/>
</Preview>
```

Example 3.14: Illegal Incomplete Partition

The following example demonstrates an illegal incomplete partition; in this particular case, the omitted keys are not at the end of the `@PartIDKeys` list:

```
<Preview Class="Parameter" ID="P2"
  PartIDKeys="PreviewType Separation" Status="Available">
  <Preview Separation="Cyan"/>
  <Preview Separation="Magenta"/>
</Preview>
```

3.10.5.3.2 Number of Partition Keys per Partitioned Leaf or Node

New in JDF 1.2

Exactly one partition key SHALL be specified per leaf or node, excluding the root node.

Note: This allows XPath-type searches on partitioned leaves.

Example 3.15: Legal Complete Partition

The following example demonstrates a legal partition:

```
<Preview Class="Parameter" ID="P3"
  PartIDKeys="PreviewType Separation" Status="Available" URL="File:///aaa.pdf">
  <Preview PreviewType="Separation">
    <Preview Separation="Cyan"/>
  </Preview>
</Preview>
```

Example 3.16: Illegal Partition

The following example demonstrates an illegal partition since more than one partition key is specified in the leaf, namely, `@PreviewType` and `@Separation`:

```
<Preview Class="Parameter" ID="P4"
  PartIDKeys="PreviewType Separation" Status="Available" URL="File:///aaa.pdf">
  <Preview PreviewType="Separation" Separation="Cyan"/>
</Preview>
```

3.10.5.3.3 Degenerate Partitions

New in JDF 1.2

A partitioned resource SHALL NOT contain partition keys in the root. Mapping partitioned parameters to non-Partitioned resources is achieved by partitioning the resource with exactly one leaf.

Example 3.17: Degenerate Partition

The following example specifies that only "c1" be folded:

```
<Component Class="Quantity" ComponentType="Sheet" ID="c1"
  PartIDKeys="SheetName" Status="Available">
  <Component SheetName="Sheet 1"/>
</Component>
<Component Class="Quantity" ComponentType="Sheet" ID="c2"
  PartIDKeys="SheetName" Status="Available">
  <Component SheetName="Sheet 2"/>
</Component>
<FoldingParams Class="Parameter" ID="fold" NoOp="true"
  PartIDKeys="SheetName" Status="Available">
  <FoldingParams NoOp="false" SheetName="Sheet 1"/>
</FoldingParams>
```

Example 3.18: Invalid Degenerate Partition

The **Component** elements in the following example are NOT valid:

```
<Component Class="Quantity" ComponentType="Sheet" ID="c12"
  PartIDKeys="SheetName" SheetName="Sheet 1" Status="Available"/>
<Component Class="Quantity" ComponentType="Sheet" ID="c22"
  PartIDKeys="SheetName" SheetName="Sheet 2" Status="Available"/>
<FoldingParams Class="Parameter" ID="fold2" NoOp="true"
  PartIDKeys="SheetName" Status="Available">
  <FoldingParams NoOp="false"/>
</FoldingParams>
```

3.10.5.4 Partitioning of Resource Subelements**New in JDF 1.2**

Only resources can be partitioned. If a resource contains subelements, the subelements SHALL NOT be partitioned. Subelements SHALL always be specified completely in that part in which they occur. The content of subelements is not convoluted with the content of subelements in parts closer to the root. Five examples are provided below. While the first and fourth examples are valid, the second, third and fifth are invalid.

Example 3.19: Partitioned ExposedMedia with Media Subelements

In the first example, the **ExposedMedia** resource is partitioned.

```
<ExposedMedia Class="Handling" ID="L1" PartIDKeys="Separation" Status="Available">
  <Media Brand="foo" MediaType="Film"/>
  <ExposedMedia Separation="Cyan"/>
  <ExposedMedia Separation="Magenta">
    <Media Brand="bar" MediaType="Film"/>
  </ExposedMedia>
</ExposedMedia>
```

Example 3.20: Partitioned ExposedMedia with Incomplete Media Subelements

In this incomplete example, the **Media** in the leaves is not complete because it does not contain the **@MediaType** attribute. **@MediaType** is not inherited from the **Media** element in the root resource because, in this case, **Media** is not the partitioned resource.

```
<ExposedMedia Class="Handling" ID="L21" PartIDKeys="Separation" Status="Available">
  <Media MediaType="Film"/>
  <ExposedMedia Separation="Cyan">
    <Media Brand="foo"/>
  </ExposedMedia>
  <ExposedMedia Separation="Magenta">
    <Media Brand="bar" Class="Consumable"/>
  </ExposedMedia>
</ExposedMedia>
```

Example 3.21: Partitioned ExposedMedia with Invalid Partitioning of Media Subelements

In this invalid example, **Media** is a subelement that SHALL NOT be partitioned.

```
<ExposedMedia Class="Handling" ID="L31" PartIDKeys="Separation" Status="Available">
  <Media MediaType="Film">
    <Media Brand="foo" Separation="Cyan"/>
    <Media Brand="bar" Separation="Magenta"/>
  </Media>
</ExposedMedia>
```

Example 3.22: Partitioned ExposedMedia with MediaRef Subelements

Partitioning MAY be combined with inter-Resource links (i.e., [ResourceRef](#) elements). In the following valid example, each [MediaRef](#) is equivalent to an in-lined leaf with the explicit [Part](#) elements to define the partition (i.e., it is equivalent to the valid ▶ Example 78 Partitioned ExposedMedia with Media Subelements).

```
<Media Class="Consumable" ID="MediaID" MediaType="Film"
  PartIDKeys="Separation" Status="Available">
  <Media Brand="foo" Separation="Cyan"/>
  <Media Brand="bar" Separation="Magenta"/>
</Media>
<ExposedMedia Class="Handling" ID="L41" PartIDKeys="Separation" Status="Available">
  <ExposedMedia Separation="Cyan">
    <!--equivalent to <Media MediaType="Film" Brand="foo"/> -->
    <MediaRef rRef="MediaID">
      <Part Separation="Cyan"/>
    </MediaRef>
  </ExposedMedia>
  <ExposedMedia Separation="Magenta">
    <!--equivalent to <Media MediaType="Film" Brand="bar"/> -->
    <MediaRef rRef="MediaID">
      <Part Separation="Magenta"/>
    </MediaRef>
  </ExposedMedia>
</ExposedMedia>
```

Example 3.23: Partitioned ExposedMedia with Invalid MediaRef Subelements

In this invalid example, [MediaRef](#) does not reference the leaves of media but, rather, to the root of [Media](#). It is equivalent to the invalid ▶ Example 78 Partitioned ExposedMedia with Invalid Partitioning of Media Subelements.

```
<Media Class="Consumable" ID="MediaID2" MediaType="Film"
  PartIDKeys="Separation" Status="Available">
  <Media Brand="foo" Separation="Cyan"/>
  <Media Brand="bar" Separation="Magenta"/>
</Media>
<ExposedMedia Class="Handling" ID="L51" PartIDKeys="Separation" Status="Available">
  <MediaRef rRef="MediaID2"/>
</ExposedMedia>
```

3.10.5.5 Logical Partitions and the Identical Element

New in JDF 1.3

Partitioning is a mechanism for describing a complete set of similar resources, but always leads to a tree structure of resources. Sometimes it is necessary to describe a set of resources that are not a tree, but where some partitions of the set are 'identical' to another partition. A set of [ExposedMedia](#) resources where the same plate for the separation 'CompanySpot' is reused for all sheets is a practical example.

3.10.5.5.1 Identical

Any partitioned resource MAY contain an [Identical](#) subelement. The resource partition containing the [Identical](#) element is called the logical partition or slave partition. Linking a logical partition using a [ResourceLink](#) or referencing a logical partition using a [ResourceRef](#) is semantically the same as linking/referencing the master partition.

All attributes except for the attributes specified in [@PartIDKeys](#) and all subelements of the resource (see ▶ Table 3.8 Abstract Resource Element) specified or inherited in the logical partition SHALL be ignored and replaced by the attributes and subelements of the master partition.

Table 3.20: Identical Element

NAME	DATA TYPE	DESCRIPTION
Part	element	Identifies the physical partition which will be used instead of the logical partition. The logical partition is defined by the resource partition containing the Identical element.

Example 3.24: Partitioning with the Identical Element

In the following example the back side of sheet S2 is identical to the back side of sheet S1:

```
<ExposedMedia Class="Handling" ID="L1"
PartIDKeys="SheetName Side Separation" Status="Available">
  <Media Class="Consumable" MediaType="Film"/>
  <ExposedMedia SheetName="S1">
    <ExposedMedia Side="Front">
      <ExposedMedia ProductID="1" Separation="Cyan"/>
      <ExposedMedia ProductID="2" Separation="Magenta"/>
      <ExposedMedia ProductID="3" Separation="Yellow"/>
      <ExposedMedia ProductID="4" Separation="Black"/>
    </ExposedMedia>
    <!-- Master partition that is referenced by an Identical Element -->
    <ExposedMedia Side="Back">
      <ExposedMedia ProductID="5" Separation="Cyan"/>
      <ExposedMedia ProductID="6" Separation="Magenta"/>
      <ExposedMedia ProductID="7" Separation="Yellow"/>
      <ExposedMedia ProductID="8" Separation="Black"/>
    </ExposedMedia>
  </ExposedMedia>
  <ExposedMedia SheetName="S2">
    <ExposedMedia Side="Front">
      <ExposedMedia ProductID="9" Separation="Cyan"/>
      <ExposedMedia ProductID="10" Separation="Magenta"/>
      <ExposedMedia ProductID="11" Separation="Yellow"/>
      <ExposedMedia ProductID="12" Separation="Black"/>
    </ExposedMedia>
    <!-- Logical partition with an Identical Element -->
    <ExposedMedia Side="Back">
      <Identical>
        <Part SheetName="S1" Side="Back"/>
      </Identical>
    </ExposedMedia>
  </ExposedMedia>
</ExposedMedia>
```

3.10.5.5.2 Restrictions when using Identical Elements

The **Identical** element SHALL contain exactly one **Part** subelement, which identifies the physical or master partition that is identical to the logical partition.

The logical partition SHALL have no other subelements than the **Identical** element and no additional attributes other than those specified by **@PartIDKeys**.

The master partition identified by **Identical/Part** SHALL be either a partition leaf or at the same partition level of the logical partition. Such a master partition SHALL NOT contain an **Identical** element. In this way, the logical partition obeys the rules described in ▶ Section 3.10.5.3 Relating PartIDKeys and Partitions.

Example 3.25: ResourceLink with Part Element

The **ExposedMedia** example above is valid, because both the logical and physical partition level equals the **@Side** partition level. The following **ResourceLink** illustrates a valid partition sequence:

```
<ExposedMediaLink Usage="Input" rRef="L1">
  <Part Separation="Black" SheetName="S2" Side="Back"/>
</ExposedMediaLink>
```

Example 3.26: Partitioning with an Invalid Identical Element

This example illustrates an INVALID logical partition, because logical and physical partition level are not equal and the physical partition level is not a leaf.

```
<ExposedMedia Class="Handling" ID="L2"
  PartIDKeys="SheetName Side Separation" Status="Available">
  <ExposedMedia SheetName="S1">
    <ExposedMedia Side="Front">
      <ExposedMedia ProductID="1" Separation="Cyan"/>
      <ExposedMedia ProductID="2" Separation="Magenta"/>
      <ExposedMedia ProductID="3" Separation="Yellow"/>
      <ExposedMedia ProductID="4" Separation="Black"/>
    </ExposedMedia>
    <ExposedMedia Side="Back">
      <ExposedMedia ProductID="5" Separation="Cyan"/>
      <ExposedMedia ProductID="6" Separation="Magenta"/>
      <ExposedMedia ProductID="7" Separation="Yellow"/>
      <ExposedMedia ProductID="8" Separation="Black"/>
    </ExposedMedia>
  </ExposedMedia>
  <ExposedMedia SheetName="S2">
    <ExposedMedia Side="Front">
      <ExposedMedia ProductID="9" Separation="Cyan">
        <!--This Identical is invalid because it references from a
          Separation partition to a Surface partition -->
        <Identical>
          <Part SheetName="S1" Side="Back"/>
        </Identical>
      </ExposedMedia>
    </ExposedMedia>
  </ExposedMedia>
</ExposedMedia>
```

3.10.6 PartIDKeys Attribute and Partition Keys

New in JDF 1.2

3.10.6.1 Partitionable Resource

In addition to the usual resource attributes and elements, the partitionable resource element has partition-specific attributes and elements in its root. Specifying `@PartIDKeys` in the root defines a partitioned resource. Throughout this document, the term “Partition Key” (depending on the context) refers to either

- an enumeration value of the `@PartIDKeys` attribute (e.g., “Side”)

```
<ExposedMedia PartIDKeys="Side" ...>
```
- an attribute with one of two specialized functions the can either identify a partition (e.g., `@Side`)

```
<ExposedMedia ID="XM" ...>
  <ExposedMedia Side="Front" ...>
</ExposedMedia>
```

 or reference a partition from within a `Part` element (e.g., `@Side`)

```
<ExposedMediaLink rRef="XM" ...>
  <Part Side="Front"/>
</ExposedMediaLink>
```

Further attributes that apply to partitioned resources are listed in the following table.

Table 3.21: Partitionable Resource Element

NAME	DATA TYPE	DESCRIPTION
<i>PartIDKeys</i> ? Modified in JDF 1.6	enumerations	List of attribute names that are used to separate the individual parts. <i>@PartIDKeys</i> also defines the sequence from root to leaf in which the <i>@PartIDKeys</i> SHALL occur in the partitioned resource. Each entry in the <i>@PartIDKeys</i> list SHALL occur only once. <i>@PartIDKeys</i> SHALL NOT be specified below the root of a partitioned resource. For details, see ▶ Table 3.23 Part Element. Modification note: Before JDF 1.4, <i>Part/@Sorting</i> and <i>Part/@SortAmount</i> were not valid values of <i>@PartIDKeys</i> . Now they have been deprecated so all values of <i>@PartIDKeys</i> are also elements of <i>Part</i> . Allowed values are from: ▶ Table 3.22 PartIDKey Attribute Values
<i>PipePartIDKeys</i> ? New in JDF 1.2	enumerations	Defines the granularity of a dynamic pipe for a partitioned resource. For instance, if a resource were partitioned by sheet, surface and separation (i.e., <i>Resource/@PartIDKeys = "SheetName Side Separation"</i>), and if the <i>ResourceLink/@PipePartIDKeys = "SheetName Side"</i> , then pipe requests would be issued only once per surface. The contents of <i>@PipePartIDKeys</i> SHALL be a subset of the <i>@PartIDKeys</i> attribute of the resource that is linked by this <i>ResourceLink</i> . Default value is from: <i>@PartIDKeys</i> (i.e., maximum granularity). <i>@PipePartIDKeys</i> SHALL NOT be specified below the root of a partitioned resource. For details on partitioned resources, see ▶ Section 3.10.5 Description of Partitioned Resources. Allowed values are from: ▶ Table 3.22 PartIDKey Attribute Values.
<i>Identical</i> ?	element	Cross reference to a logical partition. For details on logical partitions and the <i>Identical</i> element, see ▶ Section 3.10.5.5 Logical Partitions and the Identical Element.
<i>Resource</i> *	element	Nested resource elements that contain the appropriate partition keys as specified in <i>@PartIDKeys</i> . These elements SHALL be of the same name and type as the root <i>Resource</i> element. They represent the individual parts or groups of parts.

Table 3.22: PartIDKey Attribute Values

PARTIDKEY VALUES			
BinderySignatureName	DocRunIndex	Metadata8	SectionIndex
BinderySignaturePagingIndex	DocSheetIndex	Metadata9	Separation
BlockName	DocTags	Option	SetCopies
BundleItemIndex	Edition	PageNumber	SetDocIndex
CellIndex	EditionVersion	PageTags	SetIndex
Condition	FountainNumber	PartVersion	SetRunIndex
DeliveryUnit0	ItemNames	PlateLayout	SetSheetIndex
DeliveryUnit1	LayerIDs	PreflightRule	SetTags
DeliveryUnit2	Location	PreviewType	SheetIndex
DeliveryUnit3	LotID	PrintCondition	SheetName
DeliveryUnit4	Metadata0	ProductPart	Side
DeliveryUnit5	Metadata1	RibbonName	SignatureName
DeliveryUnit6	Metadata2	Run	StationName
DeliveryUnit7	Metadata3	RunIndex	SubRun
DeliveryUnit8	Metadata4	RunPage	TileID
DeliveryUnit9	Metadata5	RunPageRange	WebName
DocCopies	Metadata6	RunSet	WebProduct
DocIndex	Metadata7	RunTags	WebSetup

3.10.6.2 Part

Partitionable resources are uniquely identified by the attribute values listed in `@PartIDKeys` attributes. The choice of which attributes to use depends on how the agent organizes the job.

The following table lists the content of a **Part** element, which contains a set of attributes that have a well described meaning. Each of the attributes, except `@Sorting`, MAY be used in the nested resource elements of partitioned resources as the partition key (see example above).

Part elements match a given partition when all of the attributes of a **Part** element match the attributes of the referenced resource. This corresponds to Boolean AND operation. Note that a **Part** element MAY specify a subset of the partition keys (e.g., only lower level partition keys) and thus implicitly select multiple partitions leaves or nodes from a partitioned resource (see ▶ Section 3.10.7.4 Implicit, Sparse and Explicit PartUsage in Partitioned Resources). If multiple **Part** elements are specified, the result is a Boolean OR of the multiple parts. A **Part** element with no attributes explicitly references the root resource.

Some attributes of **Part** (`@Separation`, `@SheetName`, `@SignatureName`) have a data type of string. Future versions of this specification may restrict the data type to NMTOKEN. Therefore implementations SHOULD write values as NMTOKEN. Compliant implementations SHALL be capable of reading string values.

Table 3.23: Part Element (Sheet 1 of 7)

NAME	DATA TYPE	DESCRIPTION
<i>BinderySignatureName</i> ? New in JDF 1.2	NMTOKEN	Name of the <i>BinderySignature</i> used in a <i>StrippingParams</i> description.
<i>BinderySignaturePaginationIndex</i> ? New in JDF 1.4	IntegerRangeList	<code>@BinderySignaturePaginationIndex</code> defines indices of the pages of the pagination sequence of <i>StrippingParams/StripCellParams</i> elements or <i>BinderySignature/SignatureCell</i> elements. Elements are counted by their pagination index. The index is zero based and is local in the <i>BinderySignature</i> , not the pagelist of the job.
<i>BlockName</i> ? New in JDF 1.1	NMTOKEN	Identifies a <i>CutBlock</i> from a <i>Cutting</i> process. The value of this attribute SHALL match the value of the <code>@BlockName</code> attribute of a <i>CutBlock</i> .
<i>BundleItemIndex</i> ? New in JDF 1.2	IntegerRangeList	The <code>@BundleItemIndex</code> attribute selects a set of <i>BundleItem</i> elements from a <i>Component</i> resource.
<i>CellIndex</i> ? New in JDF 1.2	IntegerRangeList	Index of <i>SignatureCell</i> elements in a <i>StrippingParams</i> or <i>BinderySignature</i> . <i>SignatureCell</i> elements are counted starting from lower left. Each row is indexed from left to right before moving up to the next row.
<i>Condition</i> ? New in JDF 1.2	NMTOKEN	The <code>@Condition</code> attribute was added to JDF 1.2 to allow users of JDF -enabled systems to define and track different kinds of waste for improved error reporting and production statistics. Values include those from: ▶ Table 3.24 Condition Attribute Values.
<i>DeliveryUnit0</i> ? New in JDF 1.3	NMTOKEN	Specifies a hierarchical manifest of delivery packages where <code>@DeliveryUnit0</code> specifies the most granular bundle. <code>@DeliveryUnit<N+1></code> specifies the next most granular bundle in packing after <code>@DeliveryUnit<N></code> . Bundles can be packaged with varying numbers of products. <code>@DeliveryUnit<N+1></code> SHALL occur before <code>@DeliveryUnit<N></code> in <code>@PartIDKeys</code> . Note: N is a placeholder for the values 0 through 9.
<i>DeliveryUnit1</i> ? New in JDF 1.3	NMTOKEN	See <code>@DeliveryUnit0</code> .
<i>DeliveryUnit2</i> ? New in JDF 1.3	NMTOKEN	See <code>@DeliveryUnit0</code> .
<i>DeliveryUnit3</i> ? New in JDF 1.3	NMTOKEN	See <code>@DeliveryUnit0</code> .
<i>DeliveryUnit4</i> ? New in JDF 1.3	NMTOKEN	See <code>@DeliveryUnit0</code> .

Table 3.23: Part Element (Sheet 2 of 7)

NAME	DATA TYPE	DESCRIPTION
<i>DeliveryUnit5</i> ? New in JDF 1.3	NMTOKEN	See @DeliveryUnit0 .
<i>DeliveryUnit6</i> ? New in JDF 1.3	NMTOKEN	See @DeliveryUnit0 .
<i>DeliveryUnit7</i> ? New in JDF 1.3	NMTOKEN	See @DeliveryUnit0 .
<i>DeliveryUnit8</i> ? New in JDF 1.3	NMTOKEN	See @DeliveryUnit0 .
<i>DeliveryUnit9</i> ? New in JDF 1.3	NMTOKEN	See @DeliveryUnit0 .
<i>DocCopies</i> ?	IntegerRangeList	Identifies a set of document copies to which the partition applies.
<i>DocIndex</i> ?	IntegerRangeList	The @DocIndex attribute selects a set of logical instance documents from a RunList resource.
<i>DocRunIndex</i> ?	IntegerRangeList	The @DocRunIndex attribute selects a set of logical pages from instance documents of a RunList resource. For example, @DocRunIndex = "0 -1" specifies the first and last page of every copy of every selected instance document (assuming that additional partitioning using @DocCopies and/or @DocIndex is not also specified). The index always refers to entries of the entire RunList and SHALL NOT be modified if only a part of the RunList is spawned. Specifying @DocRunIndex does not modify the index of a RunList entry and therefore does not reposition pages on a Layout .
<i>DocSheetIndex</i> ?	IntegerRangeList	The @DocSheetIndex attribute selects a set of logical sheets from individual instance documents. For example @DocSheetIndex = "0 -1" specifies the first and last sheet of every selected copy of every instance document (assuming that additional partitioning using @DocCopies and/or @DocIndex is not also specified). The index always refers to entries of the entire RunList and SHALL NOT be modified if only a part of the RunList is spawned. Specifying @DocSheetIndex does not modify the index of a RunList entry and therefore does not reposition pages on a Layout .
<i>DocTags</i> ? New in JDF 1.3 Modified in JDF 1.4	NameRangeList	List of tags of documents in a multi-document RunList . Used to partition resources that are linked from processes that also have a RunList as input. The partition is selected if the implied value (i.e., from the PDL) of the document in the RunList matches any of the entries in @DocTags Note that being a multi-set RunList implies being a multi-document RunList as well. Modification note: Starting with JDF 1.4, the data type was expanded from NMTOKENS to NameRangeList.
<i>Edition</i> ? New in JDF 1.3	NMTOKEN	An @Edition addresses a subset of a published product (e.g., newspaper issue). The content of all copies of one edition is the same. Usually, an edition is published for a specific region and/or publishing time (e.g., Asia/Europe edition or Morning/Evening edition).
<i>EditionVersion</i> ? New in JDF 1.3	NMTOKEN	An edition version is an OPTIONAL subset of a single edition. In order to ship inserts, editions might be subdivided into edition versions.
<i>FountainNumber</i> ?	integer	Zero-based position index of the fountain. Used to partition fountains along the axis of a roller; can be used for web printing.
<i>ItemNames</i> ? New in JDF 1.2	NMTOKENS	List of items to select from a Bundle . Default behavior: all BundleItem elements are processed.
<i>LayerIDs</i> ? New in JDF 1.1	IntegerRangeList	The @LayerIDs attribute selects a set layers that are defined by @LayerID . Default behavior: all layers are processed.

Table 3.23: Part Element (Sheet 3 of 7)

NAME	DATA TYPE	DESCRIPTION
Location ? Modified in JDF 1.3	NMTOKEN	Name of the location (e.g., in MIS). This part key allows to describe distributed resources. Note that this name does not define the location by itself. See ▶ Section 3.10.6.4 Locations of PhysicalResources for details on specifying locations. Values include those from: ▶ Input Tray and Output Bin Names. Note: The specified values are for printer locations.
LotID ? New in JDF 1.6	NMTOKEN	Identifier of the lot of a resource in a lot controlled environment.
Metadata0 ? New in JDF 1.4	NameRange-List	Metadata extracted from a PDL using RunList / MetadataMap elements. See ▶ Section 9.32 MetadataMap.
Metadata1 ? New in JDF 1.4	NameRange-List	See @Metadata0 .
Metadata2 ? New in JDF 1.4	NameRange-List	See @Metadata0 .
Metadata3 ? New in JDF 1.4	NameRange-List	See @Metadata0 .
Metadata4 ? New in JDF 1.4	NameRange-List	See @Metadata0 .
Metadata5 ? New in JDF 1.4	NameRange-List	See @Metadata0 .
Metadata6 ? New in JDF 1.4	NameRange-List	See @Metadata0 .
Metadata7 ? New in JDF 1.4	NameRange-List	See @Metadata0 .
Metadata8 ? New in JDF 1.4	NameRange-List	See @Metadata0 .
Metadata9 ? New in JDF 1.4	NameRange-List	See @Metadata0 .
Option ? Modified in JDF 1.3	NMTOKEN	Generic option that MAY be semantic free. MAY also be used for options from an RFQ in an intent resource.
PageNumber ?	IntegerRangeList	Page number in a Component or document (e.g., FileSpec that is not described as a RunList). References an index in a PageList .
PageTags ? New in JDF 1.3 Modified in JDF 1.4	NameRange-List	List of tags of pages in a multi-page RunList . Used to partition resources that are linked from processes that also have a RunList as input. The partition is selected if the implied value (i.e., from the PDL) of the page in the RunList matches any of the entries in @PageTags . Modification note: Starting with JDF 1.4 , the data type was expanded from NMTOKENS to NameRangeList.
PartVersion ? Modified in JDF 1.3	NMTOKENS	Version identifier (e.g., the language version of a catalog). Compatibility note: The data type of @PartVersion was changed from string to NMTOKENS in JDF 1.3 in order to accommodate resources that contain elements from multiple versions (e.g., Sheets with two language versions).
PlateLayout ? New in JDF 1.3	NMTOKEN	Identifier of a single plate layout (mainly used for newspaper processes, where multiple plates are needed for one cylinder)

Table 3.23: Part Element (Sheet 4 of 7)

NAME	DATA TYPE	DESCRIPTION
<i>PreflightRule</i> ? New in JDF 1.2 Modified in JDF 1.3	NMTOKEN	Definition of the specific parts of a <i>PreflightReportRulePool/PRRule</i> used in preflight applications.
<i>PreviewType</i> ? New in JDF 1.1 Modified in JDF 1.5	enumeration	Preview specifies the type and usage of a <i>Preview</i> . @ <i>PreviewType</i> SHALL NOT be specified for resources other than <i>Preview</i> or <i>PreviewGenerationParams</i> . Allowed values are: <i>Animation</i> – animated previews for 3D display. New in JDF 1.5. <i>Identification</i> – <i>Preview</i> is used as a visual help to identify one or more products, e.g. on a gang form. New in JDF 1.5. <i>SeparatedThumbNail</i> – Very low resolution separated preview. <i>Separation</i> – Separated preview in medium resolution. <i>SeparationRaw</i> – Separated preview in medium resolution with no compensation. New in JDF 1.2 <i>Static3D</i> – static 3D model. New in JDF 1.5 <i>ThumbNail</i> – Very low resolution RGB preview. <i>Viewable</i> – RGB preview in medium resolution.
<i>PrintCondition</i> ? New in JDF 1.6	NMTOKEN	@ <i>PrintCondition</i> specifies a characterization data set that is applied to a specific setup including paper selection and screening setup. See ▶ Appendix A.4.17 PrintStandard Characterization Data Sets for details of characterization data sets.
<i>ProductPart</i> ? New in JDF 1.5	NMTOKEN	References the Product/@ <i>ID</i> that this <i>Part</i> applies to.
<i>RibbonName</i> ? Modified in JDF 1.3	NMTOKEN	A string that uniquely identifies each ribbon. Multiple ribbons are created out of one web after dividing in case of web printing.
<i>Run</i> ? Modified in JDF 1.3	NMTOKEN	The @ <i>Run</i> attribute selects an individual <i>RunList</i> partition from a <i>RunList</i> resource.
<i>RunIndex</i> ?	IntegerRangeList	The @ <i>RunIndex</i> attribute selects a set of logical pages from a <i>RunList</i> resource in a manner that is independent from the internal structure of the <i>RunList</i> . It contains an array of mixed ranges and individual indices separated by whitespace. Each range consists of two indices connected with a tilde (~). For example, @ <i>RunIndex</i> = "2 ~ 5 8 10 22 ~ -1". Negative numbers reference pages from the back of a file in base-1 counting. In other words, -1 is the last page, -2 the second to last, etc. Thus @ <i>RunIndex</i> = "0 ~ -1" refers to a complete range of pages, from first to last. The index always refers to entries of the entire <i>RunList</i> and SHALL NOT be modified if only a part of the <i>RunList</i> is spawned. Specifying @ <i>RunIndex</i> does not modify the index of a <i>RunList</i> entry and therefore does not reposition pages on a <i>Layout</i> .
<i>RunPage</i> ? New in JDF 1.1	integer	Zero-based page number. Used when a document/file-based <i>RunList</i> is broken down into a page based <i>RunList</i> . For instance, a 2-page document <i>RunList</i> : <RunList URL="doc.pdf" (...) /> is split into: <RunList PartIDKeys="RunPage" (...) > <RunList URL="doc_page0.pdf" RunPage="0" (...) /> <RunList URL="doc_page1.pdf" RunPage="1" (...) /> </RunList>
<i>RunPageRange</i> ? New in JDF 1.4	IntegerRangeList	Used when splitting <i>RunList</i> resources into larger chunks that are not yet based on <i>PageList</i> indices.
<i>RunSet</i> ? New in JDF 1.3	NMTOKEN	Generic group of elements in a <i>RunList</i> . If partitioning a <i>RunList</i> by @ <i>RunSet</i> and @ <i>Run</i> , then @ <i>RunSet</i> SHOULD be specified closer to the root.

Table 3.23: Part Element (Sheet 5 of 7)

NAME	DATA TYPE	DESCRIPTION
<p><i>RunTags</i> ?</p> <p>New in JDF 1.1</p> <p>Modified in JDF 1.4</p>	NameRange-List	<p>List of names in a named <i>RunList</i>. Used to partition resources that are linked from processes that also have a <i>RunList</i> as input when the sequence of the <i>RunList</i> is undefined. The partition is selected if the explicit or implied (e.g., from the PDL) value of <i>@RunTag</i> of the <i>RunList</i> matches any of the entries in <i>@RunTags</i>.</p> <p>Note: The difference between <i>@RunTags</i> and <i>@PageTags</i>, <i>@DocTags</i> or <i>@SetTags</i>. <i>@PageTags</i> is used to identify classes of individual pages having differing JDF parameterization. Similarly, <i>@DocTags</i> is used to identify classes of individual documents and <i>@SetTags</i> is used to identify classes of individual sets each having differing JDF parameterization. <i>@RunTags</i> is used to identify collections of pages, often thought of as a document or a piece of a document, but not limited to that. Also, <i>@RunTags</i> MAY be explicitly set for an entire <i>RunList</i> by use of the <i>@RunTag</i> attribute. The <i>@SetTags</i>, <i>@DocTags</i> and <i>@PageTags</i> partition keys are always set implicitly and always refer to the granularity within a <i>@RunList</i> implied by their names.</p> <p>Modification note: Starting with JDF 1.4, the data type was expanded from NMTOKENS to NameRangeList.</p>
<p><i>SectionIndex</i> ?</p> <p>New in JDF 1.2</p>	IntegerRangeList	List of sections in a <i>StrippingParams</i> .
<p><i>Separation</i> ?</p>	string	<p>Identifies the separation name.</p> <p>Values include:</p> <p>Composite – Non-separated resource.</p> <p>Separated – The resource is separated, but the separation definition is handled internally by the resource, such as a PDF file that contains SeparationInfo dictionaries.</p> <p>Cyan – Process color.</p> <p>Magenta – Process color.</p> <p>Yellow – Process color.</p> <p>Black – Process color.</p> <p>Red – Additional process color.</p> <p>Green – Additional process color.</p> <p>Blue – Additional process color.</p> <p>Orange – Additional process color.</p> <p>Spot – Generic spot color. Used when the exact nature of the spot color is unknown.</p> <p>Varnish – Varnish.</p> <p>Note: Other values include any separation name defined in the <i>@Name</i> attribute of a <i>Color</i> element in the <i>ColorPool</i>.</p> <p>Note: When <i>@Separation</i> is applied to a <i>ColorantControlLink</i>, it defines an implicit partition that selects a subset of separations for the process that is described by the <i>ColorantControl</i>. For details, see ▶ Section 8.21 ColorantControl.</p>
<p><i>SetCopies</i> ?</p> <p>New in JDF 1.5</p>	IntegerRangeList	Identifies a collection of set copies to which the partition applies.
<p><i>SetDocIndex</i> ?</p> <p>New in JDF 1.2</p>	IntegerRangeList	The <i>@SetDocIndex</i> attribute selects a set of logical instance documents from instance document sets of a <i>RunList</i> resource. For example, <i>@SetDocIndex</i> = "0 -1" specifies the first and last document of every copy of every selected instance document set. The index always refers to entries of the entire <i>RunList</i> and SHALL NOT be modified if only a part of the <i>RunList</i> is spawned. Specifying <i>@SetDocIndex</i> does not modify the index of a <i>RunList</i> entry and therefore does not reposition pages on a <i>Layout</i> .
<p><i>SetIndex</i> ?</p> <p>New in JDF 1.1</p>	IntegerRangeList	The <i>@SetIndex</i> attribute selects a set of logical instance document sets from a <i>RunList</i> resource. The index always refers to entries of the entire <i>RunList</i> and SHALL NOT be modified if only a part of the <i>RunList</i> is spawned. Specifying <i>@SetIndex</i> does not modify the index of a <i>RunList</i> entry and therefore does not reposition pages on a <i>Layout</i> .

Table 3.23: Part Element (Sheet 6 of 7)

NAME	DATA TYPE	DESCRIPTION
SetRunIndex ? New in JDF 1.2	IntegerRangeList	The @SetRunIndex attribute selects a set of logical pages from instance document sets of a RunList resource. For example, @SetRunIndex = "0 -1" specifies the first and last page of every copy of every selected instance document set. The index always refers to entries of the entire RunList and SHALL NOT be modified if only a part of the RunList is spawned. Specifying @SetRunIndex does not modify the index of a RunList entry and therefore does not reposition pages on a Layout .
SetSheetIndex ? New in JDF 1.2	IntegerRangeList	The @SetSheetIndex attribute selects a set of logical sheets from individual sets of instance documents. For example @SetSheetIndex = "0 -1" specifies the first and last sheet of every selected copy of every set. The index always refers to entries of the entire RunList and SHALL NOT be modified if only a part of the RunList is spawned. Specifying @SetSheetIndex does not modify the index of a RunList entry and therefore does not reposition pages on a Layout .
SetTags ? New in JDF 1.3 Modified in JDF 1.4	NameRangeList	List of tags of pages in a multi-set RunList . Used to partition resources that are linked from processes that also have a RunList as input. The partition is selected if the implied value (i.e., from the PDL) of the set in the RunList matches any of the entries in @SetTags . Modification note: Starting with JDF 1.4 , the data type was expanded from NMTOKENS to NameRangeList.
SheetIndex ? Modified in JDF 1.4	IntegerRangeList	The @SheetIndex attribute selects a set of logical sheets from a RunList resource either implicitly or explicitly partitioned by @SheetIndex . @SheetIndex is only valid when a RunList is describing sheet/surfaces.
SheetName ?	string	A string that uniquely identifies each sheet.
Side ?	enumeration	Denotes the side of the sheet. If @Side is specified, the Part element refers to one surface of the sheet. If it is not specified, it refers to both sides. In case of web printing, "Front" is a synonym for the upper side and "Back" for the down side of the web. Allowed values are: Front Back
SignatureName ?	string	A string that uniquely identifies the signature within the partitioned resource.
Sorting ? Deprecated in JDF 1.4	IntegerRangeList	Mapping from the implied partitioned resource order to a process order. The indices refer to the elements of the complete partitioned resource, not to the index in the selection of parts defined by the Part element. If not specified the part order is the same as the sorting order. @Sorting SHALL NOT be used as a partition key. Note: @Sorting and @SortAmount are semantically different from the other attributes in this table as they define the ordering of parts, whereas the other attributes define the selection of parts. Deprecation note: The order of the Part elements contained in a ResourceLink is significant: the specified subsets of the resource are selected in the XML order of the Part elements.
SortAmount ? Deprecated in JDF 1.4	boolean	If a sorted resource has an @Amount attribute and @SortAmount = "true", each resource SHALL be processed completely. If @SortAmount = "false" (the default), each Part element SHALL be processed the number of times specified in the @Amount attribute before starting the next Part . @SortAmount SHALL NOT be used as a partition key. Deprecation note: See @Sorting .
StationName ? New in JDF 1.3	string	The name of the 1-up design in a DieLayout .
SubRun ? New in JDF 1.3	NMTOKEN	Defines individual sub-runs in a production run. For instance, Media might vary over the duration of a longer run. The variation might be only stock numbers, but physical characteristics might also vary.

Table 3.23: Part Element (Sheet 7 of 7)

NAME	DATA TYPE	DESCRIPTION
<i>TileID</i> ? Modified in JDF 1.3	XYPair	XYPair of integer values that identifies the tile. Tiles are identified by their X and Y indexes. Values are zero-based and SHALL originate at the lower left. So "0 0" is the lower left tile and "1 0" is the tile next to it on the right. Tile resources are described in detail in the ▶ Section 8.156 Tile. In JDF 1.3 and beyond, @TileID SHOULD NOT be used to specify multiple plates per cylinder. Instead the new resource CylinderLayout SHOULD be used.
<i>WebName</i> ? Modified in JDF 1.3	NMTOKEN	A string that uniquely identifies each web.
<i>WebProduct</i> ? New in JDF 1.3	NMTOKEN	Name of a product that will be produced on a web press. Multiple web products MAY be produced simultaneously on one web press.
<i>WebSetup</i> ? New in JDF 1.3	NMTOKEN	Defines one setup of a web press that MAY produce multiple web products.

Table 3.24: Condition Attribute Values

VALUE	DESCRIPTION
Good	All correct components.
Waste	General waste.
Overrun	Excess Component resource(s) that were produced by running the device after the specified amount has been produced.
xxxGood	Like "Good" above, but where "xxx" can be the name of any JDF process (e.g., "FeedingGood", "TrimmingGood", etc.). In the case of a combined process or process group, the name of the last JDF process in the process chain is used.
xxxWaste	Like "Waste" above, but where "xxx" can be the name of any JDF process (e.g., "FeedingWaste", "TrimmingWaste", etc.). In the case of a combined process or process group, the name of the last JDF process in the process chain is used.
AuxiliarySheet New in JDF 1.4	This value identifies the Media that was consumed as specified by InsertSheet/@SheetType="AccountingSheet", "ErrorSheet", "JobSheet" or "SeparatorSheet" .
BindingQualityTestFailed	Failed binding quality test. The Component resource(s) with this @Condition belong to the batch of Component resource(s) that did not pass the test.
BindingQualityTestPassed	Passed binding quality test. The Component resource(s) with this @Condition belong to the batch of Component resource(s) that passed the test but were not destroyed in the process.
BindingQualityTestWaste	Passed binding quality test. The Component element(s) with this @Condition belong to the batch of Component element(s) that passed the test but were destroyed in the process.
CaliperWaste	Waste by caliper on gathering / collecting.
DoubleFeedWaste	Waste by double feeds on feeders.
IncorrectComponentWaste	Waste by the attempted use of an incorrect components (e.g., on a feeder).
BadFeedWaste	Waste caused by a bad feed
ObliqueSheetWaste	Waste by oblique sheets on gathering / collecting chains.
PaperJamWaste	Waste by paper or other media jam.
Reusable New in JDF 1.4	Waste to be used for setup in the next process.
WhitePaperWaste	White paper waste.

3.10.6.3 Options in Intent Resources

JDF defines "Option" as a partition key in order to specify multiple options (e.g., for multiple quotes in a non-redundant manner). A [ResourceLink](#) that links to a resource with an "Option" partition but has no [Part](#) element to choose the "Option" defaults to the root resource.

3.10.6.4 Locations of PhysicalResources

Unlike other kinds of resources, [PhysicalResources](#) can be stored at multiple, distributed locations. This is specified by including a [Location](#) element in the resource element. A [@Location](#) partition key is provided to define multiple locations of one resource. The partition key carries no semantic meaning and does not by itself define the name of a location.

Example 3.27: ExposedMedia with Location Elements

The following example describes a set of plates that are distributed over two locations.

Note: See ▶ Appendix A.4.9 Input Tray and Output Bin Names for additional detail on locating [PhysicalResource](#) items.

```
<ResourcePool>
  <ExposedMedia Class="Handling" ID="L1" PartIDKeys="Location" Status="Available">
    <ExposedMedia Amount="42" Location="dd1">
      <Location LocID="PP_01234" LocationName="Desk Drawer 1"/>
    </ExposedMedia>
    <ExposedMedia Amount="100" Location="dd2">
      <Location LocID="PP_01235" LocationName="Desk Drawer 2"/>
    </ExposedMedia>
  </ExposedMedia>
</ResourcePool>
<ResourceLinkPool>
  <ExposedMediaLink Amount="50" Usage="Input" rRef="L1">
    <Part Location="dd2"/>
    <!-- Note that @Location can but need not match
         Location/@LocationName
    -->
  </ExposedMediaLink>
</ResourceLinkPool>
```

Example 3.28: Media with Location Elements

The following example describes two different media in the top and bottom tray of a [LayoutPreparation](#) process. The media is selected for the cover and inside pages respectively.

```
<Media Class="Consumable" ID="TopMedia" Status="Available">
  <Location LocationName="Top"/>
</Media>
<Media Class="Consumable" ID="BottomMedia" Status="Available">
  <Location LocationName="Bottom"/>
</Media>
<LayoutPreparationParams Class="Parameter" ID="L1"
  PartIDKeys="RunIndex" Sides="TwoSidedFlipY" Status="Available">
  <!-- Partition that defines the first and last page of the document -->
  <LayoutPreparationParams RunIndex="0 1 -2 -1">
    <MediaRef rRef="TopMedia"/>
  </LayoutPreparationParams>
  <!-- Partition that defines the inside pages of the document -->
  <LayoutPreparationParams RunIndex="2 ~ -3">
    <MediaRef rRef="BottomMedia"/>
  </LayoutPreparationParams>
</LayoutPreparationParams>
```

3.10.7 Linking to Resources

Modification note: Starting with JDF 1.4, all text up to ▶ Section 3.10.7.3 Handling Amount in a ResourceLink to a Partitioned Resource is new and replaces now-deleted text that was present in JDF 1.3

A JDF node can specify a reordering or subset of a resource by including one or more [Part](#) elements in the [ResourceLink](#) element that links to that resource. For details of the [Part](#) element, please refer to ▶ Table 3.23 Part Element.

3.10.7.1 Linking to Subsets of Resources

Each **ResourceLink/Part** element selects a subset of the resource, where the aggregation of each selected subset (in the case of multiple **ResourceLink/Part** elements) creates a “virtual” resource that will then be used during node processing. This feature is often useful to reproduce part of the job described by a node, as the default interpretation of the **Part** elements maintains the context as if the node had been executed without any **ResourceLink** partitioning.

Example 3.29: Linking to Subsets of Resources

For instance, if an **Imposition** process outputs multiple sheets, and each sheet has dynamic marks placed on the sheet based on the value of `@SheetIndex`, selecting a single sheet to be processed by **Imposition** would produce that sheet using the original `@SheetIndex` value. This example would generate the imposed sheet #5 followed by the imposed sheet #1, where all dynamic marks on both sheets retain the context in which `@SheetIndex` would have been defined when processing the full **RunList** resource.

```
<ResourcePool>
  <RunList Class="Parameter" ID="SheetSurfacesGeneratedByImposition"
    PartIDKeys="SheetIndex" Status="Available">
    <RunList SheetIndex="1"/>
    <RunList SheetIndex="3"/>
    <RunList SheetIndex="5"/>
  </RunList>
</ResourcePool>
<ResourceLinkPool>
  <RunListLink Usage="Output" rRef="SheetSurfacesGeneratedByImposition">
    <!-- output of imposition -->
    <Part SheetIndex="5"/>
    <Part SheetIndex="1"/>
  </RunListLink>
</ResourceLinkPool>
```

3.10.7.2 Reordering the Processing of Resources

ResourceLink partitioning may also be used to reorder the processing order of content described by a **RunList**. This is done by using the **RunList/@IgnoreContext** attribute, which specifies which **Part** element partition keys' job context SHOULD be ignored during processing. For more information and an example of this, see **RunList/@IgnoreContext** in ▶ Section 8.130 **RunList** and following the **RunList** table, see. ▶ Example 639 **RunList/MetadataMap**.

3.10.7.3 Handling Amount in a ResourceLink to a Partitioned Resource

The `@Amount` specified in a **ResourceLink** to a **PhysicalResource** specifies the sum of individual resource partitions. Individual amounts are specified in the **PartAmount** elements of the **AmountPool**.

Example 3.30: Amount in an ExposedMediaLink to a Partitioned ExposedMedia

The following example shows the **ResourceLink** that refers to ▶ Example 75 **Partitioned ExposedMedia** for a total of five plates.

```
<ExposedMediaLink Usage="Input" rRef="E1">
  <Part Separation="Cyan" SheetName="S1"/>
  <Part Separation="Magenta" SheetName="S1"/>
  <AmountPool>
    <PartAmount>
      <Part Separation="Cyan" SheetName="S1" Side="Front"/>
    </PartAmount>
    <PartAmount>
      <Part Separation="Cyan" SheetName="S1" Side="Back"/>
    </PartAmount>
    <PartAmount>
      <Part Separation="Magenta" SheetName="S1" Side="Front"/>
    </PartAmount>
    <PartAmount Amount="2">
      <Part Separation="Magenta" SheetName="S1" Side="Back"/>
    </PartAmount>
  </AmountPool>
</ExposedMediaLink>
```

3.10.7.4 Implicit, Sparse and Explicit PartUsage in Partitioned Resources

New in JDF 1.2

STRUCTURE

The `@PartUsage` attribute defines how over-specified `ResourceLink` elements SHALL be resolved.

If `@PartUsage = "Explicit"`, `ResourceLink` elements that do not point to an explicitly defined partition of a resource are an error.

If `@PartUsage = "Implicit"`, `ResourceLink` elements that do not point to an explicitly defined partition of a resource refer to the closest matching resource partition, regardless of the existence of sibling partitions with identical keys but mismatching values.

If `@PartUsage = "Sparse"`, `ResourceLink` elements that do not point to an explicitly defined partition of a resource refer to the closest matching resource partition, if no sibling partitions with identical keys but mismatching values exist. If sibling partitions with identical keys but mismatching values exist, `ResourceLink` elements that do not point to an explicitly defined partition of a resource are in error.

Example 3.31: PartUsage in a Partitioned Resource

► Table 3.25 PartUsage Attribute examples below describes the behavior of the **JDF** example that follows. ► Table 3.25 PartUsage Attribute examples shows the `@ProductID` of the resource partition that is selected for various values of `@SheetName`, `@Side`, `@Separation` and `@PartVersion` for `@PartUsage = "Implicit"`, `"Explicit"` and `"Sparse"`, respectively. Note the effects of the `Identical` element in S2B.

Table 3.25: PartUsage Attribute examples

SHEETNAME	SIDE	SEPARATION	PARTVERSION	IMPLICIT	EXPLICIT	SPARSE
—	—	—	—	Root	Root	Root
S1	—	—	—	S1	S1	S1
S2	—	—	—	S2	S2	S2
S3	—	—	—	Root	—	—
S2	Back	Cyan	—	S1BC	S1BC	S1BC
S1	Back	Cyan	—	S1BC	S1BC	S1BC
S1	Back	Orange	—	S1B	—	—
S2	Back	Orange	—	S1B	—	—
S1	—	Cyan	—	S1BC, S1FC	S1BC, S1FC	S1BC, S1FC
S1	Back	Cyan	Deutsch	S1BC	—	S1BC
S2	Back	Cyan	Deutsch	S1BC	—	S1BC
S2	Front	Cyan	Deutsch	S2FC	—	S2FC
S1	Back	Black	Deutsch	S1BKD	S1BKD	S1BKD

Note: The example below has `@PartUsage="Implicit"` and explicit values for `ExposedMediaLink/Part` attributes, but ▶ Table 3.25 PartUsage Attribute examples above describes the behavior for all values of `@PartUsage` and all values of `ExposedMediaLink/Part`.

```

<ResourceLinkPool>
  <ExposedMediaLink Usage="Input" rRef="XM_ID">
    <Part PartVersion="Deutsch" Separation="Black" SheetName="S1" Side="Front"/>
  </ExposedMediaLink>
</ResourceLinkPool>
<ResourcePool>
  <ExposedMedia Brand="Gooley" Class="Handling" ID="XM_ID"
    PartIDKeys="SheetName Side Separation PartVersion"
    PartUsage="Implicit" ProductID="Root" Status="Available">
    <Media Dimension="500 600" MediaType="Plate"/>
    <ExposedMedia ProductID="S1" SheetName="S1">
      <ExposedMedia ProductID="S1F" Side="Front">
        <ExposedMedia ProductID="S1FC" Separation="Cyan"/>
        <ExposedMedia ProductID="S1FM" Separation="Magenta"/>
        <ExposedMedia ProductID="S1FY" Separation="Yellow"/>
        <ExposedMedia ProductID="S1FK" Separation="Black">
          <ExposedMedia PartVersion="Deutsch" ProductID="S1FKD"/>
          <ExposedMedia PartVersion="English" ProductID="S1FKE"/>
        </ExposedMedia>
      </ExposedMedia>
    <ExposedMedia ProductID="S1B" Side="Back">
      <ExposedMedia ProductID="S1BC" Separation="Cyan"/>
      <ExposedMedia ProductID="S1BM" Separation="Magenta"/>
      <ExposedMedia ProductID="S1BY" Separation="Yellow"/>
      <ExposedMedia ProductID="S1BK" Separation="Black">
        <ExposedMedia PartVersion="Deutsch" ProductID="S1BKD"/>
        <ExposedMedia PartVersion="English" ProductID="S1BKE"/>
      </ExposedMedia>
    </ExposedMedia>
  </ExposedMedia>
  <ExposedMedia ProductID="S2" SheetName="S2">
    <ExposedMedia ProductID="S2F" Side="Front">
      <ExposedMedia ProductID="S2FC" Separation="Cyan"/>
      <ExposedMedia ProductID="S2FM" Separation="Magenta"/>
      <ExposedMedia ProductID="S2FY" Separation="Yellow"/>
      <ExposedMedia ProductID="S2FK" Separation="Black"/>
    </ExposedMedia>
    <ExposedMedia Side="Back">
      <Identical>
        <Part SheetName="S1" Side="Back"/>
      </Identical>
    </ExposedMedia>
  </ExposedMedia>
</ResourcePool>

```

3.10.7.5 Referencing Multiple Resources of the Same Type

Some processes (e.g., **Collecting**, **Gathering**) allow multiple input resources of the same type. These multiple input resources MAY be represented by multiple individual resources or by partitioned resources or by a mixture of both. If ordering is significant, the order of the leaves in a partitioned resource defines said ordering. ▶ Example 94 Explicit Reference of Ordered Partitioned Resources and ▶ Example 94 Implicit Reference of Ordered Partitioned Resources illustrate equivalent ways of gathering three input sheets.

For **Gathering**, **Collecting**, **Inserting** and similar processes that have multiple physical input resources, explicit links SHOULD be used to define how the output component is ordered. Implicit references of ordered partitioned resources are strongly discouraged since there is ambiguity if input components have multiple partition levels.

Example 3.32: Explicit Reference of Ordered Partitioned Resources

```

<JDF ID="Link0037" JobPartID="ID345" Status="Waiting" Type="Gathering"
  Version="1.6" xmlns="http://www.CIP4.org/JDFSchema_1_1">
  <ResourcePool>
    <GatheringParams Class="Parameter" ID="Gath01" Locked="false" Status="Available"/>
    <Component Class="Quantity" ComponentType="Sheet"
      DescriptiveName="printed insert sheets" ID="Sheets01"
      PartIDKeys="SheetName" Status="Available">
      <Component SheetName="Sheet1"/>
      <Component SheetName="Sheet2"/>
      <Component SheetName="Sheet3"/>
    </Component>
    <Component Class="Quantity" ComponentType="Sheet" ID="SheetsOut" Status="Available"/>
  </ResourcePool>
  <ResourceLinkPool>
    <GatheringParamsLink Usage="Input" rRef="Gath01"/>
    <!--three ComponentLink explicitly reference individual parts -->
    <ComponentLink Usage="Input" rRef="Sheets01">
      <Part SheetName="Sheet1"/>
    </ComponentLink>
    <ComponentLink Usage="Input" rRef="Sheets01">
      <Part SheetName="Sheet2"/>
    </ComponentLink>
    <ComponentLink Usage="Input" rRef="Sheets01">
      <Part SheetName="Sheet3"/>
    </ComponentLink>
    <ComponentLink Usage="Output" rRef="SheetsOut"/>
  </ResourceLinkPool>
</JDF>

```

Example 3.33: Implicit Reference of Ordered Partitioned Resources

```

<JDF ID="Link0037" JobPartID="ID345" Status="Waiting" Type="Gathering"
  Version="1.6" xmlns="http://www.CIP4.org/JDFSchema_1_1">
  <ResourcePool>
    <GatheringParams Class="Parameter" ID="Gath01" Locked="false" Status="Available"/>
    <Component Class="Quantity" ComponentType="Sheet"
      DescriptiveName="printed insert sheets" ID="Sheets01"
      PartIDKeys="SheetName" Status="Available">
      <Component SheetName="Sheet1"/>
      <Component SheetName="Sheet2"/>
      <Component SheetName="Sheet3"/>
    </Component>
    <Component Class="Quantity" ComponentType="Sheet" ID="SheetsOut" Status="Available"/>
  </ResourcePool>
  <ResourceLinkPool>
    <GatheringParamsLink Usage="Input" rRef="Gath01"/>
    <!--the ComponentLink implicitly references all three parts -->
    <ComponentLink Usage="Input" rRef="Sheets01"/>
    <ComponentLink Usage="Output" rRef="SheetsOut"/>
  </ResourceLinkPool>
</JDF>

```

3.10.8 Splitting and Combining Resources

Depending on the circumstances, it MAY be appropriate either to split a resource into multiple new nodes or to specify multiple locations or parts for an individual resource. There are four possible methods for splitting and combining resources. Two methods are shown in ▶ Figure 3-10: Workflow for splitting shared input resources and ▶ Figure 3-11: Workflow for combining shared output resources and represent workflows that use the *@Amount* attribute of their **ResourceLink** elements to share resources. This method is practical when one controller controls all aspects of resource consumption or production. In ▶ Figure 3-10: Workflow for splitting shared input resources, the resource amount is split between subsequent processes. In ▶ Figure 3-11: Workflow for combining shared output resources, individual processes produce amounts that are then combined into a unified resource that is, in turn, used by a single process. In both cases, a single, shared resource is employed. To enable independent parallel processing by multiple controllers, however, independent resources are needed. To create independent resources from one resource, the **Split** process is used, as shown in ▶ Figure 3-12: Workflow for splitting independent input resources (for further details, see ▶ Section 6.2.10 Split). This

process allows multiple processes to be spawned off, after which multiple processes can consume the same resource in parallel and can therefore run in parallel. ▶ Figure 3-13: Workflow for combining independent output resources demonstrates the reverse situation, which occurs if resources have been produced by multiple processes and are then consumed, as a unified entity, by a single subsequent process. To accomplish this, the **Combine** process combines multiple resources to create the single resource.

Figure 3-10: Workflow for splitting shared input resources

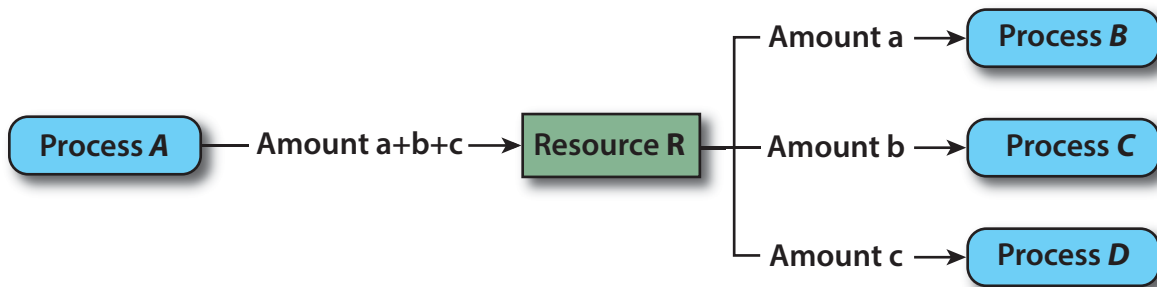

Figure 3-11: Workflow for combining shared output resources

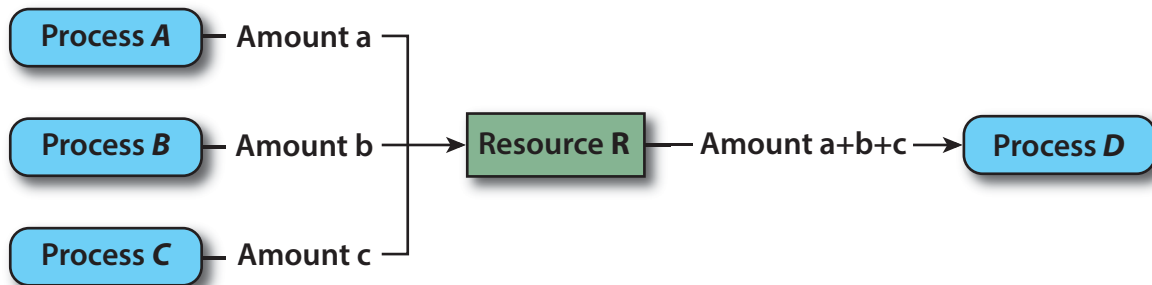

Figure 3-12: Workflow for splitting independent input resources

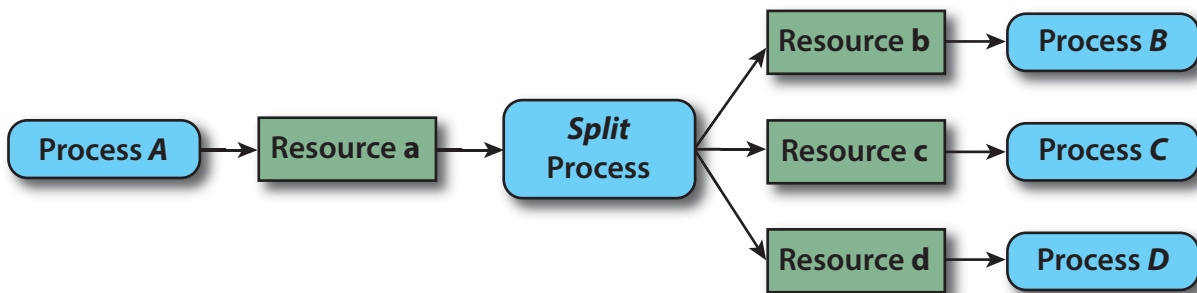
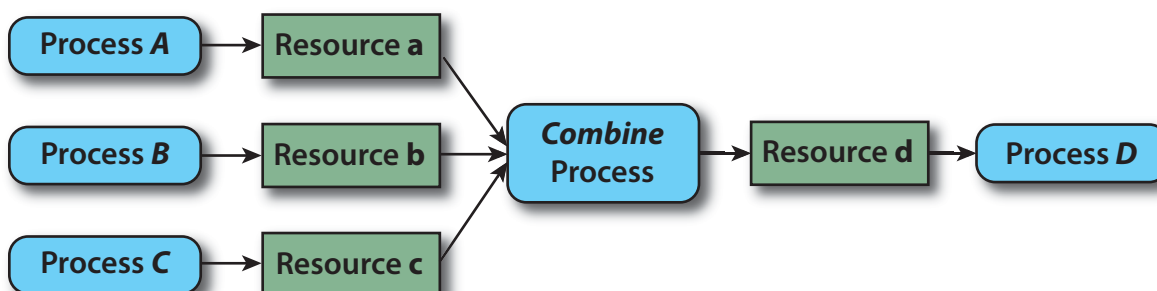

Figure 3-13: Workflow for combining independent output resources



3.11 AuditPool and Audit

Audit elements contain the post-facto recorded results of a process such as the execution of a **JDF** node or modification of the **JDF** itself. **Audit** elements become static after a process has been finished. They SHALL NOT be modified after the process has been aborted or completed. Therefore, if **PhaseTime** or **ResourceAudit** audit elements link to resources, those resources SHOULD be locked in order to inhibit accidental modification of audited information, which is why **JDF** includes a locking mechanism for resources. **Audit** elements record any event related to the following situations:

- The creation of a **JDF** node by a **Created** audit.
- Spawning and merging, including resource copying by spawned and merged audits.
- Errors such as unnecessary **ResourceLink** audits, wrongly linked resources, missing resources or missing links, which might be detected by agents during a test run or by a **Notification** audit.
- Actual data about the production and resource consumption by a **ResourceAudit** audit.
- Any process phase times. Examples include setting up a device, maintenance and washing, as well as down-times as a result of failure, breaks or pauses. Changes of **ImplementationResource** usage, such as a change of operators by a **PhaseTime** audit, would also constitute an example of a phase time.
- Actual execution data. For example, the process start and end times, as well as the final process state, as determined by a **ProcessRun** audit.
- Any modification of a **JDF** node not covered by the preceding items, as recorded by a **Modified** or **Deleted** audit.

Audit information might be used by MIS for operations such as evaluation or invoicing. The ▶ Figure 3-14: AuditPool and Abstract Audit element – a diagram of the structure depicts the structure of the **AuditPool** and concrete **Audit** elements, such as **Created**, derived from the **Abstract Audit** element. **Audit** entries are ordered chronologically, with the last entry in the **AuditPool** representing the newest. A **ProcessRun** containing the scheduling data finalizes each process run. All subsequent entries belong to the next run.

3.11.1 AuditPool

The following table defines the contents of the **AuditPool** element.

Table 3.26: AuditPool Element

NAME	DATA TYPE	DESCRIPTION
<i>rRefs</i> ? Deprecated in JDF 1.2	IDREFS	List of all resources that are referenced from within the AuditPool . In JDF 1.2 and beyond, it is up to the implementation to maintain references.
Audit *	element	Chronologically ordered list of Audit elements. The Audit elements are abstract and serve as placeholders for any concrete element derived from the Abstract Audit element. Audit elements are described in the sections that follow.



AuditPool Elements

Audit information is the job's history and can support your daily, quality control and troubleshooting management reporting needs.

3.11.2 Structure Diagram

Figure 3-14: AuditPool and Abstract Audit element – a diagram of the structure

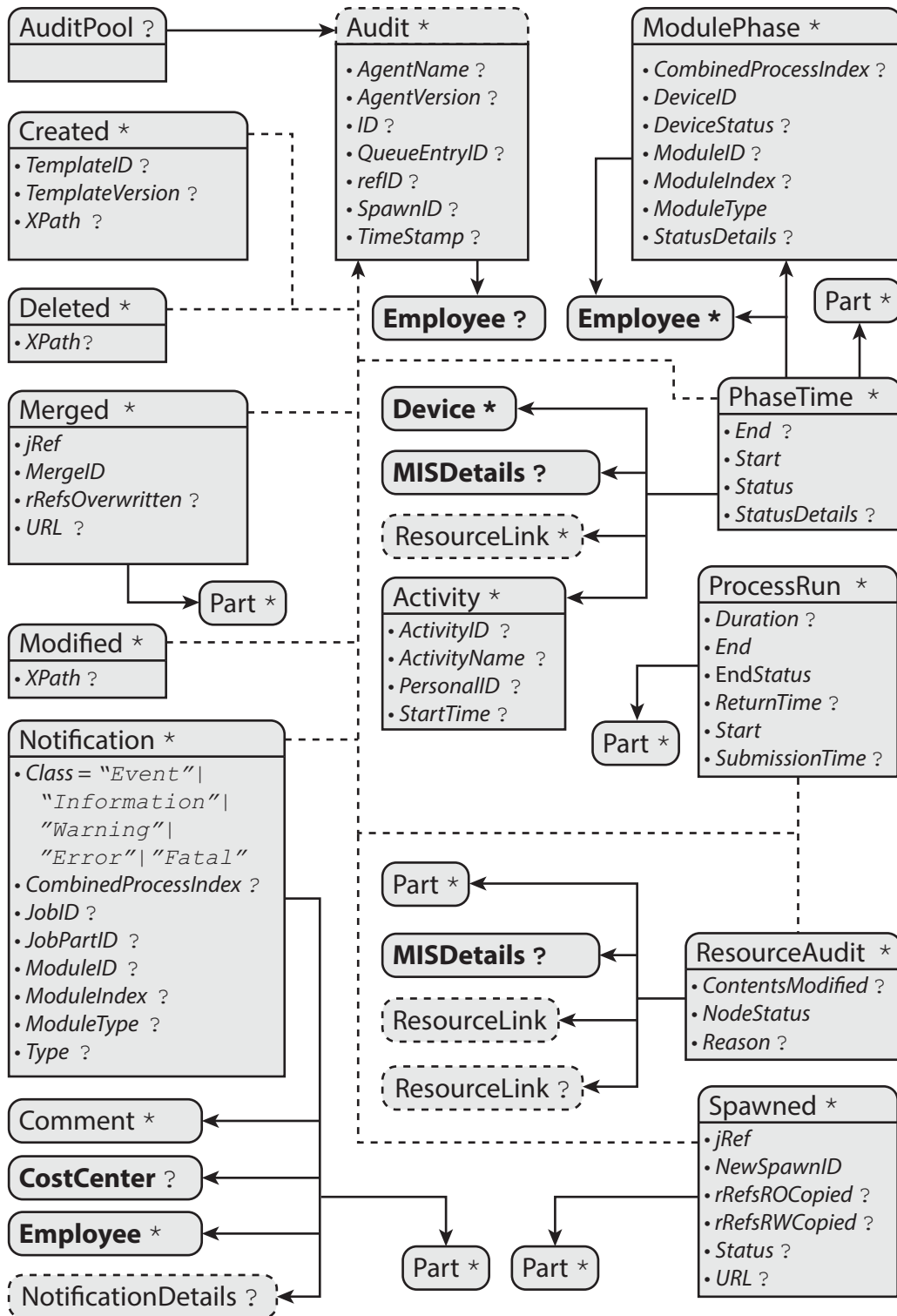

3.11.3 Abstract Audit

All **Audit** elements inherit the content from the **Abstract Audit** element, described in the following table.

Table 3.27: Abstract Audit Element

NAME	DATA TYPE	DESCRIPTION
<i>AgentName</i> ? New in JDF 1.2	string	The name of the agent application that added the Audit element to the AuditPool (and was responsible for the creation or modification). Both the company name and the product name MAY appear, and SHOULD be consistent between versions of the application.
<i>AgentVersion</i> ? New in JDF 1.2	string	The version of the agent application that added the Audit element to the AuditPool (and was responsible for the creation or modification). The format of the version string MAY vary from one application to another, but SHOULD be consistent for an individual application.
<i>Author</i> ? Modified in JDF 1.2 Deprecated in JDF 1.4	string	Text that identifies the person who made the entry. Prior to JDF 1.2, @Author also contained information that is now encoded in @AgentName and @AgentVersion . Deprecation note: Starting with JDF 1.4, use Employee .
<i>ID</i> ? New in JDF 1.2	ID	@ID of the Audit . @ID SHALL be specified if there is support to subsequently create correction Audit elements.
<i>QueueEntryID</i> ? New in JDF 1.4	string	@QueueEntryID of the QueueEntry during which this Audit was generated.
<i>refID</i> ? New in JDF 1.2	IDREF	Reference to a previous Audit that this Audit corrects. The referenced Audit SHALL reside in the same AuditPool .
<i>SpawnID</i> ? New in JDF 1.1	NMTOKEN	Text that identifies the spawned processing step when the entry was generated. This is a copy of the @SpawnID attribute of the root JDF node of the process that generates the Audit at the time the Audit is generated.
<i>TimeStamp</i>	dateTime	For Audit elements Created , Modified , Spawned , Merged and Notification , this attribute records the date and time when the related event occurred. For Audit elements PhaseTime , ProcessRun and ResourceAudit , the attribute describes the time when the entry was appended to the AuditPool .
Employee ? New in JDF 1.4	element	Employee who created this Audit element.

3.11.4 Audit

The following elements are derived from the **Abstract Audit** element:

Table 3.28: List of Audit Elements

NAME	PAGE	DESCRIPTION
Created	page 99	Logs creation of JDF node or resource
Deleted	page 100	Logs deletion of JDF node or resource
Merged	page 100	Logs the merging of a spawned node
Modified	page 100	Logs modifications affecting a JDF node or its subelements when the modification is not covered by other Audit elements
Notification	page 101	Logs individual events that occurred during processing
PhaseTime	page 102	Logs start and end times of any process states and sub-states, denoted as phases. Phases can reflect any arbitrary subdivisions of a process.
ProcessRun	page 105	Summarizes one complete execution run of a node or delimits a group of Audit elements for each individual process run.
ResourceAudit	page 106	Describes the usage of resources during execution of a node or the modification of the intended usage of a resource
Spawned	page 108	Logs the spawning of a node.

Figure 3-15: Specific Audit - a diagram of its structure

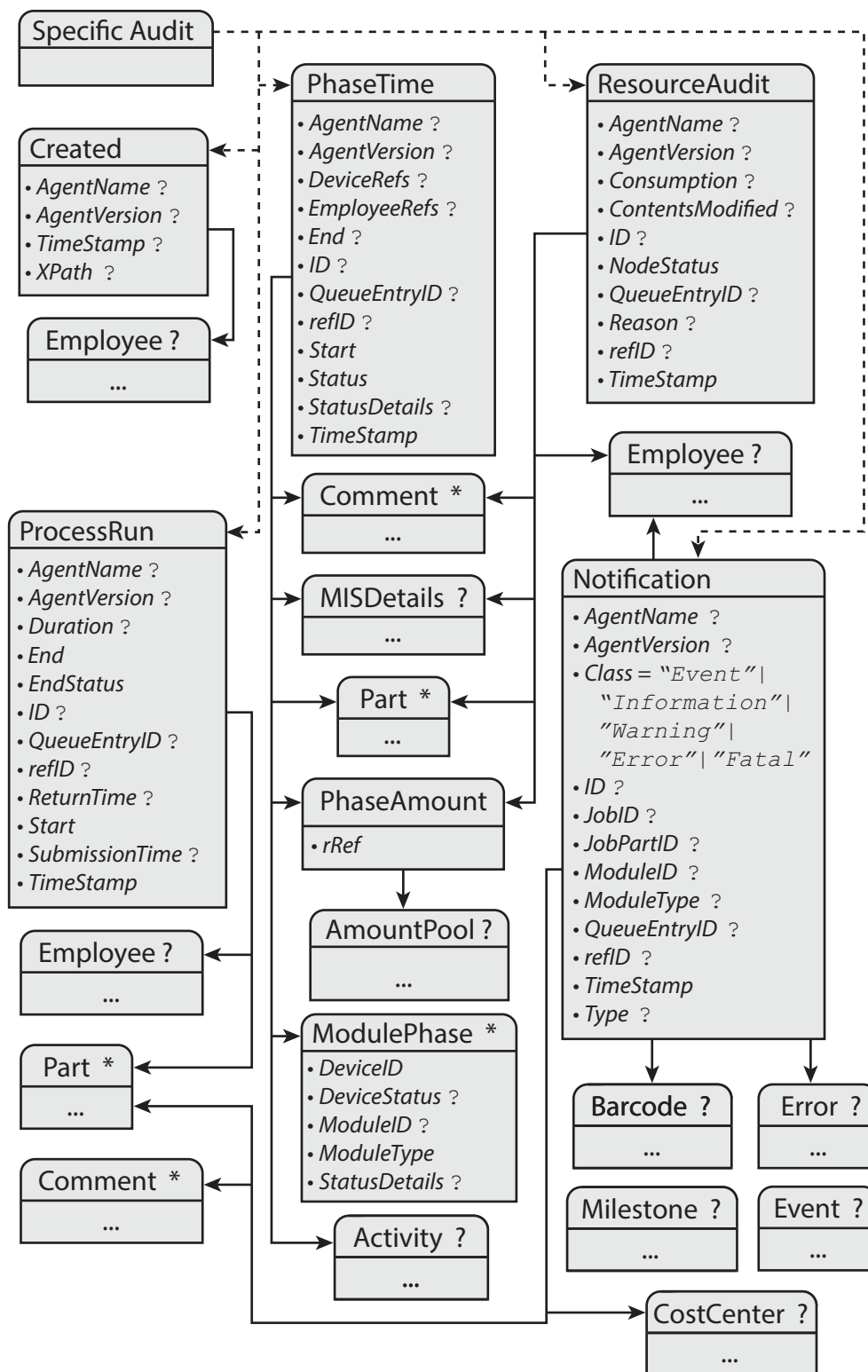

3.11.4.1 Created

This element allows the creation of a **JDF** node or resource to be logged. If the element refers to a **JDF** node, it can be located in the **AuditPool** element of the node that has been created or in any ancestor node. If the element refers to a resource, it SHALL be located in the node where the resource resides so that the spawning and merging mechanism can work effectively.

Table 3.29: Created Audit Element (Sheet 1 of 2)

NAME	DATA TYPE	DESCRIPTION
<i>ref</i> ? Deprecated in JDF 1.2	IDREF	Represents the ID of the created element. Defaults to the ID of the local JDF node. Replaced with @XPath in JDF 1.2 and beyond.

Table 3.29: Created Audit Element (Sheet 2 of 2)

NAME	DATA TYPE	DESCRIPTION
<i>TemplateID</i> ? New in JDF 1.2	string	Defines the template JDF that was used as the template to create the node.
<i>TemplateVersion</i> ? New in JDF 1.2	string	Defines the version of template JDF that was used as the template to create the node.
<i>XPath</i> ? New in JDF 1.2	XPath	Location of the created elements or attributes relative to the parent JDF node of the Created element.

3.11.4.2 Deleted

New in JDF 1.2

This element allows any deletions of a **JDF** node or element to be logged. If the corresponding **Created** element was not deleted (e.g., in the **AuditPool** of a deleted **JDF** node), the **Deleted** element SHOULD reside in the same **AuditPool** as the corresponding **Created** element, otherwise it SHOULD reside in an ancestor of the deleted attribute or element.

Table 3.30: Deleted Audit Element

NAME	DATA TYPE	DESCRIPTION
<i>XPath</i> ?	XPath	Location of the deleted elements or attributes relative to the parent JDF node of the Deleted element.

3.11.4.3 Merged

This element logs a merging event of a spawned node. For more details, see ▶ Section 4.4 Spawning and Merging.

Table 3.31: Merged Audit Element

NAME	DATA TYPE	DESCRIPTION
<i>Independent</i> = "false" Deprecated in JDF 1.5	boolean	Declares that independent jobs are merged into a big job for common production. If it is set to "true", the attributes <i>@jRefSource</i> and <i>@rRefsOverwritten</i> have no meaning and SHOULD be omitted. Deprecation note: Starting with JDF 1.5, use SheetOptimizing .
<i>jRef</i>	IDREF	ID of the JDF node that has been returned or merged.
<i>jRefSource</i> ? Deprecated in JDF 1.5	NMTOKEN	ID of the JDF root node of the big job from which the spawned structure has been returned. Note: The data type is NMTOKEN and not IDREF because the attribute refers to an external ID. Deprecation note: Starting with JDF 1.5, use SheetOptimizing .
<i>MergeID</i> New in JDF 1.1	NMTOKEN	Copy of the <i>@SpawnID</i> of the merged node. Note that a Merged element MAY also contain a <i>@SpawnID</i> attribute, which is the <i>@SpawnID</i> of the node that this Audit is being placed into prior to merging.
<i>rRefsOverwritten</i> ?	IDREFS	Identifies the copied resources that have been overwritten during merging. Resources are usually overwritten during return if they have been copied during spawning with read/write access.
<i>URL</i> ? New in JDF 1.1	URL	Locator that specifies the location of the merged node prior to merging by the merging process.
<i>Part</i> *	element	Specifies the selected parts of the resource that were merged in case of parallel spawning and merging of partitionable resources. See ▶ Section 3.10.5 Description of Partitioned Resources.

3.11.4.4 Modified

This element allows any modifications affecting a **JDF** node or its subelements to be logged. Changes that can be logged by a more specialized **Audit** element (e.g., **ResourceAudit** for resource changes) SHALL NOT use this common log entry.

The modification can be described textually by adding a generic **Comment** element to the **Modified** element. The **Modified** element SHALL reside in the same **AuditPool** as the corresponding **Created** element.

Table 3.32: Modified Audit Element

NAME	DATA TYPE	DESCRIPTION
<i>jRef</i> ? Deprecated in JDF 1.2	IDREF	The ID of the modified node. The Modified element resides in the modified node. Defaults to the ID of the local JDF node. Replaced with @XPath in JDF 1.2 and beyond.
<i>XPath</i> ? New in JDF 1.2	XPath	Location of the modified elements or attributes relative to the parent JDF node of the Modified element.

3.11.4.5 Notification

This element contains information about individual events that occurred during processing. For a detailed discussion of event properties, see ▶ Section 4.6 Error Handling.

Table 3.33: Notification Audit Element (Sheet 1 of 2)

NAME	DATA TYPE	DESCRIPTION
<i>Class</i>	enumeration	Class of the notification. Allowed values are: (in order of severity from lowest to highest): Event – Indicates that a pure event due to certain operation-related activity has occurred (e.g., machine events, operator activities, etc.). This class is used for the transfer of conventional event messages. In case of @Class = "Event" , further event information is to be provided by the @Type attribute and Notification Details element. See ▶ Appendix A.4.14 Notification Details. Information – Any information about a process which cannot be expressed by the other classes (e.g., the beginning of execution). No user interaction is needed. Warning – Indicates that a minor error has occurred, and an automatic fix was applied. Execution continues. The node's @Status is unchanged. This appears in situations such as A4-Letter substitutions when toner is low or when unknown extensions are encountered in a REQUIRED resource. Error – Indicates that an error has occurred that requires user interaction. Execution cannot continue until the problem has been fixed. The node's @Status is "Stopped" . This value appears in situations such as when resources are missing, when major incompatibilities are detected, or when the toner is empty. Fatal – Indicates that a fatal error led to abortion of the process. The node's @Status is "Aborted" . This value is seen with most protocol errors or when major device malfunction has occurred.
<i>CombinedProcessIndex</i> ? New in JDF 1.4	IntegerList	@CombinedProcessIndex attribute specifies the indices of individual processes in the @Types attribute to which a Notification in a combined process node or process group node belongs. Multiple entries in @CombinedProcessIndex specify that the module specified by Notification is executing the respective multiple processes in the combined process node.
<i>JobID</i> ? New in JDF 1.3	string	@JobID that this Notification applies to. @JobID SHALL NOT be specified when Notification is used as an Audit element. Notification/@JobID MAY be specified within a JMF message.
<i>JobPartID</i> ? New in JDF 1.3	string	@JobPartID that this Notification applies to. @JobPartID SHALL NOT be specified when Notification is used as an Audit element. Notification/@JobPartID MAY be specified within a JMF message.
<i>ModuleID</i> ? New in JDF 1.4	string	@ModuleID of the Module that this Notification relates to.
<i>ModuleIndex</i> ? New in JDF 1.4	IntegerRangeList	0-based indices of the module or modules. The list is based on all modules of the device. If multiple module types are available on one device, each SHALL be unique in the scope of the device. Constraint: At least one of @ModuleID or @ModuleIndex SHALL be specified.

Table 3.33: Notification Audit Element (Sheet 2 of 2)

NAME	DATA TYPE	DESCRIPTION
<i>ModuleType</i> ? New in JDF 1.4	NMTOKEN	Module description. Values include those from: ▶ Module Types. Note: The allowed values depend on the type of device. Each type of device has a separate table of values.
<i>Type</i> ?	NMTOKEN	Identifies the type of notification. Also defines the name of the Notification Details element. Note: @Type allows parsers that do not have access to the schema to find the instance of Notification Details . Values include those from: ▶ Notification Details.
Comment *	element	A Comment element contains a verbose, human-readable description of the event. If the value of the @Class attribute is one of "Information", "Warning", "Error" or "Fatal", at least one Comment element SHOULD be specified. Otherwise (including for @Class = "Event"), Comment elements are OPTIONAL.
CostCenter ?	element	The cost center to which this event is related to.
Employee *	refelement	The employees associated with this event.
Notification Details ?	element	Notification Details is an abstract element that is a placeholder for additional structured information. It provides additional information beyond the @Class and @Type attribute and beyond the Comment element. See ▶ Appendix A.4.14 Notification Details. For derived elements see ▶ Appendix A.4.14.2 Notification Details.
Part * New in JDF 1.1	element	Describes which parts of a process this Notification belongs to. If Part is not specified for a Notification , it refers to all parts. For example, imagine a print job that is to produce three different sheets. All sheets are described by one partitioned resource. The Part elements define, unambiguously, the sheet to which the Audit refers.

3.11.4.6 PhaseTime

This element contains audit information about the start and end times of any process states and sub-states, denoted as phases. Phases can reflect any arbitrary subdivisions of a process, such as maintenance, washing, plate changing, failures and breaks. **PhaseTime** elements SHOULD be closed whenever a significant status change that is detected.

PhaseTime elements MAY also be used to log the actual time spans when **ImplementationResources** are used by a process. For example, the temporary usage of a fork lift can be logged if a **PhaseTime** element is added that contains a link to the fork lift device resource and specifies the actual start and end time of the usage of that fork lift.

PhaseTime elements that apply to identical partitions and contain at least one identical **ModulePhase** SHALL NOT overlap in time. **PhaseTime** elements that apply to different partitions MAY overlap in time in order to indicate parallel processing. **PhaseTime** elements that apply to different modules MAY overlap in time in order to indicate independent processing with individual modules.

Table 3.34: PhaseTime Audit Element (Sheet 1 of 2)

NAME	DATA TYPE	DESCRIPTION
<i>End</i> ? Modified in JDF 1.3	dateTime	Date and time of the end of the phase. If not specified, the PhaseTime is ongoing and the end of the phase has not yet occurred. This will generally be the case in the last PhaseTime of a snapshot JDF in a status JMF . See ▶ Section 5.55 Status for details.,
<i>Start</i>	dateTime	Date and time of the beginning of the phase.

Table 3.34: PhaseTime Audit Element (Sheet 2 of 2)

NAME	DATA TYPE	DESCRIPTION
<i>Status</i> Modified in JDF 1.3	enumeration	Status of the phase. Allowed values are: (a subset of <i>JDF/@Status</i>) <i>TestRunInProgress</i> <i>Setup</i> <i>InProgress</i> <i>Cleanup</i> <i>Spawned</i> – Deprecated in JDF 1.3 <i>Suspended</i> – New in JDF 1.3 <i>Stopped</i> Note: The values of this <i>@Status</i> attribute are a subset of the possible state values <i>JDF/@Status</i> . For all possible states of a JDF node see ▶ Table 3.4 JDF. The remaining set of states (i.e., " <i>Ready</i> ", " <i>FailedTestRun</i> ", " <i>Aborted</i> " and " <i>Completed</i> ") are end states and are specified in <i>ProcessRun/@EndStatus</i> .
<i>StatusDetails</i> ?	string	Description of the status phase that provides details beyond the enumerative values given by the <i>@Status</i> attribute. Values include those from: ▶ Status Details.
<i>Activity</i> * New in JDF 1.5	element	Operator and device activities that are related to a specific job or job phase.
<i>Device</i> *	refelement	Links to <i>Device</i> resources that are working during this phase. If one or more <i>Device</i> resource(s) was used during this phase, this reelement SHOULD link to that/those <i>Device</i> resource(s)
<i>Employee</i> *	refelement	Links to <i>Employee</i> resources that are working during this phase. If one or more <i>Employee</i> resources was active during this phase, this reelement SHOULD link to that/those <i>Employee</i> resource(s). The first employee referenced in this list is the employee who created this <i>Audit PhaseTime</i> element.
<i>MISDetails</i> ? New in JDF 1.2	element	Definition how the costs for the execution of this <i>PhaseTime</i> are to be charged.
<i>ModulePhase</i> *	element	Additional phase information of individual device modules, such as print units.
<i>Part</i> *	element	Describes which parts of a job is currently being logged. If a <i>Part</i> is not specified for a node that modifies partitioned resources, <i>@PhaseTime</i> refers to all parts. For example, imagine a print job that is to produce three different sheets. All sheets are described by one partitioned resource. In order to separate the different print phases for each sheet, the <i>Part</i> elements define, unambiguously, the sheet to which the <i>Audit PhaseTime</i> refers.
<i>ResourceLink</i> * New in JDF 1.1	element	These <i>ResourceLink</i> elements specify the actual consumption/usage or production of resources during this production phase. All attributes apply to production and consumption within this <i>PhaseTime</i> only, thus <i>ResourceLink/@ActualAmount</i> specifies the actual amount produced or consumed.

3.11.4.6.1 Activity

New in JDF 1.5

Activity elements allow tracking of device and operator tasks.

Table 3.35: Activity Element (Sheet 1 of 2)

NAME	DATA TYPE	DESCRIPTION
<i>ActivityID</i> ?	string	ID of the activity being performed. This ID is unique, site specific and internal to the MIS.
<i>ActivityName</i> ?	string	Name of the activity being performed.
<i>PersonalID</i> ?	string	ID of the employee that performs the activity. This value SHALL match the <i>@PersonalID</i> of an <i>Employee</i> element that is contained in the <i>Activity</i> element's parent or ancestor element.

Table 3.35: Activity Element (Sheet 2 of 2)

NAME	DATA TYPE	DESCRIPTION
<i>StartTime</i> ?	dateTime	Date and time that the employee started the activity. This value MAY remain the same in multiple messages.

3.11.4.6.2 ModulePhase

It is possible to monitor the states of individual modules of a complex device, such as a press with multiple print units, by defining *ModulePhase* elements. One *PhaseTime* element MAY contain multiple *ModulePhase* elements and can, therefore, record the status of multiple units in a device. *ModulePhase* elements describe the set of modules that a given *PhaseTime* audit element applies to. *ModulePhase* elements are defined in the following table.

Table 3.36: ModulePhase Element (Sheet 1 of 2)

NAME	DATA TYPE	DESCRIPTION
<i>CombinedProcessIndex</i> ? New in JDF 1.3	IntegerList	@ <i>CombinedProcessIndex</i> attribute specifies the indices of individual processes in the @ <i>Types</i> attribute to which a <i>ModulePhase</i> in a combined process node or process group node belongs. Multiple entries in @ <i>CombinedProcessIndex</i> specify that the module specified by <i>ModulePhase</i> is executing the respective multiple processes in the combined process node.
<i>DeviceID</i>	string	ID of the device that the module described by this <i>ModulePhase</i> belongs to. This SHALL be the @ <i>DeviceID</i> attribute of one of the <i>Device</i> elements specified in the <i>PhaseTime</i> .
<i>DeviceStatus</i> ? Modified in JDF 1.3	enumeration	Status of the device module. Allowed values are: <i>Unknown</i> . – The module status is unknown. <i>Idle</i> – The module is not used (e.g., a color print module that is inactive during a black-and-white print). <i>Down</i> – The module cannot be used. It might be broken, switched off etc. <i>Setup</i> – The module is currently being set up. <i>Running</i> – The module is currently executing. <i>Cleanup</i> – The module is currently being cleaned. <i>Stopped</i> – The module has been stopped, but running might be resumed later. This status can indicate any kind of break, including a pause, maintenance or a breakdown, as long as running can be easily resumed. Note: These states are analog to the device states of ▶ Table 5.105 <i>ModuleStatus</i> Element.
<i>End</i> ? Modified in JDF 1.3 Deprecated in JDF 1.4	dateTime	Date and time of the end of the module phase. If not specified, the <i>ModulePhase</i> is ongoing and the end of the phase has not yet occurred. Deprecation note: Starting with JDF 1.4, all status information is recorded in <i>PhaseTime</i> . <i>ModulePhase</i> selects only the set of modules that a particular <i>PhaseTime</i> applies to.
<i>ModuleID</i> ? New in JDF 1.3	string	@ <i>ModuleID</i> of the module that this <i>ModulePhase</i> refers to. If not specified, the module is specified in @ <i>ModuleIndex</i> . Constraint: at least one of @ <i>ModuleID</i> or @ <i>ModuleIndex</i> SHALL be specified.
<i>ModuleIndex</i> ? Modified in JDF 1.3	IntegerRangeList	0-based indices of the module or modules. The list is based on all modules of the device. If multiple module types are available on one device, each SHALL be unique in the scope of the device. Constraint: At least one of @ <i>ModuleID</i> or @ <i>ModuleIndex</i> SHALL be specified.
<i>ModuleType</i> ? Modified in JDF 1.5	NMTOKEN	Module description. Values include those from: ▶ <i>ModuleTypes</i> . Note: The allowed values depend on the type of device. Each type of device has a separate table of values. Modification note: Starting with JDF 1.5, @ <i>ModuleType</i> is optional.
<i>Start</i> Modified in JDF 1.3 Deprecated in JDF 1.4	dateTime	Date and time of the beginning of the module phase. Deprecation note: Starting with JDF 1.4, all status information is recorded in <i>PhaseTime</i> . <i>ModulePhase</i> selects only the set of modules that a particular <i>PhaseTime</i> applies to.

Table 3.36: ModulePhase Element (Sheet 2 of 2)

NAME	DATA TYPE	DESCRIPTION
<i>StatusDetails</i> ?	string	Description of the module status phase that provides details beyond the enumerative values given by the <i>@DeviceStatus</i> attribute. Values include those from: ▶ Status Details.
<i>Employee</i> * Deprecated in JDF 1.5	reference	References to <i>Employee</i> resources that are working during this module phase on this module. (The module is specified by the attributes <i>@ModuleIndex</i> and <i>@ModuleType</i>). Deprecation note: Starting with JDF 1.5, employees SHOULD only be specified in the parent <i>PhaseTime</i> .

3.11.4.7 ProcessRun

This *Audit* element serves two related functions.

The first function is to summarize one complete execution run of a node. It contains attributes that record the date and time of the start, the end time, the final process state when the run is finished and, possibly, the process duration of the process run. These attributes are described in ▶ Table 3.37 ProcessRun Audit Element.

The second function is to delimit a group of *Audit* elements for each individual process run. Every group of *Audit* elements terminates with a *ProcessRun* element, which contains the information described in ▶ Table 3.37 ProcessRun Audit Element. If a process is repeated (e.g., as a result of a late change in the order), all *Audit* elements belonging to the new run SHALL be appended after the last *ProcessRun* element that terminates the *Audit* elements of the previous run. The number of *ProcessRun* elements is, therefore, always equivalent to the number of process runs. If a node describes partitioned resources, one *ProcessRun* MAY be specified for each individual part.

Table 3.37: ProcessRun Audit Element

NAME	DATA TYPE	DESCRIPTION
<i>Duration</i> ?	duration	Time span of the effective process runtime without intentional or unintentional breaks. That time span is the sum of all process phases when the <i>@Status</i> is "InProgress", "Setup" or "Cleanup".
<i>End</i>	dateTime	Date and time at which the process ended.
<i>EndStatus</i> Modified in JDF 1.3	enumeration	The <i>@Status</i> of the process at the end of the run. For a description of process states, see ▶ Table 3.4 JDF. Allowed values are: <i>Aborted</i> <i>Completed</i> <i>FailedTestRun</i> <i>Ready</i> <i>Stopped</i> . – The execution of the node is stopped and might commence at a later time. In JDF 1.3 and beyond, "Stopped" is not an end state. Deprecated in JDF 1.3
<i>ReturnTime</i> ? New in JDF 1.4	dateTime	Date and time of the <i>ReturnQueueEntry</i> submission. If the JDF was returned via a Hot Folder, this time corresponds to the time when the JDF was placed into the Hot Folder.
<i>Start</i>	dateTime	Date and time at which the process started.
<i>SubmissionTime</i> ? New in JDF 1.4	dateTime	Date and time of the <i>SubmitQueueEntry</i> submission. This value SHOULD be identical with <i>QueueEntry/@SubmissionTime</i> . If the JDF was submitted via a Hot Folder, this time corresponds to the time when the JDF was extracted from the Hot Folder.
<i>Part</i> * New in JDF 1.1	element	Describes which parts of a process this <i>ProcessRun</i> belongs to. If <i>Part</i> is not specified for a <i>ProcessRun</i> , it refers to all parts. For example, imagine a print job that is to produce three different sheets. All sheets are described by one partitioned resource. The <i>Part</i> elements define, unambiguously, the processing of the sheet to which the <i>ProcessRun</i> refers.

3.11.4.8 ResourceAudit

The **ResourceAudit** element describes the usage of resources during execution of a node or the modification of the intended usage of a resource (i.e., the modification of a **ResourceLink**). It logs consumption and production amounts of any quantifiable resources, accumulated over one process run or one part of a process run. It contains one or two abstract **ResourceLink** elements. The first is **REQUIRED** and specifies the actual consumption/usage or production of the resource. The second **ResourceLink** is **OPTIONAL** and used to store information about the original **ResourceLink**, which also refers to the original resource. If the original resource does not need to be saved, a Boolean **@ContentsModified** attribute in the **ResourceAudit** SHOULD be specified as "true" to indicate that a change has been made.

Table 3.38: ResourceAudit Audit Element

NAME	DATA TYPE	DESCRIPTION
ContentsModified ?	boolean	Specifies that a modification has occurred but that the original resource has been deleted.
NodeStatus ? New in JDF 1.3	enumeration	Status of the node that was executed during production or consumption of the resource. Allowed values are: TestRunInProgress Setup InProgress Cleanup Suspended Stopped Note: The above values are a subset of ▶ Status and thus are a subset of the possible state values JDF/@Status . For all possible states of a JDF node see ▶ Table 3.4 JDF. The remaining set of states (i.e., "Ready", "FailedTestRun", "Aborted" and "Completed") are end states and are specified in ProcessRun/@EndStatus .
Reason ? New in JDF 1.1	enumeration	Reason for the modification. Allowed values are: OperatorInput – Human update that corrects inconsistencies from automated data collection. PlanChange – The resource was modified due to a change of plan before actual processing. ProcessResult – The actual consumption.
MISDetails ? New in JDF 1.3	element	Specifies how the costs associated with this ResourceAudit are to be charged.
Part *	element	Describes which parts of a job is currently being logged. If a part is not specified for a node that modifies partitioned resources, ResourceAudit refers to all parts.
ResourceLink	element	The first ResourceLink specifies the actual consumption/usage or production of a resource. This current resource after modification NEED NOT be set to @Locked="true" .
ResourceLink ?	element	The second ResourceLink , which is OPTIONAL , logs the modification of a ResourceLink and the modification of the resource it refers to. It holds the planned ResourceLink which also refers to the planned resource. The planned and actual resource MAY be the same.

For details on **ResourceLink** elements and **ResourceLink** Subclasses, see ▶ Section 3.9 ResourceLinkPool and ResourceLink. The partitioning of resources using **Part** elements is defined in ▶ Section 3.10.5 Description of Partitioned Resources.

3.11.4.8.1 Logging Machine Data by Using the ResourceAudit

If a resource is modified during processing, any nodes that also reference the resource MAY also be affected. The following logging procedure is RECOMMENDED in order to track the resource modification and to insure consistency of the job.

- 1 Create a copy of the original resource with a new ID.
- 2 Modify the original resource to reflect the changes.
- 3 Insert a **ResourceAudit** element that references the modified original resource with the first **ResourceLink** and the copied resource with the second **ResourceLink** attribute

Example 3.34: ResourceAudit: Before Logging

The following example describes the logging of a modification of the media weight and amount. The **JDF** document before modification requests 400 copies of 80 gram media.

```
<JDF ID="J1" JobPartID="ID234" Status="Waiting"
  Type="ConventionalPrinting" Version="1.6" xmlns="http://www.CIP4.org/JDFSchema_1_1">
  <ResourceLinkPool>
    <MediaLink Amount="400" Usage="Input" rRef="RLink"/>
    <ConventionalPrintingParamsLink Usage="Input" rRef="R01"/>
    <ComponentLink Usage="Output" rRef="R02"/>
  </ResourceLinkPool>
  <ResourcePool>
    <Media Amount="400" Class="Consumable" ID="RLink" Status="Available" Weight="80"/>
    <ConventionalPrintingParams Class="Parameter" ID="R01" Status="Available"/>
    <Component Class="Quantity" ComponentType="Sheet" ID="R02" Status="Unavailable"/>
  </ResourcePool>
</JDF>
```

Example 3.35: ResourceAudit: Logging of Consumption

The **JDF** after modification specifies that 421 copies of 90-gram media have been consumed.

```
<JDF ID="J1" JobPartID="ID234" Status="Waiting"
  Type="ConventionalPrinting" Version="1.6" xmlns="http://www.CIP4.org/JDFSchema_1_1">
  <ResourceLinkPool>
    <!-- Note that ActualAmount has been added to the ResourceLink -->
    <MediaLink ActualAmount="421" Amount="400" Usage="Input" rRef="RLink"/>
    <ConventionalPrintingParamsLink Usage="Input" rRef="R01"/>
    <ComponentLink Usage="Output" rRef="R02"/>
  </ResourceLinkPool>
  <ResourcePool>
    <Media Amount="400" Class="Consumable" ID="RPrev" Status="Available" Weight="80"/>
    <!--Copy of the original resource-->
    <Media Amount="421" Class="Consumable" ID="RLink" Status="Available" Weight="90"/>
    <ConventionalPrintingParams Class="Parameter" ID="R01" Status="Available"/>
    <Component Class="Quantity" ComponentType="Sheet" ID="R02" Status="Unavailable"/>
    <!--modified resource-->
  </ResourcePool>
  <AuditPool>
    <ResourceAudit TimeStamp="2008-08-28T18:20:00Z">
      <MediaLink ActualAmount="421" Amount="400" Usage="Input" rRef="RLink"/>
      <MediaLink Amount="400" Usage="Input" rRef="RPrev"/>
    </ResourceAudit>
  </AuditPool>
</JDF>
```

3.11.4.8.2 Logging Changes in Product Descriptions by Using the ResourceAudit

ResourceAudit elements MAY also be used to store the original **Intent Resource** of a product specification in a change order or request for quote. The mechanism is the same as above.

Example 3.36: ResourceAudit: Logging Changes

The following example shows the structure of a **MediaIntent** with **@Option** partitions, where a late change of options from Option1 (80 gram paper) to Option2 (90 gram paper) is requested.

```
<JDF ID="J1" JobPartID="ID234" Status="Waiting" Type="Product"
  Version="1.6" xmlns="http://www.CIP4.org/JDFSchema_1_1">
  <ResourceLinkPool>
    <MediaIntentLink Usage="Input" rRef="id">
      <Part Option="Option2"/>
    </MediaIntentLink>
    <ComponentLink Usage="Output" rRef="R02"/>
  </ResourceLinkPool>
  <ResourcePool>
    <MediaIntent ID="id" PartIDKeys="Option">
      <!-- the common MediaIntent resource details -->
      <MediaIntent Option="Option1">
        <Weight DataType="NumberSpan" Preferred="80"/>
      </MediaIntent>
      <MediaIntent Option="Option2">
        <Weight DataType="NumberSpan" Preferred="90"/>
      </MediaIntent>
    </MediaIntent>
    <Component Class="Quantity" ComponentType="Sheet" ID="R02" Status="Unavailable"/>
  </ResourcePool>
  <AuditPool>
    <ResourceAudit>
      <!-- the actual MediaIntent ResourceLink -->
      <MediaIntentLink Usage="Input" rRef="id">
        <Part Option="Option2"/>
      </MediaIntentLink>
      <!-- the original MediaIntent ResourceLink -->
      <MediaIntentLink Usage="Input" rRef="id">
        <Part Option="Option1"/>
      </MediaIntentLink>
    </ResourceAudit>
  </AuditPool>
</JDF>
```

3.11.4.9 Spawned

This element allows a node that has been spawned to be logged in the **AuditPool** of the parent node of the spawned node or in the **AuditPool** of the node that has been spawned in case of spawning of individual partitions. For details about spawning and merging, see ▶ Section 4.4 Spawning and Merging.

Table 3.39: Spawned Audit Element (Sheet 1 of 2)

NAME	DATA TYPE	DESCRIPTION
<i>Independent</i> = "false" ? Deprecated in JDF 1.5	boolean	Declares that independent jobs that have previously been merged into a big job are spawned. If it is set to "true", the attributes <i>@jRefDestination</i> , <i>@rRefsROCopied</i> and <i>@rRefsRWCopied</i> have no meaning and SHOULD be omitted. Deprecation note: Starting with JDF 1.5 , use SheetOptimizing .
<i>jRef</i>	IDREF	ID of the JDF node that has been spawned.
<i>jRefDestination</i> ? Deprecated in JDF 1.5	NMTOKEN	ID of the JDF node to which the job has been spawned. This attribute SHALL be specified in the parent of the original node if independent jobs are spawned. Note: The data type is NMTOKEN and not IDREF because the attribute refers to an external ID. Deprecation note: Starting with JDF 1.5 , use SheetOptimizing .
<i>NewSpawnID</i> New in JDF 1.1	NMTOKEN	Copy of the <i>@SpawnID</i> of the newly spawned node. Note that a spawned Audit MAY also contain a <i>@SpawnID</i> attribute, which is the <i>@SpawnID</i> of the node that this Audit is being placed into prior to spawning.

Table 3.39: Spawned Audit Element (Sheet 2 of 2)

NAME	DATA TYPE	DESCRIPTION
<i>rRefsROCopied</i> ?	IDREFS	List of IDs separated by whitespace. Identifies the resources copied to the ResourcePool element of the spawned JDF during spawning. These resources SHOULD NOT be modified by the spawned JDF .
<i>rRefsRWCopied</i> ?	IDREFS	List of IDs separated by white spaces. Identifies the resources copied to the ResourcePool element of the spawned JDF during spawning. These resources MAY be modified by the spawned JDF and SHALL be copied back into their original location by the merging agent. Resource copying is REQUIRED if resources are referenced simultaneously from spawned nodes and from nodes in the original JDF document.
<i>Status</i> ? New in JDF 1.1	enumeration	Status of the spawned node at the time of spawning. Allowed values are from: ▶ Status.
<i>URL</i> ? New in JDF 1.1	URL	Locator that specifies the location where the spawned node was stored by the spawning process.
<i>Part</i> *	element	Identifies the parts that were selected for spawning in case of parallel spawning of partitionable resources. See ▶ Section 3.10.5 Description of Partitioned Resources.

3.12 JDF Extensibility

JDF is meant to be flexible and therefore useful to any vendor, as each vendor may have specific data to include in the **JDF** files. This section describes how **JDF** uses the XML extension mechanisms.

3.12.1 Namespaces in XML

JDF extensibility is implemented using XML Namespaces ▶ [XMLNS]. XML namespaces are defined by @*xmlns* attributes. A general example is provided below.

Namespaces are inserted in front of attribute and element names. The associated namespace of element names with no prefix is the default namespace defined by the *xmlns* attribute. The associated namespace of attributes with no prefix is that one of the element. All namespace prefixes SHALL be declared using the standard @*xmlns*:prefix attribute declarations.



Using Namespaces in JDF

It is REQUIRED to define the JDF namespace in a JDF document, even if no non JDF extensions are used. JDF can be defined either in the default namespace or in a qualified namespace.

Example 3.37: Namespaces in XML

The example illustrates how private namespaces are declared and used to extend an existing **JDF** resource by adding private attributes and a private element.

```
<JDF ID="ID1" JobPartID="ID345" Status="Ready" Type="Product"
  Version="1.6" xmlns="http://www.CIP4.org/JDFSchema_1_1" xmlns:foo="fooschema_URI">
  <!-- ... -->
  <ResourcePool>
    <!-- Extending Device Resource ... -->
    <Device Class="Implementation" ID="SomeID" ModelName="abc"
      Status="Available" foo:specialname="cba">
      <!-- ... -->
      <foo:PrivateStuff type="privatetype"/>
      <!-- ... -->
    </Device>
    <!-- ... -->
  </ResourcePool>
</JDF>
```

3.12.1.1 JDF Namespace

The official namespace URI for **JDF** Version 1.0 is: http://www.CIP4.org/JDFSchema_1. The official namespace URI for **JDF** Version 1.1 through **JDF** 1.X is: http://www.CIP4.org/JDFSchema_1_1. It is strongly RECOMMENDED to use either the default namespace with no prefix or a prefix of “jdf” as the **JDF** namespace prefix.

3.12.1.2 JDF Extension Namespace

CIP4 defines an extension namespace where new features that are anticipated to be included in a future version of the specification are defined. The official extension namespace URI for **JDF** Version 1.x is: http://www.CIP4.org/JDFSchema_1_1_X. It is strongly RECOMMENDED to use a prefix of “jdfx” as the **JDF** extension namespace prefix.

3.12.2 Creating Extension Intent Elements

New intent elements may be defined by creating an intent with `@Name` referring to a proprietary xml namespace. The extension element SHALL reside in the intent element.

Example 3.38: Creating Extension Intent elements

```
<ResourcePool>
  <foo:BarIntentroduct xmlns:foo="www.foo.com" attrib="myAttrib"/>
</ResourcePool>
```

3.12.3 Extending Process Types

JDF defines a basic set of process types. However, because **JDF** allows flexible encoding, this list, by definition, will not be complete. Vendors that have specific processes that do not fit in the general **JDF** processes and that are not combinations of individual **JDF** processes (see ▶ Section 3.3.3 Combined Process Nodes) can create **JDF** process nodes of their own type. Then the content of the `@Type` attribute MAY be specified with a prefix that identifies the organization. The prefix and name SHALL be separated by a single colon (:) as shown in the following example.

Example 3.39: Extending Process Types

```
<JDF ID="ID1" JobPartID="ID345" Status="Ready"
  Type="myCompaniesNS:MyVeryImportantProcess" Version="1.6"
  xmlns="http://www.CIP4.org/JDFSchema_1_1" xmlns:myCompaniesNS="my_companies_namespace_URI">
  <!-- ... -->
</JDF>
```

3.12.3.1 Rules about Process Extension

The use of namespace prefixes in the `@Type` attribute is for extensions only. Standard **JDF** process types SHALL be specified without a prefix in the `@Type` attribute or the `@Types` attribute of a combined process node. If a process is simply an extension of an existing process, it is possible to describe the private data by extending the existing resource types. This is described in greater detail in the sections below.



Extensibility Caution

JDF “Extensibility” simply means that you can add your own XML elements, attributes and enumerations to a **JDF** application. Although **JDF** is quite extensive, odds are you’ll find that your current databases and workflow systems use information elements that are unique to your client market or company ... *they might have even been defined by your internal MIS staff*. CIP4 acknowledges that it can’t define everything, nor ought it prevent innovation by codifying everything in a static manner, and **JDF**’s extensibility provides both printers and technology providers with the flexibility they need to make **JDF** a success. However, if you or your technology vendors extend **JDF**, please do so with caution. **JDF**’s success depends on the ability of MIS systems and **JDF** enabled devices to write, read, parse and use **JDF**. Extensions are *custom* integration applications and great care needs to be made to ensure that extensions made for one systems or device will not *jam* the **JDF** workflow or other **JDF** enabled systems and devices. If they use extensions to **JDF**, your technology providers need to be able to provide you with a fully validated **JDF** schema and documentation that includes the use of their extensions. Extensions that are not documented, or that are not to be disclosed to third parties for integration purposes, ought to be viewed skeptically.

3.12.4 Extending the NodeInfo and CustomerInfo Nodes

Extending the `NodeInfo` and `CustomerInfo` nodes is achieved in a manner analogous to the extension of resources, which is described below. On the other hand, extending the direct contents of **JDF** nodes by adding new elements or attributes is discouraged.

3.12.5 Extending Existing Resources

All resources defined by **JDF** MAY be extended by adding attributes and elements using one’s own namespace for these resource extensions. This is useful when the predefined resource types need only a small amount of private data added,

or if those resources are the only appropriate place to put the data. The **JDF** namespace of the extended resource SHALL NOT be modified. However, the mechanism for creating new resources in a separate namespace is provided in the next section.

However, duplicate functionality SHALL NOT be added to these resource types. **JDF** defined attributes and elements SHALL be used where possible and MAY be extended with additional information only when **JDF** defined constructs don't exist. For example, it is not allowed to extend the RIP resource that controls the bits per colorant with a `@foo:ColorantDepth` or `@foo:ColDepth` attribute that overrides the **JDF** defined parameter for bits per colorant (see [RenderingParams/@ColorantDepth](#) in ▶ Section 8.126 RenderingParams).

3.12.6 Extending NMTOKEN Lists

Many resources contain attributes of type NMTOKEN. Some of these have a set of predefined, suggested enumerative values. These lists MAY be extended with private keywords. In order to identify private keywords, it is strongly RECOMMENDED to prefix these keywords with a namespace like syntax (i.e., a namespace prefix separated by a single colon ":"). Such a namespace prefix SHOULD be defined in the **JDF** ticket with the standard `xmlns:Prefix="someURI"` notation, even if no extension elements or attributes from that namespace occur in the **JDF** ticket. Implementations that find an unknown NMTOKEN prefixed by a namespace prefix MAY then attempt to use the default value of that attribute if the value of `@SettingsPolicy` in effect is "BestEffort".

Example 3.40: Extending NMTOKEN Lists

For instance, if an implementation encounters `TrappingParams/@TrapEndStyle` (see below in ▶ Table 3.40 Excerpt from TrappingParams) in the **JDF** snippet shown below, and if the implementation does not support the "HDM" extension, the best assumption is to use `@TrapEndStyle = "Miter"`, which is the default for `@TrapEndStyle`.

```
<TrappingParams TrapEndStyle="HDM:FooBar"/>
```

Table 3.40: Excerpt from TrappingParams

NAME	DATA TYPE	DESCRIPTION
<code>TrapEndStyle = "Miter"</code>	NMTOKEN	Instructs the trap engine how to form the end of a trap that touches another object. Values include: <code>Miter</code> <code>Overlap</code> Note: Other values might be added later as a result of customer requests.

3.12.7 Creating New Resources

There are certain process implementations that have functionality that cannot be specified by the predefined resource types. In these cases, it might be necessary to create a new resource-type element. If so, the resource SHALL be clearly specified and use its own namespace. These resource types SHALL only be linked to custom-type **JDF** process nodes.

3.12.8 Future JDF Extensions

In future versions, certain private extensions will become more widely used, even by different vendors. As private extensions become more of a general rule, those extensions will be candidates for inclusion in the next version of the **JDF** specification. At that time the specific extensions will have to be described and will be included into the **JDF** namespace.

3.12.9 Maintaining Extensions

Given the mix of vendors that will use **JDF**, it is likely that there will be a number of private extensions. Therefore, **JDF** controllers SHALL be prepared to receive **JDF** files that have extensions. These controllers SHOULD ignore all extensions they don't understand, but under no circumstance are they allowed to remove these extensions when making modifications to the **JDF**. If they do, it will break the extensibility mechanism. For example, imagine that **JDF** agent A creates a **JDF** and inserts private information for process P. Furthermore, the information is only understood by agent A and the appropriate device D for executing P. If the **JDF** needs to be processed first by another agent/Device C and that process



Submit Your Extensions to CIP4

Writing JDF extensions? CIP4 encourages you to become part of the standard and submit your private extensions for review and possible inclusion in future versions of the JDF standard. Not only might adoption of extensions into the JDF standard help make it easier for customers to decide to buy your products, but CIP4 is also considering adopting a formal review process for extensions with future editions of the JDF standard. By participating in JDF's development now, you could save time and help avoid customer confusion in the future.

STRUCTURE

removes all private data for P, process P will not be able to produce the correct results on device D that were specified by agent A.

3.12.10 Processing Unknown Extensions

If a node is processed by a controller or device and it encounters an unknown extension in one of its input resources, the expected behavior depends on the current value of `@SettingsPolicy`.

If `@SettingsPolicy = "BestEffort"`, a **Notification** audit element with `@Class = "Warning"` SHOULD be logged.

If `@SettingsPolicy = "MustHonor"`, the process SHALL NOT continue and a **Notification** audit element with `@Class = "Error"` SHOULD be logged.

If `@SettingsPolicy = "OperatorIntervention"`, the process SHALL stop and wait for an operator intervention and a **Notification** audit element with `@Class = "Warning"` SHOULD be logged.

3.12.11 Derivation of Types in XML Schema

The XML Schema definition, see ▶ [XMLSchema](part 1), describes a mechanism to create new types by derivation from other types. This is an alternative to extend or create new elements as described in, ▶ [XMLSchema](part 1, section 4). This mechanism is not allowed to be applied to any elements defined by **JDF** because such new element types can only be understood by agents/Devices that know the extension. The use of the derivation mechanism is allowed only for private extensions.

3.13 JDF Versioning

New in JDF 1.2

The **JDF** Specification is an evolving document that exists in multiple versions. Real workflows will be executed by devices that individually support different versions of the specification. Complete **JDF** workflow descriptions MAY therefore contain sub **JDF** nodes that SHALL be specified with different versions in one document.

3.13.1 JDF Versioning Requirements

The following list of requirements take the specific needs of a mixed version **JDF** workflow into account:

- **JDF** documents with mixed versions SHALL be supported.
 - Environments with devices that support different **JDF** versions will exist.
 - It is not feasible to enforce simultaneous software upgrades for devices from multiple vendors in one production facility.
- MIS systems might not support all versions of all devices that are described in the **JDF**.
 - Customers might update a workflow system or device without updating the MIS system.
- Archived **JDF** documents SHALL remain valid when a new version of the **JDF** specification and schema is published.

3.13.2 JDF Version Definition

The version of a **JDF** node is defined as the highest version of all attributes or elements and linked resources. The version of a resource is defined as the highest version of all elements, attributes or resources that are referenced via reelements.

3.13.3 JDF Version Policies

The following specifies the policies for evolving **JDF** 1.x versions. When the term "**JDF**" is used in the remainder of this section, the reader also ought to interpret these policies to apply to **JMF** as well. Version policies include three areas of application: **JDF** specification rules, **JDF** schema definition rules and **JDF** application behavior. The policies are applicable to the transition from **JDF** 1.1/1.1A through to **JDF** 1.4, as well as future versions of **JDF**, but are not applicable to **JDF** 1.0.

3.13.3.1 JDF Specification Version Policies

The following list defines the policies that will be followed when extending the **JDF** specification.

- Changes to the **JDF** specification are always backwards compatible.
 - Extension elements or attributes are never required.
 - New attributes in existing elements SHALL be optional.
 - New elements in existing elements SHALL be optional.
 - New elements MAY contain required elements or attributes.
 - Elements and attributes are never removed.
 - Deprecated elements or attributes continue to be valid in all versions of **JDF** 1.x
- Data type changes SHALL be extensions of existing data types. In other words the data type of an extended attribute SHALL be a complete superset of the existing data type. For instance, only the extensions defined by the arrow directions are valid.

- enumeration → NMTOKEN
- NMTOKEN → string
- integer → IntegerList
- integer → double
- The **JDF/@Version** and **JMF/@Version** attributes are REQUIRED in the respective root of **JDF** or **JMF** instance documents.
- The semantics of attributes and elements SHALL NOT be altered.
 - New attributes or elements SHALL NOT be introduced that conditionally modify the semantics of existing attributes and elements.
 - Semantics MAY only be altered when the previous definition is clearly wrong and the result is unpredictable with the previous definition (e.g., bug fixes in the specification). These changes SHALL be clearly marked in the specification.
- The default values of attributes and elements SHALL NOT be altered.
 - The default behavior that is specified when an attribute or element is missing SHALL NOT be altered.

3.13.3.2 JDF Schema Version Policies

The following list defines the policies that will be followed when generating new schemas for new versions of the **JDF** specification.

- Changes to the **JDF** schema SHALL always be backwards compatible.
 - **JDF** 1.x documents SHALL validate against **JDF** 1.(x+n) schemas.
- Only one **JDF** schema namespace SHALL be defined for all versions of **JDF** 1.x.
 - The namespace is `http://www.CIP4.org/JDFSchema_1_1`.
- The `xs:version` attribute SHALL BE defined in the schema.
 - Applications that read a schema MAY verify that they are compatible with the version of the schema.
 - Applications MAY choose a schema based on the schema's version tag.
 - The schema version selection MAY be based on a best match to both application and **JDF** ticket or even **JDF** node.
- The **JDF/@Version** attribute is defined as an enumeration that contains all valid versions for the schema (e.g., "1.1", "1.2" and "1.3" for the **JDF** 1.3 version of the schema). The schema data type of a **JDF** or **JMF** version is "**JDFJMFVersion**".
 - This allow schema validators to detect incompatible versions when parsing a local legacy schema.
- The version annotations in the schema SHOULD be maintained wherever possible.
- Explicit copies of published legacy schema versions SHALL be available on the CIP4 website.
- The schema default values of deprecated attributes SHALL be removed from the schema. Deprecated attributes SHALL still be valid but SHALL NOT be explicitly defaulted in the schema.

3.13.3.3 JDF Application Version Policies

This section specifies the policies that implementations SHOULD follow in order to support multiple versions of **JDF**. The policies are specified for agents and controllers/devices separately.

3.13.3.3.1 JDF Agent Version Policies

JDF agents SHALL ensure that the **JDF** that they generate is consistently versioned.

- An agent SHALL update the **JDF/@Version** attribute when inserting new attributes or elements.
 - If an agent is not aware of versions, it SHALL assume that anything that it writes belongs to the agent's maximum version. In this case, the version of any node that is affected is the maximum of its prior version or the agent's version.
- It is strongly RECOMMENDED that an agent honor the **JDF/@MaxVersion** attribute.
 - An agent SHOULD NOT add attributes, elements or attribute values that were introduced in a version that is higher than **JDF/@MaxVersion**.
- An agent SHOULD insert the lowest possible **JDF/@Version** attribute that is applicable to the nodes version as described in ▶ Section 3.13.2 JDF Version Definition.
- The **JDF/@Version** of a spawned **JDF** node is identical to the **JDF/@Version** of that node in a complete **JDF**.

3.13.3.3.2 JDF Device/Controller Version Policies

A **JDF** device/controller (i.e., any implementation that reads **JDF**) SHOULD be backwards compatible:

- Implementations SHOULD handle deprecated elements and attributes gracefully.

JDF devices/controllers (i.e., any implementation that reads **JDF**) SHOULD attempt to be forwards compatible.

- Schema validation errors that find an unknown attribute, element or attribute value in a **JDF** with a version that is higher than the schema SHOULD NOT lead to an abort.

STRUCTURE

- A device or controller that reads a **JDF** with an element or attribute or attribute value with a version that is higher than the version that it was developed for SHOULD attempt to execute the **JDF** if `@SettingsPolicy = "BestEffort"`.
- A device or controller that reads a **JDF** with an element or attribute or attribute value with a version that is higher than the version that it was developed for SHALL NOT execute the **JDF** if `@SettingsPolicy = "MustHonor"`.
- Implementations SHOULD handle non-fatal version schema validation errors gracefully.
- Unknown attributes/elements in the **JDF** namespace SHOULD be treated the same as foreign namespace attributes/elements when handling nodes that are not executed by the device or controller.
- Unknown versions of the **JDF** namespace SHOULD be treated analog to foreign namespace elements when handling nodes that are not executed by the device or controller.

4 Life Cycle

Introduction

This chapter describes the life cycle of a **JDF** job, from creation through modification to processing. Information is provided about the spawning of individual steps of jobs and in what way they are merged into the job once the process step is completed.

4.1 Creation and Modification

The life cycle of a **JDF** job will likely follow one of two scenarios. In the first scenario, a job is created all at once by a single agent and then is consumed by a set of devices. More often, however, a job is created by one agent and is then transformed, or modified, over time by a series of other agents. This process might require specification of product intent, which is defined in ▶ Section 4.1.1 Product Intent Constructs.

Jobs can be modified in a variety of ways. In essence, any job is modified as it is executed, since information about the execution is logged. Another instance of modification of a **JDF** job, however, occurs during processing when more detailed information is learned or understood and then added along the way. This information might be added because an agent knows more about the processing needed to achieve some result specified in a **JMF** node than the original, creating agent knew. For example, one agent might create a product intent node that specifies the product intent of a series of pages. This product intent node might include information about the number of pages and the paper properties. Another node might then be inserted that includes a resource describing how the pages are to be RIPed. Later, another agent might provide more detail about the RIPing process by appending optional information to the RIP **Resource**.

Regardless of where in the life cycle they are written, nodes and their resources SHALL be valid and include all REQUIRED information in order to have a *@Status* of "Ready" (in case of nodes) or "Available" (in case of resources). This restriction allows for the definition of incomplete output resources. For example, a URL resource without a file name might be completed by a process. On the other hand, it is impossible to define a valid and executable node with insufficient input parameters.

Once all of the inputs and parameters for the process requested by a node are completely specified, a controller can route the **JDF** job containing this node to a device that can execute the process. When the process is completed, the agent/controller in charge of the device will modify the node to record the results of the process.

4.1.1 Product Intent Constructs

JDF jobs, in essence, are requests made by customers for the production of quantities of some product or products. In other words, a job begins with a particular goal in mind. In **JDF**, product goals are often specified by using a construct called "product intent" and represented by **Product Intent Nodes**. In contrast to process resources that define precise values, **Product Intent Nodes** allow ranges or sets of preferred values to be specified. Resources of this kind include **ColorIntent**, **FoldingIntent**, **MediaIntent** and **ShapeCuttingIntent**, all of which are described in ▶ Chapter 8 Resources.

The product intent of a job is like a blue print of a product. The blue print might be extremely vague, detailing only the general goal, or it might be very specific, stipulating the specific requirements inherent in meeting that goal. Product intent might be defined for an end product about which little is known or about which the processing details for the job are entirely unknown. Product intent constructs also allow agents to describe jobs that comprise multiple product components and that might share some parts.

The initiating agent of a job specifies either product intent or a full set of processes. The various kinds of process nodes are described in ▶ Section 3.3.1 Product Intent Nodes, ▶ Section 3.3.2 Process Group Nodes and ▶ Section 3.3.3 Combined Process Nodes. Any job that specifies product intent SHALL include nodes whose *@Type* = "Product". This representation is described in the following section.



product intent

"product intent" is another way of saying "Job Specifications". Rather than describing how a job will be made, product intent describes what a finished product (or some aspect of a product) will look like when it is completed. Product intents can initiate with the customer and in rather vague terms, and they might be later fleshed out or completed by a printer's customer service representative, estimating department or production planners.

4.1.1.1 Representation of product intent

The product description of a job is a hierarchy of product intent nodes, and the bottom-most level of the product hierarchy represents portions of the product that are each homogeneous in terms of their materials and formats. All nodes below these product intent nodes begin specifying the processes needed to produce the products.

Product intent nodes are REQUIRED to contain only one thing, and that is a resource that represents the physical result specified by the node. This resource is generally a **Component**. In addition, somewhere in the hierarchy of product intent nodes, it is a good idea to include an **Intent Resource** to describe the characteristics of the intended product. Although these are the only resources that SHOULD occur, product intent nodes can contain multiple resources. For example, some resource types, such as **LayoutIntent** and **MediaIntent**, are defined to provide more general mechanisms to specify product intent. The resulting product of a product intent node is specified as an output **Component** resource of the product intent node.

In some cases, more than one high level product intent node will use the output of a product intent node. These high level nodes represent the combination of homogeneous product parts. In this case, the **@Amount** attribute of the **ResourceLink** elements that connect the nodes will identify how the lower level product is shared.

4.1.1.2 Representation of Product Binding

Some **Intent Resources**, such as **BindingIntent** or **InsertingIntent**, define how to combine multiple products. To accomplish this, the respective component resources SHALL be labeled according to their usage. For example, the cover and insert of a product are identified by **ComponentLink/@processUsage** attribute of the respective input **ComponentLink** elements. For more information about product intent, see ▶ Section 3.3.1 Product Intent Nodes.

4.1.2 Specification of Delivery of End Products

A job can define one or more products and specify a set of deliveries of end products. To accomplish this, a node **JMF** [**@Type="Product"**] is created to define each product to be produced. The root product intent node SHOULD contain a **DeliveryIntent** resource that specifies a set of **DroplIntent** elements. Each **DroplIntent** element has a common delivery address and time, and a set of **DropltemIntent** elements that specifies the amount of individual **Component** elements to deliver to this address. Quote generation as defined in the previous chapter includes the specification of delivery addresses. For more information, see ▶ Section 6.2.4 Delivery.

4.1.3 Specification of process Specifics for product intent nodes

Product intent nodes are designed to represent a customer's view of the product. In some instances, a knowledgeable customer might want to specify production details that are only available in **JDF** process resources for a given product. Examples include scanning or screening parameters. This customer will still have no knowledge or control of the process workflow and therefore is expected to specify only the **Resource** elements.

Individual **JDF** process resources MAY be referenced from the **ProductionIntent** resource. **Resource/@Status** will most likely be **"Incomplete"** because generally the customer does not know all parameters of the **Resource**.

Example 4.1: Product Intent Node

The following example shows how specific information about screening is specified in an intent node by referencing [ScreeningParams](#) with [ProductionIntent/ScreeningParamsRef](#).

```
<JDF ID="Job1" JobID="J1" JobPartID="P1" Status="Waiting" Type="Product"
Version="1.6" xmlns="http://www.CIP4.org/JDFSchema_1_1">
  <ResourcePool>
    <Component Amount="10000" Class="Quantity" ComponentType="Sheet"
      DescriptiveName="Complete 16-page Brochure" ID="Link0003" Status="Unavailable"/>
    <LayoutIntent Class="Intent" ID="Link0004" Status="Available">
      <Dimensions DataType="XYPairSpan" Preferred="612 792" Range="576 720 ~ 648 864"/>
      <Pages DataType="IntegerSpan" Preferred="16"/>
    </LayoutIntent>
    <MediaIntent Class="Intent" ID="Link0005" PartIDKeys="Option" Status="Available">
      <FrontCoatings DataType="EnumerationSpan" Preferred="None"/>
      <MediaIntent Option="1">
        <FrontCoatings DataType="EnumerationSpan" Preferred="Glossy"/>
      </MediaIntent>
      <BackCoatings DataType="EnumerationSpan" Preferred="None"/>
    </MediaIntent>
    <ProductionIntent Class="Intent" ID="ID_PI" Status="Available">
      <ScreeningParamsRef rRef="ScreenID"/>
    </ProductionIntent>
    <ScreeningParams Class="Parameter" ID="ScreenID" Status="Incomplete">
      <ScreenSelector ScreeningFamily="My favorite screen" SpotFunction="Ellipse"/>
    </ScreeningParams>
  </ResourcePool>
  <ResourceLinkPool>
    <ComponentLink Usage="Output" rRef="Link0003"/>
    <LayoutIntentLink Usage="Input" rRef="Link0004"/>
    <MediaIntentLink Usage="Input" rRef="Link0005"/>
    <ProductionIntentLink Usage="Input" rRef="ID_PI"/>
  </ResourceLinkPool>
</JDF>
```

4.2 Process Routing

A controller in a **JDF** workflow system has two tasks. The first is to determine which of the nodes in a **JDF** document are executable, and the second is to route these nodes to a device that is capable of executing them. Both of these procedures are explained in the sections that follow.

In a distributed environment with multiple controllers and devices, finding the right device or controller to execute a specific node might be a non-trivial task. Systems with a centralized, smart master controller might want to route jobs dynamically by sending them to the appropriate locations. Simple systems, on the other hand, might have a static, well defined routing path. Such a system might, for example, pass the job from hot folder to hot folder. Both of these extremes are valid examples of **JDF** systems that have no need for additional routing metadata.

In order to accommodate systems between these extremes, the [NodeInfo](#) resource of a node contains OPTIONAL [@Route](#) and [@TargetRoute](#) attributes that let an agent define a static process route on a node-by-node basis. [JMF/QueueSubmissionParams/@ReturnURL](#) takes precedence over [NodeInfo/@TargetRoute](#) of the **JDF** node that is processed. If no [@Route](#) or [@TargetRoute](#) attribute is specified and if a controller has multiple options for where to route a job, it is up to the implementation to decide which route to use.

The controller or device reading the **JDF** job is responsible for processing the nodes. A device examines the job and attempts to execute those nodes that it knows how to execute, whereas a controller routes the job to the next controller or device that has the appropriate capabilities.

4.2.1 Determining Executable nodes

In order to determine which node to execute, the controller/device SHALL use the following procedures.

- 1 It searches the **JDF** document for node types that it can execute or Gray Boxes that it can expand by comparing the [@Type](#) and [@Types](#) attributes and possibly the [@Category](#) attribute of the node to its own capabilities and by determining the [@Activation](#) of the nodes. It SHOULD also verify that the [@Status](#) of the node or the respective [NodeInfo/@nodeStatus](#) is either "Waiting" or "Ready". If a [Device](#) resource is specified as input to the node, the resource SHALL match the controller/device. Devices MAY opt to limit the scope of the node search. The limitations SHOULD be specified in the device capability description by appropriately setting [DeviceCap/@ExecutionPolicy](#).

LIFE CYCLE

- 2 The controller/device can then determine if any resources have a `@Status` of "Incomplete" or a `@SpawnStatus` of "SpawnedRW". It SHOULD also determine if all of the input resources of the respective nodes have a `@Status` of "Available" and that all processes that are attached through pipes are ready to execute. A controller MAY skip these checks and expect the lower level controller or device that it controls to perform this step and return with an error if it fails.
- 3 If scheduling information is provided in the `NodeInfo` resource, the specified start and/or end time SHALL be taken into account by the executing device. If no process times are specified, it is up to the device in charge of queue handling to execute the process node.
- 4 If no executable nodes are found, the device SHALL return the node to the controller. A `Notification` audit element with `Notification/@Class = "Error"` SHOULD be appended to the `AuditPool` of the root `JDF` node. `Notification/Error/@ReturnCode = "102"` specifies that no executable node was found.

The node will go through various states during its life time as is described in ▶ Figure 4-1: Life cycle of a JDF node

Figure 4-1: Life cycle of a JDF node

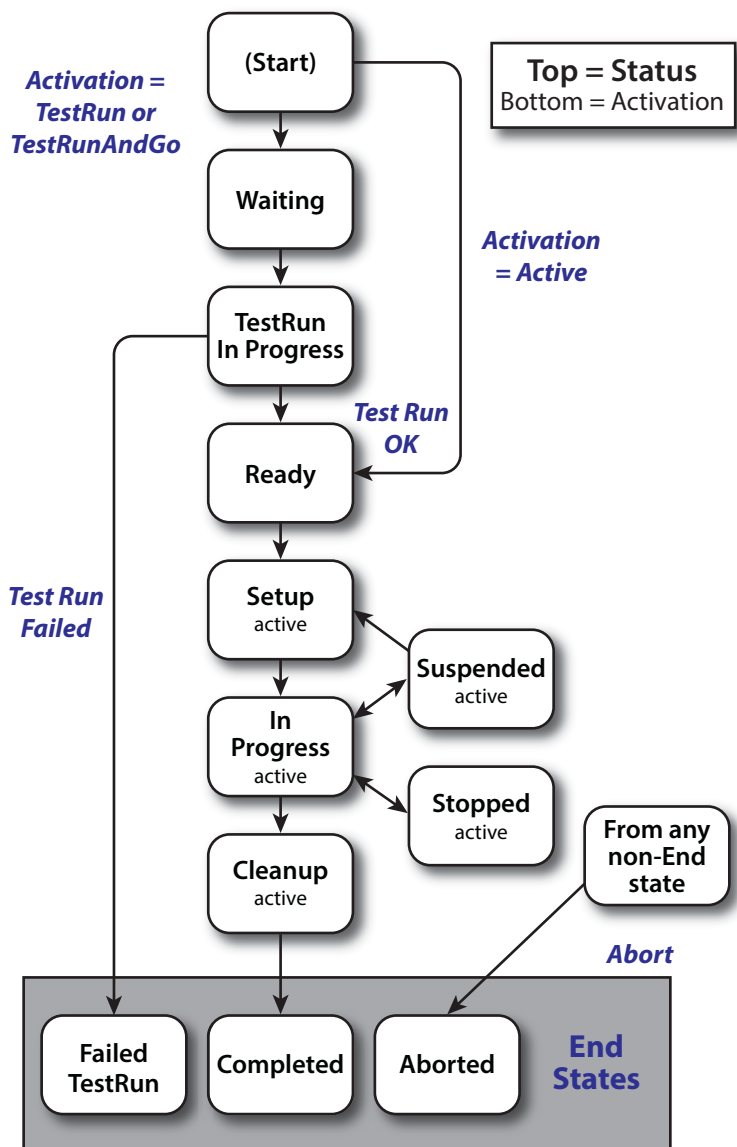

4.2.2 Distributing processing to Work Centers or devices

JDF syntax supports two means of distributing processes to work centers or devices. Its first option is to use a “smart” controller that has the ability to parse a **JDF** job and identify individual processes or process groups that might be distributed to a particular work center or device. This smart controller MAY use spawning and merging facilities to subdivide the job ticket and pass specific instructions to a work center or device.

The second option, which is applicable when the controller being used isn’t smart, is to employ a simple controller implementation that routes the entire job to each work center or device, thus leaving it up to the recipient to determine the processing it can accomplish. For this option to work, each **JDF** capable device SHALL be able to identify process nodes

it is capable of executing. Furthermore, each device SHALL have sufficient **JDF** handling capabilities to identify processes that are ready to run.

4.2.3 Device / Controller Selection

The method used to determine which is the appropriate device or lower level controller to use to execute a given node depends greatly on the implemented workflow being used. Although **JDF** provides a method for storing routing information in the `@Route` attribute of the `NodeInfo` resource of a node, it does not prescribe any specific routing methods. However, some of the tools available to figure out alternative workflows are described below.

Knowledge of the capabilities of lower level controllers/devices either MAY be hard-wired into the system or gained using the `KnownDevices` message. Since **JDF** does not yet provide mechanisms to determine if a given device is capable of processing a node without actually performing a test run, a controller SHALL either have a prior knowledge of the detailed capabilities of its controlled devices or perform a test run to determine if a device is capable of executing a node. Furthermore, in addition to the explicit routing information in the `@Route` attribute of the `NodeInfo` resource of a node, **JDF** MAY contain implicit routing information in the form of `Device ImplementationResources`.

JMF defines the `KnownDevices` query message to find controllers and devices. The information provided by this query can be used by a controller to infer the appropriate routing for a node. In a system that does not support messaging, this information will be provided outside of **JDF**.

4.3 Execution Model

JDF provides a range of options that help controllers tailor a processing system to the needs of the workflow and of the job itself. The following sections explain the ways in which controllers execute processes using these various options.

The processing model of **JDF** is based on a producer/consumer model, which means that the sequencing of events is controlled by the availability of input resources. As has been described, nodes act both as producers and consumers of resources. When all necessary inputs are available for a given node, and not before, the process can execute. The sequence of processing, therefore, is implied by the chain of resources in which the output resources of one node become the input resources of a subsequent node.

JDF supports four kinds of process sequences: serial processing, overlapping processing, parallel processing and iterative processing. All four are described in the following sections.

4.3.1 Serial processing

The simplest kind of process routing, known as serial processing, executes nodes sequentially and with no overlap. In other words, no nodes are executed simultaneously. Once the process has acted upon the resource in some way, the resource availability is described by the `@Status` attribute of the resource, as described above. When the process state is "Ready" or "Waiting", the process can begin executing.

In a workflow using serial processing, the controller is responsible for comparing the actual amount available with the specified amount in the corresponding `ResourceLink` element to determine whether or not the input resource can be considered available. If no amount is specified in the `ResourceLink`, the process is assumed to consume the entire `PhysicalResource`.

Figure 4-2: Example of a simple process chain linked by resources

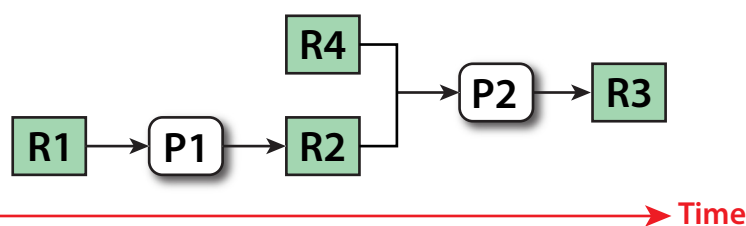

► Figure 4-2: Example of a simple process chain linked by resources depicts a simple process chain that produces and consumes `Quantity Resource`s and uses an `ImplementationResource`. The resources R1, R2 and R3 represent `Quantity Resource`s. Process P1 consumes resource R1 and produces resource R2. R2 is then completely consumed by P2, which also requires the `ImplementationResource` R4 for processing. Process P2 uses these two resources and produces resource R3. All of this is accomplished along a linear time axis.

► Table 4.1 Examples of resource and process states in the case of simple process routing shows the value of the `@Status` attribute of each of the resources and processes used in ► Figure 4-2: Example of a simple process chain linked by resources. The time axis runs from left to right both in ► Figure 4-2: Example of a simple process chain linked by resources and in ► Table 4.1 Examples of resource and process states in the case of simple process routing. Note that no process can execute until all resources leading up to that process are "Available". In other words, the job executes serially

and sequentially. For more information about the values of the `@Status` attribute of resources, see ▶ Table 3.8 Abstract Resource Element . For more information about the values of the `@Status` attribute of processes, see ▶ Table 3.4 JDF.

Table 4.1: Examples of resource and process states in the case of simple process routing

OBJECT STATUS	BEFORE RUNNING P1	DURING RUNNING P1	AFTER RUNNING P1, BEFORE P2	DURING P2	AFTER P2
Resource R1	Available	InUse	Unavailable	Unavailable	Unavailable
Resource R2	Unavailable	Unavailable	Available	InUse	Unavailable
Resource R3	Unavailable	Unavailable	Unavailable	Unavailable	Available
Resource R4	Available	Available	Available	InUse	Available
Process P1	Waiting or Ready	InProgress	Completed	Completed	Completed
Process P2	Waiting or Ready	Waiting or Ready	Waiting or Ready	InProgress	Completed

If a process aborts before completion, its output resources are "Unavailable" unless the output has been partially produced, in which case the device MAY update the amount and set the output to "Available".

When the `@Amount` attribute is used in connection with the quantifiable resources R1, R2 or R3 and their links, then the controller SHALL decide whether or not a resource is available by comparing the individual values. If the amounts are used to define the availability, then the resource `@Status` MAY be set to "Available" for all **Quantity Resources**. Note that when the value of the `@Status` attribute of the resource is "Unavailable", the resource is not available even if a sufficient `@Amount` is specified.

If amounts are specified in the resource element, they represent the actual available amount. If they are not specified, the actual amount is unknown, and it is assumed that the process will consume the entire resource. Amounts of **ResourceLink** elements SHALL be specified for output resources that represent the intended production amount. The specification of the `@Amount` attribute for input resources is OPTIONAL. For details, see ▶ Section 3.10.4 Resource Amount . If the controller cannot determine the amounts, this constitutes a **JDF** content error, which is logged by error handling. This process is described in ▶ Section 4.6 Error Handling.

If a process in a serial processing run does not finish successfully, the final process status is designated as "Aborted". In an aborted job, only a part of the intended production might be available. If this occurs, the actual produced amount is logged into the **AuditPool** by a **ResourceAudit** element.

4.3.2 Partial processing of nodes with Partitioned resources

New in JDF 1.2

JDF nodes themselves SHALL NOT be partitioned, although the input and output resources MAY be partitioned. If the input and output **ResourceLink** elements reference one or more individual partitions, the **JDF** node executes using only the referenced resources.

If multiple input resources are input to a process, the resource with the highest granularity defines the partitioning. For instance, a **ConventionalPrinting** process might consume a non-Partitioned **ConventionalPrintingParams** and a set of **Ink** and **ExposedMedia (Plate)** resources that are partitioned by "Separation". The partition granularity will be defined by the **Ink** and **ExposedMedia (Plate)** resources to be "Separation". The "Separation" partition set is defined by the superset of all defined partition key values. If the "Separation" key values of **Ink** were "Black" and "Varnish", and the `@Separation` key values of **ExposedMedia (Plate)** were "Black", the resulting set is "Black" and "Varnish".

The partition keys of both input and output restrict the process. If the partition keys are not identical, both SHALL be applied to restrict the node. If the partition keys are non-overlapping (e.g., in an **Imposition** node where a **RunList** based input partition is mapped to a sheet based output partition), the application SHALL explicitly calculate the result. The following examples in ▶ Table 4.2 Examples of Partitioning across multiple resources illustrate the restriction algorithms:

Table 4.2: Examples of Partitioning across multiple resources (Sheet 1 of 2)

INPUT PARTITION 1	INPUT PARTITION 2	OUTPUT PARTITION	NODE PARTITION	DESCRIPTION
<code>@SheetName = "S1"</code>	—	—	<code>@SheetName = "S1"</code>	If only the input is partitioned, the node partition is defined by the input.

Table 4.2: Examples of Partitioning across multiple resources (Sheet 2 of 2)

INPUT PARTITION 1	INPUT PARTITION 2	OUTPUT PARTITION	NODE PARTITION	DESCRIPTION
@SheetName = "S1" @Separation = "Cyan"	—	—	@SheetName = "S1" @Separation = "Cyan"	If only the input is partitioned, the node partition is defined by the input.
@SheetName = "S1" @Separation = "Cyan"	@Separation = "Cyan" + @Separation = "Black" (@PartUsage = "Implicit")	—	@SheetName = "S1" @Separation = "Cyan" + @SheetName = "S1" @Separation = "Black"	The first input is partitioned by @SheetName and @Separation which defines the partition key granularity. The second input is partitioned by @Separation only but has an implied @SheetName and has a larger but overlapping set of separation values. The separation value set is therefore defined by the second key.
@SheetName = "S1"	—	@SheetName = "S1" @Separation = "Cyan"	@SheetName = "S1" @Separation = "Cyan"	The input and output base partitions are identical. The output further restricts the partition.
@SheetName = "S1"	—	@SheetName = "S2" @Separation = "Cyan"	Error	Input and output are not overlapping. This specifies the null set.
@SheetName = "S1" @Separation = "Magenta"	@Separation = "Cyan" + @Separation = "Black"	—	Error	This is an error and defines the null set. The first input is partitioned by @SheetName and @Separation which defines the partition key granularity. The second input is partitioned by @Separation only and has a larger but non-overlapping set of separation values. The separation value set is therefore the null set.
@SheetName = "S1" @Separation = "Cyan"	@Separation = "Cyan" + @Separation = "Black" (@PartUsage = "Explicit")	—	Error	The first input is partitioned by @SheetName and @Separation which defines the partition key granularity. The second input is partitioned by @Separation only but has no implied @SheetName and therefore has a non-overlapping set of partition keys. The separation value set is therefore defined by the second key.
@RunIndex = "0 ~ 7"	—	@SheetName = "s2"	Special	This specifies sheet s2, with all PlacedObject elements with an @Ord in the range of 0 to 7. This special case is important when RunList entries occur multiply on different imposition sheets.

4.3.3 Overlapping processing Using Pipes

Whereas pipes themselves are identified in the resource that represents the pipe by specifying **Resource/@PipeID**, pipe dynamics are declared in the **ResourceLink** elements that reference the pipe. This allows multiple nodes and devices to access one pipe, each of them with its own pipe buffering parameters.

In some situations, resource linking is a continuous, dynamic process rather than a predefined static process. In other words, one process might require the output resources of another process before that process has completely finished producing them. The ability to accomplish this kind of resource transfer is known as overlapping processing, and it is accomplished with the use of a mechanism known as pipes. Pipes are considered to be **active** if any process linking to the pipe simultaneously consumes or produces that pipe resource.

Any resource MAY be transformed into a pipe resource by specifying the **@PipeID** attribute in the resource. Pipes resemble reservoir containers that hang between processes. Processes connected to the pipe via output links fill the container with necessary resources, while processes connected via input links deplete it (see ▶ Figure 4-3: Example of a pipe resource linking two processes via pull and ▶ Figure 4-4: Example of a pipe resource linking two processes via push). The level is controlled by the **ResourceLink** attributes **@PipeResume** and **@PipePause** (see ▶ Table 3.14 ResourceLink Element and ▶ Table 3.16 PartAmount Element). The unit of the buffers is defined by the **@Unit** attribute of the resource.

The two following diagrams show the ways in which pipes mediate between the process producing the resource and the process consuming the resource. The following OPTIONAL attribute values are defined for pipes:

ResourceLink/@PipePartIDKeys – specifies the granularity of a pipe request for partitioned resources.

ResourceLink/@PipePause – specifies at which resource level to pause a pipe.

Resource/@PipeProtocol – specified the protocol to use to pause, resume and initiate a pipe.

ResourceLink/@PipeResume – specifies at which resource level to resume a pipe.

The specified value of each of these attributes in any given **ResourceLink** dictates the levels at which a pipe SHOULD resume or pause execution. ▶ Figure 4-5: Example of status transitions in case of overlapping processing gives an example of a view on the dynamics of a pipe resource. The available level of the pipe resource, represented as R2, and the availability status of two entity resources, represented as R1 and R3, are changing along a time line. Below the progressions of these resources is the status of two processes — P1 and P2. P1 represents the process producing the pipe resource and P2 represents the process consuming that resource. The resource status of an active pipe, represented here as R2, is defined to be **@Status= "InUse"** (see also ▶ Table 3.8 Abstract Resource Element).

Figure 4-3: Example of a pipe resource linking two processes via pull

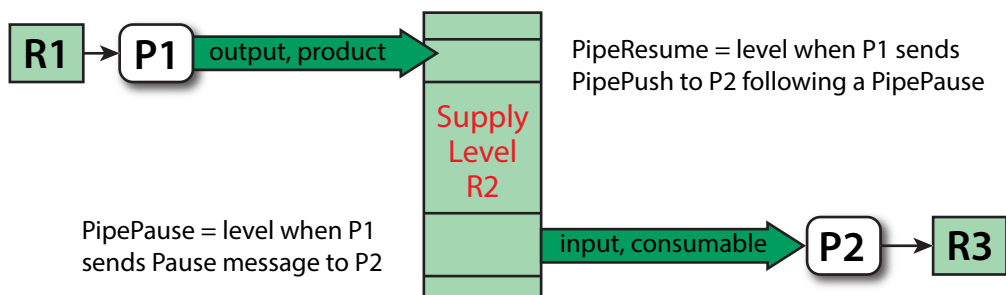

Pipe Resources

A pipe resource is simply an input to a process that can be exhausted and can be replenished. Examples might include rolls of paper feeding into a press, ink well levels, fountain solution, or even proofing stock loaded into a proofer.

Another type of pipe resource in everyday use is a “hot-folder” or “watched file.” Hot folders are used to automate functions such as preflighting. When a file is saved to a hot-folder, the system knows to automatically apply a defined process to the new file. When the folder is empty the processing stops.

Figure 4-4: Example of a pipe resource linking two processes via push

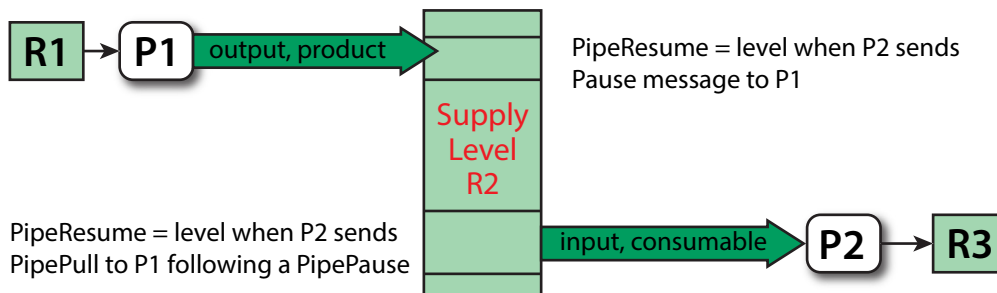

► Figure 4-3: Example of a pipe resource linking two processes via pull and ► Figure 4-4: Example of a pipe resource linking two processes via push are views of the structure and ► Figure 4-5: Example of status transitions in case of overlapping processing a view of the dynamics of the pipe example considered here. R1 represents an input resource for P1, which feeds into the intermediate pipe resource R2. Once the container R2 is filled to the predetermined level, it is used as the input resource for P2, which in turn produces output resource R3.

Figure 4-5: Example of status transitions in case of overlapping processing

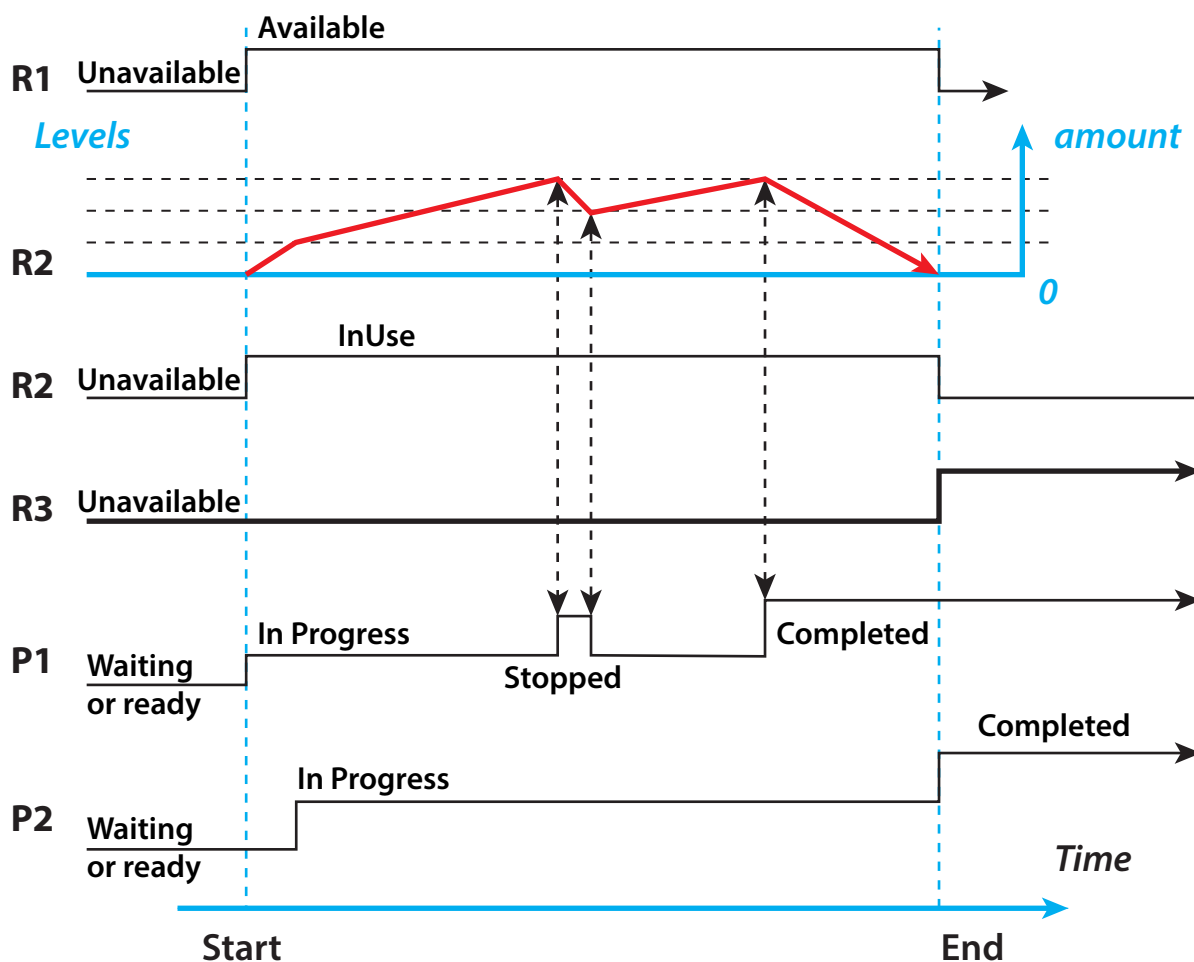

Resource linking through pipes is controlled through the specification of the `@PipePause` and `@PipeResume` attributes. The intended amount of a resource MAY be specified in advance in the output `ResourceLink`. Whenever the level representing the available quantity of the pipe resource exceeds the `@PipePause` level of the `ResourceLink`, the process P1 is halted (`@Status = "Stopped"`) so that the process does not overproduce. Once the level falls below the `@PipeResume` value, the process P1 resumes execution. P1 is completed when it has produced the intended amount. Once P1 has performed its task, the resources still in the pipe are consumed by the subsequent process without level control. In other words, after a process filling a pipe buffer has completed, pipe buffering becomes disabled.

In the case of output **ResourceLink** elements, the **@PipeResume** value SHALL be smaller than the **@PipePause** value, whereas in the case of input **ResourceLink** elements, the **@PipeResume** value SHALL be greater than the **@PipePause** value. If **@PipePause** is specified for a **ResourceLink** and **@PipeResume** is not specified, the related process might run into a deadlock state. In other words, the process stops and cannot resume execution automatically. Once a process is stopped under these circumstances it can only be resumed manually or by sending a pipe control message for resumption that allows interconnected execution control (halting and resumption of processes by pipe control messages is described in ▶ Section 5.10 Messages for Pipe Control). If the attributes **@PipeResume** or **@PipePause** of **ResourceLink** elements to pipe resources are not specified, the controller is responsible when the linked processes start and stop independent of the level.

4.3.3.1 Dynamic Pipes

In addition to abstractly declaring pipe properties, **JMF** provides pipe messages that allow dynamic control of pipes. Dynamic pipes can be used to model situations where the amount of resources is not known beforehand but becomes known during processing. An example of this behavior is a long press run where new plates are needed during a press run because of quality deterioration. The exact point in time where quality becomes unacceptable is not predetermined and might even vary from separation to separation. Dynamic pipes provide the flexibility to adjust to changing situations of this nature.

Another usage of dynamic pipes is linking the output of a variable data print job to various components. Examples include a pipe describing the **RunList** that links the RIP to a print engine or a pipe describing the **Component** that links the printer to finishing equipment or individual finishing devices. In this case, the **RunList** and **Component** are templates that are logically expanded in increments by the pipe messages.

Dynamic pipes provide a **ResourceLink/@PipeURL** attribute that allows dynamic requests for a status change of the pipe while a process is executing. Dynamic requests use **JMF** pipe control messages (see ▶ Section 5.10 Messages for Pipe Control) sent to another controller whose URL address is specified by the **@PipeURL** attribute of the respective **ResourceLink**. Depending on the values of the **Resource/@PipeProtocol** attribute, the following actions are possible.

- **"JMFPull"**: The consumer initiates the pipe by sending a **PipePull** message to its **ResourceLink/@PipeURL**. The consumer MAY request new resources by sending **PipePull** messages. If the producer reaches the pipe-pause (low water) mark, or is incapable of fulfilling **PipePull** messages for other reasons such as a malfunction, it SHOULD send a **PipePause** message to the consumer. Once it has reached the pipe-resume (high water) mark, or the malfunction has been removed, it SHOULD send a **PipePush** message to the consumer to inform the consumer that it can commence sending **PipePull** messages. The consumer SHOULD send a **PipeClose** message to the producer if the consumer does not require any further resources.
- **"JMFPush"**: The producer initiates the pipe by sending a **PipePush** message to its **ResourceLink/@PipeURL**. The producer MAY dispatch new resources by sending **PipePush** messages. If the consumer reaches the pipe-pause (high water) mark, or is incapable of fulfilling **PipePush** requests for other reasons such as a malfunction, it SHOULD send a **PipePause** message to the producer. Once it has reached the pipe-resume mark (low water), or the malfunction has been removed, it SHOULD send a **PipePull** to the producer to inform the producer that it can commence sending **PipePush** messages. The producer SHOULD send a **PipeClose** message to the consumer if the producer cannot provide any further resources.

When dynamic pipes are used, **@PipeResume** and **@PipePause** define the buffering parameters that lead to a pipe control message to the remote device. The pipe control messages described later in ▶ Section 5.10 Messages for Pipe Control are designed to establish communication between processes at both ends of dynamic pipe, even if the corresponding processes are spawned separately.

The following table summarizes the actions to be taken when the buffer in a dynamic pipe reaches a certain level "L".

Table 4.3: Actions generated when a dynamic-pipe buffer passes various levels (Sheet 1 of 2)

PIPEPROTOCOL (SENDER)	SITUATION	MESSAGE	DESCRIPTION
JMFPull (consumer)	Ready to process	PipePull	The consumer has processing or buffering available and therefore the producer SHOULD produce resources.
JMFPull (creator)	$L < @PipePause$	PipePause	The creator has no resources available and therefore the consumer SHALL refrain from sending PipePull messages.
JMFPull (creator)	$L > @PipeResume$	PipePush	Sufficient resources have been produced by the creator and are ready for delivery to the consumer.

Table 4.3: Actions generated when a dynamic-pipe buffer passes various levels (Sheet 2 of 2)

PIPEPROTOCOL (SENDER)	SITUATION	MESSAGE	DESCRIPTION
JMFPush (producer)	Resources available	<i>PipePush</i>	Sufficient resources have been produced by the creator and are ready for Delivery to the consumer. therefore the consumer SHOULD consume resources.
JMFPush (consumer)	$L > @PipePause$	<i>PipePause</i>	The consumer has no processing or buffering space available and therefore the creator SHALL refrain from sending <i>PipePush</i> messages.
JMFPush (consumer)	$L < @PipeResume$	<i>PipePull</i>	The consumer has processing or buffering available and therefore the producer SHOULD commence sending <i>PipePush</i> messages.

Dynamic pipes are initially dormant and SHALL be activated by an explicit request. If *Resource/@PipeProtocol* = "JMF", dynamic pipe requests MAY be initiated by both ends of the pipe. As soon as the pipe has been initiated, actions that are required by the implied *@PipeProtocol* ("JMFPush" or "JMFPull") SHALL be applied. For example, a print process might notify an off-line finishing process when a certain amount is ready by sending a *PipePush* message, or the printing process might request a new plate by sending a *PipePull* message.

4.3.3.2 Pipes of Partitionable resources

Pipes of partitionable resources MAY also define the granularity of the resources that are considered to be one part by specifying the *@PipePartIDKeys* attribute in the appropriate *ResourceLink* element. For instance, a partitioned *ImageSetting* process could be defined for multiple sheet separations, but a complete set containing all separations of both sides of a single sheet would be sent to the press room as a single pipe request. In this case, the value of *ExposedMedia/@PartIDKeys* would be "SheetName Side Separation" and the value of the *ResourceLink/@PipePartIDKeys* for the pipe would be "SheetName". The resources specified in *PipeParams* SHOULD be reduced to only define the currently active parts. In the example above, only the selected *@SheetName* partition with all its *@Side* and *@Separation* partition leaves would be included in the message.

4.3.3.3 Example JMFPush Sequence

This section illustrates the concept of dynamic pipes using the example of variable data near line finishing being controlled by a variable data digital press.

The exchange resource is a *Component* that is the output of the *DigitalPrinting* combined node and the input of a combined *Folding* and *Stitching* booklet maker.

Table 4.4: Event Sequence in Digital Finishing (Sheet 1 of 2)

DIRECTION	TYPE	PIPEPARAMS DESCRIPTION
P->C	<i>PipePush</i> Sheet 0/1; Cover; Set 0	Initialize pipe
P->C	<i>PipePush</i> Sheet 0/5; Set 0	Next sheet
P->C	<i>PipePush</i>	Lots of next sheets
P->C	<i>PipePush</i> Sheet 4/7; Body; Set 35	Next sheet
P<-C	<i>PipePause</i> Sheet 4/7; Set 35	Paper jam in finisher - destroys Set 34 and 35
P<-C	<i>PipePull</i> Sheet 0; Set 34	Restart at page 0 of doc 34

Table 4.4: Event Sequence in Digital Finishing (Sheet 2 of 2)

DIRECTION	TYPE	PIPEPARAMS DESCRIPTION
P->C	PipePush Sheet 0/3; Set 34	Restart pipe
P->C	PipePush	Lots of next sheets
P->C	PipePause Sheet 4/7; Cover; Set 122	Paper jam in printer - destroys set 122
P<-C	PipePull Sheet 0; Set 122	Restart at page 0 of Doc 34(optional)
P->C	PipePush Sheet 0; Set 122	Restart at page 0 of Doc 122
P->C	PipePush	Lots of next sheets
P->C	PipePush Sheet 2/3; Body; Set 221	Last sheet - note zero based counting for index
P->C	PipeClose	Done

4.3.3.4 Comparison of Non-Dynamic and Dynamic Pipes

The **ResourceLink** between non-dynamic pipes provides the buffering parameters for the process to which the **ResourceLink** belongs. Therefore, many processes can link to the same pipe resource. Furthermore, each process has its own buffering parameters, whether it is a consumer or a producer. In order to control non-dynamic pipes, one master controller SHALL control all processes linked to the pipe resource.

In contrast, dynamic pipes provide a URL address to control a process at the other end of the pipe, to be controlled by the buffering parameters of the **ResourceLink** control the process at that end. In the case of dynamic pipes, no master controller is needed to control the pipe. Control is accomplished by sending pipe messages. If pipe resources are linked to multiple consumers or producers, such as two finishing lines that consume the output of one press one palette at a time, it is up to implementation to ensure consistency of the processes.

4.3.3.5 Metadata in Pipe Messages

PipeParams/Resource can contain metadata that is required by the recipient of the message. This metadata SHALL be specified as partition keys in **ResourceLink/Part** and additional details MAY be specified as the actual contents of the **Resource**. Partition key metadata provides a mechanism to retain context in large variable data jobs without requiring fully fleshed out partitioned **Resources** in the **JDF**.

A typical example of partition key metadata is **Part/@DocIndex**, **Part/@RunIndex** and **Part/@Side** to uniquely identify the context of a surface image that is sent from a RIP to a digital press.

4.3.4 Parallel processing

While serial processing assumes that all resources will be produced and consumed in a linear fashion, and while overlapping processing uses multiple processes that work together to use and create resources, there are times when it makes sense to run more than one process simultaneously, creating a multi-pronged workflow. This kind of process routing is known as parallel processing. Subsections of jobs are spawned off so that nodes can be executed individually and simultaneously by the appropriate devices. Once the processes are complete, the spawned nodes are merged back into the original job. The output resources of the merged nodes become inputs for later processes. For example, an insert could be produced independently of a cover, and both will be bound together later.

In parallel processing, processes can be run in a coordinated parallel fashion by using independent resources. An independent resource is a resource that is not shared between multiple processes. **ImplementationResources**, for example, cannot be shared and are therefore always independent, and **Consumable Resources** and **Quantity Resources** can each be split to function as independent resources. Individual partitions of partitionable resources are independent and can be processed in parallel. Read-only resources, such as parameters, can be shared without any restrictions, and can, therefore, be used in read-only mode for parallel processing. Process chains created by the use of independent resources are known as independent process chains.

Parallel processing can proceed in one of two ways. Either a controller can organize the **JDF** nodes in a way that allows it to initiate parallel processing, or it can use the spawning-and-merging mechanism to field out chunks of the job to

execute simultaneously. If a controller chooses the latter method, parent nodes that contain independent process chains can be spawned off and processed independently. For example, in order to improve production capacity, an agent could split **Consumable Resources** and create independent process chains in which each chain consumes its own resource part. Afterwards, the agent could submit one of the created job parts to a subcontractor and process the other part with its own facilities.

Parallel processing is used only to process multiple aspects of a job simultaneously; it is not used to process multiple copies of a **JDF** job. In other words, a job SHALL NOT be copied and sent to different controllers for parallel processing. For more information about spawning of jobs, see ▶ Section 4.4 Spawning and Merging.

4.3.5 Iterative processing

Some processes, especially in the prepress area of production, cannot be described as a serial or parallel set of process steps. Instead, a set of interdependent processes is iterated in a non-deterministic order. These processes are known as iterative processes. For example, an advertisement is laid out that requires a photographic image. During the layout phase, changes are to be made to the color settings of the image, which is then reinserted to the layout. Changes such as these can be described in a high level fashion by defining a resource **@Status** attribute of "Draft". As long as an input resource to a process has a **@Status** of "Draft", the **@Status** of the output resource SHALL NOT be "Available".

The **ResourceLink/@MinStatus** of a **ResourceLink** that links to a draft input resource SHALL be set to less than or equal "Draft" to state that a draft input resource is acceptable for a process. Thus a prepress layout process can be abstractly defined to work on draft resources until an acceptable output has been achieved, but the output PDL file will not be used for printing until **@Status** is "Available" and no longer designated as a "Draft"

Iterative processes can be set up in a formal fashion using dynamic pipes to convey parameter change requests or in an informal way that assumes that the operators of the various processes have an informal communication channel. Both are described in greater detail below.

4.3.5.1 Informal Iterative processing

Informal iterative processing does not require a complete redefinition of the resources needed at every iteration. This kind of processing is generally used in a creative workflow where a job is defined and gets refined in a series of steps until it is completed. The information about the changes is transferred through channels that bypass **JDF**. Nonetheless, the description of these processes in **JDF** is useful for accounting purposes, as the status of each process might be monitored individually.

The **ResourceLink** elements for informal processing contain an additional **@MinStatus** attribute which SHALL be set to "Draft", but in all other ways they are identical to the **ResourceLink** elements used in simple sequential processing. Furthermore, the nodes run through the same set of phases as they would in sequential processing. Nodes are designated only as "Stopped" and not as "Completed" after being processed for an iterative cycle. They are marked as completed after their output resources lose their **@Status** of "Draft".

4.3.5.2 Formal Iterative processing

In formal iterative processing, all **ResourceLink** elements between interacting processes are dynamic pipes. Every request for a new resource is initiated by a **PipePush** or **PipePull** message that contains at least one **Resource** element with the updated parameters. This resource is used by the process, and the resulting new output resource can be consumed by the requesting process. The **@Status** of "Draft" can be removed from a resource by sending the creator a **PipeClose** message that has the OPTIONAL **@UpdatedStatus** attribute set to "Available". A node can only reach a **@Status** of "Completed" if it has no remaining draft resources. Another method to remove the draft status is to define a node for an **Approval** process that accepts draft resources as inputs and has non-draft resources representing the same entities as outputs.

4.3.6 Approval, Quality Control and Verification

In many cases, it is desirable to ensure that an executed process or set of processes have been executed completely and/or correctly. In the graphic arts industry this is verified by generating approvals and signing them. **JDF** allows modeling of the approval process and modeling of the verification processes by allowing an OPTIONAL **ApprovalSuccess** Input resource in any process.

The **Approval**, **QualityControl** and **Verification** processes accept any one resource as an input, i.e. the resource to be approved, checked for quality or verified. The process should have an output resource of the same type which is used for the process results and, if approved, an **ApprovalSuccess** resource. An **ApprovalSuccess** resource SHALL NOT be set as "Available" unless it has been signed by an authorized person. For hard copy proofing, a combined process (e.g., ending with the **ImageSetting**, **ConventionalPrinting** or **DigitalPrinting** process) generates the hard proof which is input to a separate **Approval** process. For soft proofing, a combined process (ending with **Approval** process) generates the soft proof which is approved by that **Approval** process.

JDF provides a **QualityControl** process to verify that the output of a process fulfills certain quality criteria. This differs from the **Verification** process, which verifies the completeness of a given set of resources.

4.4 Spawning and Merging

JDF spawning is the process of extracting a **JDF** subnode from a job and creating a new, complete **JDF** document that contains all of the information needed to process the subnode in the original job. Merging is the process of recombining the information from a spawned **JDF** part with the original **JDF** job, even after both documents have evolved independently. By using the mechanism for spawning and merging different parts of a job, it is possible to submit job parts to distributed controllers, devices, other work areas or other work centers.

The **JDF** spawning-and-merging mechanism can be applied recursively, which means that subjects that have already been spawned can in turn spawn other sub-subjobs and so on. However, a node SHALL NOT be re-spawned. If a node is to be spawned a second time, the previously submitted version SHALL first be deleted, and the spawning procedure SHALL be applied again to the original node.

No matter how many job parts have been spawned, however, merging is accomplished by copying nodes back to their original location and synchronizing the appropriate resources. Therefore, each spawning SHALL be logged in the job by the agent performing the actions that result in a spawned **JDF** node. Furthermore, in order to avoid inconsistent **JDF** states after merging, each merging SHALL be logged, or the appropriate *Spawned* audit element SHALL be removed from the *AuditPool* element.

► Figure 4-6: The spawning and merging mechanism and its phases shows, schematically, the spawning and merging of a subjob, designated as P.b. The following three phases are defined on a demonstrational time scale.

- 1 The first phase occurs before the subjob is spawned off.
- 2 The second phase occurs during the spawn phase, when the spawned subjob is executed separately.
- 3 The third phase occurs after the spawned **JDF** node has been merged back into the original **JDF** job.

Figure 4-6: The spawning and merging mechanism and its phases

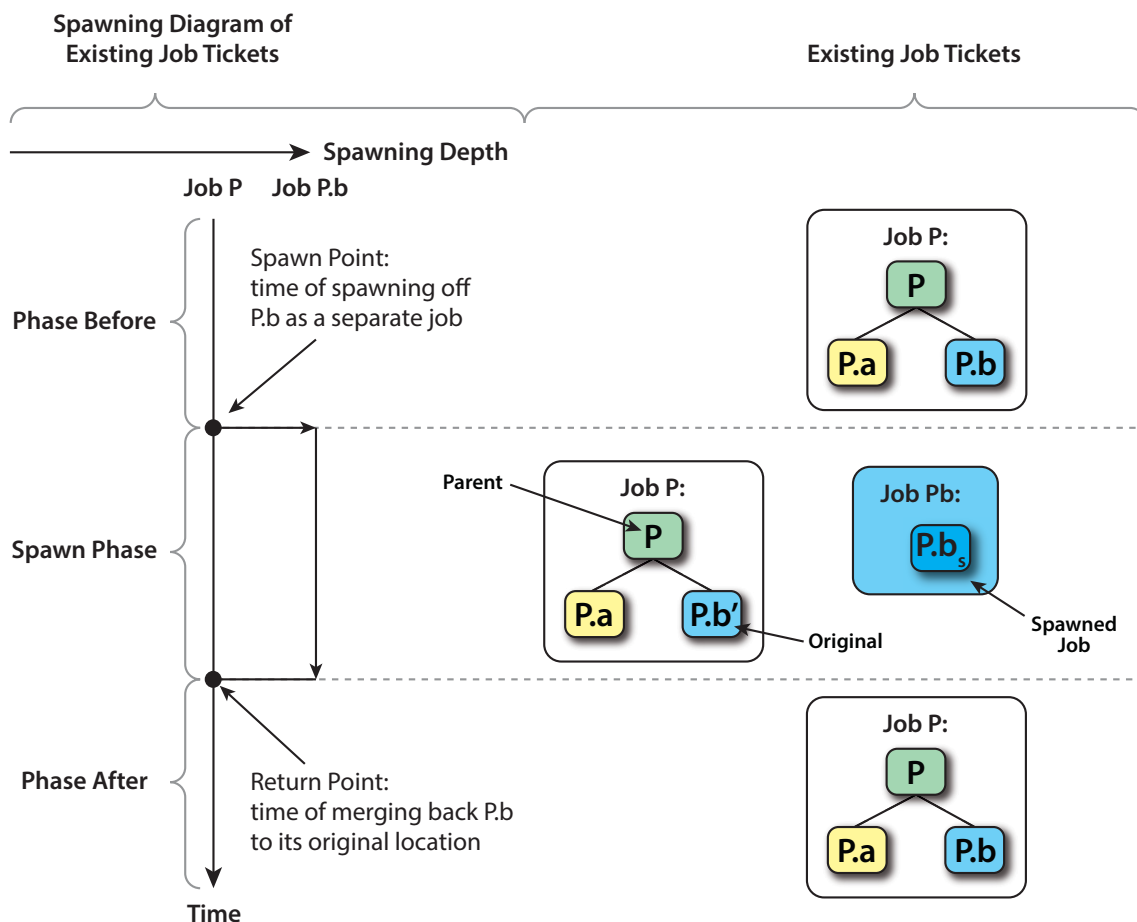

The three phases of the job part are bordered by the spawning point and the merging point. On a job scale, denoted as spawning depth in ► Figure 4-6: The spawning and merging mechanism and its phases, one job ticket exists during the phases before and after spawning, and the following two job tickets exist during the spawning phase: the job with the **parent** (P) of the **original JDF** part (P.b', also denoted as a subjob) that has been spawned; and the **spawned JDF node** (P.b_s) itself.

This section provides examples that outline the various ways in which spawning and merging can be applied. The following cases are considered in the next six sections.

- 1 Standard spawning and merging

- 2 Spawning and merging with resource copying
- 3 Parallel spawning and merging of partitioned resources
- 4 Simultaneous spawning and merging of multiple nodes

JDF can support any combination of the cases described, but these six represent a cross-section of likely scenarios. Case one is the simplest of all of the cases; it occurs in every instance of spawning and merging, regardless of the circumstances surrounding the process. Each subsequent case requires additional processing that builds upon the processing described in the cases that precede it.

4.4.1 Standard Spawning and Merging

The actions described in this case SHALL be applied in every spawning and merging process. All cases described in this chapter, as well as any other that might be invented, begin with these procedures.

Spawning

To indicate that a process has been spawned, the `@Status` attribute of the original **JDF** node SHALL be set to the value "Spawned" (see ▶ Table 3.4 JDF). The `@Status` attribute of the spawned node remains unchanged.

A unique `@SpawnID` attribute SHOULD be set in the spawned node, and a copy of its value SHOULD be set in the `@NewSpawnID` of the newly created **Spawned** audit element. This simplifies the book keeping of **Audit** elements and any subsequent merging in the case where a node is spawned multiple times, either due to error conditions or in parallel with individual partitions. The value of `@SpawnID` SHOULD also be appended to the `@SpawnIDs` list of all spawned resources.

In order to identify all of the ancestors of a job that has been spawned, an **AncestorPool** element is included in the root node of every spawned **JDF** node. This element contains an **Ancestor** element that identifies every parent, grandparent, great-grandparent, etc of the spawned subnode. In this way, the family tree of every spawned node is tracked in an ordered sequence that allows an unbroken trace back through all predecessors. Consequently, the elements that comprise the **AncestorPool** of a spawned **JDF** node SHALL be copied into the **AncestorPool** element of the newly spawned **JDF** node, before the ancestor information of the previously spawned **JDF** node is appended to the **AncestorPool** element of the newly spawned **JDF** node. The last **Ancestor** element in each **AncestorPool** is the parent, the second-to-last the grandparent, etc. **NodeInfo** and **CustomerInfo** elements or refelements MAY be copied into the respective **Ancestor** elements.

The complete ancestor information is REQUIRED in order to merge back semi-finished jobs with nested spawns. If the last spawn is always merged first ("LIFO"—Last In, First Out), then knowing the direct parent is sufficient as each parent will in turn know its own parent back to the original **JDF** node. Therefore, a complete ancestral lineage can always be inferred from any spawned node.

When a job is spawned, the action SHALL be logged in the parent node of the spawned node in the original job. This is accomplished by creating a **Spawned** element with the `@jRef` attribute set to the ID of the spawned **JDF** node. This **Spawned** element SHALL be appended to the **AuditPool** container of the original parent node. If no **AuditPool** container exists in the parent node, one SHALL be created for the purpose.

Example 4.2: Family Tree of Spawned nodes

The following code is an example of a family tree:

```
<AncestorPool>
  <Ancestor FileName="file:///grandparent.jdf" NodeID="p_01"/>
  <Ancestor FileName="file:///parent.jdf" NodeID="p_02"/>
</AncestorPool>
```

Merging

After processing, the spawned **JDF** node SHALL be merged back into its original location in the parent **JDF** node. Before this can occur, however, duplicate information contained in any elements (such as **Comment**) SHALL be deleted by the agent executing the spawning and merging. Once this has been accomplished, the spawned node is copied to the location of the original node, completely overwriting the original node. The `@Status` of the original node is then overwritten with the result.

To complete the merging process, the merging agent SHALL add a **Merged** audit element to the **AuditPool** (see ▶ Section 3.11 AuditPool and Audit). The `@MergeID` of the **Merged** audit element SHOULD be set to the value of the `@SpawnID` attribute of the merged node. Furthermore, the **AncestorPool** container with all child elements SHALL be removed, and the value of `@SpawnID` SHOULD be removed from the `@SpawnIDs` attribute of the appropriate resources.

A **JDF** agent that receives a **JDF** node that has been spawned individually, and thus has no **Part** element in the **AncestorPool**, MAY modify any elements except for resources that were spawned as read-only data.

4.4.2 Spawning and Merging with resource Copying

The following figure represents an example of a job that requires that resources be copied during spawning. In this job, the nodes B_1 and B_2 are linked to the same resource, which is localized in the **ResourcePool** of an ancestor node, denoted as node A. This node is the parent node.

Figure 4-7: JDF node structure that requires resource copying during spawning and merging

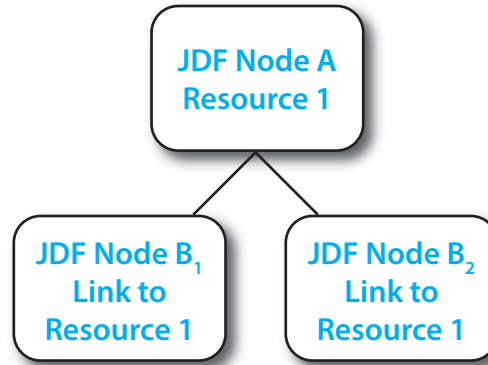

When node B_1 is spawned, its resources SHALL also be duplicated. To accomplish this, the affected resources SHALL be copied to the spawned **JDF** node and purged during merging, a process that is described below.

4.4.2.1 Spawning of resources with Inter-resource Links

Resources are linked to a node by three mechanisms.

- Explicit links defined by a **ResourceLink** in the **ResourceLinkPool** of the node.
- Implicit links defined by the **ResourceRef** elements of linked resources (implicit links are recursive).
- Implicit links defined by the **ResourceRef** elements of the **AuditPool** of the node.

A spawning or merging agent SHALL resolve all of these links by copying any non-local resources into the local **ResourcePool**.

Spawning

Spawning begins as described in Case 1. The affected resources SHALL then be copied to the **ResourcePool** of the spawned **JDF** node. The copied resources retain the same **@ID** values as the original resources. These resources can be spawned for read-only access, which allows multiple simultaneous spawning of a resource, or for read/write access, which allows only one spawning of a resource. The read/write spawning of a resource locks the resource in the original file in order to avoid conflicts that result from simultaneous modification or reading and modification of a resource. The **@SpawnStatus** attribute of the original resource SHALL be set to "**SpawnedRW**" (which stands for "spawned read/write") or "**SpawnedRO**" (which stands for "spawned read-only") to indicate that the resource is spawned. In other words, a copy of the resource is spawned together with the spawned **JDF** node. Read/write access effectively locks the original resources, just as if the attribute **@Locked = "true"**¹ were present. If a resource is spawned as read-only, it is NOT RECOMMENDED to modify the original resource that remains in the parent **JDF**, as this might lead to inconsistencies, unless the **JMF Resource Command** message is used to inform the device or controller that the resource was spawned to. The **@Locked** attribute of spawned resources that are copied read-only SHALL also be set "**true**". Furthermore, the value of the **@ID** attribute of each copied resource SHALL be appended to the appropriate **@rRefsROCopied** or **@rRefsRWCopied** values of the **Spawned** element that resides in the **AuditPool** of the parent node.

Merging

Merging begins as described in Case 1. Each Read/Write resource that has been copied for spawning SHALL be copied into its original location, completely overwriting the original resource. If any Read-only resource that has been copied for spawning is not the identical to the original resource, a **JDF** content error SHOULD be logged by a **Notification** element of **@Class="Error"** (see ▶ Section 4.6 Error Handling). The **@ID** attributes of the overwritten resources SHALL be specified in the **@rRefsOverwritten** attribute of the **Merged** element. The **Merged** element is then inserted into the **AuditPool** container of the parent during the usual merging procedure, which is shown as the return point in the spawning diagram.

4.4.3 Parallel Spawning and Merging of Partitioned resources

In many cases, it is desirable to define a parallel workflow for partitioned resources. This is modeled by spawning a node that defines the process for each part that is to be processed individually.

Spawning

Spawning begins as it did in Case 1 or Case 2. Then the spawning agent SHALL loop over all **ResourceLink** elements and ensure that the appropriate **Part** element or elements exist in any resources in the spawned ticket, where only the individual parts are REQUIRED. This is accomplished either by adding **Part** elements if none exist in **ResourceLink** elements of the parent node or by modifying the copies of existing **Part** elements. **Part** elements SHALL be included in all

1. Usually resources become locked (**@Locked = "true"**) if they are referenced by **Audit** elements (see also ▶ Section 3.11 AuditPool and Audit).

ResourceLink elements that point to resources that are spawned with write access. **Part** elements MAY be included in **ResourceLink** elements that point to resources that are spawned with read only access (e.g., **PhysicalResources** where only a part is provided to a process as input). In addition, copies of the **Part** elements are appended to the **Spawned** audit element. The **@Status** of any partitioned resource is defined individually for each partition. The **@Status** of the parent node is set to "Part" and a **NodeInfo** partition for the partition of this spawn SHALL be created. **NodeInfo/@NodeStatus** of the partition that describes the newly spawned node is set to "Spawned".

Exactly one **Part** element that contains the partition keys of this spawn and all partition keys of previous spawns SHALL be present in the **AncestorPool** of the spawned **JDF** node.

The spawning procedure described in this section can be performed iteratively for multiple parts, effectively generating one **Spawned** audit element and one **NodeInfo** partition per part. The **Spawned** and **Merged** audit elements are not placed in the parent node of the node to be spawned, but rather in the node itself.

An agent that receives a **JDF** node that has been spawned in parallel and thus has a **Part** element in the **AncestorPool** SHALL NOT modify any elements except for:

- Resources that were spawned with read-write permission, and
- Adding **Audit** elements.

Synchronizing newly inserted **JDF** subnode in spawned **JDF** nodes is OPTIONAL.

Merging

After an individual partitioned spawned node has been processed, it is merged back to the parent as described in Case 1. In addition, a copy of the **Part** elements of the corresponding **Spawned** audit element is appended to the **Merged** element and any read/write resources are merged into their appropriate parts.

4.4.4 Simultaneous Spawning and Merging of Multiple nodes

It is not possible to explicitly spawn multiple nodes simultaneously into one **JDF** job ticket. The nodes SHALL be grouped into a single process group node. This node can then be spawned and merged as described in the previous sections.

4.5 Node and Resource IDs

All nodes and resources SHALL contain a unique identifier, not only because it is important to be able to identify individual components of a job, but also because **JDF** uses these IDs for internal linking purposes. Each agent that creates resources and subnodes or that performs spawning and merging is responsible for providing IDs that are unique in the scope of the file, taking into account all of the phases of a job's life cycle.

IDs come in two flavors: pure and composite. A **pure ID** is an ID that does not contain a period character ("."). A **composite ID** is made up of pure IDs separated by periods. IDs are used differently under different circumstances. Several different circumstances are described below.

In case of no spawning. If an agent inserts new elements requiring IDs into an original job, then the agent assigns pure IDs to the new elements and SHALL guarantee their uniqueness.

In case of single spawning. If an agent inserts new elements into a spawned **JDF** node, then the agent creates composite IDs by using the ID of the root node and appending a unique pure ID delimited by a period. For example:

- ID of spawned root node: **@ID = "Job_01234.Proc1"**
- ID used for new element: **@ID = "Job_01234.Proc1.newpureID"**

In case of independent spawning. The agent that merges the independent jobs beneath a Big Job inserts a unique, pure ID (delimited by a period) in front of all IDs of each Small Job it receives. This means that the agent SHALL replace all IDs of each job it receives whenever it encounters an ID collision. If an agent inserts new elements into a spawned **JDF** node, then the agent creates composite IDs by using the ID of the respective root node of the Small Job and appends a unique pure ID, delimited by a period. For example:

- ID of the Big Job with node **@ID = "A"**
- Receives Small Job A₁ with some IDs: **@ID = "A"** **@ID = "A.A"** **@ID = "A.B"** where the first is the ID of the root node.
- Receives Small Job A₂ with some IDs: **@ID = "A"** **@ID = "A.A"** **@ID = "anything"** ...
- The agent creates locally unique pure IDs: **@ID = "A1"** and **@ID = "A2"** each prefixed to all IDs of each received Small Job; the IDs of the Small Job A₁ become: **@ID = "A1.A"** **@ID = "A1.A.A"** **@ID = "A1.A.B"**, and the IDs of the Small Job A₂ become: **@ID = "A2.A"** **@ID = "A2.A.A"** **@ID = "A2.anything"**. All IDs in the Big Job are unique.
- The agent creates a new element added to the Small Job A₁ with ID: **@ID = "A1.A.C"**. Here the agent SHALL resolve the possible conflict if it would append the pure ID = "A" to the root ID = "A1.A". That means the agent has to check the uniqueness of each created ID.
- Before merging the jobs back to their original location, the agent SHALL remove the prefixed pure IDs of all IDs, here "A1", "A2" respectively. Then the newly created element will be merged back with the **@ID = "A.C"**.

4.6 Error Handling

Error handling is an implementation-dependent feature of **JDF** based systems. The **AuditPool** element provides a container where errors that occur during the execution of a **JDF** node are to be logged using **Notification** elements.

Notification elements MAY also be sent in **JMF** messages. The content of the **Notification** element is described in ▶ Table 3.33 Notification Audit Element. For a list of predefined error codes, see ▶ Appendix C Return Values. Further details about error handling are provided in the next four sections.

4.6.1 Classification of Notifications

Notification audit elements are classified by the `@Class` attribute. Every workflow implementation SHALL associate a class with all events on an event-by-event basis. For values, see **Notification/@Class** in ▶ Section 3.11.4.5 Notification.

4.6.2 Event Description

A description of the event is given by a generic **Comment** element, which is REQUIRED for the **Notification** classes "Information", "Warning", "Error" or "Fatal". For example, after a process is aborted, error information describing a device error MAY be logged in the **Comment** element of the **Notification** element. If phase times are logged, the **PhaseTime** element that logged the transition to the "Aborted" state MAY also contain a local **Comment** element that describes the cause of the process abortion. **PhaseTime** and **Notification** elements are OPTIONAL subelements of the **AuditPool**, which is described in ▶ Section 3.11 AuditPool and Audit.

4.6.3 Error Logging in the JDF File

A **JDF** compliant controller/agent SHOULD log an error by inserting a **Notification** element in the **AuditPool** of the node that generated the error.

4.6.4 Error Handling via Messaging (JMF)

A **JMF** with a **Notification** element in the message body SHOULD be sent through all persistent channels that subscribed events of class "Error". How to subscribe error events via **JMF**, see ▶ Section 5.3.4 Persistent Channels and ▶ Section 5.19 Events.

4.7 Test Running

In **JDF**, the notion of a test run is similar to the press notion of preflight. The goal is to detect **JDF** content errors and inconsistencies in a job before the job is executed.

The ability to perform a test run MAY be built into individual devices or controllers. Alternatively, a controller implementation MAY perform test runs on behalf of its devices. A test run MAY be routed through all of the different devices and controllers in a workflow, just as if the test run were a standard execution run. For the routing of jobs and nodes through different devices and controllers for a test, the spawning and merging mechanism MAY also be applied. The devices/controllers receiving a job read and analyze it WITHOUT initiating execution. Rather, they investigate the content of the node they would execute. A device/controller with agent capabilities MAY record results into the **AuditPool** associated with a given process.

During test running, the requirements of the processes specified are compared to the capabilities of the devices targeted. A device or controller explicitly tests if the REQUIRED inputs are actually present, valid and without errors. For example, an input requirement might be a URL that, when a test run is performed, is found to point to an item that no longer exists in that location. Test running is meant to prevent errors as a result of that kind of misinformation. It is particularly useful when running expensive or time-consuming jobs.

It is also possible to test run specific parts of a workflow, or even individual nodes. An agent might request a test of certain nodes by setting the **JDF @Activation** attribute to "TestRun" (see ▶ Table 3.4 JDF), which is inherited by all descendent nodes that are not inactive (`@Activation = "Inactive"`). If a device or controller¹ detects an error in a node, a **Notification** element containing a textual description SHOULD be appended to the **AuditPool** element of the node in which the error occurred, and if messaging is supported, the error SHOULD be also communicated to the connected listeners via messaging. For more information, see ▶ Section 5.5 Error and Event Messages. If an error has been detected, the agent can modify the job in order to correct the error. Once a test run has been completed successfully, the device/controller with agent capabilities changes the `@Status` attribute of the tested node to "Ready". If a test run fails, the device/controller SHALL record the process status as "FailedTestRun". After the test run has finished, the agent SHOULD log the result by appending a **ProcessRun** element to the **AuditPool** element. For more information about **Audit** elements, see ▶ Section 3.11 AuditPool and Audit.

In principle, execution and test runs might be run simultaneously. For example, one job part could be executed while another part requests only a test. **JDF** also defines an `@Activation` value of "TestRunAndGo" that requests a test run and, upon successful completion, automatically initiates processing.

4.7.1 Resource Status During a Test Run

In order to test run a complete set of nodes, it is sometimes necessary to imply the `@Status` of resources that are produced by prior nodes. Successful test running does *not* set the `@Status` attribute of a resource to "Available" unless the resource actually is available. Nodes may assume that an input resource has `@Status="Available"`, provided that the resource is an output of another node that has completed a test run and has `@Status="Ready"`.

1. Note that only devices and controllers with agent capabilities can write in a **JDF** document.

5 Messaging

A workflow system is a dynamic set of interacting processes, devices and MIS systems. For the workflow to run efficiently, these processes and devices need to communicate and interact in a well defined manner. Messaging is a simple but powerful way to establish this kind of dynamic interaction. The **JDF** based Job Messaging Format (**JMF**) provides a wide range of capabilities to facilitate interaction between the various aspects of a workflow, from simple unidirectional notification through the issuing of direct commands. This chapter outlines the way in which **JMF** accomplishes these interactions. The following list of use cases is considered:

- System bootstrapping and setup
- Dynamic status, resource usage and error tracking for jobs and devices
- Pipe control
- Device setup and job changes
- Queue handling and job submission
- Device Capability description

Both controllers and devices MAY support **JMF**. This support requires hosting by a HTTP(S) server. **JMF** messages are most often encoded in pure XML, without an additional MIME Multipart wrapper. Only controllers that support **JDF** job submission via the message channel SHALL support MIME for messages.

JMF messaging uses a bidirectional protocol — currently HTTP and HTTPS.

JDF messaging supports combining the **JMF** message, the **JDF** job ticket(s) to which it refers, and, possibly, the digital assets to which the **JDF** job tickets refer to in a single package. See ▶ Section 11.3 JDF Packaging.

5.1 JMF

JMF and **JDF** have inherently different structures. In order to allow immediate identification of messages, **JMF** uses the unique name **JMF** as its own root-element name.

The root element of the XML fragment that encodes a message, like the root element of a **JDF** fragment, contains a series of predictable attributes and instances of **Message** elements. This content is defined in the tables that follow and are illustrated in ▶ Figure 5-1: JMF root element – a diagram of its structure. **Message** elements are abstract, as is indicated by the dashed line surrounding the **Message** element in ▶ Figure 5-1: JMF root element – a diagram of its structure.

Table 5.1: JMF Element (Sheet 1 of 2)

NAME	DATA TYPE	DESCRIPTION
<i>AgentName</i> ? New in JDF 1.4	string	The name of the agent application that generated the JMF . Both the company name and the product name MAY appear, and SHOULD be consistent between versions of the application.
<i>AgentVersion</i> ? New in JDF 1.4	string	The version of the agent application that generated the JMF . The format of the version string MAY vary from one application to another, but SHOULD be consistent for an individual application.
<i>DeviceID</i> ?	string	Identifies the recipient device or controller. If <i>@DeviceID</i> is not specified, then the recipient of the message is assumed to be the final recipient. If a controller receives a message which references a <i>@DeviceID</i> that does not match the controller's <i>@DeviceID</i> , the controller SHOULD attempt to pass the message on to the correct device. If the controller is unable to pass the message on, it SHOULD respond to the message with Message/@ReturnCode="121", "Unknown DeviceID" . If a device receives a message with a <i>@DeviceID</i> that does not match its own, it SHOULD also respond to the message with Response/@ReturnCode="121" .
<i>ICSVersions</i> ? New in JDF 1.3	NMTOKENS	CIP4 Interoperability Conformance Specification (ICS) Versions that this JMF message complies with. The semantics are identical to JDF/@ICSVersions . The value of <i>@ICSVersions</i> SHALL conform to the value format described in ▶ Section 3.2.1 ICS Versions Value.

Table 5.1: JMF Element (Sheet 2 of 2)

NAME	DATA TYPE	DESCRIPTION
<i>MaxVersion</i> ? New in JDF 1.3	enumeration	Maximum JDF version to be written by an agent that modifies this message. If not specified, an agent that responds to the message MAY write any version it is capable of writing. See ▶ Section 3.13 JDF Versioning for a discussion of versioning in JDF . Allowed value is from: ▶ JDFJMFVersion.
<i>ResponseURL</i> ? New in JDF 1.2 Deprecated in JDF 1.5 Unidirectional	URL	URL of the direct response to this JMF . <i>@ResponseURL</i> is REQUIRED when using an unidirectional protocol that does not automatically provide a response channel (e.g., the file protocol). If <i>@ResponseURL</i> is specified, a <i>ResponseTypeObj</i> is REQUIRED for the <i>Message</i> . The <i>Response</i> MAY be empty. It SHALL NOT be present when a bidirectional protocol is used (e.g., in HTTP). The URL SHALL be an explicit locator. It is up to the sending agent to generate a unique locator for the response. Example: "file://master/JMFResponseFolder/Rip1/r12345.jmf". Deprecation note: Unidirectional (file based) JMF has been deprecated.
<i>SenderID</i>	string	String that identifies the sender device, controller or agent. For a sender device, the sender's <i>@DeviceID</i> . For a sender controller, the sender's <i>@DeviceID</i> . <i>@SenderID</i> SHOULD be modified to the proxy controller's <i>@DeviceID</i> when a JMF is passed through a proxy. See also <i>Message/@SenderID</i> in ▶ Table 5.2 Message Element.
<i>TimeStamp</i>	dateTime	Time stamp that identifies when the message was created.
<i>Version</i> Modified in JDF 1.2	enumeration	Text that identifies the version of the JMF message. The current version of this specification are "1.1", "1.2", "1.3", "1.4" and "1.5". The version of a JMF message is defined by the highest version of the JMF message itself or any child element. For details on JDF versioning see ▶ Section 3.13 JDF Versioning. Note that <i>@Version</i> was OPTIONAL before JDF 1.2, but is REQUIRED in instances that conform to JDF 1.2 and beyond. If not specified, the XML schema value for <i>@Version</i> SHALL default to "1.1". Allowed value is from: ▶ JDFJMFVersion.
<i>xmlns</i> ? New in JDF 1.1	URI	JDF supports use of XML namespaces. The JDF namespace SHALL be declared. For details on using namespaces in XML, see ▶ [XMLNS].
<i>Employee</i> ? New in JDF 1.4	element	Employee who created this message.
<i>Message</i> + Modified in JDF 1.4	element	Abstract <i>Message</i> element(s). If a JMF instance includes multiple <i>Message</i> elements, the messages SHALL be executed in XML order. Modification note: Starting with JDF 1.4, <i>Message</i> order is relevant.

5.1.1 Message

The following table describes the contents of the abstract *Message* element. All messages contain an *@ID* and a *@Type* attribute.

Table 5.2: Message Element (Sheet 1 of 2)

NAME	DATA TYPE	DESCRIPTION
<i>AgentName</i> ? New in JDF 1.4	string	The name of the agent application that generated the JMF . Both the company name and the product name MAY appear, and SHOULD be consistent between versions of the application. If not specified, defaults to the value of <i>JMF/@AgentName</i> .
<i>AgentVersion</i> ? New in JDF 1.4	string	The version of the agent application that generated the JMF . The format of the version string MAY vary from one application to another, but SHOULD be consistent for an individual application. If not specified, defaults to the value of <i>JMF/@AgentVersion</i> .

Table 5.2: Message Element (Sheet 2 of 2)

NAME	DATA TYPE	DESCRIPTION
<i>ICSVersions</i> ? New in JDF 1.4	NMTOKENS	CIP4 Interoperability Conformance Specification (ICS) Versions that this JMF message complies with. The semantics are identical to <i>JDF/@ICSVersions</i> . If not specified, defaults to the value of <i>JMF/@ICSVersions</i> . The value of <i>@ICSVersions</i> SHALL conform to the value format described in ▶ Section 3.2.1 ICS Versions Value.
<i>ID</i>	ID	Identifies the message.
<i>SenderID</i> ? New in JDF 1.4	string	<i>@SenderID</i> of the original sender of this message element. If not specified, defaults to the <i>@SenderID</i> of the parent JMF . <i>@SenderID</i> SHALL NOT be modified when a JMF is passed through a proxy. See also <i>JMF/@SenderID</i> in ▶ Table 5.1 JMF Element.
<i>Time</i> ?	dateTime	Time at which the message was generated. This attribute NEED NOT be specified unless this time is different from the time specified in the <i>@TimeStamp</i> attribute of the JMF element. Note: When a proxy forwards messages and creates a new JMF parent for a message, it SHALL update <i>@Time</i> to the value of the original <i>JMF/@TimeStamp</i> if <i>@Time</i> is not provided in the original message.
<i>Type</i>	NMTOKEN	Name that identifies the message type. Message types are described in the remainder of this chapter. Values include those from: ▶ Table 5.14 List of JMF Messages.
<i>Version</i> ? New in JDF 1.4	enumeration	Text that identifies the version of the JMF message. The current version of this specification are "1.1", "1.2", "1.3" and "1.4". The version of a JMF message is defined by the highest version of the JMF message itself or any child element. For details on JDF versioning see ▶ Section 3.13 JDF Versioning. If not specified, defaults to the value of <i>JMF/@Version</i> . Allowed value is from: ▶ JDFJMFVersion.
<i>xsi:type</i> ? New in JDF 1.2	NMTOKEN	Informs schema aware validators of the JMF message type definition that the message SHALL be validated against. The schema for this version includes definitions for all the standard JMF messages defined in ▶ Section 5.6 Message Template. If omitted then a general definition for the JMF message will be used. See ▶ Section 3.2 JDF.
<i>Employee</i> ? New in JDF 1.4	element	Employee who created this message. If not specified, defaults to the value of <i>JMF/Employee</i> .

5.1.2 Structure Diagram

The following figure depicts the basic **JMF** messaging structure and the message families. Dashed boxes show abstract objects.

Figure 5-1: JMF root element – a diagram of its structure

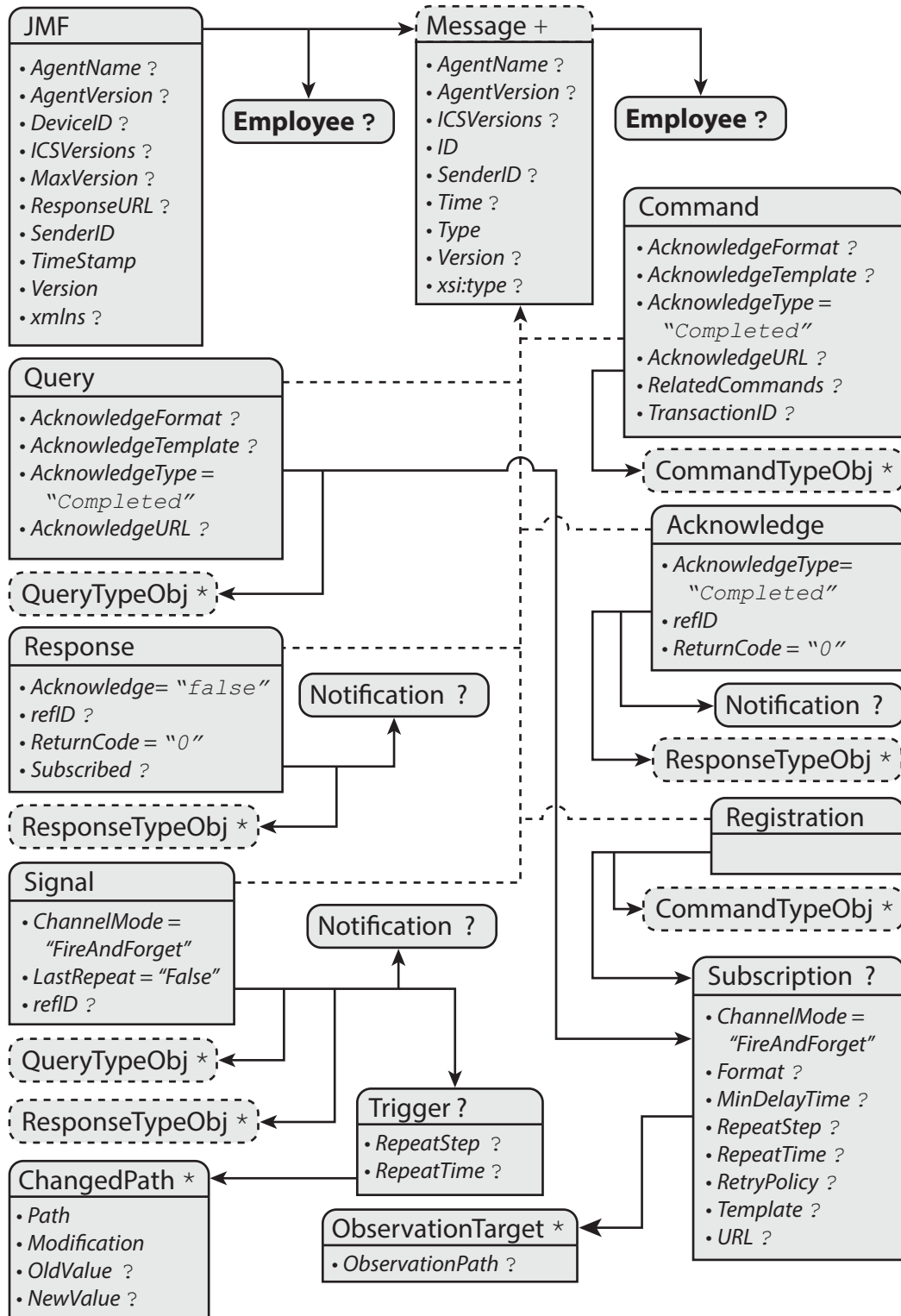

5.2 JMF Message Families

A message contains one or more of the following six high level elements, referred to as message **Families**, in the root node. These families are **Query**, **Command**, **Signal**, **Response**, **Acknowledge** and **Registration**. An explanation of each family is provided in the following sections, along with an encoding example.

5.2.1 Query

A **Query** element is used as a message that retrieves information from a controller without changing the state of that controller. A query is sent to a controller. After a **Query** message is sent, a **Response** message is returned. If the **Query** message included a **Subscription**, **Signal** messages are sent to the designated URL until a **StopPersistentChannel Command** message is sent.



Response & Acknowledgement

The terminology used for Message Families contradicts common usage but will be retained for backwards compatibility. The **Response** actually functions as an **Acknowledgement** that a **Command** will be acted upon, while the **Acknowledge** could more properly be named **Completion** or **Result**. The naming was defined to be consistent with HTTP naming conventions so that a **Response** is always transported on an HTTP response in case HTTP is used as the JMF transport protocol layer.

Figure 5-2: Interaction of messages with a subscription

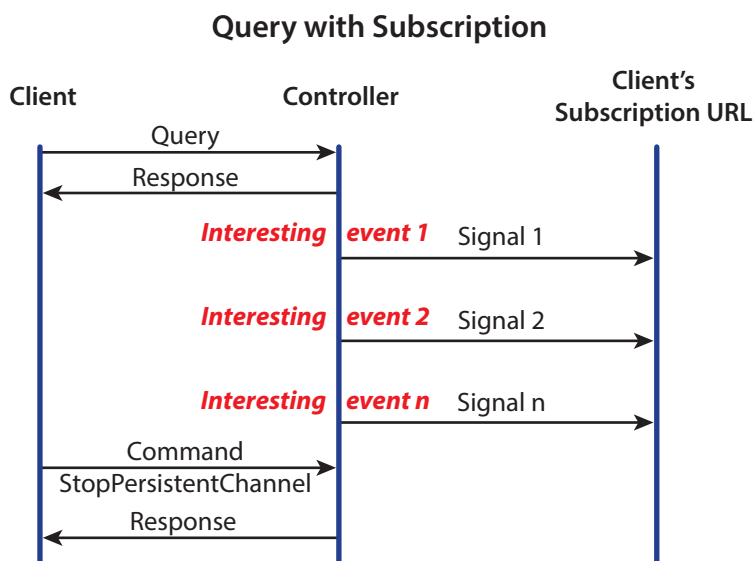

The **Query** contains an **@ID** attribute and a **@Type** attribute, which it inherits from the abstract message type described in ▶ Table 5.2 Message Element. **JMF** supports a number of well defined query types, and each query type can contain additional descriptive elements, which are described in ▶ Section 5.11 Queue Support and ▶ Section 5.16 Extending Messages. The following table shows the content of a **Query** message:

Table 5.3: Query Message Element (Sheet 1 of 2)

NAME	DATA TYPE	DESCRIPTION
<i>AcknowledgeFormat</i> ? New in JDF 1.3 Deprecated in JDF 1.5 Unidirectional	string	A formatting string used with the <i>@AcknowledgeTemplate</i> attribute to define a sequence of generated URLs. If <i>@AcknowledgeFormat</i> is specified, then <i>@AcknowledgeTemplate</i> SHALL also be specified and <i>@AcknowledgeURL</i> SHALL NOT be specified. Allowed values are from: ▶ Appendix H String Generation.
<i>AcknowledgeTemplate</i> ? New in JDF 1.3 Deprecated in JDF 1.5 Unidirectional	string	A template, used with <i>@AcknowledgeFormat</i> , to define a sequence of generated URLs. The resulting set of URLs SHALL be qualified URLs and not a folder. If <i>@AcknowledgeTemplate</i> is specified, then <i>@AcknowledgeFormat</i> SHALL also be specified and <i>@AcknowledgeURL</i> SHALL NOT be specified. Allowed values are from: ▶ Appendix H String Generation.

Table 5.3: Query Message Element (Sheet 2 of 2)

NAME	DATA TYPE	DESCRIPTION
<i>AcknowledgeType</i> = "Completed" New in JDF 1.3	enumerations	Defines the actions to be acknowledged. This is necessary mainly for device-Machine pairs where the machine is not accessible online. Allowed values are: Received – The Query has been received and understood (e.g., by an operator). Applied – The Query has been applied to the machine (e.g., by an operator). Completed – The Query has been completely responded to.
<i>AcknowledgeURL</i> ? New in JDF 1.3	URL	URL of the recipient of any Acknowledge . If specified, the command requests for an Acknowledge message depending on the value of @AcknowledgeType . The protocol of the acknowledgment is specified by the scheme of @AcknowledgeURL .
<i>QueryTypeObj</i> *	element	Abstract element that is a placeholder for any descriptive elements that provide details for the query. The element type of QueryTypeObj is defined by the @Type attribute of the abstract Message element.
<i>Subscription</i> ?	element	If Subscription is specified then a persistent channel SHALL be created. For the structure of Subscription , see ▶ Section 5.3.4 Persistent Channels.

Example 5.1: Query Message

The following is an example of a Query message:

```
<JMF MaxVersion="1.6" SenderID="Controller-1"
  TimeStamp="2005-07-25T11:38:23+02:00" Version="1.6"
  xmlns="http://www.CIP4.org/JDFSchema_1_1" xmlns:xsi="http://www.w3.org/2001/XMLSchema-instance">
  <Query ID="M007" Type="KnownDevices" xsi:type="QueryKnownDevices"/>
</JMF>
```

5.2.2 Command

A **Command** element is syntactically equivalent to a **Query**, but rather than simply retrieving information, it also causes a state change in the target device. The following table contains the contents of a **Command** message. A **Response** message is returned immediately after a **Command**. If the **Command** included an **@AcknowledgeURL**, and the **Command** was going to take a while, the device controller MAY select to return the **Response** message with **@Acknowledge="true"**, and send an **Acknowledge** message to the **@AcknowledgeURL** when the **Command** completes.

Table 5.4: Command Message Element (Sheet 1 of 2)

NAME	DATA TYPE	DESCRIPTION
<i>AcknowledgeFormat</i> ? New in JDF 1.2 Deprecated in JDF 1.5 <i>Unidirectional</i>	string	A formatting string used with the @AcknowledgeTemplate attribute to define a sequence of generated URLs. If @AcknowledgeFormat is specified, then @AcknowledgeTemplate SHALL also be specified and @AcknowledgeURL SHALL NOT be specified. Allowed values are from: ▶ Appendix H String Generation.
<i>AcknowledgeTemplate</i> ? New in JDF 1.2 Deprecated in JDF 1.5 <i>Unidirectional</i>	string	A template, used with @AcknowledgeFormat , to define a sequence of generated URLs. The resulting set of URLs SHALL be qualified URLs and not a folder. If @AcknowledgeTemplate is specified, then @AcknowledgeFormat SHALL also be specified and @AcknowledgeURL SHALL NOT be specified. Allowed values are from: ▶ Appendix H String Generation.
<i>AcknowledgeType</i> = "Completed" New in JDF 1.1	enumerations	Defines the actions to be acknowledged. This is necessary mainly for device-machine pairs where the machine is not accessible online. Allowed values are: Received – The command has been received and understood (e.g., by an operator). Applied – The command has been applied to the machine (e.g., by an operator). Completed – The command has been executed.

Table 5.4: Command Message Element (Sheet 2 of 2)

NAME	DATA TYPE	DESCRIPTION
<i>AcknowledgeURL</i> ? Modified in JDF 1.2	URL	URL of the recipient of any <i>Acknowledge</i> . If specified, the command requests for an <i>Acknowledge</i> message depending on the value of <i>@AcknowledgeType</i> . The protocol of the acknowledgment is specified by the scheme of <i>@AcknowledgeURL</i> .
<i>RelatedCommands</i> ? New in JDF 1.4	NMTOKENS	A list of <i>Command/@ID</i> values that need to be processed as a single transaction (in other words all commands needs to succeed or all need to be rejected). The commands SHALL be processed in the order specified by this attribute. This attribute SHALL only appear in the last command of a transaction. An application SHOULD wait for a reasonable amount of time to collect all related commands prior to failing a transaction.
<i>TransactionID</i> ? New in JDF 1.4	string	The ID on the transaction the command belongs to. All commands with the same <i>@TransactionID</i> SHALL either all succeed or all fail
<i>CommandTypeObj</i> *	element	Abstract element that is a placeholder for any descriptive elements that provide details of the command.

Example 5.2: ResumeQueueEntry Command Message

The following example demonstrates how a *ResumeQueueEntry* command message can cause a job in a queue to begin executing:

```
<JMF DeviceID="A3 Printer" MaxVersion="1.6" SenderID="MIS master A"
  TimeStamp="2000-07-25T12:32:48+02:00" Version="1.6"
  xmlns="http://www.CIP4.org/JDFSchema_1_1" xmlns:xsi="http://www.w3.org/2001/XMLSchema-instance">
  <Command ID="M009" Type="ResumeQueueEntry" xsi:type="CommandResumeQueueEntry">
    <QueueEntryDef QueueEntryID="job-0032"/>
  </Command>
</JMF>
```

Example 5.3: ResumeQueueEntry Response Message

The following example shows a possible *Response* message to the *Command* message example above:

```
<JMF MaxVersion="1.6" SenderID="A3 Printer"
  TimeStamp="2000-07-25T12:32:48+02:00" Version="1.6"
  xmlns="http://www.CIP4.org/JDFSchema_1_1" xmlns:xsi="http://www.w3.org/2001/XMLSchema-instance">
  <Response ID="M109" Type="ResumeQueueEntry" refID="M009" xsi:type="ResponseResumeQueueEntry">
    <Queue DeviceID="A3 Printer" Status="Full">
      <QueueEntry JobID="job-0032" QueueEntryID="job-0032" Status="Running"/>
    </Queue>
  </Response>
</JMF>
```

5.2.3 Signal

A *Signal* element is used as a message, which is equivalent to a combination of a *Query* message and a *Response* message. It is a unidirectional message sent on any event to other controllers. This kind of message can be used to automatically broadcast status changes.

Controllers can get *Signal* messages in one of three ways. The first way is to subscribe for them with an initiating query message transmitted via a message channel that includes a *Subscription* element. The second way is to subscribe for them with an initiating *Query* message defined in the *NodeInfo* element of a *JDF* node that also includes a *Subscription* element (see *JMF* elements in ▶ Section 8.94 *NodeInfo*). The first query message is transmitted separately via a mechanism such as HTTP, whereas the second is read together with the corresponding *JDF* node. Once the subscription has been established, signals are sent to the subscribing controllers via persistent channels. In both cases, however, the *Signal* message contains a *@refID* attribute that refers to the persistent channel. The value of the *@refID* attribute identifies the persistent channel that initiated the *Signal*.

The third way in which a controller can receive a signal is to have the signal channels hard-wired, for example, by a tool such as a list of controller URLs read from an initialization file. For example, signals MAY be generated independently when a service is started, or when sub-Controllers that are newly connected to a network want to inform other control-

lers of their capabilities. Hard-wired signals, however, SHALL NOT have a @refID attribute. If no @refID is specified, the corresponding query parameters SHALL be specified instead.

Table 5.5: Signal Message Element

NAME	DATA TYPE	DESCRIPTION
<i>ChannelMode</i> = "FireAndForget" New in JDF 1.4	enumeration	Specifies reliability of the signal. Allowed value is from: ▶ ChannelMode.
<i>LastRepeat</i> = "false"	boolean	If "true", the persistent channel is being closed by the device and no further messages will be generated that fulfill the persistent channel criteria. If "false", further signals will be sent. For further details, see ▶ Section 5.3.4 Persistent Channels.
<i>refID</i> ?	NMTOKEN	Identifies the initiating <i>Query</i> message that subscribed this <i>Signal</i> message. Hard-wired signals SHALL NOT contain a @refID attribute.
<i>Notification</i> * Modified in JDF 1.5	element	Textual description of the signal. The <i>Notification</i> element SHOULD be provided if the severity of the event that caused this signal is greater than "Warning", or if pure events have been subscribed. See ▶ Section 3.11.4.5 Notification. For details about subscribing pure events see ▶ Section 5.19 Events. Modification note: Starting with JDF 1.5, this element changes from optional to zero or more occurrences.
<i>QueryTypeObj</i> * Modified in JDF 1.4	element	This element is an abstract element and a placeholder for any descriptive elements that provide details for the virtual <i>Query</i> , which, if sent, would convey the same <i>ResponseTypeObj</i> elements. These element types are the same as in the <i>Query</i> message element. If the <i>QueryTypeObj</i> is required in the corresponding <i>Query</i> , it SHALL also be specified in the <i>Signal</i> , even if the <i>QueryTypeObj</i> in the subscription message referred to by @refID completely defines the context. The element type of <i>QueryTypeObj</i> is defined by the @Type attribute of the abstract <i>Message</i> element.
<i>ResponseTypeObj</i> *	element	Abstract element that is a placeholder for any descriptive elements that provide details subscribed. These element types are the same as in the <i>Response</i> message element.
<i>Trigger</i> ?	element	Describes the trigger event which caused this signal. The <i>Trigger</i> element recalls some information provided during the <i>Subscription</i> of the signal messages. For details on subscribing signals see ▶ Section 5.3.4 Persistent Channels.

5.2.3.1 Trigger

The following table describes the structure of the *Trigger* element.

Table 5.6: Trigger Element (Sheet 1 of 2)

NAME	DATA TYPE	DESCRIPTION
<i>RepeatStep</i> ?	integer	Recalls the @RepeatStep attribute specified during <i>Subscription</i> of the signal. For details see ▶ Table 5.11 Subscription Element.
<i>RepeatTime</i> ?	double	Recalls the @RepeatTime attribute specified during <i>Subscription</i> of the signal. For details see ▶ Table 5.11 Subscription Element.
<i>Added</i> ? Deprecated in JDF 1.2	element	A pool that contains the description of trigger events caused by the adding of elements like services, controllers, devices or messages. Replaced by <i>ChangedPath</i> in JDF 1.2 and above.
<i>ChangedAttribute</i> * Deprecated in JDF 1.2	element	If a change of an attribute triggered this signal, this element describes the attribute that changed. Replaced by <i>ChangedPath</i> in JDF 1.2 and above.
<i>ChangedPath</i> * New in JDF 1.2	element	If a change of an attribute or element triggered this signal, this element describes the details of the element or attribute that changed.

Table 5.6: Trigger Element (Sheet 2 of 2)

NAME	DATA TYPE	DESCRIPTION
Removed ? Deprecated in JDF 1.2	element	A pool that contains the description of trigger events caused by the removal of elements like services, controllers, devices or messages. Replaced by ChangedPath in JDF 1.2 and above.

5.2.3.2 ChangedPath

New in JDF 1.2

The following describes the structure of the **ChangedPath** element. **ChangedPath** replaces the **Added**, **ChangedAttribute** and **Removed** elements.

Table 5.7: ChangedPath Element

NAME	DATA TYPE	DESCRIPTION
Path	XPath	XPath of the element or attribute that was modified.
Modification	enumeration	Specifies the modification that occurred with the object specified in @Path . Allowed values are: Create – The object was created. Delete – The object was deleted. Modify – The object was modified.
OldValue ?	string	Old value of the attribute if @Path specifies an attribute and @Modification != "Create" . The string SHALL be cast to the appropriate data type that depends on the attribute's data type.
NewValue ?	string	New value of the attribute if @Path specifies an attribute and @Modification != "Delete" . The string SHALL be cast to the appropriate data type that depends on the attribute's data type.

Example 5.4: Signal Message

The following is an example of a Signal message:

```
<JMF MaxVersion="1.6" SenderID="Press 45"
  TimeStamp="2005-07-25T12:28:01+02:00" Version="1.6"
  xmlns="http://www.CIP4.org/JDFSchema_1_1" xmlns:xsi="http://www.w3.org/2001/XMLSchema-in-
  stance">
  <Signal ID="s123" Type="Status" xsi:type="SignalStatus">
    <StatusQuParams JobID="42" JobPartID="66"/>
    <DeviceInfo DeviceStatus="Setup"/>
  </Signal>
</JMF>
```

5.2.4 Response

A **Response** is a message that a receiver SHALL synchronously send to a sender as a response to a message. A **Response** element is used to reply to a **Query** or a **Command** and is always a direct answer of a **Query** or a **Command**. A **Response** message is returned from a controller to the controller that submitted the **Query** or **Command**; however, **Response** message(s) are not acknowledged themselves.

A **Response** message indicates that a **Query** or **Command** has been received and interpreted. The **Response** of a **Query** or **Commands** with short latency also includes the information about the execution. An **Query** or **Command** with long latency MAY additionally generate a separate **Acknowledge** message (see ▶ Section 5.2.5 Acknowledge) to broadcast the execution of the **Query** or **Command**. A **Response** SHOULD contain a **Notification** element that describes the return status in text if **@ReturnCode** is greater than 0. A **Response** contains an attribute called **@refID**, which identifies the initiating **Query** or **Command**. The following table shows the content of a **Response** message.

A **Signal** with **@ChannelMode="Reliable"** SHALL also be replied to with a **Response**.

Table 5.8: Response Message Element

NAME	DATA TYPE	DESCRIPTION
<i>Acknowledged</i> = "false"	boolean	Indicates whether the <i>Command/Query</i> will be acknowledged separately. If "true", an <i>Acknowledge</i> message will be supplied after <i>Command/Query</i> execution. If "false", no <i>Acknowledge</i> message will be supplied. If <i>@Acknowledged="true"</i> , then no additional information other than protocol information, such as <i>@AgentName</i> , <i>@ID</i> and <i>@refID</i> SHALL be specified. "Real" information SHALL only be specified in the corresponding <i>Acknowledge</i> .
<i>refID</i> ? Modified in JDF 1.2	NMTOKEN	Copy of the <i>@ID</i> attribute of the initiating <i>Query</i> message or <i>Command</i> message to which the response message refers. If not specified, the response message refers to the entire <i>JMF</i> message (e.g., if the <i>JMF</i> was not parseable). <i>Response/@Type</i> is set to "Notification" if the <i>@Type</i> of the incoming <i>Message</i> is corrupted or unknown.
<i>ReturnCode</i> = "0"	integer	The value "0" indicates success. For all other possible codes see ▶ Appendix C Return Values.
<i>Subscribed</i> ? Modified in JDF 1.2	boolean	If a <i>Subscription</i> element has been supplied by the corresponding query, this attribute indicates whether the <i>Subscription</i> has been refused or accepted. If "true", the requested <i>Subscription</i> is accepted. If "false", the <i>Subscription</i> is refused because the controller does not support persistent channels. For details, see ▶ Section 5.3.4 Persistent Channels.
<i>Notification</i> * Modified in JDF 1.5	element	Additional information including textual description of the return code. The <i>Notification</i> element SHOULD be provided if the <i>@ReturnCode</i> is greater than 0, which indicates that an error has occurred. See ▶ Section 3.11.4.5 Notification. Modification note: Starting with JDF 1.5 , this element changes from optional to zero or more occurrences.
<i>ResponseTypeObj</i> *	element	Abstract element that is a placeholder for any descriptive elements that provide details queried for or details about command execution. If <i>Response/@Acknowledged="true"</i> , <i>ResponseTypeObj</i> element(s) MAY be missing or incomplete in a <i>Response</i> .

Example 5.5: Response Message for Query

An example of a response message to a command message is provided in the ▶ Section 5.2.2 Command. The encoding example for the query message, shown above, might generate the following response message:

```
<JMF MaxVersion="1.6" SenderID="RIP-1"
  TimeStamp="2000-07-25T11:38:25+02:00" Version="1.6"
  xmlns="http://www.CIP4.org/JDFSchema_1_1" xmlns:xsi="http://www.w3.org/2001/XMLSchema-in-
stance">
  <Response ID="M107" Type="KnownDevices" refID="M007" xsi:type="ResponseKnownDevices">
    <DeviceList>
      <DeviceInfo DeviceStatus="Unknown">
        <Device DeviceID="Rip1"/>
      </DeviceInfo>
      <DeviceInfo DeviceStatus="Unknown">
        <Device DeviceID="Rip2"/>
      </DeviceInfo>
    </DeviceList>
  </Response>
</JMF>
```

5.2.5 Acknowledge

An *Acknowledge* element is a message that is an asynchronous answer to a *Command* message or *Query* message issued by a controller. Each *Acknowledge* message is unidirectional and similar to a *Response* message, and the *@refID* attribute of each refers to the initiating command. Acknowledge messages are generated if commands with long latency have been executed in order to inform the *Command* message sender of the results. Acknowledge messages are only generated if

the initiating **Command** message has specified the `@AcknowledgeURL` attribute or a pair of `@AcknowledgeFormat` and `@AcknowledgeTemplate` attributes.

Figure 5-3: Interaction of Command and Acknowledge messages

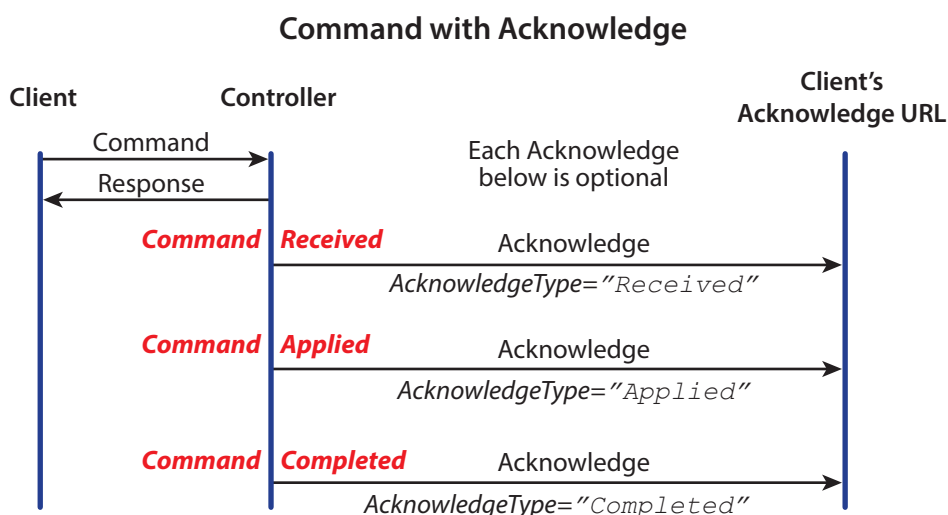

They are announced in the **Response** message to the command message by setting `@Acknowledged="true"`.

Table 5.9: Acknowledge Message Element

NAME	DATA TYPE	DESCRIPTION
<code>AcknowledgeType = "Completed"</code> New in JDF 1.1	enumerations	Defines the context of this message. This is necessary mainly for device-Machine pairs where the machine is not accessible online. Allowed values are: Received – The initiating Command has been received and understood (e.g., by an operator). Applied – The initiating Command has been applied to the machine (e.g., by an operator). Completed – The initiating Command has been executed. No further acknowledgement will be sent after an acknowledgement with <code>@AcknowledgeType="Completed"</code> has been sent.
<code>refID</code>	NMTOKEN	Identifies the initiating Command message that the Acknowledge refers to.
<code>ReturnCode = "0"</code>	integer	Describes the result. "0" indicates success. For all other possible codes see ▶ Appendix C Return Values.
<code>Notification ?</code> Modified in JDF 1.1A	element	Textual description of the command execution. See ▶ Section 3.11.4.5 Notification.
<code>ResponseTypeObj *</code>	element	Abstract element that is a placeholder for any descriptive elements that provide details about command execution. Delayed acknowledge messages contain the same ResponseTypeObj elements as direct Response messages.

Example 5.6: Acknowledge Message

The following is an example of an Acknowledge message:

```

<JMF MaxVersion="1.6" SenderID="A3 Printer"
  TimeStamp="2000-07-25T12:32:48+02:00" Version="1.6"
  xmlns="http://www.CIP4.org/JDFSchema_1_1" xmlns:xsi="http://www.w3.org/2001/XMLSchema-instance">
  <Acknowledge ID="M109" Type="PipePush" refID="M010" xsi:type="AcknowledgePipePush">
    <JobPhase JobID="J1" JobPartID="1" Status="InProgress"/>
  </Acknowledge>
</JMF>

```

5.2.6 Registration

New in JDF 1.3

A **Registration** message is a request to the recipient of the **JMF** to send **Command** messages to a command recipient who is specified in **Subscription**. See ▶ Section 5.3.4.2 Persistent Channels for Commands for details on persistent channels for commands.

Table 5.10: Registration Message Element

NAME	DATA TYPE	DESCRIPTION
CommandTypeObj *	element	Abstract elements that provide details of the Command that is setup by this Registration message.
Subscription	element	Creates a persistent channel for a command. For the structure of a Subscription element, see ▶ Section 5.3.4 Persistent Channels.

5.3 JMF Handshaking

JMF can seek to establish communication between system components in several ways. This section describes the actions and appropriate reactions in a communication using **JMF**.

5.3.1 Single Query/Command Response Communication

The handshaking mechanisms for queries and commands are equivalent. The initiating controller sends a query message or command message to the target controller. The target parses the **Query** or **Command** and immediately issues an appropriate **Response** message. If a **Command** with long latency is issued, an additional **Acknowledge** message MAY be sent to acknowledge when the command has been executed.

5.3.2 Signal and Acknowledge Handshaking

By default, **JMF** signal messages and acknowledge messages are “fire and forget.” In case of success, no response message is sent by the receiver besides the standard protocol HTTP response with an empty body. If an error occurred at the receiver's end, the **Signal** or **Acknowledge** receiver SHOULD return an error response message as defined in ▶ Section 5.5 Error and Event Messages.

Any response related to a **Signal** or **Acknowledge** message SHALL NOT specify that an acknowledge will be sent (the acknowledged attribute SHALL be set to false). This is due to the fact that signal and acknowledge messages inherently forbid the use of an acknowledge in response, since they do not have an **@AcknowledgeURL** to indicate where these acknowledge messages should be sent.

5.3.3 Reliable Signaling

If reliable signaling has been specified when the persistent channel is set up (see ▶ Table 5.11 Subscription Element), then the receiver of the **JMF** signal SHALL respond to the message using a **JMF** response that indicates the appropriate value for the **@ReturnCode** attribute. If the receiver does not respond to the reliable signal, the sender SHALL retry the reliable signal, based on the **@RetryPolicy** specified in the original **Subscription** element. If a response is received with a

@ReturnCode value other than zero, then the signal message MAY have to be retried, depending on the **Error/@Resend** attribute in the response.

Figure 5-4: Example of reliable signaling

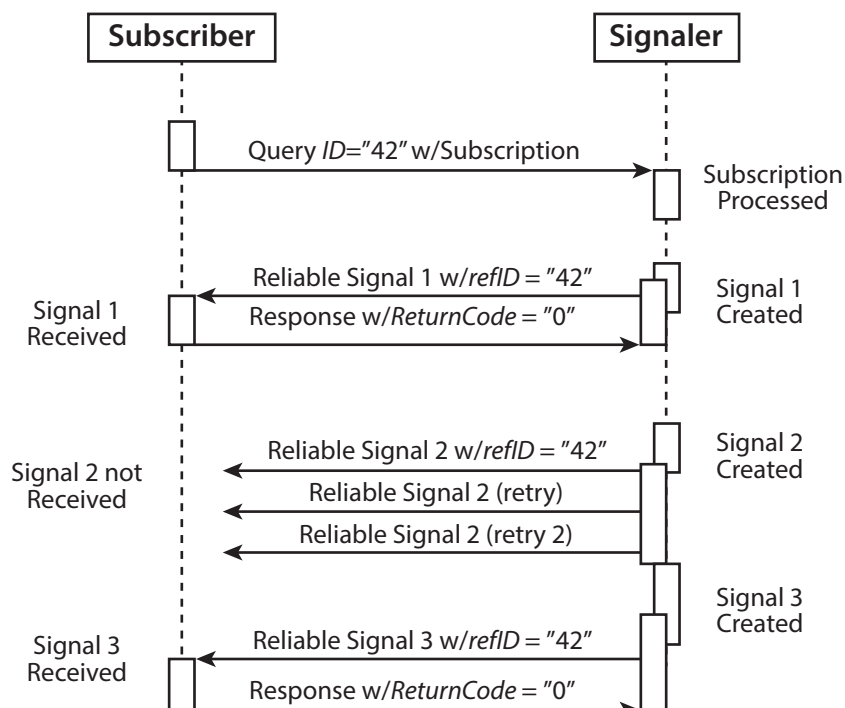

5.3.4 Persistent Channels

Query and **Command** messages are subscribed for using **Subscription** elements.

5.3.4.1 Persistent Channels for Signals

Queries are made persistent by including a **Subscription** element that defines the persistent channel–receiving end (see also ▶ Figure 5-1: JMF root element – a diagram of its structure). The responding controller SHOULD initially send a response message to the subscribing controller, then the responding controller SHOULD send signal messages whenever the condition specified by one of the attributes in the following table is true. This is referred to as a **persistent channel**. The **@refID** attribute of the **Signal** is defined by the **@ID** attribute of the **Query**. In other words, the **@refID** of the signal identifies the persistent channel. Any **Query** can be set up as a persistent channel, although in some cases this might not make sense.

5.3.4.2 Persistent Channels for Commands

New in JDF 1.3

Commands can also be subscribed for by using a **Subscription** element in an initial **Registration**. A **Subscription** in a **Registration** defines a request for the initial registration message receiver to subsequently send **Command** messages to the recipient defined in **Subscription/@URL** or **Subscription/@Format** + **Subscription/@Template**. For instance, an MIS might send a **Registration** to a prepress workflow system that directs the prepress workflow system to send **Command** messages to a press controller whenever a plate or preview has been produced.

5.3.5 Subscription

Whether or not a responding controllers implements a **JDF** persistent channel as an HTTP/1.1 ▶ [RFC2616] persistent connection depends on implementation.

Table 5.11: Subscription Element (Sheet 1 of 2)

NAME	DATA TYPE	DESCRIPTION
<i>ChannelMode</i> ? New in JDF 1.4	enumerations	Specifies reliability of persistent channel, and whether it is required or just preferred. Ordered list, with most preferred channel mode first. If none of the provided values of <i>@ChannelMode</i> are supported by the consumer of the subscription, the response SHOULD indicate <i>@ReturnCode</i> 111, which is “Subscription request denied”. Allowed value is from: ▶ ChannelMode Note: See ▶ Table 5.2.3 Signal.
<i>Format</i> ? New in JDF 1.2 Deprecated in JDF 1.5 Unidirectional	string	A formatting string used with the <i>@Template</i> attribute to define a sequence of generated URLs. Allowed values are from: ▶ Appendix H String Generation. Constraint: If <i>@Format</i> is specified, then <i>@Template</i> SHALL also be specified and <i>@URL</i> SHALL NOT be specified
<i>Languages</i> ? New in JDF 1.6	languages	List of languages selected for human readable communication. If not specified, the operating system language SHALL be used. If multiple languages are specified, the second and further languages SHOULD only be used for providing additional localized <i>Comment</i> elements. Messages SHALL NOT be sent multiple times for the same event.
<i>MinDelayTime</i> ? New in JDF 1.3	duration	Minimum delay between two subsequent <i>Signal</i> messages that are triggered by this <i>Subscription</i> . If not specified a <i>Signal</i> SHOULD be fired when any of the conditions described in <i>Subscription</i> is met. Note that <i>Signal</i> messages that would be fired before <i>@MinDelayTime</i> are lost. <i>@MinDelayTime</i> SHOULD NOT be applied to <i>Signal</i> messages that affect costing. Reliable <i>Signal</i> messages SHALL NOT be retried more frequently than the interval specified by <i>@MinDelayTime</i> .
<i>RepeatStep</i> ?	integer	Requests an update signal whenever the <i>@ActualAmount</i> associated with the query is an integer multiple of <i>@RepeatStep</i> . If not specified, it is up to the sending controller to generate signals.
<i>RepeatTime</i> ?	double	Requests an update signal every <i>@RepeatTime</i> seconds. If defined, the signal is generated periodically, independent of any other trigger conditions. <i>@RepeatTime</i> SHALL NOT override any signals triggered by a change of status. Signals triggered by a status change SHALL be sent regardless of the value of <i>@RepeatTime</i> . A sender MAY restart counting for <i>@RepeatTime</i> based signals whenever it sends a signal to the same subscription.
<i>RetryPolicy</i> ? New in JDF 1.4	enumeration	For reliable subscriptions. Indicates whether or not signals SHOULD be retried indefinitely, or only until the next signal from the same <i>Subscription</i> (i.e., has the same <i>@refID</i>) would be sent. <i>@RetryPolicy</i> is ignored for non-reliable subscriptions. Allowed values are: <i>DiscardAtNextSignal</i> – If a signal has not been received, and it is time to send the next signal related to this <i>Subscription</i> (the next signal specifies the same <i>@refID</i> value), then discard the current signal. <i>RetryForever</i> – Continue retrying every signal indefinitely.
<i>Template</i> ? New in JDF 1.2 Deprecated in JDF 1.5 Unidirectional	string	A template, used with <i>@Format</i> , to define a sequence of generated URLs. Allowed values are from: ▶ Appendix H String Generation. Constraint: if <i>@Template</i> is specified, then <i>@Format</i> SHALL also be specified and <i>@URL</i> SHALL NOT be specified.
<i>URL</i> ? Modified in JDF 1.2	URL	URL of the persistent channel receiving end. The protocol of the <i>Subscription</i> is specified by the scheme of <i>@URL</i> . Note: Starting with JDF 1.5, this attribute is no longer specified as “ <i>Bidirectional</i> ” because unidirectional attributes are deprecated.

Table 5.11: Subscription Element (Sheet 2 of 2)

NAME	DATA TYPE	DESCRIPTION
ObservationTarget *	element	Requests an updating signal message whenever the value of one of the attributes specified in ObservationTarget changes.

5.3.5.1 ObservationTarget

Table 5.12: ObservationTarget Element

NAME	DATA TYPE	DESCRIPTION
Attributes ? Deprecated in JDF 1.2	NMTOKENS	Requests an update signal whenever the value of one of the attributes specified by @Attributes is modified. A value of "*" denotes a message request for any attribute change which is the default. Deprecation note: Replaced with @ObservationPath in JDF 1.2 and above.
ElementIDs ? Deprecated in JDF 1.2	NMTOKENS	IDs of the elements that contain attributes that can change. Used only in conjunction with a query of the state change of a certain resource or node which cannot uniquely be addressed by the other attributes of this element. Deprecation note: Replaced with @ObservationPath in JDF 1.2 and above.
ElementType ? Deprecated in JDF 1.2	NMTOKEN	Name of the element that contains attributes that can change. Defaults to the abstract ResponseTypeObj of the message. Deprecation note: Replaced with @ObservationPath in JDF 1.2 and above.
ObservationPath ? New in JDF 1.2	XPath	XPath of the elements or attributes that are observed. The XPath is in the context of the resulting JMF. If not specified, a Signal is emitted on any change in the abstract ResponseTypeObj of the message.

If a controller that does not support persistent channels is queried to set up a persistent channel, it SHALL answer the query message with a response message, set **@Subscribed** to "false", and set the **@ReturnCode** to "111".

Multiple attributes of a **Subscription** element are combined as a boolean OR operation of these attributes. For instance, if **@RepeatStep** and **@ObservationTarget** are both specified, messages fulfilling either of the requirements are requested. If the **Subscription** element contains only a URL, it is up to the emitting controller to define when to emit messages.

5.3.6 Scope of Subscriptions

New in JDF 1.5.

Note: In general, subscriptions SHOULD be as global in scope as possible. For instance, it is preferable to create one global status **Subscription** for all job related and job unrelated messages, rather than creating a new status **Subscription** for each individual queue entry.

Deprecation note: Starting with JDF 1.5, support for job and queue entry specific subscriptions is deprecated.

5.3.7 Deleting Persistent Channels

A persistent channel SHALL be deleted by sending a **StopPersistentChannel** command message, as described in ▶ Section 5.56 StopPersistentChannel.

5.4 JMF Messaging Levels

A JDF conforming controller MAY opt to support one of the following messaging compliance levels offered by JMF:

- No messaging — Controllers have the option of supporting no messaging at all. For this level, JDF includes **Audit** records for each process that allow the results of the process to be recorded.
- Notification — Most controllers will choose to support some level of messaging capability. Notification is the most basic level of support. Devices that support notification provide unidirectional messaging by sending signal messages. Notification messages inform the controller when they begin and complete execution of some process within a job. They MAY also provide notice of some error conditions. Setup of the notification channel is hard-wired.
- Query support — The next level of communication supports queries. Controllers that support queries respond to requests from other controllers by communicating their status using such tools as current **@JobID** attributes, queued **@JobID** attributes or current job progress.



What's your JMF SOP?

As part of your strategic equipment purchasing procedures and requirements, consider what the JDF Messaging Levels are desired, and what the minimum level of conformance will be for your new equipment purchases.

- Command support — This level of support provides controllers with the ability to process commands. The controller can receive commands, for instance, to interrupt the current job, to restart a job, or to change the status of jobs in a queue.
- Submission support — Finally, controllers MAY accept **JDF** jobs via an HTTP post request to the messaging channel. In this case, the messaging channel SHALL support MIME Multipart/Related documents. For more details on submission, see ▶ Section 5.57 SubmissionMethods.

Each messaging level encompasses all of the lower messaging levels. Note that the message levels are provided for information and are not normative.

5.5 Error and Event Messages

If an acknowledge message, command message, query message, signal message or a registration message is not successfully handled, a processor SHALL reply with a standardized error response that may contain a **Notification** element. **Notification** elements, described in detail in ▶ Section 3.11.4.5 Notification, convey a textual description. The information contained in the **Notification** element can be used by a user interface to visualize errors.

The response messages and acknowledge messages contain a **@ReturnCode** attribute. **@ReturnCode** defaults to 0, which indicates that the response is successful. In case of success and in responses to commands, an informational **Notification** element (**@Class="Information"**) MAY be provided. In case of a warning, error or fatal error, the **@ReturnCode** is greater than 0 and indicates the kind of error committed. In this case, a **Notification** element SHOULD be provided. Error codes are defined in ▶ Appendix C Return Values. The responding application SHOULD fill additional **Notification/Error** elements that describe the details of the error.

Example 5.7: Response with Notification Element

The following example uses a **Notification** element to describe an error:

```
<JMF MaxVersion="1.6" SenderID="A3 Printer"
  TimeStamp="2005-03-25T12:32:48+02:00" Version="1.6"
  xmlns="http://www.CIP4.org/JDFSchema_1_1" xmlns:xsi="http://www.w3.org/2001/XMLSchema-in-
  stance">
  <Response ID="M109" ReturnCode="5" Type="ResumeQueueEntry"
    refID="M009" xsi:type="ResponseResumeQueueEntry">
    <Notification Class="Error" TimeStamp="2005-03-25T12:32:48+02:00" Type="Error">
      <Comment>StartJob unsuccessful - Device does not handle commands</Comment>
      <Error ErrorID="1234" Resend="Prohibited">
        <ErrorData ErrorType="Unsupported" Path="/JMF/Command"/>
      </Error>
    </Notification>
  </Response>
</JMF>
```

5.6 Message Template

The previous sections in this chapter provide a description of the overall structure of **JMF** messages. This section contains a list of the standard messages that are defined within the **JDF** framework. It is OPTIONAL for a **JDF** compliant application to support each **Signal** message or **Query** message described in this list. It is, however, possible to discover which messages are supported in a workflow. A controller responds to the **KnownMessages** query message by publishing a list of all the messages it supports (see ▶ Section 5.29 KnownMessages, below).

At the beginning of each section there is a table that lists all of the message types in that category. These tables contain three columns. The first is entitled “Message Type,” and it lists the names of each message type. The second column is entitled “Family.” The values in this (family) column describe the kind of message element that is applicable in the circumstance being illustrated. The following abbreviations are used to describe the values used in the tables below to describe these major message element types.

Note: That these are XML elements that are direct children of the **JMF** element.

C: **Command**

G: **Registration** (“G” is the third letter)

Q: **Query**

R: **Response** and **Acknowledge**

S: **Signal**

More than one of these values can be valid simultaneously. If that is the case, then all applicable letters are included in the column. Additionally, there are a few special circumstances indicated by particular combinations of these letters. The letters “QR” or “CR” indicate that all **Query** messages and **Command** messages cause a **Response** message to be returned. If the message can occur as a **Signal** message, either from a **Subscription** or independently, the “Family” field in the table also contains the letter “S”. Finally, the third column provides a description of each element.

At the beginning of each section describing the contents and function of the message types listed in the tables described above is a table containing the instantiation (i.e., the type) of all of the abstract subelements applicable to the message being described. Each table contains an entry that describes the details of the **Query** message or **Command** message as well as an additional entry that describes the details of the corresponding response. The tables resemble the following template:

Table 5.13: Template for Message tables

OBJECT TYPE	ELEMENT NAME	DESCRIPTION
Abstract subelement type of the Query or Command .	Name and type of the subelement that defines specifics of the Query message or Command message, followed by a cardinality symbol.	Short description of the subelement(s) if applicable.
Abstract subelement type of the Response or Acknowledge .	Name and type of subelement that contains specific information about the Response message or Acknowledge message to a Query message or Command message followed by cardinality symbol.	Short description of the subelement(s) if applicable.

5.6.1 Object Type Column

Each message in the remainder of this chapter has two cells in the Object Type column. The first is either **QueryTypeObj** or **CommandTypeObj**. The second is always a **ResponseTypeObj**.

5.6.1.1 QueryTypeObj

A **QueryTypeObj** is an abstract element that is a placeholder for subelements of a **Query** or **Signal** message. See **Query/QueryTypeObj** (▶ Table 5.3 Query Message Element) and **Signal/QueryTypeObj** (▶ Table 5.5 Signal Message Element). **QueryTypeObj** also appears in the first row of the Object Type column for each query message below. For each such query message, the corresponding elements in the Element Name column are intended to replace the **QueryTypeObj** in **Query/QueryTypeObj** or **Signal/QueryTypeObj**.

5.6.1.2 CommandTypeObj

A **CommandTypeObj** is an abstract element that is a placeholder for subelements of a **Command** or **Registration** message. See **Command/CommandTypeObj** (▶ Table 5.4 Command Message Element) and **Registration/CommandTypeObj** (▶ Table 5.10 Registration Message Element). **CommandTypeObj** also appears in the first row of the Object Type column for each Command message below. For each such Command message, the corresponding elements in the element Name column are intended to replace the **CommandTypeObj** in **Command/CommandTypeObj** or **Registration/CommandTypeObj**.

5.6.1.3 ResponseTypeObj

A **ResponseTypeObj** is an abstract element that is a placeholder for subelements of a **Response**, **Signal** or **Acknowledge** message. See **Response/ResponseTypeObj** (▶ Table 5.8 Response Message Element), **Signal/ResponseTypeObj** (▶ Table 5.8 Response Message Element) and **Acknowledge/ResponseTypeObj** (▶ Table 5.9 Acknowledge Message Element). **CommandTypeObj** also appears in the second row of the Object Type column for each message below. For each such message, the corresponding elements in the Element Name column are intended to replace the **ResponseTypeObj** in the **Response/ResponseTypeObj**, **Signal/ResponseTypeObj** or **Acknowledge/ResponseTypeObj**.

5.7 List of All JMF Messages

Table 5.14: List of JMF Messages (Sheet 1 of 3)

MESSAGE TYPE	FAMILY	DESCRIPTION
AbortQueueEntry	CR	The QueueEntry is aborted and remains in the Queue with QueueEntry/@Status="Aborted" .
CloseQueue	CR	The queue is closed. No Jobs are to be accepted by the queue.
Events Deprecated in JDF 1.5	QRS	Used to subscribe pure events occurring randomly like scanning of a bar code, activation of function keys at a console, error messages, etc.
FlushQueue	CQRS	All entries in the queue are removed.
FlushResources New in JDF 1.2	CQRS	Remove temporary Resource from a Device.

Table 5.14: List of JMF Messages (Sheet 2 of 3)

MESSAGE TYPE	FAMILY	DESCRIPTION
ForceGang New in JDF 1.3	CR	A gang is forced to execute.
GangStatus New in JDF 1.3	CR	The status of a gang is queried.
HoldQueue	CR	The queue is held. No Jobs within the queue are to be executed.
HoldQueueEntry	CR	The entry remains in queue but is not executed until a ResumeQueueEntry Command message is received.
KnownControllers Deprecated in JDF 1.5	QRS	Returns a list of JMF capable controllers.
KnownDevices	QRS	Returns information about the Devices that are controlled by a Controller.
KnownJDFServices Deprecated in JDF 1.2	QRS	Returns a list of services (JDF Node Types) that are defined in the JDF specification.
KnownMessages	QRS	Returns a list of all messages that are supported by the Controller.
KnownSubscriptions New in JDF 1.4	QRS	Returns a list of active persistent channels.
ModifyNode New in JDF 1.3	CRS	modifies details of JDF Nodes.
NewJDF New in JDF 1.2	CQRS	Initiates or reports modifications of new JDF Nodes.
NodeInfo New in JDF 1.2 Deprecated in JDF 1.3	CQRS	Initiates or reports modifications of JDF Node information (e.g., scheduling).
Notification	S	Used to signal usual events due to any activities of a Device, operator, etc. (e.g., scanning a bar code).
Occupation Deprecated in JDF 1.5	QRS	Queries the occupation of an employee.
OpenQueue	CR	The queue is opened. Jobs are to be accepted.
PipeClose	CR	Closes a pipe because no further Resources are needed. This is typically used to terminate the producing Process.
PipePause	CR	Pauses a Process if no further Resources can be consumed or produced.
PipePull	CR	Requests a new Resource from a pipe.
PipePush	CR	Notifies that a new Resource is available in a pipe.
QueueEntryStatus Deprecated in JDF 1.2	QRS	Returns a QueueEntry element.
QueueStatus	QRS	Returns the Queue elements that describe a queue or set of queues.
RemoveQueueEntry	CR	A job is removed from the queue.
RepeatMessages Deprecated in JDF 1.5	QR	Returns a set of previously sent messages that have been stored by the Controller.

Table 5.14: List of JMF Messages (Sheet 3 of 3)

MESSAGE TYPE	FAMILY	DESCRIPTION
RequestForAuthentication New in JDF 1.4	CQRS	Used as a Command to exchange certificates or as a Query to obtain the authentication status of previously exchanged certificates.
RequestQueueEntry New in JDF 1.2	CR	A new job is requested by the Device. This message is used to signal that a Device has processing Resources available.
Resource	CGQRS	Queries and/or modifies JDF Resources that are used by a Device, such as Device settings, or by a job. This message can also be used to query the level of Consumable Resource elements in a Device.
ResourcePull New in JDF 1.2	CGR	Creates a new QueueEntry from an already existing QueueEntry and submits it to the queue in order to be executed.
ResubmitQueueEntry	CR	Replaces a queue entry without affecting the entry's parameters. The command is used, for example, for late changes to a submitted JDF .
ResumeQueue	CR	The queue is activated and queue entries are to be executed.
ResumeQueueEntry	CR	A held job is resumed. The job is re-queued at the position defined by its current priority. Submission time is set to the current time stamp.
ReturnQueueEntry New in JDF 1.2	CR	Returns a job that had been submitted with a SubmitQueueEntry to the queue that represents the Controller that originally submitted the job.
SetQueueEntryPosition	CR	Queues a job behind a given position n, where n represents a numerical value. "0" is the pole position. Priority is set to the priority of the job at position n.
SetQueueEntryPriority	CR	Sets the priority of a queued job to a new value. This does not apply to Jobs that are already running.
ShutDown New in JDF 1.2	CR	Shuts down a Device.
Status	QRS	Queries the general status of a Device, Controller or job.
StopPersistentChannel	CR	Closes a persistent channel.
SubmissionMethods	QR	Queries a list of supported submission methods to the queue.
SubmitQueueEntry	CR	A job is submitted to a queue in order to be executed.
SuspendQueueEntry New in JDF 1.2	CR	The entry is suspended if it is already running. It remains suspended until a ResumeQueueEntry Command message is received.
Track Deprecated in JDF 1.5	QRS	Queries the location of a given job or job Part.
UpdateJDF New in JDF 1.3	CRS	Synchronizes and relinks modified JDF Nodes.
WakeUp New in JDF 1.2	CR	Wakes up a Device that is in standby mode.

5.8 Messages for Events and Capabilities

The message types of the following table are defined in order to exchange metadata about Controller or Device abilities and for general communication.

Table 5.15: Messages for events and capabilities (Sheet 1 of 2)

MESSAGE TYPE	FAMILY	DESCRIPTION
Events Deprecated in JDF 1.5	QRS	Used to subscribe pure events occurring randomly like scanning of a bar code, activation of function keys at a console, error messages, etc.

Table 5.15: Messages for events and capabilities (Sheet 2 of 2)

MESSAGE TYPE	FAMILY	DESCRIPTION
KnownControllers Deprecated in JDF 1.5	QRS	Returns a list of JMF capable Controllers.
KnownDevices	QRS	Returns information about the Devices that are controlled by a Controller.
KnownJDFServices Deprecated in JDF 1.2	QRS	Returns a list of services (JDF Node Types) that are defined in the JDF specification.
KnownMessages	QRS	Returns a list of all messages that are supported by the Controller.
KnownSubscriptions New in JDF 1.4	QRS	Returns a list of active persistent channels.
Notification	QRS	Generally sent as Signals. A Query allows Subscriptions for Notification messages.
RepeatMessages Deprecated in JDF 1.5	QR	Returns a set of previously sent messages that have been stored by the Controller.
RequestForAuthentication New in JDF 1.4	CQR	Used as a Command to exchange certificates or as a Query to obtain the authentication status of previously exchanged certificates.
StopPersistentChannel	CR	Closes a persistent channel.

5.9 Messages to Query/Command a Job, Device or Controller

JDF Messaging provides methods to trace the status of individual devices and resources, and additional job-dependent job-tracking data. The status of a job is described by the **Status** elements of that job.

Devices are uniquely identified by a *name* — that is, by the attribute **@DeviceID** of the **Device** Resource (see ▶ Section 8.4.4, Device) — while Controllers are uniquely identified by their URL. In other words, Controllers are implicitly identified as a result of the fact that they are responding to a message. One Controller MAY control multiple Devices. The following queries and commands are defined for status and progress tracking.

Table 5.16: Messages to query/affect a Job, Device or Controller (Sheet 1 of 2)

MESSAGE TYPE	FAMILY	DESCRIPTION
FlushResources New in JDF 1.2	CQRS	Remove temporary Resources from a Device.
ModifyNode New in JDF 1.3	CRS	Modifies details of JDF Nodes that have previously been submitted to a Device.
NewJDF New in JDF 1.2	CQRS	Initiates or reports modifications of new JDF Nodes.
NodeInfo New in JDF 1.2 Deprecated in JDF 1.3	CQRS	Initiates or reports modifications of JDF Node information (e.g., scheduling). Use either Resource Command messages with ResourceCmdParams/@ResourceName="NodeInfo" or Resource Query messages with ResourceQuParams/@ResourceName="NodeInfo" instead.
Occupation Deprecated in JDF 1.5	QRS	Queries the occupation of an employee. Deprecation note: Use Status signals with JobPhase/Activity or DeviceInfo/Activity instead.
Resource	CGQRS	Queries and/or modifies JDF Resources that are used by a Device, such as Device settings, or by a job. This message can also be used to query the level of consumables in a Device.
ResourcePull New in JDF 1.2	CGR	Creates a new QueueEntry from an already existing QueueEntry and submits it to the queue in order to be executed.

Table 5.16: Messages to query/affect a Job, Device or Controller (Sheet 2 of 2)

MESSAGE TYPE	FAMILY	DESCRIPTION
ShutDown New in JDF 1.2	CR	Shuts down a Device.
Status	QRS	Queries the general status of a Device, Controller or job.
Track Deprecated in JDF 1.5	QRS	Queries the location of a given job or job Part.
UpdateJDF New in JDF 1.3	CRS	Synchronizes and relinks modified JDF Nodes.
WakeUp New in JDF 1.2	CR	Wakes up a Device that is in standby mode.

5.10 Messages for Pipe Control

JDF Messaging provides methods to control dynamic pipes. Dynamic pipes are described in detail in ▶ Section 4.3.3 Overlapping processing Using Pipes.

Table 5.17: Messages for Control of Dynamic Pipes

MESSAGE TYPE	FAMILY	DESCRIPTION
PipeClose	CR	Closes a pipe because no further Resources are needed. This is typically used to terminate the producing Process.
PipePause	CR	Pauses a Process if no further Resources can be consumed or produced.
PipePull	CGR	Requests a new Resource from a pipe.
PipePush	CGR	Notifies that a new Resource is available in a pipe.

5.10.1 Common PipeControl Element

5.10.1.1 PipeParams

The **PipeParams** element is also used by the messages **PipePull**, **PipePush** and **PipePause**.

Table 5.18: PipeParams Element (Sheet 1 of 2)

NAME	DATA TYPE	DESCRIPTION
JobID ? New in JDF 1.2	string	Specifies the @JobID of the process at the receiving end of the message that links to the resource specified in @PipeID .
JobPartID ? New in JDF 1.2	string	Specifies the @JobPartID of the process at the receiving end of the message that links to the resource specified in @PipeID .
PipeID	string	Pipe ID of the JDF resource that defines the dynamic pipe.
ProjectID ? New in JDF 1.5	string	Specifies the @ProjectID of the Node at the receiving end of the message that links to the Resource specified in @PipeID .
Status = "InProgress"	enumeration	Process status after the request. Allowed values are from: ▶ Status.
UpdatedStatus ?	enumeration	This value represents the actual status of the pipe resource and MAY be used by the receiving process for process termination control. For details see ▶ Section 4.3.5.2 Formal Iterative processing. Allowed values are from: ▶ ResourceStatus.
AmountPool ? New in JDF 1.5	element	Updated AmountPool for the pipe Resource. The AmountPool/PartAmount/Part MAY contain additional metadata related to the updated Resource. The ordering of the PartAmount elements in the AmountPool is relevant.

Table 5.18: PipeParams Element (Sheet 2 of 2)

NAME	DATA TYPE	DESCRIPTION
Resource *	element	Updated resources to be used by the process that receives the pipe command: PipePull (the receiver creates the pipe Resource), PipePush (the receiver consumes the pipe Resource) and PipePause (the receiver only updates the inputs). Possible commands are: PipePull , PipePush or PipePause . In case of the PipeClose Command message, the Resources are ignored. The data type and @Class of Resource is derived from the Abstract Resource. See ▶ Section 3.8.3 Abstract Resource.
ResourceLink ? Deprecated in JDF 1.5	element	Updated ResourceLink to the pipe Resource: PipePull (it is an output link), PipePush (it is an input link) and PipePause (depends on the pipe end). This ResourceLink MAY be used by the Process that links to the pipe Resource. The attributes @rRef and @Usage of a ResourceLink SHALL NOT be modified by the Agent that sends the Pipe Control message because these attributes are used by the JMF receiver to identify the ResourceLink that is to be modified. In case of the PipeClose Command message, the ResourceLink is ignored. Deprecation note: Starting with JDF 1.5 , AmountPool replaces ResourceLink . This change allows for amounts and partitions without using @rRef and @Usage . The Resource is identified by @PipeId .

5.11 Queue Support

In **JMF**, a Controller or Device is assumed to have one input queue that accepts submitted Jobs. Controllers which receive submitted jobs SHALL in turn submit these jobs to lower level controllers or devices to further pass the submission on. In other words, job submissions “cascade” down through controllers until they get to the device. Similarly, **ReturnQueueEntry** messages “cascade” back up through each level. If a machine supports multiple queues, it SHALL be represented by multiple logical devices in **JDF**. In other words, a Device SHALL NOT have more than one queue. The simple case of a device with no queue can be mapped to a queue with two **@Status** states: “Waiting” and “Full”. **JMF** supports simple handling of priority queues. The following assumptions are made:

- Queues support priority. Priority SHALL only be changed for waiting Jobs. A queue MAY round priorities to the number of supported priorities, which MAY be one, indicating no priority handling.
- Priority is described by an integer from 0 to 100. Priority 100 defines a job that SHOULD pause another job that is in progress and commence immediately. If a Device does not support the pausing of running Jobs, it SHOULD queue a priority 100 job before the last pending priority 100 job.
- A controller MAY control multiple devices/queues.
- Queue entries can be unambiguously identified by a **@QueueEntryID**.
- A controller or device MAY analyze a **JDF** that is submitted to a queue at submission or execution time. A queue MAY treat a **JDF** as a closed envelope that is passed on to the device without checking. The behavior is implementation dependent.

Some conventions used in the following sections have already been introduced in ▶ Section 5.6 Message Template. This affects the message families and the descriptive tables at the beginning of each message section that describe the type objects related to the corresponding message. The type objects are **QueryTypeObj**, **CommandTypeObj** and **ResponseTypeObj** (see also ▶ Figure 5-1: JMF root element – a diagram of its structure).

5.11.1 Queue Entry ID Generation

Queue entries are accessed using a **@QueueEntryID** attribute, which the queue’s controller or device generates when it receives the submitted job, and which is returned in the **SubmitQueueEntry** response message. **@QueueEntryID** SHALL uniquely identify an entry within the scope of one queue. An implementation is free to choose the algorithm that generates **@QueueEntryID** values.

5.12 Messages for Queue Entry Handling

Queue-entry handling is provided so that the state of individual jobs within a queue can be changed. Job submission, queue-entry grouping, priorities, and hold / suspend / resume of entries are all supported. The individual commands are defined in the table and explained in greater detail in the sections that follow.

Starting with **JDF 1.5**, the **Queue** element is deprecated in the response to all queue entry handling messages. The **QueueFilter** that limits the **Queue** is also deprecated in the respective commands and queries. The status of the resulting queue SHOULD therefore be queried with an explicit **QueueStatus** message. See ▶ Section 5.41 **QueueStatus**.

Table 5.19: Messages for queue entry handling

MESSAGE TYPE	FAMILY	DESCRIPTION
AbortQueueEntry Modified in JDF 1.2	CR	The QueueEntry is aborted and remains in the Queue with QueueEntry/@Status="Aborted" .
HoldQueueEntry	CR	The entry remains in queue but is not executed until a ResumeQueueEntry Command message is received.
RemoveQueueEntry	CR	A job is removed from the queue.
RequestQueueEntry New in JDF 1.2	CR	A new job is requested by the Device. This message is used to signal that a Device has processing capabilities available.
ResubmitQueueEntry	CR	Replaces a queue entry without affecting the entry’s parameters. The command is used, for example, for late changes to a submitted JDF .
ResumeQueueEntry	CR	A held job is resumed. The job is re-queued at the position defined by its current priority. Submission time is set to the current time stamp.
ReturnQueueEntry New in JDF 1.2	CR	Returns a job that had been submitted with a SubmitQueueEntry to the queue that represents the Controller that originally submitted the job.
SetQueueEntryPosition	CR	Queues a job behind a given position n, where n represents a numerical value. "0" is the pole position. Priority is set to the priority of the job at position n.
SetQueueEntryPriority	CR	Sets the priority of a queued job to a new value. This does not apply to Jobs that are already running.
SubmitQueueEntry	CR	A job is submitted to a queue in order to be executed.
SuspendQueueEntry New in JDF 1.2	CR	The entry is suspended if it is already running. It remains suspended until a ResumeQueueEntry Command message is received.

The following table specifies the status transitions for the respective queue entry handling messages. The error(n) indicates the ReturnCode which is returned on an illegal Status transition and the queue entry Status is unchanged. For details on error codes, see ▶ Appendix C Return Values.

The following are codes for the following table:

- A:** Aborted
- C:** Completed
- H:** Held
- PR:** PendingReturn *New in JDF 1.4*
- Rm:** Removed
- Rn:** Running
- S:** Suspended
- W:** Waiting

number: Error that specified number (e.g., “105” means “error(105)”).

Table 5.20: Status Transitions for QueueEntry Handling Messages (Sheet 1 of 2)

PREVIOUS STATUS MESSAGE TYPE	NON-EXISTENT	W	H	RN	S	PR	C	A
AbortQueueEntry	105	A	A	A	A	114	114	113
HoldQueueEntry	105	H	113	106	106	114	114	114
RemoveQueueEntry	105	Rm	Rm	106	106	106	Rm	Rm
ResumeQueueEntry	105	113	W	113	R/W	114	114	114
SetQueueEntryPosition	105	W	H	107	107	114	114	114

Table 5.20: Status Transitions for QueueEntry Handling Messages (Sheet 2 of 2)

PREVIOUS STATUS MESSAGE TYPE	NON-EXISTENT	W	H	RN	S	PR	C	A
<i>SetQueueEntryPriority</i>	105	W	H	107	107	114	114	114
<i>SuspendQueueEntry</i>	105	115	115	S	113	114	114	114
<i>RequestQueueEntry</i>	<i>RequestQueueEntry</i> is emitted by the Controller of the queue and not sent to the queue. Therefore it is not applicable in this section.							
<i>ResubmitQueueEntry</i>	105	W	H	Rn + W + 107	S + 107	114	Rn + W + 114	Rn + W + 114
<i>ReturnQueueEntry</i>	<i>ReturnQueueEntry</i> is emitted by the Controller of the queue and not sent to the queue. Therefore it is not applicable in this section.							
<i>SubmitQueueEntry</i>	W,H, Rn	A new <i>@QueueEntryID</i> is generated by the queue owner on submission. Therefore these states are not applicable.						

The following @Status transition diagram depicts the life cycle of a queue entry.

Figure 5-5: JMF QueueEntry status transition diagram

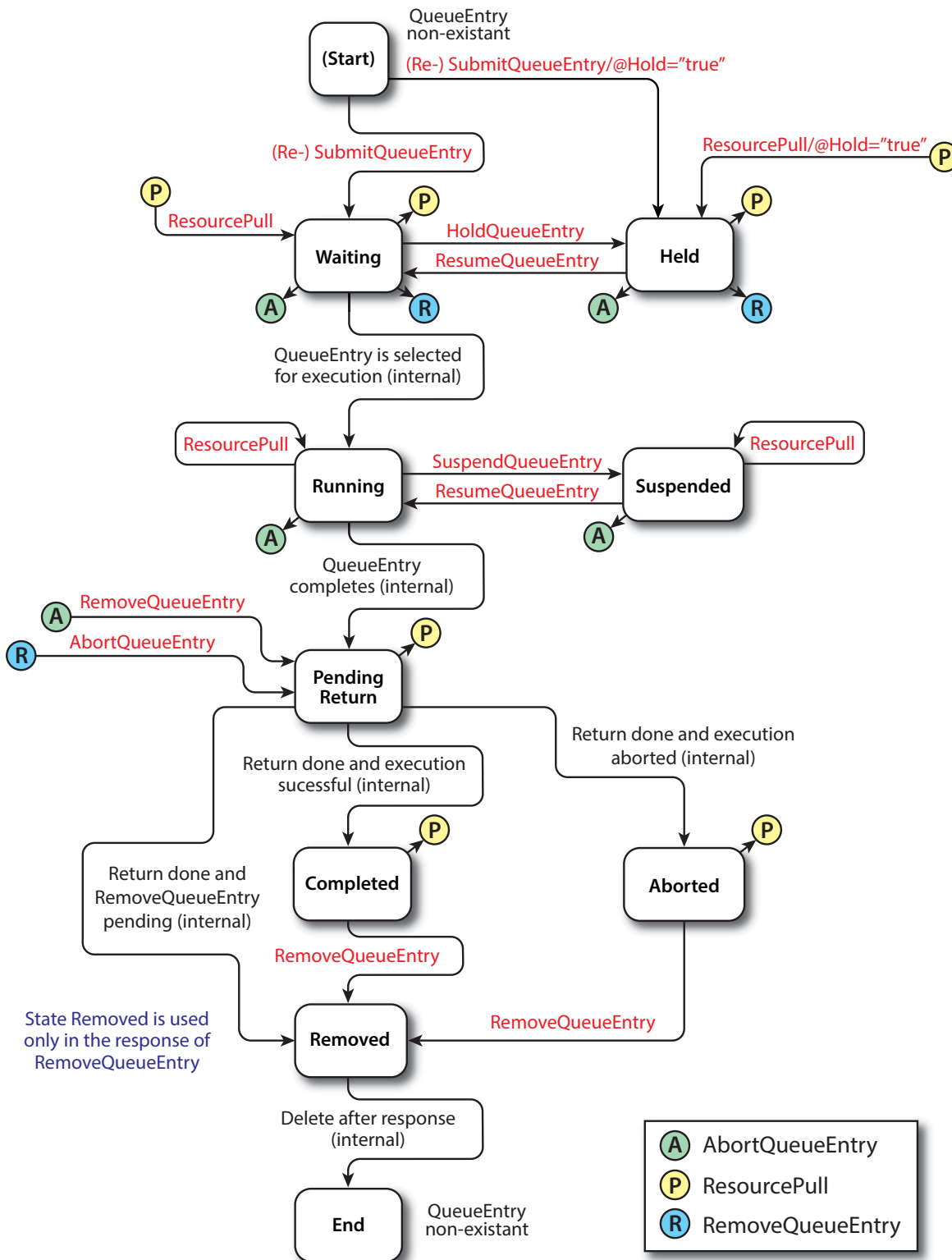

5.13 Messages for Global Handling of Queues

Whereas the commands in the preceding section change the state of an individual queue entry, the commands in this section modify the state of an entire queue. Note that entries that are executing in a Device are not affected by the global queue-handling commands and SHALL be accessed individually. An individual queue can be selected by specifying the target Device in the @DeviceID attribute of the JMF Root. If no @DeviceID is specified, the commands or queries are ap-

plied to all queues that are controlled by the Controller that received the message. The following individual messages are defined:

Table 5.21: Messages for global handling of queues

MESSAGE TYPE	FAMILY	DESCRIPTION
FlushQueue	CQRS	All entries in the queue are removed.
SubmissionMethods	QR	Queries a list of supported submission methods to the queue.
CloseQueue	CR	The queue is closed. No Jobs are to be accepted by the queue.
FlushQueue	CQRS	All entries in the queue are removed.
HoldQueue	CR	The queue is held. No Jobs within the queue are to be executed.
OpenQueue	CR	The queue is opened. Jobs are to be accepted.
QueueEntryStatus Deprecated in JDF 1.2	QRS	Returns a QueueEntry element.
QueueStatus	QRS	Returns the Queue element that describes a queue.
ResumeQueue	CR	The queue is activated and queue entries are to be executed.
SubmissionMethods	QR	Queries a list of supported submission methods to the queue.

The following table shows the resulting status of a [Queue](#) in dependence on global queue commands [CloseQueue](#)/[OpenQueue](#) and [HoldQueue](#)/[ResumeQueue](#) as well as the load of a queue and its processor. The first command pair determines the logical state of the first column “Closed” and the second of the column “Held”. The [Queue](#) is held if the [Queue](#) manager doesn't send existing entries to the [Queue](#)'s processor.

Table 5.22: Definition of the Queue Status Attribute Values

CLOSED	HELD	QUEUE FULL	PROCESSOR FULL	STATUS
Yes	Yes	Any	Any	"Blocked"
Yes	No	Any	Any	"Closed"
No	Yes	Any	Any	"Held"
No	No	Any	No	"Waiting"
No	No	No	Yes	"Running"
No	No	Yes	Yes	"Full"

Figure 5-6: Effects of the global queue messages on the queue status

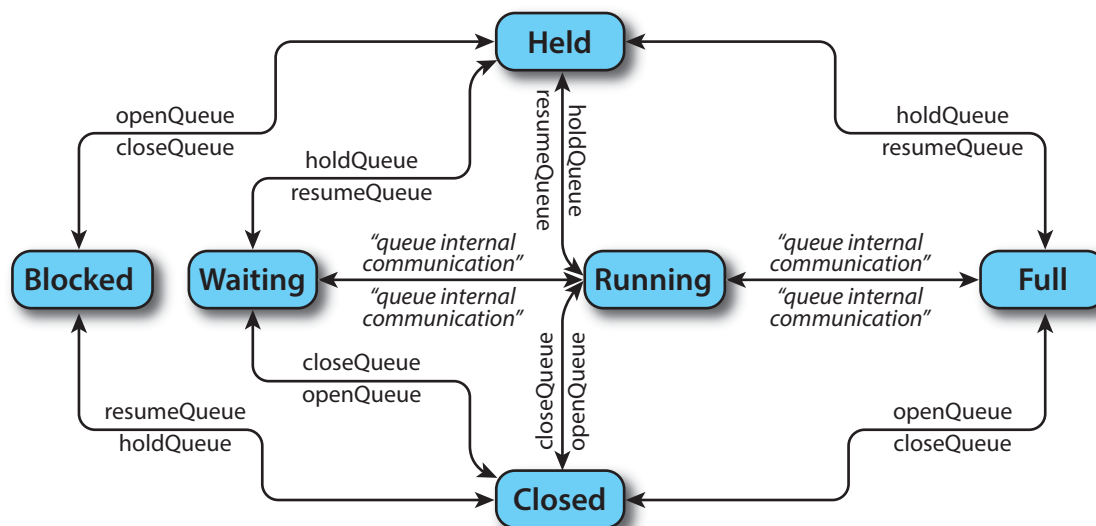

5.13.1 QueueEntryStatus

Deprecated in JDF 1.2

Deprecation note: Starting with JDF 1.2, use [QueueStatus](#) with an appropriate [QueueFilter](#) instead of [QueueEntryStatus](#).

5.14 Elements for Queues

In this section elements used by queue-handling commands are defined.

5.14.1 Queue

The attributes in the following table are defined for [Queue](#) message elements. [Queue](#) elements represent the queue of a device including [QueueEntry](#) elements that represent both pending and running queue entries.

Table 5.23: Queue Element (Sheet 1 of 2)

NAME	DATA TYPE	DESCRIPTION
DeviceID	string	Identifies the device that is represented by the queue.
MaxQueueSize ? New in JDF 1.6	integer	The maximum number of QueueEntry elements excluding QueueEntry [@Status="Completed"] or QueueEntry [@Status="Aborted"] elements that can be contained in the Queue .
QueueSize ? New in JDF 1.2 Modified in JDF 1.6	integer	The total number of QueueEntry elements that are in the Queue regardless of the settings in the QueueFilter . Thus the value of @QueueSize may be higher than the number of QueueEntry elements.
Status	enumeration	Status of the queue. Allowed values are: Blocked – Queue is completely inactive. Entries SHALL NOT be added and no entries are executed. The queue is closed and held. The queue requires an interaction like OpenQueue or ResumeQueue to reactivate it. Closed – Queue entries that are in the queue are executed, but new entries SHALL NOT be submitted. The lock SHALL be removed explicitly by the OpenQueue Command message. Full – Queue entries that are in the queue are executed but new entries SHALL NOT be submitted. The lock is removed by the queue Controller as soon as it is able to do so. Running – A Process is executing. Entries can be submitted and will be executed when they reach their turn in the queue. Waiting – Queue accepts new entries and has free Resources to immediately commence processing. Held – Entries can be submitted but will not be executed until the queue is resumed by the ResumeQueue Command message.

Table 5.23: Queue Element (Sheet 2 of 2)

NAME	DATA TYPE	DESCRIPTION
Device *	element	The Devices that execute entries in this queue. Only Device / <i>@DeviceID</i> SHOULD be specified in these Device elements.
QueueEntry * Modified in JDF 1.2	element	<p>QueueEntry elements (see ▶ Table 5.24 QueueEntry Element, below). The entries SHALL be ordered in the sequence they have been or will be executed in, beginning with the running entries, followed by the waiting entries, highest QueueEntry/<i>@Priority</i> first, which are then followed by the completed entries, sorted beginning with the youngest QueueEntry/<i>@EndTime</i>. The Queue contains a list of all QueueEntry elements that are still accessible on the Device using the queue entry handling messages that are defined in ▶ Table 5.24 QueueEntry Element.</p> <p>A QueueEntry is not automatically deleted when executed or aborted, but rather it remains in the Queue and its <i>@Status</i> is changed to "Completed" or "Aborted" accordingly. QueueEntry[<i>@Status</i>="Completed" or <i>@Status</i>="Aborted"] elements SHALL NOT count towards determining Queue/<i>@Status</i> based on the number of QueueEntry elements versus the <i>@MaxQueueSize</i>.</p>

Example 5.8: Queue Element

```
<Queue DeviceID="Q12345" Status="Running">
  <QueueEntry JobID="111" JobPartID="0" Priority="1"
    QueueEntryID="111-0" Status="Completed"/>
  <QueueEntry JobID="111" JobPartID="1" Priority="1"
    QueueEntryID="111-1" Status="Running"/>
  <QueueEntry JobID="111" JobPartID="2" Priority="1"
    QueueEntryID="111-2" Status="Waiting"/>
  <QueueEntry JobID="112" JobPartID="1" Priority="55"
    QueueEntryID="112-1" Status="Held"/>
</Queue>
```

5.14.2 QueueEntry

Table 5.24: QueueEntry Element (Sheet 1 of 2)

NAME	DATA TYPE	DESCRIPTION
Activation ? New in JDF 1.5	enumeration	Specifies the activation of the requested QueueEntry . Allowed value is from: ▶ Activation.
DeviceID ? New in JDF 1.2	string	Identification of the Device that the QueueEntry will be or was executed on. If not specified, it defaults to the default Device of the queue.
EndTime ? New in JDF 1.2	dateTime	Time when the job has been ended.
GangName ? New in JDF 1.3	NMTOKEN	Name of the gang that this QueueEntry belongs to. <i>@GangName</i> SHALL be specified, if the QueueEntry is a candidate member of a gang job.
GangPolicy ? New in JDF 1.3	enumeration	Ganging policy for the QueueEntry . Allowed value is from: ▶ GangPolicy
JobID ? Modified in JDF 1.1	string	The <i>@JobID</i> of the JDF Process.
JobPartID ?	string	The <i>@JobPartID</i> of the JDF Process.
Priority = "1"	integer	Priority of the QueueEntry . Values are 0-100."0" is the lowest priority, while "100" is the highest priority.
QueueEntryID	string	ID of a QueueEntry . This ID SHALL be generated by the queue owner.

Table 5.24: QueueEntry Element (Sheet 2 of 2)

NAME	DATA TYPE	DESCRIPTION
<i>StartTime</i> ? New in JDF 1.1	dateTime	Time when the job has been started.
<i>Status</i> Modified in JDF 1.3	enumeration	Status of the individual entry. Allowed values are from: ▶ QueueEntryStatus.
<i>StatusDetails</i> ? New in JDF 1.5	string	<i>@StatusDetails</i> provides additional details on the status of the <i>QueueEntry</i> . Values include: <i>HeldForResourcePull</i> – When <i>@Status</i> is "PendingReturn", job is not returned on purpose, commands <i>ResourcePull</i> , <i>RemoveQueueEntry</i> or <i>AbortQueueEntry</i> are possible <i>JobUserInputRequired</i> – When <i>@Status</i> is "Waiting" or "Running", job is not producible and waits for user input required to process further (e.g., missing parameters, decisions, etc.) <i>JobMissResources</i> – When <i>@Status</i> is "Waiting" or "Running", job waits for resources to become available to process further <i>JobReadyForStart</i> – When is <i>@Status</i> "Waiting" or "Running", job is ready and waits for (manual) start event to process further <i>QueuedToRun</i> – When <i>@Status</i> is "Waiting" or "Running", job is queued to run and waits for device to become available (idle) to process further <i>PendingReturn</i> – When <i>@Status</i> is "PendingReturn", job is currently returning (explicit "PendingReturn" to distinguish from devices/controllers that do not support <i>@StatusDetails</i>) <i>Running</i> – When <i>@Status</i> is "Running", job is processing (explicit Running to distinguish from devices/controllers that do not support <i>@StatusDetails</i>)
<i>SubmissionTime</i> ?	dateTime	Time when the entry was submitted to the queue.
<i>GangSource</i> * New in JDF 1.6	element	If present, each <i>GangSource</i> SHALL represent the source jobs that are being processed as a gang job by this <i>QueueEntry</i> .
<i>JobPhase</i> * New in JDF 1.2	element	Description of the current status of the job that is associated with the <i>QueueEntry</i> . Note that in JDF 1.3 and above, one <i>QueueEntry</i> MAY have multiple active <i>JobPhase</i> elements.
<i>Part</i> * New in JDF 1.2	element	Describes which parts of a job were submitted to the queue. The <i>Part</i> elements are copies of <i>AncestorPool/Part</i> of the JDF Node that is executed by the Device.
<i>Preview</i> * New in JDF 1.2	element	Any number of <i>Preview</i> elements MAY be associated with a <i>QueueEntry</i> and used for display purposes. <i>Preview/@PreviewUsage</i> SHOULD be "ThumbNail" or "Viewable".

5.14.3 QueueEntryDef

The element specifies a queue entry and is used to refer to a certain queue entry.

Table 5.25: QueueEntryDef Element

NAME	DATA TYPE	DESCRIPTION
<i>QueueEntryID</i>	string	ID of the queue entry. The ID is generated by the queue owner.

5.14.4 QueueFilter

New in JDF 1.2

The *QueueFilter* element defines a filter for all messages that return a queue. The supplied elements of the *QueueFilter* define a matching criteria that is a logical "and". Only *QueueEntry* elements that match all restrictions specified by the

QueueFilter are included in the **Queue** element that is returned by the queue-handling message. The **QueueFilter** element is also used to specify the **QueueEntry** elements to be removed by the **FlushQueue** message.

Table 5.26: **QueueFilter** Element (Sheet 1 of 2)

NAME	DATA TYPE	DESCRIPTION
Activation ? New in JDF 1.5	enumeration	The activation state of the QueueEntry elements to be returned. If not specified, there is no filtering on QueueEntry / @Activation . Allowed value is from: ▶ Activation.
FirstEntry ? New in JDF 1.6	string	@QueueEntryID of the first QueueEntry that this QueueFilter applies to. Only QueueEntry elements that are behind this (including this) QueueEntry in the current queue sorting SHALL be selected
GangNames ? New in JDF 1.3	NMTOKENS	Gang names of the QueueEntry elements to be returned. If not specified, there is no filtering on QueueEntry / @GangName .
JobID ? New in JDF 1.4	string	Return only QueueEntry elements with specified @JobID . If not specified, there is no filtering on QueueEntry / @JobID .
JobPartID ? New in JDF 1.4	string	Return only QueueEntry elements with specified @JobPartID . If not specified, there is no filtering on QueueEntry / @JobPartID .
LastEntry ? New in JDF 1.6	string	@QueueEntryID of the last QueueEntry that this QueueFilter applies to. Only QueueEntry elements that are in front of this (including this) QueueEntry in the current queue sorting SHALL be selected
MaxEntries ?	integer	Maximum number of QueueEntry elements to provide in the Queue element. If not specified, fill in all matching QueueEntry elements.
MaxPriority ? New in JDF 1.6	integer	Only QueueEntry elements with a @Priority lower than or equal to the value of @MaxPriority SHALL be provided in the Queue element. If not specified, there is no @Priority upper bound on candidates.
MinPriority ? New in JDF 1.6	integer	Only QueueEntry elements with a @Priority higher than or equal to the value of @MinPriority SHALL be provided in the Queue element. If not specified, there is no @Priority lower bound on candidates.
NewerThan ?	dateTime	Only QueueEntry elements with a @SubmissionTime newer than or equal to this dateTime SHALL BE provided in the Queue element or removed by the FlushQueue message. If not specified, there is no dateTime upper bound on candidates.
OlderThan ?	dateTime	Only QueueEntry elements with a @SubmissionTime older than or equal to this dateTime SHALL BE provided in the Queue element or removed by the FlushQueue message. If not specified, there is no dateTime lower bound on candidates.
PreviewUsages ? New in JDF 1.4	enumerations	Specifies the particular kind (or kinds) of Preview resources to return in QueueEntry/Preview . If @PreviewUsages is empty or not supplied, the QueueEntry element SHALL not contain any Preview resources. The Preview resources returned in a QueueEntry are a subset of those in the actual QueueEntry defined by: QueueEntry/Preview [contains (QueueFilter / @PreviewUsages , @PreviewUsage)] Allowed values are from: ▶ PreviewUsage.

Table 5.26: QueueFilter Element (Sheet 2 of 2)

NAME	DATA TYPE	DESCRIPTION
<i>QueueEntryDetails</i> = "Brief" Modified in JDF 1.4	enumeration	<p>@<i>QueueEntryDetails</i> refines the level of provided information about the queue.</p> <p>allowed values are:</p> <p>None – Do not fill in the <i>QueueEntry</i> elements into the queue.</p> <p>Brief – Provide all available <i>QueueEntry</i> information except for the associated <i>JobPhase</i> element.</p> <p>JobPhase – Provide all available <i>QueueEntry</i> information including the associated <i>JobPhase</i> elements. <i>JobPhase/@URL</i> MAY be returned when <i>@QueueEntryDetails</i>="JobPhase".</p> <p>JDF – Provide all available <i>QueueEntry</i> information including the associated <i>JobPhase</i> element and the associated JDF element in the <i>JobPhase</i> element. Deprecated in JDF 1.4</p> <p>Deprecation note: Starting with JDF 1.4, use the <i>Status</i> query to retrieve status information including information about the current JDF.</p>
<i>StatusList</i> ?	enumerations	<p>Only <i>QueueEntry</i> elements with a <i>@Status</i> matching one of the entries in <i>@StatusList</i> SHALL be selected by this filter. If not specified, there is no filtering on <i>QueueEntry/@Status</i>.</p> <p>Allowed values are from: ▶ <i>QueueEntryStatus</i>.</p>
<i>UpdateGranularity</i> ? New in JDF 1.4	enumeration	<p>Specifies whether all or only the updated <i>QueueEntry</i> elements should be included in the <i>Queue</i>.</p> <p>Allowed values are:</p> <p>All – The <i>Queue</i> element describes all <i>QueueEntry</i> elements.</p> <p>ChangesOnly – The <i>Queue</i> element describes only those <i>QueueEntry</i> elements that have new information since the last <i>Queue</i> element was sent. When used in conjunction with a signal, the <i>Queue</i> element describes all jobs on the first instance of the signal being sent.</p>
<i>Device</i> *	element	<p>Only <i>QueueEntry</i> elements that match the attribute values specified in one of these <i>Device</i> resources SHALL be included. <i>QueueEntry</i> elements match the criteria if the attribute values specified in one of these <i>Device</i> resource match the equivalent attribute values of the devices that are processing the <i>QueueEntry</i>. Unspecified attributes always match. If <i>Device</i> is not specified, all <i>QueueEntry</i> elements are returned. As this is a filter, only information that can be used to identify a <i>Device</i> SHALL be specified. This precludes use of <i>DeviceCap</i> and <i>IconList</i> in this <i>Device</i>.</p>
<i>GangSource</i> * New in JDF 1.6	element	<p>If present only <i>QueueEntry</i> elements that contain a <i>GangSource</i> element that matches at least one of these <i>GangSource</i> elements SHALL be selected. If not specified, there is no filtering based on <i>GangSource</i>.</p>
<i>Part</i> * New in JDF 1.4	element	<p>Only <i>QueueEntry</i> elements with all specified <i>Part</i> elements SHALL BE returned. If not specified, there is no filtering on <i>QueueEntry/Part</i>.</p>
<i>QueueEntryDef</i> *	element	<p>Defines an explicit list of queue entries. If not specified, all entries in the <i>Queue</i> are considered.</p>

5.15 Gang Jobs

New in JDF 1.3

JMF provides a mechanism to specify groups of *QueueEntry* elements within a queue that are processed together in a gang. A job is submitted to a gang by specifying *QueueSubmissionParams/@GangPolicy*. The details of how individual job parts are ganged are device specific. For a description of planned job ganging, see also ▶ Section 6.3.38 SheetOptimizing.

Table 5.27: Messages for Gang Jobs

MESSAGE TYPE	FAMILY	DESCRIPTION
<i>ForceGang</i> New in JDF 1.3	CR	A gang is forced to execute.
<i>GangStatus</i> New in JDF 1.3	CR	The status of a gang is queried.

5.16 Extending Messages

This specification defines a set of predefined messages for general usage. Extensions to existing messages and additional message types can be defined using the standard extension rules described in ▶ Section 3.12 JDF Extensibility. Note, the generic content of ▶ Section 3.1 Generic Contents of All Elements is also valid for **JMF** elements. It is not allowed to define message extensions which duplicate the functionality of messaging types, messaging elements or message attributes that are already defined in this specification.

For example the content of the `@Type` attribute MAY be specified with a prefix that identifies the organization that defined the extension. The prefix and name SHOULD be separated by a single colon (':'). Any additional attributes and elements are allowed, and internal elements MAY be declared with explicit namespaces. The official namespace of **JMF** elements is `@xmlns="http://www.CIP4.org/JDFSchema_1_1"`. This namespace is identical to that defined for **JDF** in ▶ Section 3.12 JDF Extensibility. An example is provided:

Example 5.9: Custom Query

```
<JMF MaxVersion="1.6" SenderID="Circus"
  Timestamp="2005-07-25T12:32:48+02:00" Version="1.6"
  xmlns="http://www.CIP4.org/JDFSchema_1_1"
  xmlns:Circus="Circus Schema URI" xmlns:xsi="http://www.w3.org/2001/XMLSchema-instance">
  <Query ID="Q1" Type="Circus:IsClownHappy" xsi:type="QueryIsClownHappy">
    <Circus:ClownParams Gender="male"/>
  </Query>
</JMF>
```

Example 5.10: Custom Response

The response message will also have the "Circus:" namespace identifier. All **Circus** elements are explicitly declared.

```
<JMF MaxVersion="1.6" SenderID="Circus 2"
  Timestamp="2005-07-25T12:32:48+02:00" Version="1.6"
  xmlns="http://www.CIP4.org/JDFSchema_1_1"
  xmlns:Circus="Circus Schema URI" xmlns:xsi="http://www.w3.org/2001/XMLSchema-instance">
  <Response ID="M1" Type="Circus:IsClownHappy" refID="Q1" xsi:type="ResponseIsClownHappy">
    <Circus:Clown happy="true" name="Joe"/>
    <Circus:Clown happy="false" name="John"/>
  </Response>
</JMF>
```

5.16.1 IfraTrack Support

The extending mechanism can be used to implement compatibility with other XML-based messaging standards, for example version 3.0 of IfraTrack. The `@Type` attribute is set to the appropriate namespace, and the foreign message is included, as demonstrated in the following example:

Note: The application is free to select the appropriate response types in order to fulfill its local (IfraTrack) protocol requirements if it uses its own namespace. In the examples below, the default namespace associated with the **JMF** query message and response elements has been overwritten by the Ifra namespace.



More on IfraTrack

IfraTrack is a specification for the interchange of status and management information between local and global production management systems in newspaper production.

Example 5.11: Custom Query for IfraTrack

```
<JMF MaxVersion="1.6" SenderID="IFRA"
  TimeStamp="2003-07-25T12:32:48+02:00" Version="1.6"
  xmlns="http://www.CIP4.org/JDFSchema_1_1" xmlns:IFRA="IfraTrack URI" xmlns:xsi="http://
www.w3.org/2001/XMLSchema-instance">
  <Query ID="Q1" Type="IFRA:IMF" xsi:type="QueryIMF">
    <imf:IMF xmlns:imf="IfraTrack URI">Whatever you want (might be multiple top level Elements)</
imf:IMF>
  </Query>
</JMF>
```

Example 5.12: Custom Response for IfraTrack

The legal response message would be:

```
<JMF MaxVersion="1.6" SenderID="IFRA"
  TimeStamp="2003-07-25T12:32:48+02:00" Version="1.6"
  xmlns="http://www.CIP4.org/JDFSchema_1_1" xmlns:IFRA="IfraTrack URI" xmlns:xsi="http://
www.w3.org/2001/XMLSchema-instance">
  <Response ID="M1" Type="IFRA:IMF" refID="Q1" xsi:type="ResponseIMF">
    <imf:IMF xmlns:imf="IfraTrack URI">The appropriate IFRA response(s)</imf:IMF>
  </Response>
</JMF>
```

5.17 AbortQueueEntry

Once this command is issued, the entry specified by [AbortQueueEntryParams/QueueFilter](#) is stopped or aborted and remains in the [Queue](#) with [QueueEntry/@Status="Aborted"](#) or ["Completed"](#) depending on the value of [AbortQueueEntryParams/@EndStatus](#). The [Audit](#) elements and [JDF/@Status](#) of the processing [JDF](#) node are to be appropriately set to ["Aborted"](#) or ["Completed"](#) and the [JDF](#) node SHALL be delivered to the URL as specified by [SubmitQueueEntry/@ReturnURL](#), [SubmitQueueEntry/@ReturnJMF](#) or [NodeInfo/@TargetRoute](#).

Table 5.28: AbortQueueEntry Message

OBJECT TYPE	ELEMENT NAME	DESCRIPTION
CommandTypeObj Modified in JDF 1.2 Modified in JDF 1.5	AbortQueueEntryParams ? New in JDF 1.5	
	QueueEntryDef Deprecated in JDF 1.5	Defines the queue entry or set of queue entries. Deprecation note: Starting with JDF 1.5 , this QueueEntryDef SHOULD be located in AbortQueueEntryParams/QueueFilter .
	QueueFilter ? New in JDF 1.2 Deprecated in JDF 1.5	Defines a filter for the returned Queue elements in the AbortQueueEntry message.
ResponseTypeObj Modified in JDF 1.5	Queue Deprecated in JDF 1.5	Describes the state of the queue after the command has been executed.

For the definition of the elements listed above, see ▶ Section 5.14 Elements for Queues.

5.17.1 AbortQueueEntryParams

New in JDF 1.5

Table 5.29: AbortQueueEntryParams Element

NAME	DATA TYPE	DESCRIPTION
<i>EndStatus</i>	enumeration	End status of the job after completing processing. Allowed values are: Completed Aborted
<i>QueueFilter</i> ?	element	This <i>QueueFilter</i> selects the <i>QueueEntry</i> elements to apply this message to.

Example 5.13: AbortQueueEntry Command

The following example demonstrates how an *AbortQueueEntry* command message causes a job in a queue to be aborted and only return the @*Status* of the aborted *QueueEntry* in the response, rather than the entire *Queue*:

```
<Command ID="M009" Type="AbortQueueEntry" xsi:type="CommandAbortQueueEntry">
  <QueueEntryDef QueueEntryID="job-0032"/>
  <QueueFilter>
    <QueueEntryDef QueueEntryID="job-0032"/>
  </QueueFilter>
</Command>
```

Example 5.14: AbortQueueEntry Response

The following example shows a possible response message to the command message example above:

```
<Response ID="M109" Type="AbortQueueEntry" refID="M009" xsi:type="ResponseAbortQueueEntry">
  <Queue DeviceID="A3 Printer" Status="Running">
    <QueueEntry JobID="job-0032" QueueEntryID="job-0032" Status="Aborted"/>
  </Queue>
</Response>
```

5.18 CloseQueue

The queue is closed. No further queue entries are accepted by the queue. The status of entries that are already in the queue remains unchanged and entries that are already in the *Queue* MAY be executed.

Table 5.30: CloseQueue Message

OBJECT TYPE	ELEMENT NAME	DESCRIPTION
<i>CommandTypeObj</i> Modified in JDF 1.5	<i>QueueFilter</i> ? New in JDF 1.2 Deprecated in JDF 1.5	Defines a filter for the returned <i>Queue</i> element in the <i>CloseQueue</i> message.
<i>ResponseTypeObj</i> Modified in JDF 1.5	<i>Queue</i> Deprecated in JDF 1.5	Describes the state of the queue after the command has been executed.

5.19 Events

Deprecated in JDF 1.5

Starting with JDF 1.5, the functionality of *Events* can be achieved using a subscription to *Notification* messages.

5.20 FlushQueue

5.20.1 FlushQueue Command

FlushQueue Command is used to remove *QueueEntry* elements from the *Queue*.

Note: A *QueueEntry* is not automatically deleted when executed or aborted, but rather it remains in the *Queue* and its @*Status* is changed to "Completed" or "Aborted" accordingly. *FlushQueueParams* allows the specification of which

QueueEntry elements to remove. The *QueueFilter* in the *FlushQueue* message is applied to the *Queue* returned after the command is executed. The *QueueFilter* contained within the *FlushQueueParams* is used to specify which *QueueEntry* elements to remove.

Table 5.31: *FlushQueue* Command Message

OBJECT TYPE	ELEMENT NAME	DESCRIPTION
<i>CommandTypeObj</i> Modified in JDF 1.5	<i>FlushQueueParams</i> ? New in JDF 1.2	Defines the <i>QueueEntry</i> elements to be removed. If not specified, then only pending (i.e., @Status="Waiting" and @Status="Held" queue entries are removed).
	<i>QueueFilter</i> ? New in JDF 1.2 Deprecated in JDF 1.5	Defines a filter for the returned <i>Queue</i> element in the <i>FlushQueue</i> message.
<i>ResponseTypeObj</i> Modified in JDF 1.5	<i>FlushQueueInfo</i> ? New in JDF 1.2	Defines the <i>QueueEntry</i> elements that were removed.
	<i>Queue</i> Deprecated in JDF 1.5	Describes the state of the queue after the command has been executed.

5.20.1.1 *FlushQueueParams*

New in JDF 1.2

Table 5.32: *FlushQueueParams* Element

NAME	DATA TYPE	DESCRIPTION
<i>QueueFilter</i> ?	element	Defines a <i>QueueFilter</i> that specifies the <i>QueueEntry</i> elements to be removed. If not specified, the <i>Queue</i> is completely flushed.

5.20.2 *FlushQueue* Query

When used as a signal or query, *FlushQueue* Query allows a controller to monitor queue flushing that is initiated by the device (e.g., due to resource constraints). The *QueueFilter* in the *FlushQueue* message is applied to the *Queue* returned after the command is executed. The *QueueFilter* contained within the *FlushQueueInfo* is used to specify which *QueueEntry* elements were removed.

Table 5.33: *FlushQueue* Query Message

OBJECT TYPE	ELEMENT NAME	DESCRIPTION
<i>QueryTypeObj</i> Modified in JDF 1.5	<i>FlushQueueParams</i> New in JDF 1.5	Defines a <i>QueueFilter</i> that specifies the <i>QueueEntry</i> elements to be removed. If not specified, the <i>Queue</i> is completely flushed.
	<i>QueueFilter</i> ? Deprecated in JDF 1.5	Defines a filter for the returned <i>Queue</i> element in the <i>FlushQueue</i> message.
<i>ResponseTypeObj</i> Modified in JDF 1.5	<i>FlushQueueInfo</i> ? New in JDF 1.2	Defines the <i>QueueEntry</i> elements that were removed.
	<i>Queue</i> Deprecated in JDF 1.5	Describes the state of the queue after the elements have been flushed.

5.20.2.1 *FlushQueueInfo*

New in JDF 1.2

The [QueueFilter](#) in [FlushQueueParams](#) defines the [QueueEntry](#) elements to be removed by [FlushQueue](#). Those [QueueEntry](#) elements meeting the criteria set in the [QueueFilter](#) will be removed.

Table 5.34: [FlushQueueInfo](#) Element

NAME	DATA TYPE	DESCRIPTION
QueueFilter	element	Defines a QueueFilter that specifies the QueueEntry elements that were removed. Typically QueueFilter contains a set of QueueEntryDef elements that specify the QueueEntry elements that were removed.

5.21 FlushResources

New in JDF 1.2

The [FlushResources](#) message is used to remove temporary resources from a device. [FlushResourceParams](#) specifies the resources to remove.

The [Command](#) allows a controller to request that a device actively flush its resources whereas the [Query](#) or [Signal](#) allows a device to message that it has flushed resources to a controller.

5.21.1 FlushResources Command

The [FlushResources Command](#) is used to remove temporary resources from a device. [FlushResourceParams](#) allows the specification of which resources to remove.

Table 5.35: [FlushResources](#) Command

OBJECT TYPE	ELEMENT NAME	DESCRIPTION
CommandTypeObj	FlushResourceParams ?	Defines the resources to be removed.
	QueueFilter ? Deprecated in JDF 1.5	Defines a filter for the returned Queue element in the FlushResources message.
ResponseTypeObj		This element is a placeholder for future use.

5.21.2 FlushResources Query

The [FlushResources Query](#) is used to query whether temporary resources have been removed by a device. [FlushResourceParams](#) allows the specification of which resources were removed.

Table 5.36: [FlushResources](#) Query

OBJECT TYPE	ELEMENT NAME	DESCRIPTION
QueryTypeObj	FlushResourceParams ?	Defines the resources to be removed.
	QueueFilter ? Deprecated in JDF 1.5	Defines a filter for the returned Queue element in the FlushResources message.
ResponseTypeObj		This element is a placeholder for future use.

5.21.2.1 FlushResourceParams

Table 5.37: FlushResourceParams Element

NAME	DATA TYPE	DESCRIPTION
FlushPolicy = "QueueEntry"	enumeration	Policy that defines how much of the QueueEntry resources is requested to be flushed. Allowed values are: Complete – Remove all temporary resources belonging to the selected QueueEntry including global resources that MAY be used by other QueueEntry elements. QueueEntry – The local resources belonging to the selected QueueEntry are completely removed and no longer available — the default. Intermediate – Remove any intermediate resources that belong to the QueueEntry (e.g., intermediate raster files in a combined RIP and Image-Setting Process), and retain the original input resources. A ResourcePull message is still possible after executing FlushResources with @FlushPolicy="Intermediate".
QueueFilter ?	element	Defines a QueueFilter that specifies the QueueEntry elements to which the resources to be removed belong. If not specified, all temporary resources on the device are completely flushed according to the value of @FlushPolicy.

5.22 ForceGang

New in JDF 1.3

The ForceGang message forces all QueueEntry[@Status="Waiting"] elements that belong to a gang to be executed, even though the device dependent queue entry collecting algorithm might not be completed. A QueueEntry belongs to a gang if QueueEntry/@GangName is included in the list of GangCmdFilter/@GangNames.

Table 5.38: Contents of the ForceGang Command Message

OBJECT TYPE	ELEMENT NAME	DESCRIPTION
CommandTypeObj	GangCmdFilter	Defines the gang(s) to be forcibly executed.
ResponseTypeObj	—	

5.22.1

5.22.2 GangCmdFilter

Table 5.39: GangCmdFilter Element

OBJECT TYPE	ELEMENT NAME	DESCRIPTION
GangNames ?	NMTOKENS	A list of @GangName values of the gang(s) to be selected.
Policy ?New in JDF 1.6	enumeration	The policy with which the elements in the gang SHALL be processed. Allowed values are: All - All elements in a given gang SHALL be processed. Optimized - As many elements in a given gang as can be processed without unnecessary waste SHOULD be processed. The algorithm for selecting the respective elements is implementation dependent and SHOULD take priority and scheduling data into account.

5.23 GangStatus

New in JDF 1.3

GangStatus returns a description of the gang(s). Details are specified in the **GangInfo** element.

Table 5.40: GangStatus Message

OBJECT TYPE	ELEMENT NAME	DESCRIPTION
QueryTypeObj	GangQuFilter ?	Defines a filter for the gang(s) that are queried. If GangQuFilter is not supplied, all gangs are queried.
ResponseTypeObj	GangInfo *	Describes the status of the gang(s).

5.23.1 GangQuFilter

Table 5.41: GangQuFilter Element

NAME	DATA TYPE	DESCRIPTION
GangNames ?	NMTOKENS	@ GangName of the gang(s) being queried.

5.23.2 GangInfo

Details of the gang are specified in **GangInfo** elements.

Table 5.42: GangInfo Element

NAME	DATA TYPE	DESCRIPTION
Amount ? New in JDF 1.6	double	Quantity of QueueEntry items that are currently waiting to be executed. If the device specifies amount in a unit other than countable objects, such as m ² , @ Amount SHALL be specified in the units of the device.
GangName	NMTOKEN	Name of the gang.

5.24 HoldQueue

The queue is held. No entries will start execution. Note that the status of a held entry prior to **HoldQueue** is retained so that held jobs remain held after a **ResumeQueue**. New entries can still be submitted to a held queue. **HoldQueue** only affects jobs that have not commenced processing. Queue entries that are already running SHALL be suspended individually using the **SuspendQueueEntry** command message.

Table 5.43: HoldQueue Message

OBJECT TYPE	ELEMENT NAME	DESCRIPTION
CommandTypeObj Modified in JDF 1.5	QueueFilter ? New in JDF 1.2 Deprecated in JDF 1.5	Defines a filter for the returned Queue element in the HoldQueue message.
ResponseTypeObj Modified in JDF 1.5	Queue Deprecated in JDF 1.5	Describes the state of the queue after the command has been executed.

5.25 HoldQueueEntry

The entry specified by **HoldQueueEntryParams/QueueFilter** remains in the queue but is not executed. If its @**Status** is "Waiting", its @**Status** is set to "Held". The **HoldQueueEntry** command message has no effect on jobs with a @**Status** other than "Waiting". If **QueueEntry/@GangPolicy** is other than "NoGang", a held **QueueEntry** retains its respective gang data but

does not influence execution of other jobs that are in the gang. For details, see ▶ Table 5.20 Status Transitions for QueueEntry Handling Messages.

Table 5.44: HoldQueueEntry Message

OBJECT TYPE	ELEMENT NAME	DESCRIPTION
CommandTypeObj Modified in JDF 1.5	HoldQueueEntryParams ? New in JDF 1.5	
	QueueEntryDef Deprecated in JDF 1.5	Defines the queue entry.
	QueueFilter ? New in JDF 1.2 Deprecated in JDF 1.5	Defines a filter for the returned Queue elements in the HoldQueueEntry message.
ResponseTypeObj Modified in JDF 1.5	Queue Deprecated in JDF 1.5	Describes the state of the queue after the command has been executed.

5.25.1 HoldQueueEntryParams

New in JDF 1.5

Table 5.45: HoldQueueEntryParams Element

NAME	DATA TYPE	DESCRIPTION
QueueFilter ?	element	This QueueFilter selects the QueueEntry elements to apply this message to.

5.26 KnownControllers

Deprecated in JDF 1.5

Starting with **JDF** 1.5, use **KnownDevices**.

5.27 KnownDevices

The **KnownDevices** query message requests information about the devices that are controlled by a controller. If a high level controller controls lower level controllers, it SHOULD also list the devices that are controlled by these. The response is a **DeviceList** which is a list of **DeviceInfo** elements controlled by the controller that receives the query, as demonstrated in ▶ Example 5.15:KnownDevices Response.

Table 5.46: KnownDevices Message

OBJECT TYPE	ELEMENT NAME	DESCRIPTION
QueryTypeObj	DeviceFilter ?	Refines the list of devices queried. Only devices that match the DeviceFilter are listed. The default SHALL return a list of all known devices.
ResponseTypeObj Modified in JDF 1.1A	DeviceList ?	The list of known devices. Modification note: Before JDF 1.1A this was “ Device* ”. It was changed due to inconsistencies of the inheritance model in the JDF schema.

Example 5.15: KnownDevices Response

```
<Response ID="M1" Type="KnownDevices" refID="Q1" xsi:type="ResponseKnownDevices">
  <DeviceList>
    <DeviceInfo DeviceStatus="Unknown">
      <Device DeviceID="Joe SpeedMaster" DeviceType="Heidelberg SM102/6 rev. 47"/>
    </DeviceInfo>
  </DeviceList>
</Response>
```

5.27.1 DeviceFilter

The **DeviceFilter** element refines the list of devices that are requested to be returned. Only devices that match all parameters of one of the **Device** resources specified in the **DeviceFilter** element are included.

Table 5.47: DeviceFilter Element

NAME	DATA TYPE	DESCRIPTION
DeviceDetails = "None" New in JDF 1.1	enumeration	@DeviceDetails refines the level of provided information about the device. Allowed values are: Brief – Provide all available device information except for Device elements. Capability – Provide Device/DeviceCap subelements which represent details of the capabilities of the device. Details – Provide maximum available device information excluding device capability descriptions. Includes Device elements which represent details of the device. Full – Provide maximum available device information including Device capability descriptions. Includes Device elements which represent details of the device. Modules – ModuleStatus elements are to be provided without module specific status details and without module specific employee information. NamedFeature – Provide maximum available device information including limited device capability descriptions. Includes Device elements which represent details of the device and Device/DeviceCap/FeaturePool subelements which represent named features of the device. None – Provide only DeviceInfo/@DeviceID and DeviceInfo/@DeviceStatus .
Localization ? New in JDF 1.2	languages or "all"	If present, @Localization defines the language code(s) specifying the localization(s) to be returned for each device (see the DeviceCap subelement description for details of what entries are localized). If "all" is specified, then all localizations for the device are returned. If not specified, no localizations are returned.
Device *	element	Only devices that match the attribute values specified in one of these Device resources are included. Devices match the criteria if the attribute values specified here in the Device resource match the equivalent attribute values of the known devices. Unspecified attributes always match. If Device is not specified, all known Device resources are returned. As this is a filter, only information that can be used to identify a device SHALL be specified. This precludes use of DeviceCap and IconList in this Device . The data type of Device is ResourceElement . See ▶ Section 3.10.1 ResourceElement – Subelement of a Resource.

5.27.2 DeviceList

New in JDF 1.1A

The **DeviceList** element contains a list of information about devices that are returned.

Table 5.48: DeviceList Element

NAME	DATA TYPE	DESCRIPTION
DeviceInfo *	element	List of information about known devices as requested by the DeviceFilter element. For details of the DeviceInfo element, see ▶ Table 5.103 DeviceInfo Element in the message description ▶ Section 5.55 Status.

5.28 KnownJDFServices

Deprecated in JDF 1.2

In JDF 1.2 and beyond, *KnownJDFServices* has been replaced with *KnownDevices* and *@DeviceDetails="Capabilities"*.

5.29 KnownMessages

The *KnownMessages* query message returns a list of all message types that are supported by the controller.

Table 5.49: *KnownMessages Message*

OBJECT TYPE	ELEMENT NAME	DESCRIPTION
<i>QueryTypeObj</i>	<i>KnownMsgQuParams</i> ?	Refines the query for known messages. If not specified, list all supported message types.
<i>ResponseTypeObj</i>	<i>MessageService</i> *	Specifies the supported messages. Multiple <i>MessageService</i> elements MAY be specified for a message with a given <i>JMF/@Type</i> .

5.29.1 KnownMsgQuParams

The flags of the *KnownMsgQuParams* element specify the message families to include in the response list. Multiple flags are allowed.

Table 5.50: *KnownMsgQuParams Element*

NAME	DATA TYPE	DESCRIPTION
<i>ChannelMode</i> ? New in JDF 1.4	enumerations	Limits the list based on supported channel modes for the message. Allowed value is from: ▶ <i>ChannelMode</i> Note: See ▶ Table 5.5 Signal Message Element.
<i>Exact</i> = "false" New in JDF 1.1	boolean	Requests an exact description of the known messages. If "true", the response also contains the requested <i>DevCaps</i> of the messages.
<i>ListCommands</i> = "true"	boolean	Lists all supported <i>Command</i> types.
<i>ListQueries</i> = "true"	boolean	Lists all supported <i>Query</i> types.
<i>ListRegistrations</i> = "true" New in JDF 1.3	boolean	Lists all supported <i>Registration</i> message types.
<i>ListSignals</i> = "true"	boolean	Lists all supported <i>Signal</i> types.
<i>Persistent</i> = "false"	boolean	If "true", only lists messages that can use persistent channels. If "false", ignores the ability to use persistent channels.

5.29.2 MessageService

The response is a list of *MessageService* elements, one for each supported message type. The flags of the *MessageService* response message element are set in each *MessageService* entry. They define the supported usage of the message by the controller. Note that no *@Response* attribute is included in the list, since the capability to process one of the other message families implies the capability to generate an appropriate *Response* message. Multiple flags are allowed.

Table 5.51: *MessageService Element (Sheet 1 of 2)*

NAME	DATA TYPE	DESCRIPTION
<i>Acknowledge</i> = "false" New in JDF 1.1	boolean	If "true", the device supports asynchronous <i>Acknowledge</i> answers to this message.
<i>ChannelMode</i> ? New in JDF 1.4	enumerations	Specifies the supported channel modes for the message. Allowed value is from: ▶ <i>ChannelMode</i> Note: See ▶ Table 5.5 Signal Message Element.
<i>Command</i> = "false"	boolean	If "true", the message is supported as a <i>Command</i> .

Table 5.51: MessageService Element (Sheet 2 of 2)

NAME	DATA TYPE	DESCRIPTION
<i>GenericAttributes</i> ? New in JDF 1.3	NMTOKENS	List of generic attributes that are supported and unrestricted by the device implementation. Descriptions of attributes that appear in <i>State</i> elements (see the following ▶ Section 10.2.7 State) overwrite the description in <i>@GenericAttributes</i> , which SHALL NOT be specified if <i>KnownMsgQuParams/@Exact = "false"</i> .
<i>JMFRole</i> ? New in JDF 1.3	enumeration	The role of the device that responds with the <i>MessageService</i> . Allowed values are: <i>Receiver</i> – The device that responds to <i>KnownMessages</i> receives and responds to the message specified in <i>@Type</i> . This <i>MessageService</i> specifies query messages, signal messages command messages and registration messages that the device understands. <i>Sender</i> – The device that responds to <i>KnownMessages</i> is the originator of the message specified in <i>@Type</i> . This <i>MessageService</i> specifies <i>Response</i> elements and <i>Acknowledge</i> elements that the device understands as a <i>Response</i> to the messages that it has sent.
<i>Persistent = "false"</i>	boolean	If "true" the message is supported as a persistent channel.
<i>Query = "false"</i>	boolean	If "true" the message is supported as a <i>Query</i> .
<i>Registration = "false"</i> New in JDF 1.3	boolean	If "true" the message is supported as a <i>Registration</i> message.
<i>Signal = "false"</i>	boolean	If "true" the message is supported as a <i>Signal</i> .
<i>Type</i>	NMTOKEN	Type of the supported message. Extension types are specified by stating the namespace prefix in <i>@Type</i> Values include those from: ▶ Table 5.14 List of JMF Messages.
<i>URLSchemes</i> ? New in JDF 1.3	NMTOKENS	List of schemes supported for the message defined by this <i>MessageService</i> . Allowed values include: <i>file</i> – The file scheme according to ▶ [RFC1738] and ▶ [RFC3986]. <i>http</i> – HTTP (Hypertext Transport Protocol) <i>https</i> – HTTPS (Hypertext Transport Protocol – Secure)
<i>ActionPool</i> ? New in JDF 1.3	element	Container for zero or more <i>Action</i> elements for use as constraints. For details on <i>Action</i> elements, see ▶ Section 10.2.2 ActionPool. <i>ActionPool</i> SHALL NOT be specified if <i>KnownMsgQuParams/@Exact="false"</i> .
<i>DevCapPool</i> ? New in JDF 1.3	element	Pool of <i>DevCap</i> elements that can be referenced from multiple elements within the <i>DeviceCap</i> structure. <i>DevCapPool</i> SHALL NOT be specified if <i>KnownMsgQuParams/@Exact="false"</i> .
<i>DevCaps</i> * New in JDF 1.1	element	Specifies the restrictions of the parameter space of the supported messages. For details on using <i>DevCaps</i> , see ▶ Section 10.2.5 DevCaps. <i>DevCaps</i> SHALL NOT be specified if <i>KnownMsgQuParams/@Exact="false"</i> .
<i>ModulePool</i> ? New in JDF 1.3	element	Pool of <i>ModuleCap</i> elements that specify the availability of a given module. See ▶ Section 10.2.4.1 ModuleCap for details of <i>ModuleCap</i> . <i>ModulePool</i> SHALL NOT be specified if <i>KnownMsgQuParams/@Exact="false"</i> .
<i>State</i> * New in JDF 1.4	element	<i>State</i> elements that define the parameter space that is covered by the device. One <i>State</i> element SHALL be defined for each supported attribute of the JDF node that is not specified <i>@GenericAttributes</i> or implied by <i>@TypeExpression</i> or <i>@Types</i> .
<i>TestPool</i> ? New in JDF 1.3	element	Container for zero or more <i>Test</i> elements that are referenced from <i>ActionPool/Action</i> elements. <i>TestPool</i> SHALL NOT be specified if <i>KnownMsgQuParams/@Exact="false"</i> .

Example 5.16: KnownMessages Response

The following is an example of a response message to a *KnownMessages* query message.

```
<Response ID="M1" Type="KnownMessages" refID="Q1" xsi:type="ResponseKnownMessages">
  <MessageService JMFRole="Receiver" Query="true" Type="KnownMessages"/>
  <MessageService JMFRole="Receiver" Persistent="true" Query="true"
    Signal="true" Type="Status"/>
</Response>
```

5.30 KnownSubscriptions

New in JDF 1.4

The *KnownSubscriptions* message enables controllers to query devices for a list of active persistent channels.

Table 5.52: KnownSubscriptions Message

OBJECT TYPE	ELEMENT NAME	DESCRIPTION
<i>QueryTypeObj</i>	<i>SubscriptionFilter</i> ?	Refines the query for known messages. If not specified, list all supported message types.
<i>ResponseTypeObj</i>	<i>SubscriptionInfo</i> *	List of active persistent channels.

5.30.1 SubscriptionFilter

New in JDF 1.4

The *SubscriptionFilter* element is a filter to limit the list of *SubscriptionInfo* elements that are returned in the *KnownSubscriptions* response.

Table 5.53: SubscriptionFilter Element

NAME	DATA TYPE	DESCRIPTION
<i>ChannelID</i> ?	NMTOKEN	@ <i>ChannelID</i> of the persistent channel to be queried. If the channel has been created with a <i>Query</i> message, the @ <i>ChannelID</i> specifies the @ <i>ID</i> of the <i>Query</i> message (identical to the @ <i>refID</i> of the <i>Response</i> message)
<i>DeviceID</i> ?	NMTOKEN	Only subscriptions from devices or controllers with a matching @ <i>DeviceID</i> attribute are queried.
<i>Families</i> ?	enumerations	Only subscriptions with the family (<i>Signal</i> or <i>Command</i>) listed are queried
<i>JobID</i> ? Deprecated in JDF 1.5	string	@ <i>JobID</i> of the JDF node that messages are subscribed for. If not specified, subscriptions are returned for all @ <i>JobID</i> values. Deprecation note: Job specific subscriptions are discouraged.
<i>JobPartID</i> ? Deprecated in JDF 1.5	string	@ <i>JobPartID</i> of the JDF node that messages are subscribed for. If not specified, subscriptions are returned for all @ <i>JobPartID</i> values. Deprecation note: Job specific subscriptions are discouraged.
<i>MessageTypes</i> ?	NMTOKENS	List of <i>Message/@Type</i> values of the subscribed messages. If not specified, subscriptions are returned for all message types.
<i>QueueEntryID</i> ? Deprecated in JDF 1.5	string	@ <i>QueueEntryID</i> of the job whose subscriptions are queried. If @ <i>QueueEntryID</i> is specified, @ <i>JobID</i> , @ <i>JobPartID</i> and <i>Part</i> are ignored. If none of @ <i>JobID</i> , @ <i>JobPartID</i> , <i>Part</i> or @ <i>QueueEntryID</i> are specified, <i>KnownSubscriptions</i> applies to all persistent channels that were established. Deprecation note: Job specific subscriptions are discouraged.
<i>URL</i> ?	URL	URL of the receiving controller. This SHALL be identical to the @ <i>URL</i> that was used to create the persistent channel. If no @ <i>ChannelID</i> is specified, all persistent channels to this @ <i>URL</i> are queried.
<i>Part</i> * Deprecated in JDF 1.5	element	<i>Part</i> elements that describe the partition of the job whose subscriptions are queried. For details on node partitions, see ▶ Section 4.3.2 Partial processing of nodes with Partitioned resources. Deprecation note: Job specific subscriptions are discouraged.

5.31 ModifyNode

New in JDF 1.3

This **JMF** is used to modify either the `@Activation` or `@CommentURL` attributes of a **JDF** node and to add or modify **Comment** elements of a **JDF** node or a resource.

5.31.1 ModifyNode Command

The **ModifyNode Command** is sent by a controller to a device to modify the **JDF** node on the device.

Table 5.54: ModifyNode Command

OBJECT TYPE	ELEMENT NAME	DESCRIPTION
<i>CommandTypeObj</i>	<i>ModifyNodeCmdParams</i> ?	Defines the details of the ModifyNode message.
<i>ResponseTypeObj</i>	–	–

5.31.2 ModifyNode Signal

The **ModifyNode Signal** is sent by a device to a control to signal that the **JDF** node on the device has been modified.

Table 5.55: ModifyNode Signal

OBJECT TYPE	ELEMENT NAME	DESCRIPTION
<i>QueryTypeObj</i>	<i>ModifyNodeCmdParams</i> ?	Defines the details of the ModifyNode message.
<i>ResponseTypeObj</i>	–	–

5.31.2.1 ModifyNodeCmdParams

The **ModifyNodeCmdParams** specifies the details of the **JDF** node to be modified.

Table 5.56: ModifyNodeCmdParams Element

NAME	DATA TYPE	DESCRIPTION
<i>Activation</i> ?	enumeration	The new value for <code>@Activation</code> . Allowed value is from: ▶ Activation.
<i>CommentURL</i> ?	URL	The new value for <code>@CommentURL</code> . Note that <code>@CommentURL</code> is specified in ▶ Table 3.1 Any Element (generic content) and that the semantics are overridden by the definition in this table.
<i>JobID</i>	string	<code>@JobID</code> of the node to be modified. In case of adding a Comment to a Resource or Audit , this <code>@JobID</code> SHALL be an attribute of the node where the AuditPool or AuditPool resides.
<i>JobPartID</i>	string	<code>@JobPartID</code> of the node to be modified. In the case of adding a Comment to a Resource or Audit , this <code>@JobPartID</code> SHALL be an attribute of the node where the AuditPool or ResourcePool resides.
<i>NewComment</i> *	element	Details of modifications of Comment elements.

5.31.2.2 NewComment

Table 5.57: NewComment Element

NAME	DATA TYPE	DESCRIPTION
<i>Action</i>	enumeration	Allowed values are: Add – A new Comment is added. If @refID is specified, the comment is stored in the resource or Audit with @ID = @refID . Concat – Comment is concatenated to the Comment with Comment/@ID = @CommentID . Replace – Comment replaces the Comment with Comment/@ID = @CommentID . Remove – The comment with Comment/@ID = @CommentID is removed.
<i>CommentID ?</i>	NMTOKEN	@ID of the existing Comment . SHALL be specified if @Action="Concat" , "Replace" or "Remove" .
<i>refID ?</i>	NMTOKEN	@ID of the Resource or Audit where the Comment SHALL be added. The @refID SHALL NOT be set unless @Action="Add" .
<i>Comment ?</i>	element	The Comment to "Add", "Concat" or "Replace". Comment SHALL NOT be specified if @Action="Remove" . Note that Comment * is specified in ▶ Table 3.1 Any Element (generic content) and that the cardinality and semantics are overridden by the definition in this table.
<i>Part ?</i> New in JDF 1.4	element	Partition of the resource where the Comment SHALL be added. Part SHALL NOT be specified unless @refID references a resource and @Action="Add" .

5.32 NewJDF

New in JDF 1.2

The **NewJDF** message can be used to query and initiate the modification of **JDF** nodes by either a subordinate controller or a master controller. It is mainly used to synchronize **JDF/@JobID** and **JDF/@JobPartID** between an MIS and a device or controller. Either side MAY initiate synchronization. A query message or signal message informs a controller or MIS system that a **JDF** node has been created. A command initiates a modification.

5.32.1 NewJDF Query

The **NewJDF Query** message is sent to a device or controller in order to extract information about previously unknown **JDF** nodes. For instance, an MIS that has received a **JMF** with an unknown **@JobPartID** MAY query the **JMF** sender about details of the **JDF** with that **@JobPartID**. When used as a signal, the signaling device specifies that it has created a new **JDF** with the properties defined by **IDInfo**, for instance when a workflow controller has instantiated an abstract process group node with new subnodes. **NewJDF** is made selective by specifying a **NewJDFQuParams** element.

The query's response message returns a list of **IDInfo** elements that contains the queried information concerning the newly created nodes.

Table 5.58: NewJDF Query Message

OBJECT TYPE	ELEMENT NAME	DESCRIPTION
<i>QueryTypeObj</i>	<i>NewJDFQuParams</i>	Specifies the details of the nodes that information is requested about.
<i>ResponseTypeObj</i>	<i>IDInfo *</i>	Contains the information about the newly created nodes.

5.32.1.0.1 NewJDFQuParams

Table 5.59: NewJDFQuParams Element

NAME	DATA TYPE	DESCRIPTION
<i>JobID</i> ?	string	@ <i>JobID</i> of the JDF node that is being queried.
<i>JobPartID</i> ?	string	@ <i>JobPartID</i> of the JDF node that is being queried.
<i>QueueEntryID</i> ?	string	@ <i>QueueEntryID</i> of the job that is currently being executed. If @ <i>QueueEntryID</i> is specified, @ <i>JobID</i> and @ <i>JobPartID</i> are ignored.

5.32.2 NewJDF Command

The **NewJDF Command** message is sent to an MIS, device or controller to initiate creation of new **JDF** nodes by that device or controller. For instance, a workflow controller might have received content data and now requires a **JDF** job from an MIS to which work on the content can be booked. The **NewJDF Command** message does not imply any job submission or request for job submission. Job queue submission SHALL still be requested with a **RequestQueueEntry** message, and the MIS SHALL still subsequently submit the job to the requesting controller or device.

Table 5.60: NewJDF Command Message

OBJECT TYPE	ELEMENT NAME	DESCRIPTION
<i>CommandTypeObj</i>	<i>NewJDFCmdParams</i>	Specifies the details of the nodes that are to be created
<i>ResponseTypeObj</i>	<i>IDInfo</i> ?	Contains the information about the newly created node.

5.32.2.1 NewJDFCmdParams

Table 5.61: NewJDFCmdParams Element

NAME	DATA TYPE	DESCRIPTION
<i>JDFDetails</i> = "Brief"	string	Level of detail requested for the returned <i>IDInfo</i> elements. Values include: None – Do not return any <i>IDInfo</i> elements. Brief – Return <i>IDInfo</i> elements without embedded JDF or device. Full – Return <i>IDInfo</i> elements with embedded JDF and device.
<i>IDInfo</i>	element	Details of the new JDF node that SHALL be created.

5.32.2.2 IDInfo

Table 5.62: IDInfo Element (Sheet 1 of 2)

NAME	DATA TYPE	DESCRIPTION
<i>Category</i> ?	NMTOKEN	<i>JDF</i> / <i>@Category</i> of the JDF node. Values include those from: ▶ Node Categories.
<i>JDFURL</i> ? New in JDF 1.5	URL	URL to detailed JDF description. Provides a way of referencing a JDF element instead of embedding it at <i>IDInfo</i> / <i>JDF</i> . At most one of JDF and @ <i>JDFURL</i> SHALL be specified. Note: The referenced ▶ JDF MAY be an ancestor ▶ JDF Node of the newly created node. In this case the recipient SHALL search the returned ▶ JDF for the ▶ JDF Node with the correct @ <i>JobPartID</i> .
<i>JobID</i> ?	string	@ <i>JobID</i> of the JDF node.
<i>JobPartID</i> ?	string	@ <i>JobPartID</i> of the JDF node.
<i>ParentJobID</i> ?	string	@ <i>JobID</i> of the parent node of the JDF node. If not specified, it defaults to the value of @ <i>JobID</i> .
<i>ParentJobPartID</i> ?	string	Job Part ID of the parent node of the JDF node.

Table 5.62: IDInfo Element (Sheet 2 of 2)

NAME	DATA TYPE	DESCRIPTION
<i>ProjectID</i> ? New in JDF 1.5	string	Identification of the project context that the JDF described by this IDInfo belongs to. Enables usage of NewJDF in a web to print environment where @ProjectID represents the shopping cart.
<i>Type</i> ?	NMTOKEN	JDF/@Type of the JDF node. Values include: Combined ProcessGroup Product Values include those from: ▶ Chapter 6 Processes.
<i>Types</i> ?	NMTOKENS	JDF/@Types of the JDF node. Values include those from: ▶ Chapter 6 Processes.
<i>Device</i> ?	element	Description of the device that the JDF is targeted for. The data type of Device is ResourceElement. See ▶ Section 3.10.1 ResourceElement – Subelement of a Resource.
<i>JDF</i> ?	element	Detailed JDF description. Contains information that allows the receiver of the NewJDF message to properly respond. Note that the JDF is not implicitly submitted. At most one of JDF and @JDFURL SHALL be specified. Note: This may be an ancestor ▶ JDF Node of the newly created ▶ Node. In this case the recipient SHALL search the returned ▶ JDF for the ▶ JDF Node with the correct @JobPartID .

5.33 NodeInfo

New in JDF 1.2

Deprecated in JDF 1.3

The **NodeInfo** message has been replaced with the **Resource** message in **JDF** 1.3.

5.34 Notification

Notification messages are generally sent as **Signals**. **QueryNotification** is defined to allow subscriptions for **Notification** messages. **Notification** elements are also used to signal usual events due to any activities of a device, operator, etc. (e.g., scanning a bar code). Such a **Signal** always has a **@Type="Notification"**.

Table 5.63: Notification Signal

OBJECT TYPE	ELEMENT NAME	DESCRIPTION
<i>QueryTypeObj</i>	NotificationFilter ? New in JDF 1.4	Defines the types of Notification elements that should be returned.
<i>ResponseTypeObj</i>	Notification	Notification that describes the event. See ▶ Section 3.11.4.5 Notification.

5.34.1 NotificationFilter

Table 5.64: NotificationFilter Element (Sheet 1 of 2)

NAME	DATA TYPE	DESCRIPTION
<i>Classes</i> ?	enumerations	Defines the set of Notification/@Class types to be queried/subscribed for. If @Classes is not specified then all Notification classes are queried or subscribed to. Allowed values are from: ▶ Severity. Constraint note: If both @Classes and @Types contain lists of values, the NotificationFilter defines an OR of all combinations.
<i>DeviceID</i> ? Deprecated in JDF 1.3	string	ID of the device whose messages are queried/subscribed. MAY be specified for device selection if the controller controls more than one device. Deprecation note: Starting with JDF 1.3, use JMF/@DeviceID .

Table 5.64: NotificationFilter Element (Sheet 2 of 2)

NAME	DATA TYPE	DESCRIPTION
<i>JobID</i> ? Deprecated in JDF 1.5	string	JobID of the job whose messages are queried/subscribed. Deprecation note: Job specific subscriptions are discouraged.
<i>JobPartID</i> ? Deprecated in JDF 1.5	string	JobPartID of the job whose messages are queried/subscribed. Deprecation note: Job specific subscriptions are discouraged.
<i>MilestoneTypes</i> ?	NMTOKENS	Matching milestone types SHALL be returned and/or subscribed to. If <i>@MilestoneTypes</i> is not specified then all supported milestone values are queried or subscribed to. Values include those from: ▶ Milestones.
<i>QueueEntryID</i> ? New in JDF 1.2 Deprecated in JDF 1.5	string	<i>@QueueEntryID</i> of the job whose messages are queried/subscribed. If <i>@QueueEntryID</i> is specified, <i>@JobID</i> , <i>@JobPartID</i> and <i>Part</i> are ignored. If none of <i>@JobID</i> , <i>@JobPartID</i> , <i>Part</i> or <i>@QueueEntryID</i> are specified, <i>NotificationFilter</i> applies to all jobs. Deprecation note: Job specific subscriptions are discouraged.
<i>SignalTypes</i> = "Notification" New in JDF 1.2	NMTOKENS	<i>Signal/@Type</i> values of the subscribed messages. <i>@SignalTypes</i> SHOULD contain values as shown in <i>Message/@Type</i> , but are restricted to the values for <i>Signal</i> messages. Values include: <i>All</i> – Specifies that all signals, regardless of <i>@Type</i> are queried/subscribed.
<i>Types</i> ?	NMTOKENS	Matching notification types are returned/subscribed. If <i>@Types</i> is not specified then all supported type values are queried or subscribed to. Values include those from: ▶ Notification Details.
<i>Part</i> * New in JDF 1.2 Deprecated in JDF 1.5	element	<i>Part</i> elements that describe the partition of the job whose messages are queried/subscribed. For details on job partitions, see ▶ Section 4.3.2 Partial processing of nodes with Partitioned resources. Deprecation note: Job specific subscriptions are discouraged.

Example 5.17: Notification Signal

```
<Signal ID="S1" Type="Notification" xsi:type="SignalNotification">
  <Notification Class="Event" TimeStamp="2005-07-25T12:32:48+02:00" Type="Barcode">
    <Comment>Palette completed</Comment>
    <Barcode Code="99923AAA123"/>
  </Notification>
</Signal>
```

5.35 Occupation

Deprecated in JDF 1.5

The *Occupation* message has been deprecated in JDF 1.5.

Deprecation note: *Activity* elements provide the functionality that makes *Occupation* redundant.

5.36 OpenQueue

The queue is opened and new queue entries can be accepted by the queue. A held queue remains held. The *OpenQueue* command message is the opposite of a *CloseQueue* command message.

Table 5.65: OpenQueue Message (Sheet 1 of 2)

OBJECT TYPE	ELEMENT NAME	DESCRIPTION
<i>CommandTypeObj</i> Modified in JDF 1.5	<i>QueueFilter</i> ? New in JDF 1.2 Deprecated in JDF 1.5	Defines a filter for the returned <i>Queue</i> element in the <i>OpenQueue</i> message.

Table 5.65: OpenQueue Message (Sheet 2 of 2)

OBJECT TYPE	ELEMENT NAME	DESCRIPTION
ResponseTypeObj Modified in JDF 1.5	Queue Deprecated in JDF 1.5	Describes the state of the queue after the command has been executed.

5.37 PipeClose

The **PipeClose** message notifies the process at the other end of a dynamic pipe that the sender of this message needs no further resources or will produce no further resources through the pipe. The **PipeClose** command message response is equivalent to the **PipePull** and **PipePush** command message responses **PipePull** described below.

If **Resource/@PipeProtocol="JMFPush"** the producer SHALL terminate the pipe with a **PipeClose** message. If **Resource/@PipeProtocol="JMFPull"** the consumer SHALL terminate the pipe with a **PipeClose** message.

Table 5.66: PipeClose Message

OBJECT TYPE	ELEMENT NAME	DESCRIPTION
CommandTypeObj	PipeParams	Describes the pipe resource. The PipeParams element is described in ▶ Section 5.39 PipePull.
ResponseTypeObj Modified in JDF 1.5	JobPhase Deprecated in JDF 1.5	The status of the responding process. The JobPhase element is defined in ▶ Table 5.104 JobPhase Element.

5.38 PipePause

The **PipePause** message pauses execution of a process that is at the other end of a dynamic pipe.

PipePause MAY be emitted by either the consumer or the producer whenever a condition exists that requires a resynchronization.

If **Resource/@PipeProtocol="JMFPush"**, and the consumer sends a **PipePause**, the producer SHALL NOT send further **PipePush** messages until the consumer has reopened the pipe by sending a **PipePull** message.

If **Resource/@PipeProtocol="JMFPull"**, and the producer sends a **PipePause**, the consumer SHALL NOT send further **PipePull** messages until the producer has reopened the pipe by sending a **PipePush** message.

PipePause MAY be sent by the respective other end of the pipe even if the pipe is already paused. In this case the resynchronization requirements above still apply.

The **PipePause** command message response is equivalent to the **PipePull** command message response described above.

Table 5.67: PipePause Message

OBJECT TYPE	ELEMENT NAME	DESCRIPTION
CommandTypeObj	PipeParams	Describes the pipe resource. The PipeParams element is described in ▶ Section 5.39 PipePull.
ResponseTypeObj Modified in JDF 1.5	JobPhase Deprecated in JDF 1.5	The status of the responding process. The JobPhase element is defined in ▶ Table 5.104 JobPhase Element.

5.39 PipePull

The **PipePull** message requests resources that are described in a **JDF** dynamic pipe (see ▶ Section 3.8.7 Pipe Resources and ▶ Section 4.3.3 Overlapping processing Using Pipes). **PipePull** messages are the **JMF** equivalent of a dynamic input **ResourceLink**. Below, depicts the mode of operation of a **PipePull** message.

The **PipePull** command message response returns a **@ReturnCode** of 0 if the command has been accepted by the receiving controller. If not successful, **@ReturnCode** is one of the codes presented in ▶ Section C Return Values. The **Response** message MAY contain a **Notification** element. The **JobPhase** element (see ▶ Section 5.55 Status) returned SHOULD provide only the **@Status** attribute that describes the job status of the responding process after receiving the command.

If *Resource/@PipeProtocol="JMFPull"*, the consumer SHALL initiate the pipe with a *PipePull* command message.

Table 5.68: PipePull Message

OBJECT TYPE	ELEMENT NAME	DESCRIPTION
<i>CommandTypeObj</i>	<i>PipeParams</i>	Describes the requested pipe resource.
<i>ResponseTypeObj</i> Modified in JDF 1.5	<i>JobPhase</i> Deprecated in JDF 1.5	The status of the responding process. The <i>JobPhase</i> element is defined in ▶ Table 5.104 JobPhase Element.

Figure 5-7: Mechanism of a PipePull message

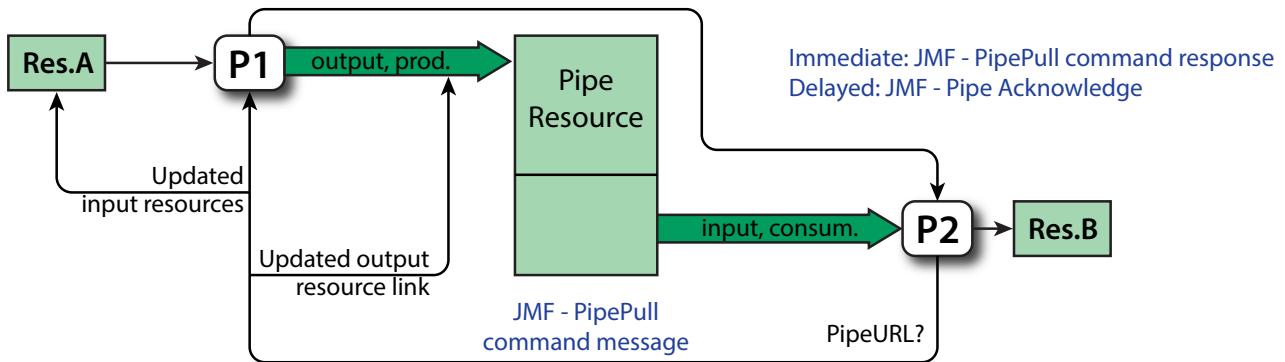

5.40 PipePush

The *PipePush* message notifies the availability of pipe resources that are described in a **JDF** dynamic pipe (see ▶ Section 3.8.7 Pipe Resources and ▶ Section 4.3.3 Overlapping processing Using Pipes). *PipePush* messages are the **JMF** equivalent of a dynamic output *ResourceLink*. The ▶ Figure 5-8: Mechanism of a PipePush message depicts the mode of operation of a *PipePush* message. The *PipePush* command message response is equivalent to the *PipePull* command message response described above.

If *Resource/@PipeProtocol="JMFPush"*, the producer SHALL initiate the pipe with a *PipePush* message.

Table 5.69: PipePush Message

OBJECT TYPE	ELEMENT NAME	DESCRIPTION
<i>CommandTypeObj</i>	<i>PipeParams</i>	Describes the produced pipe resource. The <i>PipeParams</i> element is described in ▶ Section 5.39 PipePull.
<i>ResponseTypeObj</i> Modified in JDF 1.5	<i>JobPhase</i> Deprecated in JDF 1.5	The status of the responding process. The <i>JobPhase</i> element is defined in ▶ Table 5.104 JobPhase Element.

Figure 5-8: Mechanism of a PipePush message

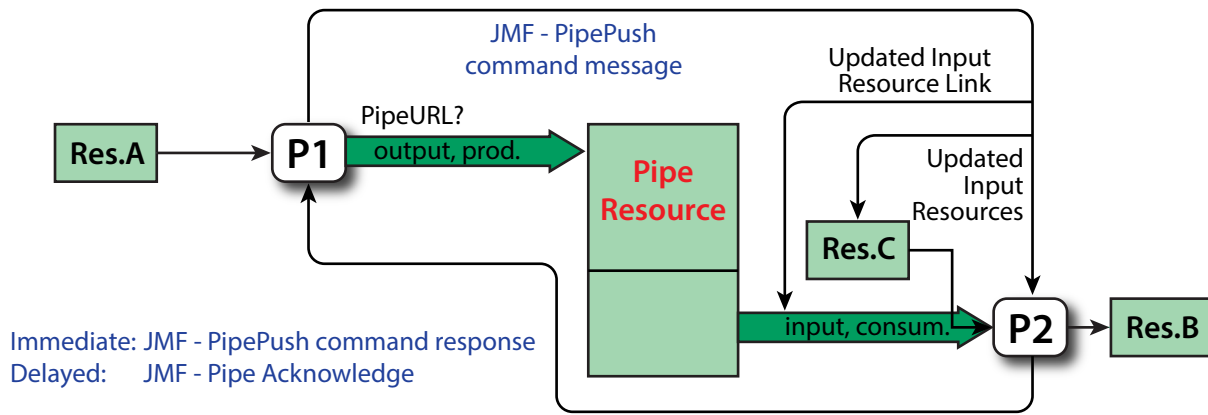

5.41 QueueStatus

QueueStatus returns a description of the current state of a queue.

Table 5.70: QueueStatus Message

OBJECT TYPE	ELEMENT NAME	DESCRIPTION
QueryTypeObj Modified in JDF 1.2	QueueFilter ? New in JDF 1.2	Defines a filter for the QueueStatus message.
ResponseTypeObj	Queue	Describes the status of the queue.

For the definition of the **Queue** element, see ▶ Section 5.14 Elements for Queues.

5.42 RemoveQueueEntry

This command causes the entries specified by **RemoveQueueEntryParams/QueueFilter** to be removed from the queue. It does not affect **QueueEntry** [**@Status="Running"** or **@Status="Suspended"**]. Use **AbortQueueEntry** to stop a running or suspended job and then remove it with **RemoveQueueEntry**. For details, see ▶ Table 5.20 Status Transitions for QueueEntry Handling Messages.

Table 5.71: RemoveQueueEntry Message

OBJECT TYPE	ELEMENT NAME	DESCRIPTION
CommandTypeObj Modified in JDF 1.2 Modified in JDF 1.5	QueueEntryDef Deprecated in JDF 1.5	Defines the queue entry.
	QueueFilter ? New in JDF 1.2 Deprecated in JDF 1.5	Defines a filter for the returned Queue elements in the RemoveQueueEntry message.
	RemoveQueueEntryParams ? New in JDF 1.5	
ResponseTypeObj Modified in JDF 1.5	Queue Deprecated in JDF 1.5	Describes the state of the queue after the command has been executed.

5.42.1 RemoveQueueEntryParams

New in JDF 1.5

Table 5.72: RemoveQueueEntryParams Element

NAME	DATA TYPE	DESCRIPTION
QueueFilter ?	element	This QueueFilter selects the QueueEntry elements to apply the RemoveQueueEntry message to.

5.43 RepeatMessages

Deprecated in JDF 1.5

The [RepeatMessages](#) message has been deprecated in JDF 1.5. [RepeatMessages](#) was designed to query for missed messages if signals were required to be complete. This functionality SHOULD preferably be implemented using reliable channels (i.e., by specifying [Subscription/@Channelmode="Reliable"](#). See ▶ Section 5.3.3 Reliable Signaling.

5.44 RequestForAuthentication

New in JDF 1.4

The [RequestForAuthentication](#) message can be used as a command to exchange certificates or as a query to obtain the authentication status of previously exchanged certificates. Acknowledge messages SHALL NOT be used to respond to a [RequestForAuthentication Command](#) or [RequestForAuthentication Query](#). In other words, the response element SHALL NOT specify [@Acknowledged="true"](#). If it is not possible to confirm authentication before the HTTP channel times out, the [@ReturnCode](#) SHALL be "304", which means "Authentication pending".

5.44.1 RequestForAuthentication Command

New in JDF 1.4

The [RequestForAuthentication Command](#) command is used to request authentication and trust of a certificate that is provided in the [RequestForAuthentication Command](#). The sender of the command is identified by the [@SenderID](#) attribute in the **JMF** element that contains the [RequestForAuthentication Command](#). The sender MAY be authenticated as both a client and as a server, and a separate certificate SHALL be provided by the sender for each role that the sender wishes to use. If a [RequestForAuthentication Command](#) is received over a secure channel, and a previous [RequestForAuthentication Command](#) has already been received, the previous [RequestForAuthentication Command](#) SHOULD be ignored, and any certificates associated with the prior command SHOULD be considered untrusted. This allows for a party that is currently trusted to update its certificate as needed (such as when the previous certificate is about to expire).

Once authentication has been established between two parties, any [RequestForAuthentication Command](#) that is sent over a non-secure channel SHALL result in error 305, which is "Authentication already established". Other [@Reason](#) values MAY be supported over secure channels.

Table 5.73: RequestForAuthentication Command Message

OBJECT TYPE	ELEMENT NAME	DESCRIPTION
CommandTypeObj	AuthenticationCmdParams	Details of the certificate of the sender.
ResponseTypeObj	AuthenticationResp ?	@ReturnCode="0" indicates "I trust you". The initial response to a RequestForAuthentication Command SHALL include a fully specified AuthenticationResp element.

5.44.1.1 AuthenticationCmdParams

Table 5.74: AuthenticationCmdParams Element (Sheet 1 of 2)

NAME	DATA TYPE	DESCRIPTION
AuthenticationType	enumeration	Allowed values are: AsClient – Sender of the message wishes to be authenticated as a client that initiates HTTP requests. Command includes the sender's client certificate, the response will include the responders server certificate. AsServer – Sender of message wishes to be authenticated as a server that responds to HTTP requests. Command includes the sender's server certificate, the response will include the responders client certificate.

Table 5.74: AuthenticationCmdParams Element (Sheet 2 of 2)

NAME	DATA TYPE	DESCRIPTION
Reason	enumeration	Used to indicate the reason for sending this message. Allowed values are: InitiateConnection – the client wishes to exchange certificates with the server. ClientCertificateExpired – the previously-sent client certificate has expired. ServerCertificateExpired – the previously-received server certificate has expired. ClientHostnameMismatch – the client certificate's Common Name couldn't be resolved to match the IP address or domain name from which the request came. ServerHostnameMismatch – the server certificate's Common Name couldn't be resolved to match the IP address or domain name from which the response came. ClientCertificateRevoked – the previously-sent client certificate has been revoked. ServerCertificateRevoked – the previously-received server certificate has been revoked. Other – some other reason. Use @ReasonDetails for further explanation.
ReasonDetails ?	string	Further details on the reason for this message.
SecureURL ?	URL	URL of the port of the command sender that will accept JMF messages via the HTTPS protocol. This attribute SHALL be specified when the sender of the RequestForAuthentication Command has specified AuthenticationCmdParams/@AuthenticationType="AsServer" .
Certificate ?	element	The requester's certificate. If @AuthenticationType="AsClient" , this certificate SHALL be the requester's client certificate. If @AuthenticationType="AsServer" , this certificate SHALL be the requester's server certificate.

5.44.1.2 Certificate

Table 5.75: Certificate Element

NAME	DATA TYPE	DESCRIPTION
	text	The certificate in PEM MD5 format. Implementation Note: There SHALL NOT be any whitespace between the end of the tag and the start of the certificate, or between the end of the certificate and the start of the end tag. See example below. Note: The certificate should only include the public key.

5.44.1.3 AuthenticationResp

Table 5.76: AuthenticationResp Element

NAME	DATA TYPE	DESCRIPTION
SecureURL ?	URL	URL of the port of the command recipient that will accept JMF messages via the HTTPS protocol. This attribute SHALL be specified when the sender of the RequestForAuthentication Command has specified AuthenticationCmdParams/@AuthenticationType="AsClient" .
Certificate ?	element	The command recipient's certificate. If AuthenticationCmdParams/@AuthenticationType="AsClient" , this certificate SHALL be the command recipient's server certificate. If AuthenticationCmdParams/@AuthenticationType="AsServer" , this certificate SHALL be the command recipient's client certificate. When responding to a RequestForAuthentication Command over a non-secure channel with Reason="InitiateConnection" , this element SHALL be specified. When responding to a RequestForAuthentication Query , the Certificate element SHALL NOT be specified. See AuthenticationCmdParams/Certificate .

5.44.2 RequestForAuthentication Query

New in JDF 1.4

The **RequestForAuthentication Query** is used to determine the authentication status of a certificate that was provided in an earlier **RequestForAuthentication Command** or the response to the command. The sender of the query is identified by the **@SenderId** attribute in the **JMF** element that contains the **RequestForAuthentication Query**. The sender MAY be authenticated as both a client and as a server, and a separate certificate SHALL be provided by the sender for each role that the sender wishes to use.

If a **RequestForAuthentication Query** is received, and no previous **RequestForAuthentication Command** has been received, the response SHALL specify a **@ReturnCode** of 306, which is "No authentication request in process". .

Table 5.77: RequestForAuthentication Query Message

OBJECT TYPE	ELEMENT NAME	DESCRIPTION
<i>QueryTypeObj</i>	<i>AuthenticationQuParams</i>	Specifies the type of authentication being queried.
<i>ResponseTypeObj</i>	<i>AuthenticationResp ?</i>	@ReturnCode="0" indicates "I trust you".

5.44.2.1 AuthenticationQuParams

Table 5.78: AuthenticationQuParams Element

NAME	DATA TYPE	DESCRIPTION
<i>AuthenticationType</i>	enumeration	Allowed values are: AsClient – Sender of the message wishes to check the authentication status of the client certificate associated with it. AsServer – Sender of message wishes to check the authentication status of the server certificate associated with it..

Example 5.18: RequestForAuthentication Command

```
<Command ID="M001" Type="RequestForAuthentication" xsi:type="CommandRequestForAuthentication">
  <AuthenticationCmdParams AuthenticationType="AsClient" Reason="InitiateConnection">
    <Certificate>=====BEGIN CERTIFICATE=====
MIIC3jCCApwCBEIWy6YwCwYHKoZiZjgEAwUAMFUxCzAJBgNVBAYTAkNIMQ8wDQYDVQQHEwZadXJp
Y2gxDTALBgNVBAoTBENJUDQxDzANBgNVBAcTBkpNRiBXRzEVMBMGAlUEAxMMd3d3LmNpcDQub3Jn
MB4XDTA1MDIxODIxNTIzOFoXDTA1MDUyOTIxNTIzOFowVTElMAkGA1UEBhMCQ0gxZzANBgNVBACt
Blplcm1jaDENMAsGAlUEChMEQ0lQNDEPMA0GA1UECzMGSk1GIFdHMRUwEwYDVQQDEwx3d3cuY2lw
NC5vcmcwggG3MIIBLAYHkoZiZjgEATCCAR8CgYEA/X9TgR11Ei1S30qcLuzk5/Yrt1I870QAwx4/
gLZRJmlFXUAiUftZPY1Y+r/F9bow9subVWzXgTuAHTRv8mZgt2uZUKWkn5/oBHsQIsJPu6nX/rfG
G/g7V+fGqKYVDwT7g/bTxR7DAjVUE1oWkTL2dfOuK2HXKu/yIgmZndFIAccCFQCXYFCPFsMLzLKS
uYKi64QL8Fgc9QKBgQD34aCF1ps93su8q1w2uFe5eZSvu/o66oL5V0wLPQeCZ1FZV4661F1P5nEH
EIGAtEkWcSPoTCgWE7fPCTKMyKbhPBZ6i1R8jSjgo64eK7OmdZFuo38L+iE1YvH7YnoBJDvMpPG+
qFGQiaid3+Fa5Z8GkotmXoB7VSVkAUw7/s9JKgOBhAACgYARHi/BVnf3OG0JIIdzWraVrx1wg9RM
do+tYRjY4bXue7LRDCvVaSX1Ddy9kTyeTTntwUrJOyx/8qEi/WmraGXhK8wGSrte/q3S/A16DwEB
CiyehMh1Crd4QiAhp5Wtr4KIMIBjq2Xn8+0MnnT1qDnmesNaSwdZ/01E0azSPTy5XnDALBgcqhkJ0
OAQDBQADLwAwLAIUFZHoJjvsO3+UYMBzk6yDzhdejzMCfHC0WbkDwfImQCa+dTebXZ1e1G1Q
=====END CERTIFICATE=====</Certificate>
  </AuthenticationCmdParams>
</Command>
```

Example 5.19: RequestForAuthentication Response

The form of response that would most likely follow the above command appears below:

```
<Response ID="M101" ReturnCode="304" Type="RequestForAuthentication"
  refID="M001" xsi:type="ResponseRequestForAuthentication">
  <AuthenticationResp SecureURL="https://printserver.mycompany.com/A3Printer">
    <Certificate>=====BEGIN CERTIFICATE=====
uYKi64QL8Fgc9QKBgQD34aCF1ps93su8q1w2uFe5eZsvu/o66oL5V0wLPQeCZ1FZV4661F1P5nEH
EIGAtEkWcSPoTCgWE7fPCTKMyKbhPBZ6i1R8jSjgo64eK7OmdZFuo38L+iE1YvH7YnoBJDvMpPG+
qFGQiaid3+Fa5Z8GkotmXoB7VSVkAUw7/s9JKgOBhAACgYArHi/BVnf3OG0JIIdzWraVrx1wg9RM
do+tYRjY4bXue7LRDCvVaSX1Ddy9kTyeTTntwUrJOyx/8qEi/WmraGXhK8wGSrte/q3S/Al6DwEB
CiyehMh1Crd4QiAhp5WtR4KIMIBjQ2Xn8+0MnnT1qDnmesNaSwdZ/01E0azSPTy5XnDALBgcqhkJ0
OAQDBQADLwAwLAIUFZHoJjvsO3+UYMBzk6yDzhdzjZMCFHC0WbkDwfImQCa+dTebXZ1e1G1Q
MIIC3jCCApwCBEIwY6YwCwYHkoZiZjgEAWAMFUxCzAJBgNVBAYTAKNIMQ8wDQYDVQQHEwZadXJp
Y2gxDTALBgNVBAoTBENJUDQxDzANBgNVBAStBkpNRiBXRzEVMBMGA1UEAxMMd3d3LmNpcDQub3Jn
MB4XDTA1MDIxODIxNTIzOFoXDTA1MDUyOTIxNTIzOFowVTElMAkGA1UEBhMCQ0gxZDzANBgNVBAcT
Blplcm1jaDENMASGALUEChMEQ0lQNDEPMA0GA1UECxmGsk1GIFdHMRUwEwYDVQQDEwz3d3cuY21w
NC5vcmcwggG3MIIBLAYHkoZiZjgEATCCAR8CgYEA/X9Tgr11EilS30qcLuzk5/YRt1I870QAwX4/
gLZRJm1FXUAIuftZPY1Y+r/F9bow9subVWzXgTuAHTrv8mZgt2uZUKWkn5/oBHsQIsJPu6nX/rfG
G/g7V+fGqKYVDwT7g/bTxr7DAjVUE1oWkTL2dfOuK2HXKu/yIgmZndFIAccCFQCXYFCPFSMLzLKS
=====END CERTIFICATE=====</Certificate>
  </AuthenticationResp>
</Response>
```

Example 5.20: Follow up RequestForAuthentication Query

Next, the original command sender would send a follow up [RequestForAuthentication Query](#):

```
<Query ID="M004" Type="RequestForAuthentication" xsi:type="QueryRequestForAuthentication">
  <AuthenticationQuParams AuthenticationType="AsClient"/>
</Query>
```

Example 5.21: RequestForAuthentication Response from Follow Up Query

If authentication has been confirmed, the following response would be sent to the [RequestForAuthentication Query](#):

```
<Response ID="M102" ReturnCode="0" Type="RequestForAuthentication"
  refID="M004" xsi:type="ResponseRequestForAuthentication"/>
```

5.45 RequestQueueEntry

New in JDF 1.2

This command requests a new queue entry from a potential submitting agent. The actual submission is still handled by the standard queue entry handling parameters.

Note: This command is emitted from the device that is represented by the queue to a controller or device and not to the queue, as is the case with most other queue handling commands.

Whereas **JDF** generally assumes a "Push" workflow, where a controller or MIS assigns a task to a given device, [RequestQueueEntry](#) allows a "Pull" workflow to be implemented, where a device with free processing capabilities dynamically requests a new task.

Table 5.79: RequestQueueEntry Message

OBJECT TYPE	ELEMENT NAME	DESCRIPTION
CommandTypeObj	RequestQueueEntryParams	Defines the specifics for the requested job.
ResponseTypeObj	—	The response to this message contains no ResponseTypeObj , only an empty response element that specifies the @ReturnCode . Any job submission is handled using hot folders or the standard SubmitQueueEntry message.

5.45.1 RequestQueueEntryParams

Table 5.80: RequestQueueEntryParams Element

NAME	DATA TYPE	DESCRIPTION
<i>Activation</i> ? New in JDF 1.5	enumeration	Specifies the activation of the requested <i>QueueEntry</i> . Allowed value is from: ▶ Activation.
<i>JobID</i> ?	string	@ <i>JobID</i> of the requested <i>QueueEntry</i> .
<i>JobPartID</i> ?	string	@ <i>JobPartID</i> of the requested <i>QueueEntry</i> .
<i>QueueURL</i>	URL	URL of the <i>Queue</i> controller that is requesting the <i>QueueEntry</i> and will accept <i>Queue</i> manipulation messages. If URL specifies a file, this is the hot folder for JDF submission.
<i>SubmitPolicy</i> ? New in JDF 1.3	enumeration	Defines the requested policy for submitting the node. If not specified, the submission policy is dependent on the controller implementation. @ <i>SubmitPolicy</i> allows a device to request a node that would otherwise not be submitted by the controller due to missing resources. Allowed values are: <i>Standard</i> – All linked resources SHALL have a <i>Resource@Status</i> as defined by <i>ResourceLink/@MinStatus</i> . <i>Late</i> – All linked resources SHALL have a <i>Resource@Status</i> as defined by <i>ResourceLink/@MinLateStatus</i> . <i>Force</i> – The node SHALL be submitted regardless of the values of linked <i>Resource@Status</i> .
<i>Part</i> *	element	Partition parts of the requested <i>QueueEntry</i> .
<i>Queue</i> ?	element	Representation of the current status of the device's <i>Queue</i> .

5.46 Resource

The *Resource* message can be a *Command* message or a *Query* message to modify or to query JDF resources. In both cases (query and command), it is possible to address either global device resources, such as device settings or job-specific resources. The query message retrieves information about the resources without modifying them, while the *Command* message modifies those settings within the resource that is specified. Settings that are not specified remain unchanged.

5.46.1 Resource Query

The *Resource Query* can be made selective by specifying a *ResourceQuParams* element. The presence of the @*JobID* attribute determines whether global device resources or job-related resources are returned. If no *ResourceQuParams* element is specified, only the global device resources are returned.

The query's response message returns a list of *ResourceInfo* elements that contains the queried information concerning the resources. If the list is empty because the selective query parameters of the *ResourceQuParams* lead to a null selection of the known device/job resources, then the @*ReturnCode* is 103 (@*JobID* unknown), 104 (@*JobPartID* unknown) or 108 (empty list) and SHOULD be flagged as a warning with *Notification* [@*Class*="Warning" and @*Type*="Error"].

Table 5.81: Resource Query Message

OBJECT TYPE	ELEMENT NAME	DESCRIPTION
<i>QueryTypeObj</i>	<i>ResourceQuParams</i> ?	Specifies the resources queried.
<i>ResponseTypeObj</i>	<i>ResourceInfo</i> *	Contains the amount data of resources and if requested, the resources itself.

5.46.1.1 ResourceQuParams

Table 5.82: ResourceQuParams Element (Sheet 1 of 2)

NAME	DATA TYPE	DESCRIPTION
<i>Classes</i> ?	enumerations	List of the resource classes to be queried. For example, in order to query the actual level of consumables in a device outside of any job context, specify <i>@Classes="Consumable"</i> in the query without a <i>@JobID</i> attribute. Default value is: All classes (if <i>@Classes</i> is empty or not specified). Allowed values are from: ▶ ResourceClass.
<i>Context</i> ? New in JDF 1.5 Deprecated in JDF 1.6	enumeration	Specifies the job context of the queried resources. Allowed values are: <i>Job</i> – the query is for all resources in the context of the specified job. <i>Global</i> – the query is for a catalog of all known resources. Deprecation Note: The context is now defined within <i>@Scope</i>
<i>Exact</i> = "false"	boolean	Requests an exact description of the JDF resource. If "true", the response will also return the requested JDF resource.
<i>JobID</i> ? Modified in JDF 1.4	string	<i>JDF/@JobID</i> of the JDF node that is being queried. If no <i>@JobID</i> is specified, the request applies to the currently running process or global resources, depending on the value of <i>@Context</i> .
<i>JobPartID</i> ?	string	<i>JDF/@JobPartID</i> of the JDF node that is being queried. If no <i>@JobPartID</i> is specified, all resources related to <i>@JobID</i> are queried.
<i>Location</i> ?	string	Identifies the location of a resource, such as paper tray, ink container or thread holder. The name is the same name used in the partition key <i>@Location</i> of distributed resources (see also ▶ Section 3.10.6.4 Locations of PhysicalResources). Default value is: the location will be selected by the device Values include those from: ▶ Input Tray and Output Bin Names. Note: The specified values are for printer locations.
<i>LotDetails</i> = "Brief" New in JDF 1.4 Deprecated in JDF 1.6	enumeration	<i>@LotDetails</i> refines the level of information provided about individual lots of the resources. This attribute is most useful when querying an MIS, and SHOULD NOT be specified when querying a device. Allowed values are: <i>Brief</i> – Provides only the <i>@LotControlled</i> attribute in the response indicating whether or not the resources are lot controlled. <i>Full</i> – Provides <i>Lot</i> elements related to the resources. <i>Amount</i> – Same as "Full", but with the addition of the <i>@Amount</i> attribute so the MIS can indicate what the current "on hand" balance for the <i>Lot</i> is in the MIS.
<i>LotID</i> ? New in JDF 1.4 Deprecated in JDF 1.6	string	<i>@LotID</i> of the individual lot of the resource that is queried. Deprecation note: Use <i>Part/@LotID</i>
<i>ProcessUsage</i> ? Modified in JDF 1.6	NMTOKEN	Selects a resource in which <i>ResourceLink/@ProcessUsage</i> matches the token specified. Only necessary if a resource name is used more than once by one node. For example, the <i>Component</i> input <i>ExposedMedia</i> of a <i>ConventionalPrinting</i> process SHALL be distinguished by specifying <i>@ProcessUsage="Plate"</i> and <i>@ProcessUsage="Proof"</i> , respectively. The <i>@ResourceName</i> , <i>@Usage</i> and <i>@ProcessUsage</i> attributes are combined by a logical AND conjunction to select the resource to be queried. Values include those from: ▶ Process Usage.
<i>ProductID</i> ? New in JDF 1.2	string	<i>@ProductID</i> of the resource that is queried.

Table 5.82: ResourceQuParams Element (Sheet 2 of 2)

NAME	DATA TYPE	DESCRIPTION
<i>QueueEntryID</i> ? New in JDF 1.2	string	<i>QueueEntry</i> / <i>@QueueEntryID</i> of the job that is currently being executed, that is being queried. If <i>@QueueEntryID</i> is specified, <i>@JobID</i> , <i>@JobPartID</i> and <i>Part</i> SHALL NOT be specified. If none of <i>@JobID</i> , <i>@JobPartID</i> , <i>Part</i> or <i>@QueueEntryID</i> are specified, <i>ResourceQuParams</i> applies to all jobs.
<i>ResourceDetails</i> = "Full" New in JDF 1.4	enumeration	<i>@ResourceDetails</i> refines the level of information provided about the resources. Allowed values are: <i>Brief</i> – Provides appropriate ID information specific to the type of resource and <i>@DescriptiveName</i> attributes only. For example, <i>@ProductID</i> would be included for <i>Consumable Resource</i> elements that represent consumables, <i>@PersonalID</i> for <i>Employee</i> resources. <i>Full</i> – Provides all of the attributes of the resources.
<i>ResourceID</i> ? New in JDF 1.3 Deprecated in JDF 1.5	NMTOKEN	<i>Resource</i> / <i>@ID</i> of the resource that is queried. Note: The data type is NMTOKEN and not IDREF because the referenced <i>@ID</i> need not be present in the JMF . Deprecation note: Starting with JDF 1.5 , resources SHOULD be identified by <i>@ProductID</i> in <i>Resource</i> JMF messages.
<i>ResourceName</i> ? Modified in JDF 1.4	NMTOKENS	Name of the resource(s) being queried. Values include those from: ▶ Section 8 Resources. Modification note: Starting with JDF 1.4 , the data type was expanded from NMTOKEN to NMTOKENS.
<i>Scope</i> New in JDF 1.4	enumeration	Specifies whether the <i>Response</i> or <i>Signal</i> SHALL return a complete list of all known resources, or the currently loaded resources or the resources related to a specific job. Allowed value is from: ▶ <i>Scope</i> .
<i>Usage</i> ?	enumeration	Selects a resource in which the value of the <i>ResourceLink</i> / <i>@Usage</i> attribute matches the token specified here in this attribute. Only necessary if a resource with a given name is used both as input and output by one node. Allowed values are from: ▶ <i>ResourceUsage</i> .
<i>Part</i> * New in JDF 1.2	element	<i>Part</i> elements that describe the resource whose messages are queried.

Example 5.22: Resource Query about Paper

The following is an example of a press system sending a *Resource Query* to another MIS to get information on all paper known by the MIS.

```
<?xml version="1.0" encoding="UTF-8"?>
<JMF AgentName="CIP4 JDF Writer Java" AgentVersion="1.5 BLD 93"
  MaxVersion="1.6" SenderID="SenderID"
  TimeStamp="2017-08-18T18:23:39+02:00" Version="1.6"
  xmlns="http://www.CIP4.org/JDFSchema_1_1"
  xmlns:xsi="http://www.w3.org/2001/XMLSchema-instance" xsi:type="JMFRootMessage">
  <!--Generated by the CIP4 Java open source JDF Library version : CIP4 JDF Writer Java 1.5 BLD 93-->
  <Query ID="q1" Type="Resource" xsi:type="QueryResource">
    <ResourceQuParams Classes="Consumable" Exact="true"/>
  </Query>
</JMF>
```

Example 5.23: Resource Response about Paper

The following is an example of a **Response** message, containing a **ResourceInfo** element, sent in response to the previous **Resource Query**.

```
<?xml version="1.0" encoding="UTF-8"?>
<JMF AgentName="CIP4 JDF Writer Java" AgentVersion="1.5 BLD 93"
  MaxVersion="1.6" SenderID="SenderID"
  TimeStamp="2017-08-18T18:23:39+02:00" Version="1.6"
  xmlns="http://www.CIP4.org/JDFSchema_1_1"
  xmlns:xsi="http://www.w3.org/2001/XMLSchema-instance" xsi:type="JMFRootMessage">
  <!--Generated by the CIP4 Java open source JDF Library version : CIP4 JDF Writer Java 1.5 BLD 93-->
  <Response ID="r1" Type="Resource" refID="q1" xsi:type="ResponseResource">
    <ResourceInfo>
      <Media Class="Consumable"
        DescriptiveName="more about the paper here"
        ID="r.2784._170818_182339214_000003" Status="Unavailable"/>
    <AmountPool>
      <PartAmount ActualAmount="42">
        <Part LotID="Lot_1" SheetName="Sheet1" SignatureName="Sig1"/>
      </PartAmount>
      <PartAmount ActualAmount="84">
        <Part LotID="Lot_2" SheetName="Sheet1" SignatureName="Sig1"/>
      </PartAmount>
    </AmountPool>
  </ResourceInfo>
</Response>
</JMF>
```

Example 5.24: Resource Query about Employees

The following is an example of a press system sending a **Resource Query** to an MIS to get a list of all known employees in the MIS:

```
<Query ID="M170" Type="Resource" xsi:type="QueryResource">
  <ResourceQuParams ResourceDetails="Brief" ResourceName="Employee"/>
</Query>
```

Example 5.25: Resource Response about Employees

The following is an example of a **Resource** response to the previous **Resource Query**

```
<Response ID="M1001" Type="Resource" refID="M170" xsi:type="ResponseResource">
  <ResourceInfo>
    <Employee Class="Implementation" DescriptiveName="John Allen"
      ID="E01" PersonalID="1034" Status="Available"/>
  </ResourceInfo>
  <ResourceInfo>
    <Employee Class="Implementation" DescriptiveName="Sally Brown"
      ID="E02" PersonalID="1057" Status="Available"/>
  </ResourceInfo>
  <ResourceInfo>
    <Employee Class="Implementation" DescriptiveName="Mike Davison"
      ID="E03" PersonalID="2105" Status="Available"/>
  </ResourceInfo>
  <!-- ... -->
  <ResourceInfo>
    <Employee Class="Implementation" DescriptiveName="Will Smith"
      ID="E04" PersonalID="6410" Status="Available"/>
  </ResourceInfo>
</Response>
```

Example 5.26: Resource Signal about Consumed Resources

The following is an example of a **Resource** signal used to report the inventory identification of the resources that were used:

```
<Signal ID="P172" Type="Resource" xsi:type="SignalResource">
  <ResourceQuParams JobID="34028" JobPartID="_F05A84BD"/>
  <ResourceInfo>
    <Media Brand="Roll Stock" Class="Consumable"
      Dimension="2520 8640000" ID="RI007" MediaType="Paper"
      PartIDKeys="SheetName" ProductID="3002" Status="Available">
      <Media SheetName="1"/>
      <Media SheetName="2"/>
    </Media>
    <AmountPool>
      <PartAmount ActualAmount="4850">
        <Part SheetName="1" LotID="LN1040788312RN20050917-04"/>
      </PartAmount>
      <PartAmount ActualAmount="4850">
        <Part SheetName="1" LotID="LN1040788339RN20050919-01"/>
      </PartAmount>
      <PartAmount ActualAmount="5027">
        <Part SheetName="2" LotID="LN1040788319RN20050917-04"/>
      </PartAmount>
    </AmountPool>
  </ResourceInfo>
</Signal>
```

5.46.2 Resource Command

The **Resource Command** message is used to modify or create either global device settings or resources of a running job. It can be made selective by specifying the OPTIONAL attributes in the **ResourceCmdParams** element. The presence of **ResourceCmdParams/@JobID** determines whether global device resources or job-related resources are modified. If no resource exists in the target **JDF** that matches the filter settings in **ResourceCmdParams**, and **ResourceCmdParams/@JobID** is present, then the specified resource SHALL be created as an input resource to the **JDF** node.

The **Resource** message contains a list of **ResourceInfo** elements with all resources and private extensions of the device after the changes have been applied. The type of the resource that is given as a response depends on the type of the resource given in the command.

If the **Resource Command** message was successful, the value of **@ReturnCode** is "0". If it is not successful, the value of **@ReturnCode** is one of those that have been described in the above section about the **Resource Query** message; or it is "200" (invalid resource parameters) or "201" (insufficient resource parameters). Partial application of the resource SHOULD also be flagged as a warning with **Notification[@Class="Warning" and @Type="Error"]**. If the value of **@ReturnCode** is larger than "0", the controller that issued the command can evaluate the returned resource in order to find the setting that could not be applied.

Table 5.83: Resource Command Message

OBJECT TYPE	ELEMENT NAME	DESCRIPTION
CommandTypeObj	ResourceCmdParams	Specifies the resources to be modified.
ResponseTypeObj	ResourceInfo *	Contains information about the resources after modification.

5.46.2.1 ResourceCmdParams

Table 5.84: ResourceCmdParams Element (Sheet 1 of 2)

NAME	DATA TYPE	DESCRIPTION
<i>Activation</i> = "Active" New in JDF 1.1 Modified in JDF 1.6	enumeration	Describes the activation status of the uploaded resource. Allows for a range of activity, including deactivation and test running of a resource prior to actually committing the change to the device. Values are in order of involvement from least to most active. Allowed value is from: ▶ Activation.
<i>Exact</i> = "false"	boolean	Requests an exact description of the JDF resource. If "true", the response message will also return the requested JDF resource.
<i>JobID</i> ?	string	@ <i>JobID</i> of the JDF node that the resource being modified is linked to. If no @ <i>JobID</i> is specified, global resource settings are modified.
<i>JobPartID</i> ?	string	@ <i>JobPartID</i> of the JDF node that the resource being modified is linked to.
<i>ProcessUsage</i> ?	NMTOKEN	Selects a resource in which the value of the <i>ResourceLink</i> / <i>@ProcessUsage</i> attribute matches the token specified here in this attribute. Only necessary if a resource name is used more than once by one node. For example, the <i>ExposedMedia</i> input resources of a ConventionalPrinting process can be distinguished by specifying @ <i>ProcessUsage</i> ="Plate" and @ <i>ProcessUsage</i> ="Proof", respectively. The @ <i>ResourceName</i> , @ <i>Usage</i> and @ <i>ProcessUsage</i> attributes are combined by a logical AND conjunction to select the resource to be modified. Values include those from: ▶ Process Usage.
<i>ProductID</i> ? New in JDF 1.2	string	@ <i>ProductID</i> of the resource that is updated.
<i>ProductionAmount</i> ?	double	New requested amount of resource production. This value replaces the <i>ResourceLink</i> / <i>@Amount</i> of the selected resource.
<i>QueueEntryID</i> ? New in JDF 1.2	string	@ <i>QueueEntryID</i> of the job that is currently being executed. If @ <i>QueueEntryID</i> is specified, @ <i>JobID</i> , @ <i>JobPartID</i> and <i>Part</i> are ignored. If none of @ <i>JobID</i> , @ <i>JobPartID</i> , <i>Part</i> or @ <i>QueueEntryID</i> are specified, <i>ResourceCmdParams</i> applies to global resources.
<i>ResourceID</i> ? New in JDF 1.3 Deprecated in JDF 1.5	NMTOKEN	<i>Resource</i> / <i>@ID</i> the resource that is modified. If both @ <i>ResourceID</i> and <i>Resource</i> are specified, resources with a non-matching <i>Resource</i> / <i>@ID</i> SHALL NOT be updated. Note: The data type is NMTOKEN and not IDREF because the referenced @ <i>ID</i> NEED NOT be present in the JMF . Deprecation note: Starting with JDF 1.5, resources SHOULD be identified by @ <i>ProductID</i> in <i>Resource</i> JMF messages.
<i>ResourceName</i> ?	NMTOKEN	Name of the resource whose production amount will be modified. Values include those from: ▶ Chapter 8 Resources.
<i>Status</i> ? New in JDF 1.2	enumeration	Updated @ <i>Status</i> of the selected resource. Values include those from: ▶ ResourceStatus.
<i>UpdateIDs</i> ? New in JDF 1.1 Deprecated in JDF 1.3	NMTOKENS	The @ <i>UpdateID</i> attributes of one or more <i>ResourceUpdate</i> that are defined in resources known to the recipient. The data type is NMTOKENS and not IDREFS because no matching IDs exist within this message. The order of tokens in defines the order in which the updates are applied.

Table 5.84: ResourceCmdParams Element (Sheet 2 of 2)

NAME	DATA TYPE	DESCRIPTION
UpdateMethod = "Complete" New in JDF 1.3 Modified in JDF 1.4	enumeration	<p>@UpdateMethod specifies how the resource is updated. Attributes that are required to correctly identify the resource SHALL be specified, even if @UpdateMethod="Remove" or @UpdateMethod="Incremental". These attributes include @ProductID, @Class, @PartIDKeys, and any partition keys.</p> <p>Allowed values are:</p> <p>Complete – The resource partitions defined by Part are completely overwritten by Resource in this message.</p> <p>Incremental – The resource partitions defined by Part are incrementally updated by the values that are explicitly set in Resource in this message.</p> <p>Remove – The resources or resource partitions are removed. New in JDF 1.4</p>
Usage ? New in JDF 1.4	enumeration	<p>Selects a resource in which the value of the ResourceLink/@Usage attribute matches the token specified here in this attribute. Only necessary if a resource name is used both as input and output by one node.</p> <p>Allowed values are from: ▶ ResourceUsage.</p>
MISDetails ? New in JDF 1.2	element	<p>Definition how the costs for the modification of the Resource are to be charged.</p>
Part * New in JDF 1.2	element	<p>Part elements that describe the partitions of the resource that is being modified. If not specified, the entire resource is selected. If a resource is the final instance of set of partitioned resources, and thus the properties of the partition that represents the set are modified in addition to the properties of the instance, then the Part that represents the set SHOULD also be specified explicitly.</p> <p>For example, if the fourth plate of a four color process set is now available, and thus the entire surface is now available, Part elements for both the fourth plate and for the entire surface SHOULD be specified. If the other surface is also available, then a Part element for the sheet SHOULD be specified as well.</p>
Resource *	element	<p>Resources to be uploaded to the device. They replace the original resources according to the policy specified in @UpdateMethod. The resource SHOULD be identified by ResourceCmdParams/@ResourceName, ResourceCmdParams/@Usage, ResourceCmdParams/@ProcessUsage or ResourceCmdParams/@ProductID.</p> <p>The data type and @Class of Resource MAY be derived from the Abstract Resource. See ▶ Section 3.8.3 Abstract Resource.</p>

Example 5.27: Resource Command: Single Resource is Available

The following is an example for specifying that the Cyan, Front plate of *Sheet2*, signature 1 has become available.

```
<Command ID="C1" Type="Resource" xsi:type="CommandResource">
  <ResourceCmdParams JobID="MakeBrochure 012" ResourceID="ExposedMediaID">
    <Part Separation="Cyan" SheetName="Sheet2" Side="Front" SignatureName="Sig1"/>
  </ResourceCmdParams>
</Command>
```

Example 5.28: Resource Command: Multiple Resources are Available

The following is an example for specifying that the Black, Front plate of *Sheet2*, signature 1 has become available and is also the last plate of Sheet 2.

```
<Command ID="C2" Type="Resource" xsi:type="CommandResource">
  <ResourceCmdParams JobID="MakeBrochure 012" ResourceID="ExposedMediaID">
    <Part Separation="Black" SheetName="Sheet2" Side="Front" SignatureName="Sig1"/>
    <!-- the entire front of Sheet2 is also available -->
    <Part SheetName="Sheet2" Side="Front" SignatureName="Sig1"/>
    <!-- the entire Sheet2 is also available -->
    <Part SheetName="Sheet2" SignatureName="Sig1"/>
  </ResourceCmdParams>
</Command>
```

5.46.2.2 ResourceInfo

Table 5.85: ResourceInfo Element (Sheet 1 of 3)

NAME	DATA TYPE	DESCRIPTION
<i>ActualAmount</i> ? New in JDF 1.2	double	When querying a device, this attribute reflects the current accumulated amount of the resource that has been consumed (input) or produced (output) by the process. This corresponds to the current value of <i>ResourceLink</i> / <i>@ActualAmount</i> if it would be written now. <i>@ActualAmount</i> SHALL NOT be specified if <i>@Scope</i> ="Estimate". When querying an MIS, this attribute SHOULD NOT be specified.
<i>Amount</i> ?	double	When querying a device, this attribute reflects the intended accumulated amount of the resource that will be consumed (input) or produced (output) by the process. This corresponds to the current value of <i>ResourceLink</i> / <i>@Amount</i> if it would be written now. When querying an MIS, this attribute specifies the amount of the <i>Consumable Resource</i> that is available in inventory.
<i>AvailableAmount</i> ?	double	When querying a device, this attribute specifies the device-specific amount of the <i>Consumable Resource</i> that is available in the device. When querying an MIS, this attribute specifies the amount of the <i>Consumable Resource</i> that is available in inventory
<i>CommandResult</i> ? New in JDF 1.4	enumeration	Result of a <i>Resource Command</i> . Allowed values are: Merged – Values from the resource in <i>ResourceCmdParams</i> were merged into an existing resource. See the <i>ResourceInfo/Resource</i> for the merged result. New – A new resource with the values specified in <i>ResourceCmdParams</i> was created. Rejected – The <i>Resource Command</i> was not applied to this resource. Removed – An existing resource was removed completely by a resource specified in <i>ResourceCmdParams</i> . Replaced – An existing resource was replaced completely by a resource specified in <i>ResourceCmdParams</i> .
<i>DeviceID</i> ? New in JDF 1.5	NMTOKEN	Used to disambiguate the location of a resource when a controller is returning cumulative resource information from its controlled devices.
<i>Level</i> ? Modified in JDF 1.4 Modified in JDF 1.6	enumeration	Level of the consumable or output bin that is represented by this <i>ResourceInfo</i> for the device. Allowed values are: Empty – The bin is empty. Full – The bin is full. New in JDF 1.6 High – The output bin is filling up and can soon be Full . This value is for output levels only and SHOULD NOT be specified for input resources. New in JDF 1.6 Low – The resources are running low and can soon be Empty . This value is for input levels only and SHOULD NOT be specified for output bins. OK – Specification is left to the device manufacturer. Modification note: Starting with JDF 1.4 , the default of "OK" is removed to allow job independent resource information.
<i>Location</i> ?	string	Device-specific string to identify the location of a given consumable, such as paper tray, ink container or thread holder. The name is the same name used in the partition key <i>@Location</i> of distributed resources (see also ▶ Section 3.10.6.4 Locations of PhysicalResources). Default value is: the location will be selected by the device Values include those from: ▶ Input Tray and Output Bin Names. Note: The specified values are for printer locations.
<i>LotControlled</i> ? New in JDF 1.4	boolean	Indicates that the resource is lot controlled.

Table 5.85: ResourceInfo Element (Sheet 2 of 3)

NAME	DATA TYPE	DESCRIPTION
<i>ModuleID</i> ? New in JDF 1.3	string	@ <i>ModuleID</i> of the module that the Resource is consumed or produced by. If neither of @ <i>ModuleID</i> or @ <i>ModuleIndex</i> are specified, defaults to the entire device specified by <i>JMF</i> / <i>@SenderID</i> .
<i>ModuleIndex</i> ? New in JDF 1.3	IntegerRangeList	The 0-based indices of the module or modules that the Resource is consumed or produced by. If neither of @ <i>ModuleID</i> or @ <i>ModuleIndex</i> are specified, defaults to the entire device specified by <i>JMF</i> / <i>@SenderID</i> .
<i>Orientation</i> ? New in JDF 1.5	enumeration	Named orientation describing the orientation of the Resource relative to the ideal process coordinate that uses this Resource . @ <i>Orientation</i> can be used to describe orientation dependent resources such as paper in a paper tray. Allowed value is from: ▶ Orientation.
<i>ProcessUsage</i> ?	NMTOKEN	Selects a resource in which the value of the <i>ResourceLink</i> /@ <i>ProcessUsage</i> attribute matches the token specified here in this attribute. Only necessary if a resource name is used more than once by one node. For example, the ExposedMedia input resources of a ConventionalPrinting process can be distinguished by specifying @ <i>ProcessUsage</i> ="Proof" and @ <i>ProcessUsage</i> ="Plate", respectively. The @ <i>ResourceName</i> and @ <i>ProcessUsage</i> attributes are combined by a logical AND conjunction to select the resource to be queried. Values include those from: ▶ Process Usage.
<i>ProductID</i> ? New in JDF 1.2	string	@ <i>ProductID</i> of the resource.
<i>ResourceID</i> ? New in JDF 1.3 Deprecated in JDF 1.5	NMTOKEN	<i>Resource</i> / <i>@ID</i> of the resource. Note: The data type is NMTOKEN and not IDREF because the referenced @ <i>ID</i> NEED NOT be present in the <i>JMF</i> . Deprecation note: Starting with JDF 1.5 , resources SHOULD be identified by @ <i>ProductID</i> in Resource <i>JMF</i> messages.
<i>ResourceName</i> ?	NMTOKEN	Name of the resource if @ <i>Exact</i> ="false" in the query. @ <i>ResourceName</i> specifies the primary resource that this ResourceInfo applies to. Additional resources MAY be specified to ensure complete references from the primary resource. Values include those from: ▶ Chapter 8 Resources.
<i>Scope</i> ? New in JDF 1.5	enumeration	@ <i>Scope</i> specifies the context of the resources defined in this ResourceInfo . Allowed value is from: ▶ Scope.
<i>Speed</i> ? New in JDF 1.6	double	The current speed at which the resource that this ResourceInfo describes is being consumed or produced. @ <i>Speed</i> SHALL be defined in the units specified by @ <i>Unit</i> / hour.
<i>Status</i> ? New in JDF 1.2	enumeration	Updated @ <i>Status</i> of the selected resource. Allowed values are from: ▶ ResourceStatus.
<i>TotalAmount</i> ? New in JDF 1.6	double	@ <i>TotalAmount</i> specifies the job independent total counter setting for a given type of resource. Note: This allows tracking of power consumption without requiring a device to track it individually for each job.
<i>Transformation</i> ? New in JDF 1.6	matrix	@ <i>Transformation</i> describes the transformation of the orientation of the Resource (described by this ResourceInfo) relative to the ideal process coordinate system that uses this Resource as an input or output.
<i>Unit</i> ?	string	Unit of the amount attributes. In a job context it is strongly discouraged to specify a unit other than the unit defined in the respective JDF resource, although this might be necessary due to technical considerations, such as when ink is specified in weight (g) and ink measurement is specified in volume (liter). Values include those from: ▶ Units.

Table 5.85: ResourceInfo Element (Sheet 3 of 3)

NAME	DATA TYPE	DESCRIPTION
<i>Usage</i> ? New in JDF 1.3	enumeration	Specifies a resource in which the value of the <i>ResourceLink/@Usage</i> attribute matches the value of this attribute. Only required if a resource name is used both as input and output by one node. Allowed values are from: ▶ ResourceUsage.
<i>AmountPool</i> ? New in JDF 1.3	element	Definition of partial amounts and pipe parameters for this <i>Resource</i> . The contents of the <i>AmountPool</i> are described for the various types of <i>ResourceLink</i> elements in ▶ Table 3.15 AmountPool Element. If <i>AmountPool</i> is specified, the <i>ResourceInfo</i> SHALL NOT contain any of the amount related attributes defined in <i>AmountPool/PartAmount</i> .
<i>CostCenter</i> ?	element	Cost center to which the resource consumption is allocated.
<i>Lot</i> * New in JDF 1.4 Deprecated in JDF 1.6	element	Used when a device is querying a controller to determine what lots exist for the resource being queried. When a device is the sender of this message, lot information is specified in the <i>AmountPool</i> , and SHALL NOT be specified here.
<i>MISDetails</i> ? New in JDF 1.2	element	Definition of how the costs for the production of the <i>Resource</i> are to be charged.
<i>Part</i> * New in JDF 1.4	element	<i>Part</i> elements that describe the resource. Creation note: Starting with JDF 1.4, <i>Part</i> is back after being deprecated in JDF 1.3.
<i>Resource</i> * Modified in JDF 1.4	element	JDF description of the resource. If the query or command leading to this response message element contains <i>Part</i> elements, the resource SHALL contain only the appropriate matching partitions. The data type and <i>@Class</i> of <i>Resource</i> is derived from the abstract resource. See ▶ Section 3.8.3 Abstract Resource. Modification note: Starting with JDF 1.4, there can be multiple occurrences of <i>Resource</i> elements. See <i>@ResourceName</i> for the reason.

Example 5.29: Resource Query for Consumables

The following is an example for retrieving settings:

```
<Query ID="Q1" Type="Resource" xsi:type="QueryResource">
  <ResourceQuParams Classes="Consumable" Exact="true"/>
</Query>
```

Example 5.30: Resource Response about Consumables

The following is a possible response message to the query message above:

```
<Response ID="M1" Type="Resource" refID="Q1" xsi:type="ResponseResource">
  <ResourceInfo AvailableAmount="2120" Location="Paper Tray 1">
    <Media Class="Consumable" ID="ID123" Status="Available">
      <!-- Media resource defined in JDF -->
    </Media>
  </ResourceInfo>
  <ResourceInfo AvailableAmount="0" Level="Empty" Location="Ink1" Unit="l">
    <Ink Class="Consumable" ID="ID124" Status="Available">
      <!-- Ink description resource defined in JDF -->
    </Ink>
  </ResourceInfo>
</Response>
```

Example 5.31: Resource Command for Changing Amount

The following is an example for modifying the production amount of a specific job to produce brochures.

```
<Command ID="C1" Type="Resource" xsi:type="CommandResource">
  <ResourceCmdParams JobID="MakeBrochure 012" ProductionAmount="7500" ResourceName="Component"/>
</Command>
```

Example 5.32: Resource Response for Changing Amount

The following is a possible response to the [Resource Command](#) message above.

```
<Response ID="M2" Type="Resource" refID="C1" xsi:type="ResponseResource">
  <ResourceInfo Amount="7500" ResourceName="Component"/>
</Response>
```

5.47 ResourcePull

New in JDF 1.2

The [ResourcePull](#) message requests a resource from a controller or device. The resource is specified as the output resource of a **JDF** node. The requested resource MAY be a subset of the resource specified in the original **JDF**. The [ResourcePullParams](#) element provides the parameters. The command can be used to regenerate the output of a [QueueEntry](#) or **JDF** node with any [@Status](#).

If the [ResourcePull](#) is accepted, the respective [QueueEntry](#) is re-queued with [QueueEntry/@Status="Waiting"](#). After processing, the processing result SHALL be sent to the original submitter of the [QueueEntry](#) that is being repeated using a [ReturnQueueEntry](#) message. The sender of the [ResourcePull](#) message SHOULD be informed of the completion of the [ResourcePull](#) message with a [Resource Command](#).

Workflow Integration with ResourcePull

When [ResourcePull](#) is submitted directly to a device in a workflow that is monitored by an MIS system, the MIS system SHALL be informed about the re-execution of the **JDF** node, so that it can update the state of the entire job appropriately.

Note: It is preferred to pull a resource from a device in a workflow that is monitored by an MIS system by sending the [ResourcePull](#) message to the MIS. The MIS can then control the device in the standard manner and also maintain consistency of its internal job representation.

Table 5.86: ResourcePull Message

OBJECT TYPE	ELEMENT	DESCRIPTION
CommandTypeObj	QueueFilter Deprecated in JDF 1.5	Defines a filter for the returned Queue element in the ResourcePull message.
	ResourcePullParams	Defines the parameters of the repeated job.
ResponseTypeObj	Queue Deprecated in JDF 1.5	Describes the state of the queue after the command has been executed.
	QueueEntry	Provides the queue entry of the repeated job.

5.47.1 ResourcePullParams

The **ResourcePullParams** MAY contain queue-ordering attributes equivalent to those used by the **SetQueueEntryPriority** and **SetQueueEntryPosition** messages. The OPTIONAL list of **Part** elements refers to the output resource that is produced by the **JDF** node.

Table 5.87: ResourcePullParams Element

NAME	DATA TYPE	DESCRIPTION
<i>Amount</i> ?	double	The <i>@Amount</i> attribute identifies the amount of the output resource to be created by the JDF node that is executed by the cloned QueueEntry . This <i>@Amount</i> is the amount to be produced by the process that is executed due to the ResourcePull . Thus if 200 copies had been created previously and 100 copies are requested by the ResourcePull , <i>@Amount</i> ="100" and not "300".
<i>Hold</i> = "false"	boolean	If "true", the entry is submitted as held.
<i>JobID</i> ?	string	<i>@JobID</i> of the JDF node that creates the requested resource. If <i>@QueueEntryID</i> is specified, <i>@JobID</i> is ignored. Exactly one of <i>@JobID</i> or <i>@QueueEntryID</i> SHALL be specified.
<i>NextQueueEntryID</i> ?	string	ID of the queue entry that SHALL be positioned directly behind the entry.
<i>PrevQueueEntryID</i> ?	string	ID of the queue entry that SHALL be positioned directly in front of the entry.
<i>Priority</i> = "1"	integer	Number from 0 to 100, where 0 is the lowest priority and 100 is the maximum priority.
<i>QueueEntryID</i> ?	string	<i>@QueueEntryID</i> of the JDF node that creates the requested resource. If <i>@QueueEntryID</i> is specified, <i>@JobID</i> and Part are ignored. Exactly one of <i>@JobID</i> or <i>@QueueEntryID</i> SHALL be specified.
<i>RepeatPolicy</i> ?	enumeration	Policy that defines how to reuse intermediate resources that were generated in the original processing step (e.g., intermediate raster files in a combined RIP and ImageSetting process). Allowed values are: Complete – Restart from the original input resources if they are available. The process can run based on intermediate resources if no original resources are available. CompleteOnly – Restart from the original input resources. The process SHALL NOT run if any original resources are not available. Fast – Reuse as many intermediate resources as possible (e.g., restart Image-Setting from stored intermediate raster files and do not reRIP if possible).
<i>ResourceID</i>	string	ID attribute of the resource requested.
<i>ReturnURL</i> ? Deprecated in JDF 1.4	URL	URL where the JDF file SHALL be written when the job is completed or aborted. If not specified, the JDF SHALL be placed in the default output hot folder of the queue controller. If <i>@ReturnURL</i> is specified with the "file" scheme, <i>@ReturnURL</i> SHALL specify an individual file. <i>@ReturnURL</i> takes precedence when <i>NodeInfo/@TargetRoute</i> is specified in the previously submitted JDF .
<i>WatchURL</i> ? Deprecated in JDF 1.4	URL	URL of the controller that SHALL be notified when the status of the QueueEntry or the underlying job changes. Specifying <i>@WatchURL</i> is equivalent to sending a Subscription for an Events message with <i>@SignalTypes</i> = "All".
<i>Disposition</i> ?	element	Specifies how long the QueueEntry SHOULD be retained in the queue. If not specified, the QueueEntry MAY be removed from the queue immediately after process completion of the QueueEntry .
<i>MISDetails</i> ?	element	Definition how the costs for the production of the Resource are to be charged.
Part *	element	The Part elements identify the parts of a partitioned output resource to be created by the JDF node. The structure of the Part element is defined in ▶ Table 3.23 Part Element. For details on partitioned resources, see ▶ Section 3.10.5 Description of Partitioned Resources. For details on node partitions, see ▶ Section 4.3.2 Partial processing of nodes with Partitioned resources.

Example 5.33: ResourcePull Command

For example, if an **ImageSetting** process produces a partitioned set of plates, the following example message would request only the yellow plate of the "Front" @Surface of *Sheet1*.

```
<Command ID="C3" Type="ResourcePull" xsi:type="CommandResourcePull">
  <ResourcePullParams Priority="100" QueueEntryID="AllPlates" ResourceID="R42">
    <Part Separation="Yellow" SheetName="Sheet1" Side="Front"/>
  </ResourcePullParams>
</Command>
```

5.48 ResubmitQueueEntry

A job is resubmitted to a queue using the **ResubmitQueueEntry** message. This allows late changes to be made to a job without affecting queue parameters and without exporting the internal structure of a queue. Resubmission overwrites the job with **JDF** information specified in **ResubmissionParams/@URL**. If **QueueEntry/@Status** is neither "Waiting" nor "Held", resubmitting a queue entry MAY fail because a device NEED NOT implement **ResubmitQueueEntry** for running queue entries. Resubmission does not affect other queue parameters as specified. For example, resubmission does not affect queue ordering. For details, see ▶ Table 5.20 Status Transitions for QueueEntry Handling Messages.

Table 5.88: ResubmitQueueEntry Message

OBJECT TYPE	ELEMENT NAME	DESCRIPTION
CommandTypeObj Modified in JDF 1.2	QueueFilter ? New in JDF 1.2 Deprecated in JDF 1.5	Defines a filter for the returned Queue element in the ResubmitQueueEntry message.
	ResubmissionParams	Defines the job resubmission.
ResponseTypeObj Modified in JDF 1.5	Queue Deprecated in JDF 1.5	Describes the state of the queue after the command has been executed.

5.48.1 ResubmissionParams

Table 5.89: ResubmissionParams Element

NAME	DATA TYPE	DESCRIPTION
QueueEntryID	string	ID of the queue entry to be replaced.
URL	URL	Location of the JDF to be submitted. It MAY be a URL with a "cid" scheme in the case of MIME Multipart/Related.

5.49 ResumeQueue

The queue is activated and queue entries can be executed. The **ResumeQueue** command message is the opposite of a **HoldQueue** command message.

Table 5.90: ResumeQueue Message (Sheet 1 of 2)

OBJECT TYPE	ELEMENT NAME	DESCRIPTION
CommandTypeObj Modified in JDF 1.5	QueueFilter ? New in JDF 1.2 Deprecated in JDF 1.5	Defines a filter for the ResumeQueue message.

Table 5.90: ResumeQueue Message (Sheet 2 of 2)

OBJECT TYPE	ELEMENT NAME	DESCRIPTION
ResponseTypeObj Modified in JDF 1.5	Queue Deprecated in JDF 1.5	Describes the state of the queue after the command has been executed.

5.50 ResumeQueueEntry

The hold status of the queue entries specified by [ResumeQueueEntryParams/QueueFilter/QueueEntryDef](#) has been removed. A [QueueEntry](#) with `@Status="Held"` gets a `@Status` of `"Waiting"`. A [QueueEntry](#) with `@Status="Suspended"` gets a `@Status` of `"Running"`. If [QueueEntry/@GangPolicy](#) is other than `"NoGang"`, a resumed [QueueEntry](#) joins its respective gang. For details, see ▶ Table 5.20 Status Transitions for QueueEntry Handling Messages.

Table 5.91: ResumeQueueEntry Message

OBJECT TYPE	ELEMENT NAME	DESCRIPTION
CommandTypeObj Modified in JDF 1.5	QueueEntryDef Deprecated in JDF 1.5	Defines the queue entry. Deprecation note: Starting with JDF 1.5, this QueueEntryDef SHOULD be located in ResumeQueueEntryParams/QueueFilter .
	QueueFilter ? New in JDF 1.2 Deprecated in JDF 1.5	Defines a filter for the returned Queue element in the ResumeQueueEntry message.
	ResumeQueueEntryParams ? New in JDF 1.5	
ResponseTypeObj Modified in JDF 1.5	Queue Deprecated in JDF 1.5	Describes the state of the queue after the command has been executed.

5.50.1 ResumeQueueEntryParams

New in JDF 1.5

Table 5.92: ResumeQueueEntryParams Element

NAME	DATA TYPE	DESCRIPTION
QueueFilter ?	element	This QueueFilter selects the QueueEntry elements to apply the ResumeQueueEntry message to.

5.51 ReturnQueueEntry

New in JDF 1.2

The [ReturnQueueEntry](#) message returns a job that had been submitted with a [SubmitQueueEntry](#) to the queue that represents the controller that originally submitted the job. The [ReturnQueueEntryParams](#) element provides the parameters. **Note:** This command is emitted from the device that is represented by the queue to a controller or dispatcher and not to the queue, as is the case with most other queue handling commands.

Table 5.93: ReturnQueueEntry Message (Sheet 1 of 2)

OBJECT TYPE	ELEMENT NAME	DESCRIPTION
CommandTypeObj	ReturnQueueEntryParams	Defines the job being returned from device to controller after processing is completed or aborted.

Table 5.93: ReturnQueueEntry Message (Sheet 2 of 2)

OBJECT TYPE	ELEMENT NAME	DESCRIPTION
ResponseTypeObj	-	

5.51.1 ReturnQueueEntryParams

The [@URL](#) attribute specifies the location where the **JDF** file to be returned can be retrieved by the controller. The scheme of the [@URL](#) attribute (such as "file", "http" or "cid") SHALL define the retrieval method to be used to retrieve the **JDF**.

Table 5.94: ReturnQueueEntryParams Element

NAME	DATA TYPE	DESCRIPTION
Aborted ?	NMTOKENS	ID of the JDF nodes that have been executed and aborted or failed test running. If @Aborted and @Completed are empty, no executable node was found. Note that the data type of this attribute was erroneously specified as IDREFS in JDF 1.2. and JDF 1.3.
Completed ?	NMTOKENS	ID of the JDF nodes that have been executed and completed or succeeded in test run. Note that the data type of this attribute was erroneously specified as IDREFS in JDF 1.2. and JDF 1.3.
Priority ?	integer	The priority of the QueueEntry when it was executed on the device. The controller receiving this message MAY prioritize this job for continued processing based on this value.
QueueEntryID	string	QueueEntry / @QueueEntryID of the returned queue entry. Note that this attribute was erroneously omitted in JDF 1.2. and JDF 1.3.
URL	URL	Location of the JDF to be returned. Note that the @URL SHOULD be queried with a SubmissionMethods query message to determine whether MIME Multipart/Related is supported

5.52 SetQueueEntryPosition

The position of the queue entry is modified. The [QueueEntryPosParams](#) element provides the parameters. The position of a queue entry SHALL NOT be modified unless [@Status](#)="Waiting" or [@Status](#)="Held". For details, see ▶ Table 5.20 Status Transitions for QueueEntry Handling Messages.

Table 5.95: SetQueueEntryPosition Message

OBJECT TYPE	ELEMENT NAME	DESCRIPTION
CommandTypeObj Modified in JDF 1.2	QueueEntryPosParams	Defines the queue entry.
	QueueFilter ? New in JDF 1.2 Deprecated in JDF 1.5	Defines a filter for the returned Queue element in the SetQueueEntryPosition message.
ResponseTypeObj Modified in JDF 1.5	Queue Deprecated in JDF 1.5	Describes the state of the queue after the command has been executed.

5.52.1 QueueEntryPosParams

[@QueueEntryID](#) specifies the queue entry to be moved. Jobs can either be set to a specific position within the queue or positioned next to an existing queue entry. The priority of the entry matches the priority of the entry that precedes it, after it has been repositioned.

Table 5.96: QueueEntryPosParams Element

NAME	DATA TYPE	DESCRIPTION
NextQueueEntryID ?	string	ID of the queue entry that SHALL be positioned directly behind the entry. Exactly one of @NextQueueEntryID , @PrevQueueEntryID or @Position SHALL be specified.
PrevQueueEntryID ?	string	ID of the queue entry that SHALL be positioned directly in front of the entry. Exactly one of @NextQueueEntryID , @PrevQueueEntryID or @Position SHALL be specified.
Position ?	integer	Position in the queue. "0"=pole position. Note that the position is based on the queue before modification. Thus if a queue entry is moved back in the queue, its final position is one lower than specified in @Position . Exactly one of @NextQueueEntryID , @PrevQueueEntryID or @Position SHALL be specified.
QueueEntryID	string	ID of a queue entry.

5.53 SetQueueEntryPriority

The priority of the queue entry is modified. The [QueueEntryPriParams](#) element provides the parameters. For details, see [Table 5.20 Status Transitions for QueueEntry Handling Messages](#).

Table 5.97: SetQueueEntryPriority Message

OBJECT TYPE	ELEMENT NAME	DESCRIPTION
CommandTypeObj Modified in JDF 1.5	QueueEntryPriParams	Defines the queue entry.
	QueueFilter ? New in JDF 1.2 Deprecated in JDF 1.5	Defines a filter for the returned Queue element in the SetQueueEntryPriority message.
ResponseTypeObj Modified in JDF 1.5	Queue Deprecated in JDF 1.5	Describes the state of the queue after the command has been executed.

5.53.1 QueueEntryPriParams

[@QueueEntryID](#), described in the table below, specifies the queue entry that has its priority modified.

Table 5.98: QueueEntryPriParams Element

NAME	DATA TYPE	DESCRIPTION
Priority	integer	Number from 0 to 100, where "0" is the lowest priority and "100" is the maximum priority. The priority from QueueSubmissionParams/@Priority and QueueEntryPriParams/@Priority takes precedence over NodeInfo/@JobPriority .
QueueEntryID Deprecated in JDF 1.5	string	ID of a queue entry.
QueueFilter ? New in JDF 1.5	element	This QueueFilter selects the QueueEntry elements to apply the SetQueueEntryPriority message to.

5.54 ShutDown

New in JDF 1.2

The **ShutDown** command message shuts down a controller or device. A device SHALL use the **Status** message if it signals its own shutdown.

Table 5.99: ShutDown Message

OBJECT TYPE	ELEMENT	DESCRIPTION
CommandTypeObj	QueueFilter Deprecated in JDF 1.5	Defines a filter for the returned Queue element in the ShutDown message.
	ShutDownCmdParams	Defines the details of a shutdown.
ResponseTypeObj	DeviceInfo	Describes the device status as anticipated after the shut-down.
	Queue Deprecated in JDF 1.5	Provides information about the queue and all its entries as anticipated after the shutdown. This element will only be provided if the device has queue capabilities. The queue element is described in ▶ Section 5.14 Elements for Queues.

5.54.1 ShutDownCmdParams

Table 5.100: ShutDownCmdParams Element

NAME	DATA TYPE	DESCRIPTION
ShutDownType = "StandBy"	enumeration	Defines the device shutdown method. Allowed values are: Full – Completely shut down the device. It is no longer accessible via JMF after the shutdown. DeviceInfo/@DeviceStatusDetails SHOULD be "ShutDown". DeviceInfo/@DeviceStatus SHALL be "Down". StandBy – The device is set to standby mode. It can be restarted with a WakeUp JMF message. DeviceInfo/@DeviceStatusDetails SHOULD be "StandBy". If the device requires a WakeUp JMF prior to accepting new jobs, DeviceInfo/@DeviceStatus SHALL be "Down", else it SHALL be "Idle".
FlushQueueParams ?	element	Defines the policy for flushing the queue upon shutdown. If not specified, the queue is not flushed. The behavior of a queue after shutdown is system specific.

5.55 Status

The **Status** message queries the general status of a device or a controller and the status of jobs associated with this device or controller. No job context is needed to issue a **Status** message. The response SHOULD contain one or more **DeviceInfo** elements, which contain the device specific information and which MAY contain other **JobPhase** elements that in turn contain the job specific information.

Table 5.101: Status Message

OBJECT TYPE	ELEMENT NAME	DESCRIPTION
QueryTypeObj	StatusQuParams	Refines the query to include various aspects of the device and job states.
ResponseTypeObj	DeviceInfo +	Describes the actual device status. If multiple DeviceInfo elements are specified, these describe multiple devices. A sequential state change of an individual device SHALL be encoded as 2 separate signals.
	Queue ? Deprecated in JDF 1.6	Provides information about the queue and all its entries. This element will only be provided if the device has queue capabilities. The Queue element is described in ▶ Section 5.14 Elements for Queues.

5.55.1

Example 5.34: Status Signal

New in JDF 1.4

Example of a status signal for a phase switch from setup to running

```
<JMF MaxVersion="1.6" SenderID="MIS master A"
  TimeStamp="2007-08-09T11:35:41+02:00" Version="1.6"
  xmlns="http://www.CIP4.org/JDFSchema_1_1" xmlns:xsi="http://www.w3.org/2001/XMLSchema-in-
stance">
  <Signal ID="m18" Type="Status" xsi:type="SignalStatus">
    <DeviceInfo DeviceStatus="Running">
      <JobPhase JobID="jID" JobPartID="jpID"
        PhaseStartTime="2007-08-09T11:35:40+02:00" Status="Setup"/>
    </DeviceInfo>
  </Signal>
  <Signal ID="m19" Type="Status" xsi:type="SignalStatus">
    <DeviceInfo DeviceStatus="Running">
      <JobPhase JobID="jID" JobPartID="jpID"
        PhaseStartTime="2007-08-09T11:35:41+02:00" Status="InProgress"/>
    </DeviceInfo>
  </Signal>
</JMF>
```

5.55.2 StatusQuParams

StatusQuParams is a filter that refines the level of information that SHALL be returned in the response or signals.

Table 5.102: StatusQuParams Element (Sheet 1 of 2)

NAME	DATA TYPE	DESCRIPTION
<i>DeviceDetails</i> = "None"	enumeration	Refines the provided status information about the device. Allowed values are: None – <i>DeviceInfo/@DeviceID</i> and <i>DeviceInfo/@DeviceStatus</i> SHALL be provided. Other <i>DeviceInfo</i> attributes MAY be provided. <i>DeviceInfo/Employee</i> , <i>DeviceInfo/Device</i> and <i>DeviceInfo /ModuleStatus</i> elements SHALL NOT be provided. Brief – Provide all available device information except for <i>Device</i> elements. The provided information includes <i>JobPhase</i> and <i>Activity</i> elements. Modules – Provide <i>ModuleStatus</i> elements with module specific status details. Details – Provide maximum available device information excluding device capability descriptions. Includes <i>Device</i> elements which represent details of the device. Capability – Provide <i>Device</i> elements with <i>DeviceCap</i> subelements which represent details of the capabilities of the device. Full – Provide maximum available device information including device capability descriptions. Includes <i>Device</i> elements which represent details of the device.
<i>EmployeeInfo</i> = "false"	boolean	If "true", <i>Employee</i> elements are to be provided in the response. Those elements describe the employees which are associated to the device independent on any job.
<i>JobDetails</i> = "None"	enumeration	Refines the provided status information about the jobs associated with the device. Each higher entry includes the values specified in the lower entries. Allowed values are: None – <i>JobPhase/@JobID</i> , <i>JobPhase/@JobPartID</i> SHALL be specified if a job is running. <i>JobPhase/Part</i> SHOULD be specified if a job is running. At least one of <i>JobPhase/@Amount</i> and <i>JobPhase/@PercentCompleted</i> SHALL be specified if a job is running. Additional job related data SHOULD NOT be specified. MIS – Provide business with the relevant information contained in the <i>CostCenter</i> element and the <i>@Deadline</i> , <i>@DeviceStatus</i> , <i>@Status</i> , <i>@StatusDetails</i> and the various <i>@Counter</i> attributes. In JDF 1.2 and beyond, this value is identical to "Brief". Deprecated in JDF 1.2 Brief – Provide all available status information including <i>JobPhase</i> and <i>Activity</i> elements except for JDF . Full – Provide maximum available status information. Includes a URL reference to an actual JDF which represents a snapshot of the current job state.

Table 5.102: StatusQuParams Element (Sheet 2 of 2)

NAME	DATA TYPE	DESCRIPTION
<i>JobID</i> ?	string	@ <i>JobID</i> of the JDF node whose status is being queried. The @ <i>JobID</i> SHALL be unique within the workflow. If not specified, list all known jobs.
<i>JobPartID</i> ?	string	@ <i>JobPartID</i> of the JDF node whose status is being queried.
<i>QueueEntryID</i> ? New in JDF 1.2	string	@ <i>QueueEntryID</i> of the job that is being queried. If @ <i>QueueEntryID</i> is specified, @ <i>JobID</i> , @ <i>JobPartID</i> and Part are ignored. If none of @ <i>JobID</i> , @ <i>JobPartID</i> , Part or @ <i>QueueEntryID</i> are specified, StatusQuParams applies to all jobs.
<i>QueueInfo</i> ? Deprecated in JDF 1.6	boolean	If "true", a Queue element is requested to be provided. This is analogous to a QueueStatus query message. Deprecation note: In JDF 1.6 and beyond, use a QueueStatus message.
Part * New in JDF 1.2	element	Part elements that describe the partition of the job whose status is queried. For details on node partitions, see ▶ Section 4.3.2 Partial processing of nodes with Partitioned resources.

5.55.3 DeviceInfo

The response message returns a **DeviceInfo** element for the queried device.

Table 5.103: DeviceInfo Element (Sheet 1 of 2)

NAME	DATA TYPE	DESCRIPTION
<i>CounterUnit</i> ?	string	The unit of the @ <i>ProductionCounter</i> , the @ <i>TotalProductionCounter</i> and numerator unit of @ <i>Speed</i> . The default unit is the default unit defined by JDF for the output resource of the node executed by the device. For example, in case of a sheet-fed printer, it is the number of sheets; in case of a web printer, it is the length of printed web in meters. Values include those from: ▶ Units.
<i>DeviceCondition</i> ? New in JDF 1.2	enumeration	The general condition of a device. Allowed values are: OK – The device is in working condition. NeedsAttention – The device is still in working condition but requires attention. Failure – The device is not in working condition. OffLine – The device is off line and its condition is unknown.
<i>DeviceID</i> ? New in JDF 1.3	string	@ <i>DeviceID</i> of the Device that this DeviceInfo describes. @ <i>DeviceID</i> SHALL match Device / <i>DeviceID</i> if Device is specified in this DeviceInfo .
<i>DeviceStatus</i>	enumeration	The status of a device. Allowed values are: Unknown – No device is known or the device cannot provide a @ <i>DeviceStatus</i> . Idle – No job is being processed and the device is accepting new jobs. Down – No job is being processed and the device currently cannot execute a job. The device might be broken, switched off, etc. Setup – The device is currently being set up. This state is allowed to occur also during the execution of a job. Running – The device is currently executing a job. Cleanup – The device is currently being cleaned. This state is allowed to occur also during the execution of a job. Stopped – The device has been stopped, probably temporarily. This status indicates some kind of break, including a pause, maintenance or a break-down, as long as execution has not been aborted.
<i>HourCounter</i> ?	duration	The total integrated time (life time) of device operation in hours.

Table 5.103: DeviceInfo Element (Sheet 2 of 2)

NAME	DATA TYPE	DESCRIPTION
<i>IdleStartTime</i> ? New in JDF 1.4	dateTime	Specifies the beginning of the last phase with no JobPhase entries. A device is idle when no active jobs are being processed. Multiple phases with different status values and no active job phases may be specified, for instance a maintenance phase followed by an idle phase. @IdleStartTime SHALL not be specified if JobPhase elements are present in the DeviceInfo or @DeviceStatus != "Idle", "Down" or "Stopped".
<i>PowerOnTime</i> ?	dateTime	Date and time when the device was switched on.
<i>ProductionCounter</i> ?	double	The current machine production counter. This counter can be reset manually. Typically, it starts counting at power-on time. The reset of this counter MAY be signaled by a Notification [@Class ="Event", @Type ="CounterReset"] message, see ▶ Appendix A.4.14.2 Notification Details.
<i>Speed</i> ?	double	@Speed specifies the current machine speed. @Speed SHALL be defined in the same units as @CounterUnit per hour.
<i>StatusDetails</i> ?	string	String that defines the device state more specifically. Values include those from: ▶ Status Details.
<i>TotalProductionCounter</i> ?	double	The current total machine production counter since the machine was produced.
Activity * New in JDF 1.5	element	Device and operator activities that are related to the device and are unrelated to a specific job.
Device ?	element	A Device resource that describes details of the device. The data type of Device is resource element. See ▶ Section 3.10.1 ResourceElement – Subelement of a Resource.
Employee *	element	Employee resources that describe which employees are currently working at the device. The data type of Employee is resource element. See ▶ Section 3.10.1 ResourceElement – Subelement of a Resource.
JobPhase *	element	Each JobPhase SHALL describe the actual status of a job in the device. All jobs that are active on the device SHALL be specified. Supplying no JobPhase specifies that no job is currently active on the device. Active jobs have JDF/@Activation ="Active", "TestRun" or "TestRunAndGo" and JDF/@Status ="TestRunInProgress", "Setup", "InProgress", "Cleanup" or "Stopped". Multiple JobPhase elements specify that multiple job phases are active simultaneously on the device. For details on using JobPhase elements, see ▶ Table 5.104 JobPhase Element.
ModuleStatus *	element	Status of individual modules that are in use independent of a job. ModuleStatus SHALL not be specified for modules that are specified in JobPhase/ModuleStatus . For details on using ModuleStatus elements, see ▶ Table 5.105 ModuleStatus Element.

5.55.4 JobPhase

A **Status** response message MAY provide **JobPhase** elements. The **JobPhase** element represents the actual state of a job. The **JobPhase** element is an analogue to the **PhaseTime** audit element described in ▶ Section 3.11.4.6 PhaseTime. The main difference between a **JobPhase** element and a **PhaseTime** audit element is that a **JobPhase** message element reflects a snapshot of the current job status whereas the **PhaseTime** audit element reflects a time span bordered by two (sub-) status transitions.

For exact information about the job phase, a **JobPhase** element MAY include a URL reference to a copy of the current state of the job described as **JDF**. If **Part** elements are specified, all attributes in **JobPhase** apply only to the specified parts. If an actual **JDF** is not supported by the controller, the same rules apply for the **Status** response message as those which apply for the **Resource** response message.

Table 5.104: JobPhase Element (Sheet 1 of 3)

NAME	DATA TYPE	DESCRIPTION
<i>Activation</i> ? New in JDF 1.1	enumeration	The activation of the JDF node. Allowed value is from: ▶ Activation.

Table 5.104: JobPhase Element (Sheet 2 of 3)

NAME	DATA TYPE	DESCRIPTION
<i>Amount</i> ?	double	Sum of actual <i>@Amount</i> that the node defined in this <i>JobPhase</i> produced since <i>@StartTime</i> . If <i>@Waste</i> is also specified, the value SHALL be without waste. The unit MAY be specified in the <i>@CounterUnit</i> attribute of the parent element <i>DevicelInfo</i> .
<i>DeadLine</i> ?	enumeration	Scheduling state of the job. Allowed values are: <i>InTime</i> – The job or job part will probably not miss the deadline. <i>Late</i> – The job or job part will miss the deadline. <i>Warning</i> – The job or job part could miss the deadline. Note: For more details on scheduling, see <i>NodeInfo</i> .
<i>JobID</i> ?	string	<i>@JobID</i> of the JDF node that is executing.
<i>JobPartID</i> ?	string	<i>@JobPartID</i> of the JDF node that is executing.
<i>PercentCompleted</i> ?	double	Node processing progress in percent (%) completed.
<i>PhaseAmount</i> ? New in JDF 1.2	double	Actual amount that the node defined in this <i>JobPhase</i> produced during this <i>JobPhase</i> . If <i>@PhaseWaste</i> is also specified, the value is without waste. The unit is specified in the <i>@CounterUnit</i> attribute of the parent element <i>DevicelInfo</i> .
<i>PhaseStartTime</i> ? New in JDF 1.2	dateTime	Time that this <i>JobPhase</i> started.
<i>PhaseWaste</i> ? New in JDF 1.2	double	Actual amount of waste that the node defined in this <i>JobPhase</i> produced during this <i>JobPhase</i> . The unit is specified in the <i>@CounterUnit</i> attribute of the parent element <i>DevicelInfo</i> .
<i>QueueEntryID</i> ?	string	If the job was submitted to a <i>Queue</i> and the <i>@QueueEntryID</i> is known, this attribute SHOULD be provided.
<i>RestTime</i> ? New in JDF 1.1	duration	Estimated duration of time to finishing processing this node.
<i>SpawnID</i> ? New in JDF 1.5	NMTOKEN	<i>@SpawnID</i> allows distinguishing multiple spawned jobs with the same <i>@JobID</i> .
<i>Speed</i> ?	double	The current job speed. <i>@Speed</i> is defined in the same units as <i>@ProductionCounter</i> / hour. Defaults to the speed specified in the <i>DevicelInfo</i> element.
<i>StartTime</i> ? New in JDF 1.1	dateTime	Time when execution of the node that is described by this <i>JobPhase</i> has been started, defined by the transition of <i>JDF/@Status</i> from "Waiting" or "Ready" to any active value.
<i>Status</i>	enumeration	The status of the JDF node. Allowed value is from: ▶ Status.
<i>StatusDetails</i> ?	string	String that defines the job state more specifically. Values include those from: ▶ Status Details.
<i>TotalAmount</i> ? New in JDF 1.1	double	Planned amount that will be produced when this job phase is 100% completed. The unit is specified in the <i>@CounterUnit</i> attribute of the parent element <i>DevicelInfo</i> .
<i>URL</i> ? New in JDF 1.4	URL	URL of a copy of the complete JDF that represents a snapshot of the job that is currently being processed. The JDF is for reference only and SHALL not be merged with the main JDF of the job using spawning and merging methods. <i>JDF/@Activation</i> SHOULD be set to "Informative" in this JDF element. The URL SHOULD reference a MIME part using a "cid" URL scheme.

Table 5.104: JobPhase Element (Sheet 3 of 3)

NAME	DATA TYPE	DESCRIPTION
<i>Waste</i> ? New in JDF 1.1	double	Total <i>@Amount</i> of waste that the node defined in this <i>JobPhase</i> produced since <i>@StartTime</i> . The unit MAY be specified in the <i>@CounterUnit</i> attribute of the parent element <i>DeviceInfo</i> .
<i>Activity</i> * New in JDF 1.5	element	Device and operator activities that are related to a specific job or job phase.
<i>CostCenter</i> ?	element	The cost center that the job is currently being charged to. Defaults to the cost center specified in the <i>DeviceInfo</i> element.
<i>GangSource</i> * New in JDF 1.6	element	If present, each <i>GangSource</i> SHALL represent the source jobs that are being processed as a gang job by this <i>QueueEntry</i> .
<i>JDF</i> ? Deprecated in JDF 1.4	element	Complete <i>JDF</i> node that represents a snapshot of the job that is currently being processed. This element is for reference only and SHALL NOT be merged with the main <i>JDF</i> of the job using spawning and merging methods. <i>JDF/@Activation</i> SHALL be set to "Informative" in this <i>JDF</i> element. Deprecation note: Starting with <i>JDF</i> 1.4, <i>JDF</i> has been replaced by <i>@URL</i> . This avoids clashes of identical <i>@ID</i> attributes when multiple <i>JobPhase</i> elements from the same <i>JDF</i> are specified.
<i>MISDetails</i> ? New in JDF 1.2	element	Definition of how the costs for this <i>JobPhase</i> are to be charged.
<i>ModuleStatus</i> * New in JDF 1.3	element	Status of individual modules that are used to execute this <i>JobPhase</i> . <i>ModuleStatus</i> SHALL NOT be specified for modules that are specified in <i>DeviceInfo/ModuleStatus</i> . For details on using <i>ModuleStatus</i> elements, see ▶ Table 5.105 ModuleStatus Element.
<i>Part</i> * Modified in JDF 1.1	element	Describes which parts of a job are currently being processed. For details on node partitions, see ▶ Section 4.3.2 Partial processing of nodes with Partitioned resources.

5.55.5 ModuleStatus

The *ModuleStatus* element restricts the scope of a *JobPhase* or *DeviceInfo* element to apply only to the device modules that are selected by the list of *ModuleStatus* elements. The *ModuleStatus* element is similar to the *ModulePhase* element of the *PhaseTime* audit element (see ▶ Table 3.36 ModulePhase Element). *ModulePhase/@DeviceID* attribute is not specified because it is already uniquely identified in *DeviceInfo/@DeviceID*. The *ModuleStatus* element is described in the following table.

Table 5.105: ModuleStatus Element (Sheet 1 of 2)

NAME	DATA TYPE	DESCRIPTION
<i>CombinedProcessIndex</i> ? New in JDF 1.3	IntegerList	<i>@CombinedProcessIndex</i> attribute specifies the indices of individual processes in the <i>@Types</i> attribute to which a <i>ModuleStatus</i> that describes a combined process node or process group node belongs. Multiple entries in <i>@CombinedProcessIndex</i> specify that the module specified by <i>ModuleStatus</i> is executing the respective multiple processes in the combined process node.
<i>DeviceStatus</i> ?	enumeration	Status of the module. Allowed values are: <i>Unknown</i> – The module status is unknown. <i>Idle</i> – The module is not used. An example is a color print module that is inactive during a black-and-white print. <i>Down</i> – The module cannot be used. It might be broken, switched off etc. <i>Setup</i> – The module is currently being set up. <i>Running</i> – The module is currently executing. <i>Cleanup</i> – The module is currently being cleaned. <i>Stopped</i> – The module has been stopped, but running might be resumed later. This status can indicate any kind of break, including a pause, maintenance or a breakdown, as long as running can be easily resumed.

Table 5.105: *ModuleStatus Element (Sheet 2 of 2)*

NAME	DATA TYPE	DESCRIPTION
<i>ModuleID</i> ? New in JDF 1.3	string	@ <i>ModuleID</i> of the module that <i>ModuleStatus</i> refers to. If not specified, the module is specified in @ <i>ModuleIndex</i> . At least one of @ <i>ModuleID</i> or @ <i>ModuleIndex</i> SHALL be specified.
<i>ModuleIndex</i> ? Modified in JDF 1.3	IntegerRangeList	The 0-based indices of the module or modules. If multiple module types are available on one machine, indices SHALL also be unique. @ <i>ModuleIndex</i> is unique within the machine.
<i>ModuleType</i> ? Modified in JDF 1.5	NMTOKEN	Module description Values include those from: ▶ Module Types. Note: The allowed values depend on the type of device. Each type of device has a separate table of values. Modification note: Starting with JDF 1.5, @ <i>ModuleType</i> is optional.
<i>StatusDetails</i> ?	string	Description of the module status phase that provides details beyond the enumerative values given by the @ <i>DeviceStatus</i> attribute. Values include those from: ▶ Status Details.
<i>Employee</i> * Deprecated in JDF 1.5	element	<i>Employee</i> resource(s) that represent the employee(s) that are working at this module (the module is specified by the attributes @ <i>ModuleIndex</i> and @ <i>ModuleType</i>). The data type of <i>Employee</i> is ResourceElement. See ▶ Section 3.10.1 ResourceElement – Subelement of a Resource.

Example 5.35: Status Response to Query

The following is an example of a *Response* message to a *Status* query message. The device in this example holds one job and executes another job that is currently printed duplex (each side) on four-color modules for the front and three-color modules for the back, with one idle:

```
<Response ID="M1" Type="Status" refID="Q1" xsi:type="ResponseStatus">
  <DeviceInfo DeviceStatus="Running" StatusDetails="Waste">
    <JobPhase Amount="2560" DeadLine="InTime" JobID="678"
      JobPartID="01" PercentCompleted="52" QueueEntryID="Job-05"
      Status="InProgress" StatusDetails="Waste"/>
    <JobPhase Amount="0" DeadLine="Warning" JobID="679" JobPartID="01"
      PercentCompleted="0" QueueEntryID="Job-06" Status="Ready"/>
    <ModuleStatus DeviceStatus="Running" ModuleIndex="0 ~ 3 6 ~ 8" ModuleType="PrintModule"/>
    <ModuleStatus DeviceStatus="Idle" ModuleIndex="4" ModuleType="PrintModule"/>
    <ModuleStatus DeviceStatus="Running" ModuleIndex="5" ModuleType="PerfectingModule"/>
  </DeviceInfo>
</Response>
```

5.56 StopPersistentChannel

The *StopPersistentChannel* command message unregisters a listening controller from a persistent channel. No more messages are sent to the controller once the command has been issued. A certain subset of signals MAY be addressed to be unsubscribed by specifying a *StopPersChParams* element.

Table 5.106: *StopPersistentChannel Message*

OBJECT TYPE	ELEMENT NAME	DESCRIPTION
<i>CommandTypeObj</i>	<i>StopPersChParams</i>	Specifies the persistent channel and the message types to be unsubscribed.
<i>ResponseTypeObj</i> *	<i>SubscriptionInfo</i>	One <i>SubscriptionInfo</i> element SHALL be returned for every persistent channel that was removed.

5.56.1 StopPersChParams

StopPersChParams provides a filter which selects persistent channels that SHALL be unregistered.

Table 5.107: StopPersChParams Element

NAME	DATA TYPE	DESCRIPTION
ChannelID ?	NMTOKEN	@ ChannelID of the persistent channel to be deleted. If the channel has been created with a Query message, the @ ChannelID specifies the @ ID of the Query message (identical to the @ refID of the Response message).
MessageType ?	NMTOKEN	Only messages with a matching message type are suppressed. Default value is: all message types Values include those from: ▶ Table 5.14 List of JMF Messages.
DeviceID ?	NMTOKEN	Only messages from devices or controllers with a matching @ DeviceID attribute are suppressed.
JobID ? Deprecated in JDF 1.5	string	Only messages with a matching @ JobID attribute are suppressed. Deprecation note: Job specific subscriptions are discouraged.
JobPartID ? Deprecated in JDF 1.5	string	Only messages with a matching @ JobPartID attribute are suppressed. Deprecation note: Job specific subscriptions are discouraged.
QueueEntryID ? New in JDF 1.2 Deprecated in JDF 1.5	string	@ QueueEntryID of the job whose messages are queried/subscribed. If @ QueueEntryID is specified, @ JobID , @ JobPartID and Part are ignored. If none of @ JobID , @ JobPartID , Part or @ QueueEntryID are specified, StopPersChParams applies to all jobs that will be processed by the receiver. Deprecation note: Job specific subscriptions are discouraged.
URL	URL	URL of the receiving controller. This SHALL be identical to the @ URL that was used to create the persistent channel. If no @ ChannelID is specified, all persistent channels to this @ URL are deleted.
Part * New in JDF 1.2 Deprecated in JDF 1.5	element	Part elements that describe the partition of the job whose messages are suppressed. For details on node partitions, see ▶ Section 4.3.2 Partial processing of nodes with Partitioned resources. Deprecation note: Job specific subscriptions are discouraged.

5.57 SubmissionMethods

The [SubmissionMethods](#) message returns information about the [QueueEntry](#) submission and return formats that are supported by a device or controller. Thus, it can be used to determine the details of how a [SubmitQueueEntry](#) message can be sent to a device, or the details of a [ReturnQueueEntry](#) message that will be returned by the device.

Table 5.108: SubmissionMethods Message

OBJECT TYPE	ELEMENT NAME	DESCRIPTION
QueryTypeObj	—	—
ResponseTypeObj	SubmissionMethods ?	Describes the submission methods supported by the queue.

5.57.1 SubmissionMethods

The response message element MAY contain multiple attributes, as defined below. If an attribute is not specified, the corresponding submission method is not supported.

Table 5.109: SubmissionMethods Element (Sheet 1 of 2)

NAME	DATA TYPE	DESCRIPTION
File ? Deprecated in JDF 1.2	boolean	Can retrieve a JDF from a file specified in the URL In JDF 1.2 and beyond, include "file" in @ URLSchemes .
HotFolder ? Deprecated in JDF 1.4	URL	URL specification of a hot folder location. Deprecation note: Starting with JDF 1.4, use the KnownDevices response: / JMF/Response/DeviceInfo/Device/@JDFInputURL

Table 5.109: SubmissionMethods Element (Sheet 2 of 2)

NAME	DATA TYPE	DESCRIPTION
HttpGet ? Deprecated in JDF 1.2	boolean	Can retrieve a JDF via HTTP get commands. In JDF 1.2 and beyond, include "http" in @URLSchemes.
MIME ? Deprecated in JDF 1.2	boolean	Accepts MIME Multipart/Related submission messages via a message post. In JDF 1.2 and beyond, use @Packaging="MIME".
Packaging ? New in JDF 1.2 Modified in JDF 1.4	enumerations	List of packaging methods supported. Default behavior: The controller does not support receiving packaged messages and SHALL retrieve JDF files using a URL with a scheme other than "cid". Allowed values are: MIME – Accepts MIME Multipart/Related packaging of JMF , JDF and digital assets. None – no form of packaging is supported. New in JDF 1.4
URLSchemes ? New in JDF 1.2	NMTOKENS	List of schemes supported for retrieving JDF files. If not specified, the controller does not support retrieving JDF files from remote URLs. Values include: file – The file scheme according to ▶[RFC1738] and ▶[RFC3986]. ftp – FTP (File Transfer Protocol) http – HTTP (Hypertext Transport Protocol) https – HTTPS (Hypertext Transport Protocol — Secure)

Example 5.36: SubmissionMethods Response

The following is an example of a response message to a [SubmissionMethods](#) query message:

```
<Response ID="M1" Type="SubmissionMethods" refID="Q1" xsi:type="ResponseSubmissionMethods">
  <SubmissionMethods HotFolder="file://MyDevice/HotFolder"
    Packaging="MIME" URLSchemes="http file ftp"/>
</Response>
```

5.58 SubmitQueueEntry

[SubmitQueueEntry](#) submits a job to a queue of a device or controller. [QueueSubmissionParams](#) provides the parameters associated with the submission.

5.58.1 QueueSubmissionParams

Table 5.110: SubmitQueueEntry Message

OBJECT TYPE	ELEMENT NAME	DESCRIPTION
<i>CommandTypeObj</i> Modified in JDF 1.5	<i>QueueFilter</i> ? New in JDF 1.2 Deprecated in JDF 1.5	Defines a filter for the returned <i>Queue</i> element in the <i>SubmitQueueEntry</i> message.
	<i>QueueSubmissionParams</i>	Defines the job submission.
<i>ResponseTypeObj</i> Modified in JDF 1.5	<i>Queue</i> Deprecated in JDF 1.5	Describes the state of the queue after the command has been executed.
	<i>QueueEntry</i> ? Modified in JDF 1.2	Provides the queue entry of the submitted job. <i>QueueEntry</i> SHALL be specified if the submission was successful and SHALL be omitted in case the submission was rejected.

Definition of the *QueueEntry* elements, see ▶ Section 5.14 Elements for Queues.

The job submission can contain queue-ordering attributes equivalent to those used by the *SetQueueEntryPriority* and *SetQueueEntryPosition* messages. The *@URL* attribute specifies the location where the *JDF* file to be submitted can be retrieved by the queue controller. The location type in the *@URL* attribute (such as "file", "http" or "cid") defines the submission method. *@ReturnURL* or *@ReturnJMF* MAY specify the location where the modified *JDF* SHALL be sent after the job is completed or aborted.

The *@URL* attribute specifies the location where the queue controller can retrieve the *JDF* file to be submitted.

Table 5.111: QueueSubmissionParams Element (Sheet 1 of 2)

NAME	DATA TYPE	DESCRIPTION
<i>Activation</i> ?	enumeration	Activation of the submitted <i>JDF</i> . Allowed value is from: ▶ Activation.
<i>GangName</i> ? New in JDF 1.3	NMTOKEN	Name of the gang for the job. If <i>@GangName</i> is specified, the <i>QueueEntry</i> SHOULD be executed along with other <i>QueueEntry</i> elements that share a common value of <i>@GangName</i> . If <i>@GangName</i> is not known, the receiving device MAY either return an error 131 or create the gang with <i>@GangName</i> on the fly.
<i>GangPolicy</i> ? New in JDF 1.3	enumeration	Ganging policy for the <i>QueueEntry</i> . Allowed value is from: ▶ GangPolicy.
<i>Hold</i> = "false"	boolean	If "true", the entry is submitted as for <i>QueueEntry</i> / <i>@Status</i> ="Held". If a <i>QueueEntry</i> is submitted with <i>@Hold</i> ="true" and <i>@GangPolicy</i> is other than "NoGang", the <i>QueueEntry</i> retains its respective gang data but does not influence execution of other jobs that are in the gang.
<i>NextQueueEntryID</i> ?	string	ID of the queue entry that SHALL be positioned directly behind the entry. At most one of <i>@NextQueueEntryID</i> , <i>@PrevQueueEntryID</i> or <i>@Priority</i> SHALL be specified.
<i>PrevQueueEntryID</i> ?	string	ID of the queue entry that SHALL be positioned directly in front of the entry. At most one of <i>@NextQueueEntryID</i> , <i>@PrevQueueEntryID</i> or <i>@Priority</i> SHALL be specified.

Table 5.111: QueueSubmissionParams Element (Sheet 2 of 2)

NAME	DATA TYPE	DESCRIPTION
<i>Priority</i> = "1"	integer	Number from 0 to 100, where "0" is the lowest priority and "100" is the maximum priority. Exactly one of <code>@NextQueueEntryID</code> , <code>@PrevQueueEntryID</code> or <code>@Priority</code> SHALL be specified. Note that <code>QueueSubmissionParams/@Priority</code> is not the same as <code>NodeInfo/@Priority</code> . <code>QueueSubmissionParams/@Priority</code> specifies the priority in the context of the device queue whereas <code>NodeInfo/@Priority</code> specifies the priority of the task in general. <code>QueueSubmissionParams/@Priority</code> MAY be modified due to additional scheduling information (e.g., <code>NodeInfo/@FirstStart</code>). The priority from <code>QueueSubmissionParams/@Priority</code> and <code>QueueEntryPriParams/@Priority</code> takes precedence over <code>NodeInfo/@JobPriority</code> .
<i>refID</i> ? New in JDF 1.2	NMTOKEN	Copy of the <code>@ID</code> attribute of the initiating <code>RequestQueueEntry</code> message.
<i>ReturnJMF</i> ? New in JDF 1.2	URL	Address of a JMF queue where a <code>ReturnQueueEntry</code> message SHALL be sent when the <code>QueueEntry</code> is completed or aborted. Note that the <code>@ReturnJMF</code> queue SHOULD be queried with a <code>SubmissionMethods</code> query message to determine whether MIME Multipart/Related is supported by the return queue. <code>@ReturnJMF</code> SHALL NOT be specified if <code>@ReturnURL</code> is present.
<i>ReturnURL</i> ? Modified in JDF 1.2	URL	URL where the JDF file SHALL be written when the <code>QueueEntry</code> is completed or aborted. A controller SHALL write only a JDF document to the URL and SHALL NOT write a MIME Multipart package to the URL. If <code>@ReturnURL</code> is specified with the "file" scheme, <code>@ReturnURL</code> SHALL specify an individual file. <code>@ReturnURL</code> SHALL take precedence when <code>NodeInfo/@TargetRoute</code> is specified in the submitted JDF . Note: A controller SHALL NOT return a JDF file or MIME Multipart/Related file by performing a <code>SubmitQueueEntry</code> or <code>ReturnQueueEntry</code> to the <code>@ReturnURL</code> URL. The controller specified by <code>@ReturnURL</code> SHALL NOT accept JMF messages. See instead <code>@ReturnJMF</code> . <code>@ReturnURL</code> SHALL NOT be specified if <code>@ReturnJMF</code> is present.
<i>URL</i> Modified in JDF 1.2	URL	Location of the JDF to be submitted. In the case of MIME Multipart/Related, the URL MAY have a "cid" scheme.
<i>WatchURL</i> ? Modified in JDF 1.2 Deprecated in JDF 1.5	URL	URL of the controller that SHALL be notified when the status of the <code>QueueEntry</code> or the underlying job changes.
<i>Disposition</i> ? New in JDF 1.2	element	Defines how long the <code>QueueEntry</code> SHOULD be retained in the queue. If not specified, the <code>QueueEntry</code> MAY be removed from the queue immediately after process completion of the <code>QueueEntry</code> .

Example 5.37: SubmitQueueEntry Command with "file" Scheme

If the URL has a "file" scheme, the device retrieves the file at the location specified in the `@URL` attribute. The following example declares a file on the network.

```
<Command ID="M1" Type="SubmitQueueEntry" xsi:type="CommandSubmitQueueEntry">
  <QueueSubmissionParams URL="File://MyNetworkShare/AnyDirectory/job1.jdf"/>
</Command>
```

Example 5.38: SubmitQueueEntry Command with "http" Scheme

In this example, the queue controller retrieves the file with a standard HTTP `get` command from a host that MAY be remote. The job delivered as a response to the HTTP `get` command MAY be a MIME Multipart/Related entity. The HTTP server MAY retrieve a file or it MAY generate the response dynamically with a CGI script or other such tool.

```
<Command ID="M2" Type="SubmitQueueEntry" xsi:type="CommandSubmitQueueEntry">
  <QueueSubmissionParams URL="http://JobServer.JDF.COM?job1"/>
</Command>
```

JDF Package Submission

If a controller is capable of decoding MIME, it is legal to submit a MIME Multipart/Related message. See ▶ Section 11.3 JDF Packaging for details of MIME Multipart/Related packaging.

5.59 SuspendQueueEntry

New in JDF 1.2

The entry specified by [QueueEntryDef](#) is suspended if its `@Status` is "Running". Its `@Status` is set to "Suspended". Whether other queue entries can be run while the queue entry remains suspended depends on implementation. The [SuspendQueueEntry](#) command message has no effect on jobs with a `@Status` other than "Running". For details, see ▶ Table 5.20 Status Transitions for QueueEntry Handling Messages.

Table 5.112: SuspendQueueEntry Message

OBJECT TYPE	ELEMENT NAME	DESCRIPTION
CommandTypeObj Modified in JDF 1.5	QueueEntryDef Deprecated in JDF 1.5	Defines the queue entry.
	QueueFilter ? Deprecated in JDF 1.5	Defines a filter for the returned Queue element in the SuspendQueueEntry message.
	SuspendQueueEntryParams ? New in JDF 1.5	
ResponseTypeObj Modified in JDF 1.5	Queue Deprecated in JDF 1.5	Describes the state of the queue after the command has been executed. See ▶ Section 5.14 Elements for Queues for the definition of the elements listed above. The entry specified by QueueEntryDef remains in the queue, but moves into the "Suspended" state.

5.59.1 SuspendQueueEntryParams

New in JDF 1.5

Table 5.113: SuspendQueueEntryParams Element

NAME	DATA TYPE	DESCRIPTION
QueueFilter ?	element	This QueueFilter selects the QueueEntry elements to apply to

5.60 Track

Deprecated in JDF 1.5

The [Track](#) message has been deprecated in JDF 1.5.

5.61 UpdateJDF

New in JDF 1.3

This **JMF** is used to synchronize a **JDF** node that has been submitted by a controller to a device.

5.61.1 UpdateJDF Command

The [UpdateJDF Command](#) will be sent from a controller (e.g., an MIS) to a device (e.g., a workflow system) which received the original job. The changes SHALL be applied to processes that have not started yet. If the MIS tries to do update a running job, the controller or device MAY return an error 107.

Any *JDF/@Type* value MAY be added to the original **JDF** with this message.

Figure 5-9: Without UpdateJDF message



The **JDF** submitted to the controller contains the two processes P1 and P2. They are linked using **Resource** R1 and the **ResourceLink** elements L1 and L2

Figure 5-10: With UpdateJDF message

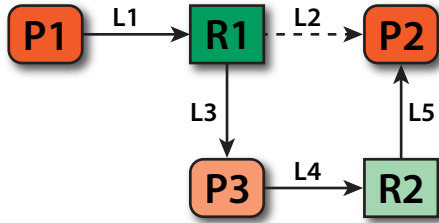

The **Resource** R1 is first processed by process P3 whose output resource R2 is then consumed by process P2, which has been waiting for R2 to become "Available".

The **UpdateJDF** message contains the new process P3, the resource R2 and the three new **ResourceLink** elements L3, L4 and L5. The **ResourceLink** L2 SHALL be removed from the **JDF**.

Table 5.114: UpdateJDF Command

OBJECT TYPE	ELEMENT NAME	DESCRIPTION
<i>CommandTypeObj</i>	<i>UpdateJDFCmdParams</i> ?	Defines the details of the UpdateJDF message.
<i>ResponseTypeObj</i>	-	-

5.61.2 UpdateJDF Signal

New in JDF 1.4

The **UpdateJDF Signal** will be sent from the device to a controller. It notifies the controller about modifications that have occurred on the device.

Table 5.115: UpdateJDF Signal

OBJECT TYPE	ELEMENT NAME	DESCRIPTION
<i>QueryTypeObj</i>	<i>UpdateJDFCmdParams</i> ?	Defines the details of the UpdateJDF message.
<i>ResponseTypeObj</i>	-	-

5.61.2.1 UpdateJDFCmdParams

The **UpdateJDFCmdParams** specifies a **JDF** node, new **Resource** elements and new **ResourceLink** elements to add to existing nodes.

Table 5.116: UpdateJDFCmdParams Element (Sheet 1 of 2)

NAME	DATA TYPE	DESCRIPTION
<i>ParentJobID</i>	string	@ <i>JobID</i> of the node in which the new node SHALL be inserted.
<i>ParentJobPartID</i>	string	@ <i>JobPartID</i> of the node in which the new node SHALL be inserted.
CreateLink *	element	New ResourceLink elements to be added to the previously submitted JDF nodes.
CreateResource *	element	Newly created resources to be added to previously submitted JDF nodes. The resources are used to link the new node to existing nodes. Resources that are linked only internally within the new node SHOULD be in the new node and SHOULD NOT be placed in a another ResourcePool using CreateResource elements.

Table 5.116: UpdateJDFCmdParams Element (Sheet 2 of 2)

NAME	DATA TYPE	DESCRIPTION
JDF	element	The new JDF node to become a child of the parent node. It is an error (204 - Cannot create node) to specify a JDF with a combination of @JobID and @JobPartID that matches an existing JDF node in the JDF ticket in which the parent node resides.
MoveResource *	element	Specifies resources in previously submitted JDF nodes that are to be moved to another ResourcePool so that they are accessible for all new JDF nodes that link to the resources. Note: MoveResource does not create new partitions in existing resources.
RemoveLink *	element	ResourceLink elements in the previously submitted job that are no longer in use and are to be removed.

5.61.2.2 CreateLink

Table 5.117: CreateLink Element

NAME	DATA TYPE	DESCRIPTION
JobID	string	@JobID of the node in which the new ResourceLink is inserted.
JobPartID	string	@JobPartID of the node in which the new ResourceLink is inserted.
ResourceLink +	element	The new ResourceLink elements which link the new node to the existing nodes. If the node already has a link to this resource with a different Part element, the Part elements that are specified in this ResourceLink SHALL be added to the existing ResourceLink .

5.61.2.3 CreateResource

Table 5.118: CreateResource Element

NAME	DATA TYPE	DESCRIPTION
JobID	string	@JobID of the node in which the new Resources are to be inserted.
JobPartID	string	@JobPartID of the node in which the new Resources are to be inserted.
Resource +	element	The new Resource elements. In general, these are created to link the new node to existing nodes. The data type and @Class of Resource is derived from the abstract resource. See ▶ Section 3.8.3 Abstract Resource.

5.61.2.4 MoveResource

Table 5.119: MoveResource Element

NAME	DATA TYPE	DESCRIPTION
JobID	string	@JobID of the node to which the new Resource SHALL be moved.
JobPartID	string	@JobPartID of the node in which the new Resource SHALL be moved.
ResourceID	NMTOKEN	Resource/@ID of the Resource that is moved. Note: If the Resource has been spawned, an error MAY be reported back.

5.61.2.5 RemoveLink

Table 5.120: RemoveLink Element

NAME	DATA TYPE	DESCRIPTION
<i>JobID</i>	string	@ <i>JobID</i> of the node from which the ResourceLink elements are to be removed.
<i>JobPartID</i>	string	@ <i>JobPartID</i> of the node from which the ResourceLink elements are to be removed.
ResourceLink +	element	The ResourceLink elements to be removed. Note: If this ResourceLink contains fewer Part elements than the corresponding ResourceLink in the JDF , only the Part elements specified in this ResourceLink are to be removed.

Note: This message might not work:

- if one of the Resources or Links have references to a Pipe.
- if the Controller has submitted parts of the job to a second controller or a device.

The **JDF** after executing the message is valid

- on a Job which is waiting.
- if all Nodes, to which the new Node is linked are waiting.
- if the link to a running Node is not using a pipe.

Example 5.39: UpdateJDF Command

```
<Command ID="ID1" Type="UpdateJDF" xsi:type="CommandUpdateJDF">
  <UpdateJDFCmdParams ParentJobID="ID100" ParentJobPartID="ID112">
    <CreateLink JobID="ID100" JobPartID="ID111">
      <MediaLink Usage="Input" rRef="link001111"/>
    </CreateLink>
    <CreateResource JobID="100" JobPartID="110">
      <Component rRef="link001112"/>
    </CreateResource>
    <RemoveLink JobID="100" JobPartID="111">
      <MediaLink Usage="Input" rRef="link001113"/>
    </RemoveLink>
    <MoveResource JobID="100" JobPartID="101" ResourceID="link000004"/>
    <JDF JobPartID="200" Type="Cutting">
      <AuditPool>
        <Created AgentName="MIS" AgentVersion="1.0" TimeStamp="2005-06-02T09:01:45+01:00"/>
      </AuditPool>
      <ResourcePool>
        <Component Class="Quantity" ComponentType="Sheet"
          ID="link000002" Status="Available"/>
        <CuttingParams Class="Parameter" ID="link000007" Status="Available"/>
      </ResourcePool>
      <ResourceLinkPool>
        <ComponentLink Usage="Output" rRef="link000002"/>
        <CuttingParamsLink Usage="Input" rRef="link000007"/>
      </ResourceLinkPool>
    </JDF>
  </UpdateJDFCmdParams>
</Command>
```

5.62 WakeUp

New in JDF 1.2

The **WakeUp** command message activates a controller or device that has been in stand-by mode. All queues that belong to the device are held upon its receiving a **WakeUp** and SHALL be resumed with an explicit **ResumeQueueEntry** message.

All jobs that were running on the device at shutdown are also in a held state and SHALL be explicitly resumed with a [ResumeQueueEntry](#) message. A device SHALL use the [Status](#) message if it signals its own awakening.

Table 5.121: WakeUp Message

OBJECT TYPE	ELEMENT NAME	DESCRIPTION
CommandTypeObj	WakeUpCmdParams ?	Defines the details of the WakeUp message.
ResponseTypeObj	DeviceInfo	Describes the device status immediately after the WakeUp message has been sent. The device SHOULD also send an Acknowledge/WakeUp message after its warm up cycle has been completed if applicable.

5.62.1 WakeUpCmdParams

[WakeUpCmdParams](#) is a placeholder for future use and for extensions to the [WakeUp](#) message.

Table 5.122: WakeUpCmdParams Element

NAME	DATA TYPE	DESCRIPTION
—	—	—

6 Processes

The following chapter describes the processes that are defined in detail for JDF.

6.1 Process Template

Processes are defined by their input and output resources. All relevant resource information is provided in tables for each process. Furthermore, although they are not listed for each process, additional, OPTIONAL input resources (as defined in ▶ Table 6.1 Template for Input Resources) are valid for all processes defined in this chapter.

Note: Regarding the Templates for tables for Input Resources and Output Resources

- Italicized text describes the actual text that would be in its place in an actual process definition
- *Cardinality* in the Name column refers to a cardinality symbol, which is either empty or consists of a symbol, such as “?”. Examples described by the Name column include: “*Media**” and “*Component (Proof) ?*”. For further details, see ▶ Section 1.3.5 Specification of Cardinality.
- The text following a “Note:” in a table field gives further information about the specified table row.
- Each of the first two rows of each table represents zero or more of what it describes. Each of the remaining rows in the Input Resource Template describes an Input Resource that is OPTIONAL for any process, even though it doesn’t appear in the process’s Input Resources table.



The JDF Cookbook

Chapter 6 and following are “the list of ingredients” in the JDF “cookbook.” The following Processes and Elements are fairly exhaustive. You can choose to use only what fits your workflow.

Table 6.1: Template for Input Resources (Sheet 1 of 2)

NAME	DESCRIPTION
<i>Resource-Name</i> <i>Cardinality</i>	<i>Information about the Input Resource.</i> Note: The resource represents any input resource. If an OPTIONAL resource is not specified in a JDF instance, the JDF Consumer MAY make its own assumption regarding attributes and subelements of the resource. Specification-defined attribute defaults cannot be guaranteed.
<i>Resource-Name</i> <i>(someValue) Cardinality</i>	<i>Information about the Input Resource</i> Note: @ProcessUsage attribute of the specified resource SHALL match the “someValue” value specified in the parentheses. When a process potentially contains multiple input resources of the same type, the value of @ProcessUsage distinguishes the resources.
<i>ApprovalSuccess</i> *	Any number of <i>ApprovalSuccess</i> Resources MAY be appended to processes in order to model proofing and verification requirements. This is implied and not specified explicitly in the tables in the following section. For more information on the <i>Approval</i> process, see ▶ Section 6.2.1 Approval.
<i>ColorPool</i> ? New in JDF 1.6	<i>ColorPool</i> identifies all the colors that are used in the job. <i>ColorPool</i> may include separations that represent die lines or other auxiliary colors.
<i>CustomerInfo</i> ? New in JDF 1.3	Specifies information about the customer. Prior to JDF 1.3 <i>CustomerInfo</i> was not a resource, but rather a direct child element of the JDF node.
<i>Employee</i> *	<i>Employee</i> that is associated with processing this node.
<i>Device</i> *	<i>Device</i> that is associated with processing this node.
<i>MiscConsumable</i> * New in JDF 1.3	Generic consumable resources that are associated with processing this node.
<i>NodeInfo</i> ? New in JDF 1.3	Specifies information about the node. Prior to JDF 1.3 <i>NodeInfo</i> was not a resource, but rather a direct child element of the JDF node.

Table 6.1: Template for Input Resources (Sheet 2 of 2)

NAME	DESCRIPTION
PreflightReport * New in JDF 1.2	Any number of PreflightReport Resources MAY be appended to processes in order to convey the results of previous preflighting steps. This is implied and not specified explicitly in the tables in the following section. For more information on the Preflight process, see ▶ Section 6.3.27 Preflight.
Preview * New in JDF 1.1A Deprecated in JDF 1.4	Any number of previews MAY be associated with a process and used for display purposes. Preview / @PreviewUsage SHOULD be "ThumbNail" or "Viewable". Deprecation note: Starting with JDF 1.4, a Preview MAY be a member of any element. See ▶ Table 3.1 Any Element (generic content).
Tool * New in JDF 1.4	Miscellaneous reusable tool required for a process.
UsageCounter * New in JDF 1.3	Devices MAY use counters, called "usage counters", to track equipment utilization or work performed, such as impressions produced or documents generated.

6.2 General Processes

General processes that can take place throughout the workflow.

6.2.1 Approval

The **Approval** process can take place at various steps in a workflow. For example, a resource (e.g., a printed sheet or a finished book) is used as the input to be approved, and an **ApprovalSuccess** (given, for example, by a customer or foreman) is produced. Combining the process with any other process can be used to represent a request for a receipt. The process that follows the **Approval** process in the workflow chain will most often require the **ApprovalSuccess** as input. Resources typically have a **@Status** = "Draft" before the **Approval**. After a successful **Approval**, Resources have a **@Status** = "Available" and after an unsuccessful **Approval**, they have a **@Status** = "Rejected".

Table 6.2: Approval – Input Resources

NAME	DESCRIPTION
ApprovalParams	Details of the approval process.
Resource *	The resources to be approved. The input will most often be a resource of Class "Handling" or "Quantity". When the input resource of an Approval process is a ByteMap , it SHOULD be displayed on a viewing device.

Table 6.3: Approval – Output Resources

NAME	DESCRIPTION
ApprovalSuccess	Result of any Approval process given, for example, by a customer or foreman. Note that ApprovalSuccess Resources are only available on success.
Resource (Accepted) *	Represents the input resources that have been accepted for further processing by the Approval process as output resources. This is typically used to transfer the resource @Status of "Draft" to "Available" (see also ▶ Section 4.3.5.2 Formal Iterative processing).
Resource (Rejected) *	Represents the input resources that have been rejected for further processing by the Approval process as output resources. This can be used to define additional processing for rejected resources. Resource / @Status SHOULD be set to "Rejected".

6.2.2 Buffer

New in JDF 1.1

The **Buffer** process is used to buffer a **Resource** for a certain time period. This can be buffering of a complete resource or of a partial **Resource** (e.g., in a pipe). The **@Amount** of the input and output of resources SHALL be equal. Waiting for printed material to dry before finishing is an example of the **Buffer** process.

Table 6.4: Buffer – Input Resources

NAME	DESCRIPTION
BufferParams	The parameters (e.g., times and locations of the Buffer process).
Resource	The Resource element to be buffered.

Table 6.5: Buffer – Output Resources

NAME	DESCRIPTION
Resource	The same Resource after buffering.

6.2.3 Combine

The **Combine** process is used to combine multiple **PhysicalResources** or logical resources (e.g., **RunList** Resources of the same content to form one resource). The sum of **@Amount** of the input and output of resources SHALL be equal. The ordering of the input **ResourceLink** elements SHALL be honored.

Table 6.6: Combine – Input Resources

NAME	DESCRIPTION
Resource +	The resources to be combined.

Table 6.7: Combine – Output Resources

NAME	DESCRIPTION
Resource	Result of combining. The resource formed as a result of the Combine process.

6.2.4 Delivery

This process can be used to describe the delivery of a **PhysicalResource** to or from a location. This delivery can be internal – meaning within the company – or to an external company or customer. The **CustomerInfo** element of the **JDF** node can also be used if the delivery is to be made to only one customer. Note that a delivery receipt can be requested by combining the **Delivery** process with an **Approval** process.

Table 6.8: Delivery – Input Resources

NAME	DESCRIPTION
DeliveryParams	Necessary information about the physical item or items to be delivered is stored here.
Resource ? Deprecated in JDF 1.2	Any resource delivered to a location. This can be a PhysicalResource or a Parameter Resource that is delivered electronically. Modification Note: In JDF 1.2 and beyond the delivered resources are defined as referents in elements of DeliveryParams/Drop/DropItem .

Table 6.9: Delivery – Output Resources

NAME	DESCRIPTION
Resource + Modified in JDF 1.2	These SHALL be PhysicalResources .

6.2.5 ManualLabor

New in JDF 1.1

This process can be used to describe any process where resources are handled manually. The **ManualLabor** process is designed to monitor any type of non-automated labor from an MIS system.

Table 6.10: ManualLabor – Input Resources

NAME	DESCRIPTION
ManualLaborParams	Details on the ManualLabor process.
Resource *	Resources that are used to create the output resource.

Table 6.11: ManualLabor – Output Resources

NAME	DESCRIPTION
Resource * Modified in JDF 1.4	The resources that were created by manual work. In general these will be Component resources, but Handling Resources MAY also be processed manually. If no output resource is specified, the ManualLabor process describes incidental work. Modification note: Starting with JDF 1.4 , multiple resources are allowed.

6.2.6 Ordering

Deprecated in JDF 1.5

6.2.7 Packing

Deprecated in JDF 1.1

6.2.8 QualityControl

New in JDF 1.2

This process defines the setup and frequency of quality controls for a process. **QualityControl** is generally performed on **Component** resources produced as intermediate or final output of a process.

Table 6.12: QualityControl – Input Resources

NAME	DESCRIPTION
QualityControlParams	Detailed definition of the QualityControl process.
Resource	The resource to be quality controlled. In general this will be a Component resource.

Table 6.13: QualityControl – Output Resources

NAME	DESCRIPTION
QualityControlResult	Results of the process, e.g. measurement statistics.
Resource	This resource describes the resource after QualityControl has been applied. Note: This resource will generally be partitioned by @Condition to track the amount of accepted and rejected resources. This Resource SHOULD reference the QualityControlResult Output resource.

6.2.9 ResourceDefinition

This process can be used to describe the interactive or automated process of defining resources such as set-up information. This process creates output resources or modifies input resources of the same type as the output resources. The **ResourceDefinition** process is designed to monitor interactive work such as creating imposition templates. It can also be used to model a hot folder process that accepts resources from outside of a **JDF** based workflow.

Table 6.14: ResourceDefinition – Input Resources (Sheet 1 of 2)

NAME	DESCRIPTION
Resource * Modified in JDF 1.1	Any type of resource. Generally these will be templates.

Table 6.14: ResourceDefinition – Input Resources (Sheet 2 of 2)

NAME	DESCRIPTION
ResourceDefinitionParams ?	Details on how to handle defaults.

Table 6.15: ResourceDefinition – Output Resources

NAME	DESCRIPTION
Resource + Modified in JDF 1.1	The same type of resource as one of the input resources.

6.2.10 Split

This process is used for splitting one physical or logical resource into multiple physical or logical resources containing the same content as the original. The sum of [@Amount](#) of the input and output of resources SHALL be equal.

Table 6.16: Split – Input Resources

NAME	DESCRIPTION
Resource	The resource to be split.

Table 6.17: Split – Output Resources

NAME	DESCRIPTION
Resource +	The resources formed as a result of splitting.

6.2.11 Verification

The **Verification** process is used to confirm that a process has been completely executed. In the case of variable data printing in which every document is unique and validated individually, database access is required. Verification in this situation can involve scanning the physical sheet and interpreting a bar code or alphanumeric characters. The decoded data can then be either recorded in a database to be later cross referenced with a verification list, or cross referenced and validated immediately in real time.

Verification differs from **QualityControl** in that **Verification** verifies the existence of a given set of resources, whereas **QualityControl** verifies that the existing resources fulfill certain quality criteria.

Table 6.18: Verification – Input Resources

NAME	DESCRIPTION
DBSchema ? Deprecated in JDF 1.5	Schema description of the cross-reference database.
DBSelection ? Deprecated in JDF 1.5	Database link that defines the database that contains cross-reference data.
FileSpec (Verification) ? New in JDF 1.5	Reference to data that contains implementation specific descriptions of the resources to be verified.
IdentificationField * Deprecated in JDF 1.5	Identifies the position and type of data for an automated, OCR-based verification process. Deprecation note: Starting with JDF 1.5, use Component/IdentificationField .
Resource ? New in JDF 1.2	The resource to be verified. The input will most often be a resource with @Class = "Quantity" (e.g., Component) or @Class = "Parameter" (e.g., RunList).
VerificationParams	Controls the verification requirements.

Table 6.19: Verification – Output Resources

NAME	DESCRIPTION
ApprovalSuccess ? New in JDF 1.5	Signature file that defines verification success.
DBSelection ? Deprecated in JDF 1.5	Database link where the verification data SHALL be recorded.
FileSpec (Accepted) ? New in JDF 1.5	Reference to data that contains implementation specific descriptions of the resources that were correctly verified.
FileSpec (Rejected) ? New in JDF 1.5	Reference to data that contains implementation specific descriptions of the resources that were NOT correctly verified.
FileSpec (Unknown) ? New in JDF 1.5	Reference to data that contains implementation specific descriptions of the resources that were scanned but are NOT in the explicit or implied list of known resources.
Resource ? New in JDF 1.2	The resource after verification. Most often the Resource will not be modified by Verification . It has been added here to allow modeling of Verification in a combined processes.

6.3 Prepress Processes

This section lists all processes that are performed prior to printing. This includes processes that are performed to make digital assets press ready and the creation of physical assets such as plates or cut dies that are required for printing or converting.

6.3.1 AssetListCreation

New in JDF 1.2

The purpose of this process is to provide a listing of all assets and their dependent assets that are required in order to use the input assets. This process analyzes the input [RunList](#) to find dependent assets to provides a complete listing of files in the output [RunList](#). [AssetListCreation](#) does not package, encode or compress the list of files.

Table 6.20: AssetListCreation – Input Resources

NAME	DESCRIPTION
AssetListCreationParams	Parameters of the AssetListCreation process
RunList	List of assets used to create a listing of dependent assets.

Table 6.21: AssetListCreation – Output Resources

NAME	DESCRIPTION
RunList	A listing of all assets that the assets listed in the input RunList are dependent on including the input assets. The dependent assets are to be inserted into the output RunList as RunList/LayoutElement/Dependencies/LayoutElement .

6.3.2 Bending

New in JDF 1.3

The [Bending](#) device consumes a printing plate and bends and/or punches it. In contrast to commercial printing, for newspaper printing this process is not integrated into the [ImageSetting](#) process. In **JDF 1.3** and above [ImageSetting](#) does not imply [Bending](#). An in-line plate puncher SHOULD be modeled as a combined process consisting of [ImageSetting](#) and [Bending](#) processes.

Table 6.22: Bending – Input Resources (Sheet 1 of 2)

NAME	DESCRIPTION
BendingParams	List of assets used to create a listing of dependent assets.

Table 6.22: Bending – Input Resources (Sheet 2 of 2)

NAME	DESCRIPTION
ExposedMedia	The ExposedMedia resource to be bent/punched.
Media ?	In a newspaper environment, Dummy forms might be needed. In this case, a Media with @MediaType = "Plate" serves as an input resource.

Table 6.23: Bending – Output Resources

NAME	DESCRIPTION
ExposedMedia	The bent/punched ExposedMedia resource.

6.3.3 ColorCorrection

ColorCorrection is the process of modifying the specification of colors in documents to achieve some desired visual result. The process might be performed to ensure consistent colors across multiple files of a job or to achieve a specific design intent (e.g., “brighten the image up a little”).

ColorCorrection is distinct from **ColorSpaceConversion**, which is the process of changing how the colors specified in the job will be produced on paper. Rather, **ColorCorrection** is the process of modifying the desired result, whatever the specified color space might be.

The **ColorCorrection** process MAY be part of a combined process with the **ColorSpaceConversion** process, in which case the source and destination profiles used by the **ColorSpaceConversion** process would be supplied from [ColorSpaceConversionParams](#). Either the direct [@Adjustment](#) attribute or the ICC profile attribute [ColorCorrectionOp/FileSpec](#) with [@ResourceUsage](#) = "AbstractProfile" can be used in this scenario to apply color corrections in the device independent ICC Profile Connection Space interpreted from the ICC source profile before the ICC destination profile is applied.

Alternatively, a **ColorCorrection** process MAY occur after a **ColorSpaceConversion** process. In this scenario only the [ColorCorrectionOp/FileSpec](#) with [@ResourceUsage](#)="DeviceLinkProfile" supplied in [ColorCorrectionOp](#) is used.

Table 6.24: ColorCorrection – Input Resources

NAME	DESCRIPTION
ColorantControl ? Modified in JDF 1.1A	Identifies the assumed color model for the job.
ColorCorrectionParams New in JDF 1.1	Parameters of the ColorCorrection process
RunList	List of content elements that SHALL be operated on.

Table 6.25: ColorCorrection – Output Resources

NAME	DESCRIPTION
RunList	List of color-corrected content elements.

6.3.4 ColorSpaceConversion

ColorSpaceConversion is the process of converting colors that are provided in a PDL to another color space. There are two ways in which a controller can use this process to accomplish the color conversion. It can simply order the colors to be converted by the device assigned to the task, or it can request that the process simply tag the input data for eventual conversion. Additionally, the process can remove all tags from the PDL.

Like all other color manipulation supported in **JDF**, the color conversion controls are based on the use of ICC profiles. While the assumed characterization of input data can take many forms, each can internally be represented as an ICC profile. In order to perform the transformations, input profiles SHALL be paired with the identified final target device profile to create the transformation.

The target profile for color space conversion selection should be based on [ColorSpaceConversionParams/@ICCProfileUsage](#) in the following order of precedence.

PROCESSES

- **UsePDL** – If present, the embedded target profile SHALL be used.
- **UseSupplied** – The embedded target profile SHALL NOT be used.

In order to avoid the loss of black color fidelity resulting from the transformation from a four-component CMYK to a three-component interchange space, the agent MAY provide a DeviceLink¹ transform in **ColorSpaceConversionParams/ColorSpaceConversionOp/FitPolicy**[@ResourceUsage="DeviceLinkProfile"]. The transform SHALL be applied when converting from a specific source color space to the final target device color space specified for the **ColorSpaceConversion** operation being applied. In these instances, the final target profile SHALL NOT be specified in **ColorSpaceConversionParams/FitPolicy**.

Table 6.26: ColorSpaceConversion – Input Resources

NAME	DESCRIPTION
ColorantControl ? Modified in JDF 1.1A	Identifies the assumed color model for the job.
ColorSpaceConversionParams	Parameters that define how color spaces will be converted in the file.
RunList	List of pages, sheets or byte maps on which to perform the selected operation.

Table 6.27: ColorSpaceConversion – Output Resources

NAME	DESCRIPTION
ColorantControl ?	Identifies the assumed color model for the job. The ColorantControl resource MAY be modified by a ColorSpaceConversion process.
RunList	List of pages, sheets or byte maps on which the selected operation has been performed.

6.3.5 ContactCopying

New in JDF 1.1

ContactCopying is the process of making an analog copy of a film onto a another film or plate. It includes **FilmToPlateCopying** as defined in **JDF 1.0** and deprecated in **JDF 1.1**.

Table 6.28: ContactCopying – Input Resources

NAME	DESCRIPTION
ContactCopyParams	The settings of the contact copying task.
DevelopingParams ?	Controls the physical and chemical specifics of the media development process.
ExposedMedia +	The film or films to be copied onto the film or plate.
Media ?	The unexposed film or plate.
TransferCurvePool ?	Area coverage correction and coordinate transformations of the device.

Table 6.29: ContactCopying – Output Resources

NAME	DESCRIPTION
ExposedMedia	The resulting exposed contact copy.

1. A DeviceLink transform is a transform that is defined in an ICC profile file (see ▶ [ICC.1]) that maps directly from one specific source color space to a specific destination device color space. An example of this is a transform that maps directly from PDL source objects defined using sRGB directly to SWOP CMYK.

6.3.6 ContoneCalibration

This process specifies the process of contone calibration. It consumes contone raster data such as the output from a **Rendering** process. It produces contone raster data that has been calibrated using information about the intended screening to correctly calibrate the contone data.

Table 6.30: ContoneCalibration – Input Resources

NAME	DESCRIPTION
RunList	Ordered list of rasterized byte maps representing pages or surfaces.
ScreeningParams ? Modified in JDF 1.1	Metadata specifying which halftoning mechanism it is intended to be applied in a subsequent Screening process.
TransferFunctionControl ? Modified in JDF 1.1	Specifies which calibration to apply.

Table 6.31: ContoneCalibration – Output Resources

NAME	DESCRIPTION
RunList	Ordered list of rasterized byte maps representing pages or surfaces.

6.3.7 CylinderLayoutPreparation

New in JDF 1.3

CylinderLayoutPreparation specifies where to mount a single form in a newspaper-Web Press. This information might be needed by printers as human-readable text on the surface of the form. Usually, the information is shown in a non-printable area of the form.

The required color information for each plate layout is addressed by [Layout/ContentObject/@Ord](#). The attribute points to [RunList \(Document\)](#). [RunList/@PageListIndex](#) points to detailed [PageData](#), including individual color information.

Table 6.32: CylinderLayoutPreparation – Input Resources

NAME	DESCRIPTION
CylinderLayoutPreparationParams ?	Set of parameters for CylinderLayoutPreparation .
Layout	Definition of the Layout of the individual plates. The resulting CylinderLayout references plate layouts.
RunList	The document RunList .

Table 6.33: CylinderLayoutPreparation – Output Resources

NAME	DESCRIPTION
CylinderLayout	CylinderLayout specifies where to mount a single form in a newspaper-Web Press. If requested by the printer, this information can be indicated as human-readable text on the surface of the physical plate.

6.3.8 DBDocTemplateLayout

Deprecated in JDF 1.5

Deprecation note: Starting with JDF 1.5, use [LayoutElementProduction](#) instead.

6.3.9 DBTemplateMerging

Deprecated in JDF 1.5

Deprecation note: Starting with JDF 1.5, use [LayoutElementProduction](#) instead.

6.3.10 DieDesign

New in JDF 1.4

PROCESSES

This process describes the design of a die tool set with one or more stations starting from a **DieLayout** that describes the layout of the one-up designs on a die. The output of this process is a **DieLayout** resource, describing a tool set for the die cutter machine that can be used in a subsequent **DieMaking** process. **DieDesign** typically follows **DieLayoutProduction**.

Table 6.34: DieDesign – Input Resources

NAME	DESCRIPTION
DieLayout	A resource describing the die cutter layout.

Table 6.35: DieDesign – Output Resources

NAME	DESCRIPTION
DieLayout +	A set of resources describing the die cutter tool set.

6.3.11 DieLayoutProduction

New in JDF 1.4

This process describes the layout of one or more structural designs for a given **Media**. The output of this process is a **DieLayout** resource describing the positioning of the individual one-ups on the die. The **DieLayoutProduction** process can be performed by a human operator using a CAD application. In some cases it can be an automated process. The process can be run in estimation mode; in which case multiple solutions are returned that can then be used as input of a cost estimation module to determine the optimal layout. The **DieLayoutProduction** process is the packaging equivalent of a **Stripping** process in conventional printing. The output **DieLayout** of **DieLayoutProduction** is typically the input of a subsequent **DieDesign** process.

Table 6.36: DieLayoutProduction – Input Resources

NAME	DESCRIPTION
DieLayoutProductionParams	The parameters for DieLayoutProduction .
ShapeDef +	ShapeDef resources describing the different 1-up structural designs to be stepped and repeated on the Media .

Table 6.37: DieLayoutProduction – Output Resources

NAME	DESCRIPTION
DieLayout +	A resource describing the die cutter tool set. When the process is run in estimation mode, multiple alternative DieLayout elements are returned, otherwise a single DieLayout is generated.

Example 6.1: DieLayoutProduction: Single Shape and Two Sheet Sizes

Example of **DieLayoutProduction** of a single shape on 2 stock sheet sizes.

```
<!-- DieLayoutProduction Sample
      Date:Sept 2007 Version: 1.00
      Single Shape is repeated on a range of alternative sheet sizes.
-->
<JDF DescriptiveName="Single shape versus a set of sheet sizes"
  ID="n001" JobPartID="ID234" Status="Waiting"
  Type="DieLayoutProduction" Version="1.6" xmlns="http://www.CIP4.org/JDFSchema_1_1">
  <ResourcePool>
    <ShapeDef Class="Parameter" ID="ShapeUp" Status="Available">
      <FileSpec URL="file://myserver/myshare/olive.dd3"/>
    </ShapeDef>
    <!-- Layout can chose from 2 stock sheet sizes. Nesting with 2nd row
          rotated and secondary gutters. Rotate against grain/flute
          is not allowed.
    -->
    <DieLayoutProductionParams Class="Parameter" ID="LayParam" Status="Available">
      <ConvertingConfig SheetHeight="2267.72 ~ 2267.72" SheetWidth="2834.64 ~ 2834.64"/>
      <ConvertingConfig SheetHeight="2834.64 ~ 2834.64" SheetWidth="3401.57 ~ 3401.57"/>
      <RepeatDesc AllowedRotate="None" GutterY="0.0" GutterY2="14.17" LayoutStyle="Reverse2ndRow"/>
    </DieLayoutProductionParams>
    <!-- The layout with minimum waste will be returned as the final result. -->
    <DieLayout Class="Parameter" ID="DieLay" Status="Unavailable"/>
  </ResourcePool>
  <ResourceLinkPool>
    <ShapeDefLink Usage="Input" rRef="ShapeUp"/>
    <DieLayoutProductionParamsLink Usage="Input" rRef="LayParam"/>
    <DieLayoutLink Usage="Output" rRef="DieLay"/>
  </ResourceLinkPool>
</JDF>
```

Example 6.2: DieLayoutProduction: Single Shape and Range of Sheet Sizes

Example of **DieLayoutProduction** of a single shape on a range of sheet sizes. The sheet sizes have defined minimum and maximum width and height. The layout is optimized for a particular order quantity.

```
<!-- DieLayoutProduction Sample
      Date:Sept 2007 Version: 1.00
      Single Shape is repeated on a continuous range of sheet sizes. -->
<JDF DescriptiveName="Single shape versus a set of sheet sizes"
  ID="n001" JobPartID="ID400" Status="Waiting"
  Type="DieLayoutProduction" Version="1.6" xmlns="http://www.CIP4.org/JDFSchema_1_1">
  <ResourcePool>
    <ShapeDef Class="Parameter" ID="ShapeUp" Status="Available">
      <FileSpec URL="file://myserver/myshare/olive.dd3"/>
    </ShapeDef>
    <!-- Layout can choose sheet sizes between 1200mm-1000mm wide and
          1000mm-800mm high. The layout will be optimized for order quantities
          of 1 million boxes. Gutters are 5mm and cross flute/grain rotation
          is not allowed.
    -->
    <DieLayoutProductionParams Class="Parameter" ID="LayParam" Status="Available">
      <ConvertingConfig SheetHeight="2834.64 ~ 2267.72" SheetWidth="3401.57 ~ 2834.64"/>
      <RepeatDesc AllowedRotate="None" GutterX="14.17" GutterY="14.17" OrderQuantity="1000000"/>
    </DieLayoutProductionParams>
    <!-- The layout with minimum waste will be returned as the
          final result. -->
    <DieLayout Class="Parameter" ID="DieLay" Status="Unavailable"/>
  </ResourcePool>
  <ResourceLinkPool>
    <ShapeDefLink Usage="Input" rRef="ShapeUp"/>
    <DieLayoutProductionParamsLink Usage="Input" rRef="LayParam"/>
    <DieLayoutLink Usage="Output" rRef="DieLay"/>
  </ResourceLinkPool>
</JDF>
```

Example 6.3: DieLayoutProduction: Two Shapes and Range of Sheet Sizes

Example of **DieLayoutProduction** of 2 shapes on a range of sheet sizes. The sheet sizes have defined minimum and maximum width and height. The layout is optimized for a particular order quantity of 2 boxes.

```
<!-- DieLayoutProduction Sample
    Date:Sept 2007 Version: 1.00
    2 Shapes is repeated on a continuous range of sheet sizes.
-->
<JDF DescriptiveName="Single shape versus a set of sheet sizes"
    ID="n001" Status="Waiting" Type="DieLayoutProduction" Version="1.6" xmlns="http://www.CIP4.org/
JDFSchema_1_1">
  <ResourcePool>
    <ShapeDef Class="Parameter" ID="ShapelUp" Status="Available">
      <FileSpec URL="file://myserver/myshare/beef.dd3"/>
    </ShapeDef>
    <ShapeDef Class="Parameter" ID="ShapelUp2" Status="Available">
      <FileSpec URL="file://myserver/myshare/chicken.dd3"/>
    </ShapeDef>
    <!-- Layout can chose sheetsizes between 1200mm-1000mm wide and
    1000mm-800mm high. Layout is optimized for an order
    quantity of 300k boxes for beef and 700k boxes for chicken.
    Gutters are 5mm and cross flute/grain rotation is not allowed.
    -->
    <DieLayoutProductionParams Class="Parameter" ID="LayParam" Status="Available">
      <ConvertingConfig SheetHeight="2834.64 ~ 2267.72" SheetWidth="3401.57 ~ 2834.64"/>
      <RepeatDesc AllowedRotate="None" GutterX="14.17" GutterY="14.17" OrderQuantity="300000"/>
      <RepeatDesc AllowedRotate="None" GutterX="14.17" GutterY="14.17" OrderQuantity="700000"/>
    </DieLayoutProductionParams>
    <!-- The layout with minimum waste will be returned as the final
    result. -->
    <DieLayout Class="Parameter" ID="DieLay" Status="Unavailable"/>
  </ResourcePool>
  <ResourceLinkPool>
    <ShapeDefLink Usage="Input" rRef="ShapelUp"/>
    <ShapeDefLink Usage="Input" rRef="ShapelUp2"/>
    <DieLayoutProductionParamsLink Usage="Input" rRef="LayParam"/>
    <DieLayoutLink Usage="Output" rRef="DieLay"/>
  </ResourceLinkPool>
</JDF>
```

6.3.12 DigitalDelivery

New in JDF 1.2

This process specifies the delivery of digital assets in any stage of the flow. It could be images, documents, layout, text files, ready to print raster files or any other file type. When **ArtDeliveryIntent/ArtDelivery/@ArtDeliveryType** is "DigitalNetwork" or "DigitalFile" the corresponding process will be **DigitalDelivery** unless **ArtDeliveryIntent/@Method** = "local".

It is not necessary to use the **DigitalDelivery** process to describe informal delivery of files during the workflow, although **DigitalDelivery** can be used for asset collection purposes (i.e., defining how an input **RunList** will be collected in the output **RunList** describing the packing containers of compression or encoding).

Table 6.38: DigitalDelivery – Input Resources

NAME	DESCRIPTION
DigitalDeliveryParams	Parameter specifying the artwork files delivery characteristics.
RunList * Modified in JDF 1.3	The list of digital files to be delivered.

Table 6.39: DigitalDelivery – Output Resources

NAME	DESCRIPTION
RunList + Modified in JDF 1.3	The list of digital files which were actually delivered to the destination.

6.3.13 FilmToPlateCopying

Deprecated in JDF 1.1

FilmToPlateCopying has been replaced by the more generic **ContactCopying**.

6.3.14 FormatConversion

New in JDF 1.1

Deprecated in JDF 1.5

Deprecation note: Starting with **JDF 1.5**, use a Combined process of **RasterReading** and **Rendering**.

6.3.15 ImageEnhancement

New in JDF 1.5

The **ImageEnhancement** process describes generic image data processing.

Note: The source MAY be any image, but also text or vector graphics.

Table 6.40: ImageEnhancement – Input Resources

NAME	DESCRIPTION
ImageEnhancementParams	Describes the controls selected for the manipulation of images.
RunList	List of content data elements on which to perform the selected operations.

Table 6.41: ImageEnhancement – Output Resources

NAME	DESCRIPTION
RunList	List of page contents with images that have been manipulated as indicated by the ImageEnhancementParams resource.

6.3.16 ImageReplacement

This process provides a mechanism for manipulating documents that contain referenced image data. It allows for the “fattening” of files that simply contain a reference to external data or contain a low resolution proxy. Additionally, the resource can be specified so that this process generates proxy images from referenced data. **ImageReplacement** is intentionally neutral of the conventions used to identify the externally referenced image data.

Table 6.42: ImageReplacement – Input Resources

NAME	DESCRIPTION
ImageCompressionParams New in JDF 1.1	This resource provides a set of controls that determines how images will be compressed in the resulting “fat” PDL pages.
ImageReplacementParams	Describes the controls selected for the manipulation of images.
RunList ?	List of page contents on which to perform the selected operation.

Table 6.43: ImageReplacement – Output Resources

NAME	DESCRIPTION
RunList	List of page contents with images that have been manipulated as indicated by the ImageReplacementParams resource.

6.3.17 ImageSetting

The **ImageSetting** process is executed by an imagesetter or platesetter that images a bitmap onto the film or plate media. The **ImageSetting** process can also be used to describe hard copy proofing (see ▶ Section 6.2.1 Approval).

Table 6.44: ImageSetting – Input Resources

NAME	DESCRIPTION
ColorantControl ? New in JDF 1.2	The ColorantControl resources that define the ordering and usage of inks during marking on the imagesetter.
DevelopingParams ? New in JDF 1.1	Controls the physical and chemical specifics of the media development process.
ExposedMedia ? New in JDF 1.3	When imaging to reusable media, ExposedMedia MAY also be used as input to ImageSetting . Constraint: exactly one of Media or ExposedMedia SHALL be specified.
ImageSetterParams ? Modified in JDF 1.1	Controls the device specific features of the imagesetter.
Media ?	The unexposed media. Constraint: exactly one of Media or ExposedMedia SHALL be specified.
RunList ?	Identifies the set of bitmaps to image. MAY contain bytemaps or images.
TransferCurvePool ? New in JDF 1.1	Area coverage correction and coordinate transformations of the device.

Table 6.45: ImageSetting – Output Resources

NAME	DESCRIPTION
ExposedMedia	The exposed media resource. In case of film setting, this is the exposed set of films.

6.3.18 Imposition

Modified in JDF 1.4

Modification note: Starting with **JDF 1.4**, automated imposition is added.

The **Imposition** process is responsible for combining pages of input graphical content onto surfaces whose dimensions are reflective of the physical output media. Static or dynamic printer's marks can be added to the surface in order to facilitate various aspects of the production process. Among other things, these marks are used for press alignment, color calibration, job identification, and as guides for cutting and folding.

Note: The **Imposition** process specifies the task of combining pages and marks on sheets. The task of setting up the parameters needed for **Imposition** (e.g., creating the **Layout** resource) is defined either by **LayoutPreparation**, **Stripping** or by the generic **ResourceDefinition** process.

Table 6.46: Imposition – Input Resources

NAME	DESCRIPTION
Layout	A Layout resource that indicates how the content pages from the Document RunList and marks from the Marks RunList (see below) are combined onto imposed surfaces.
RunList (Document)	Structured list of incoming page contents that are transformed to produce the imposed surface images.
RunList (Marks) ?	Structured list of incoming marks. These are typically printer's marks such as fold marks, cut marks, punch marks or color bars.

Table 6.47: Imposition – Output Resources

NAME	DESCRIPTION
RunList	The RunList represents a structured list of imposed surfaces. The @ElementType of the LayoutElement resource SHALL be "Surface". Conceptually the output RunList will be partitioned by at least @PartIDKeys="SheetName Side" to represent the individual printed surfaces. If the Imposition process is executed before any raster image processing, this will generally be consumed by an Interpreting process. In the case of where Imposition is executed after any raster image processing, it will be consumed by DigitalPrinting or ImageSetting .

There are two mechanisms provided for controlling the flow of page images onto sheet surfaces:

The default mechanism is for non-automated (e.g., fully-specified) **Imposition**. Fully-specified imposition explicitly identifies all page content for each sheet imaged and references these pages by means of the order in which they are defined in the input **RunList (Document)** resource. Static printer's marks are referenced in a similar fashion from the input **RunList (Marks)** resource.

Setting the **@Automated** attribute of the **Layout** resource to "true" activates a template approach to imposition and relies upon the full hierarchy structure of the document (as specified by the **RunList (Document)** and referenced ▶ Structured PDL data) to specify the page content to be imposed.

In **JDF**, there is a single **Layout** resource definition. Its structure is broad enough to encompass the needs of both fully specified and template-driven imposition. When described fully (**@Automated = "false"**), the **Layout** resource partition structure defines the imposition to take place. The highest level of each partition defines a signature. The children of each of the signatures in turn specifies an array of sheets, and each sheet MAY have up to two surfaces (Front and/or Back), on which the page images and any printer's marks are to be placed using **PlacedObject** elements. A sheet that specifies no surface content SHALL be interpreted as blank. Pages that are to be printed SHALL be placed onto surfaces using **ContentObject** subelements which explicitly identify the page (Typically done using the **ContentObject/@Ord** attribute which specifies an index into the document **RunList**). Thus, the **Layout** partition hierarchy SHALL explicitly specify which pages are to be imaged onto each surface.

For **JDF 1.3**, automated imposition was originally defined such that **Layout** resource partitions specified a single signature of sheet(s) upon which page content was to be imposed. The sequence of pages to be imaged via automated imposition was defined by the document **RunList**. The pages were pulled from this sequence as needed in order to satisfy the **ContentObject** elements defined for each sheet surface in the signature of the **Layout** resource. The signature was repeated as necessary until all pages available in the document **RunList** had been used.

Note: The XML order in which the partitions of the **Layout** resource are defined is significant for both automated and non-automated imposition and defines the order in which the imposition engine SHALL create the output **RunList**.

6.3.18.1 Glossary for Automated Imposition

This table below introduces terms and concepts necessary for understanding automated imposition processing.

Table 6.48: Glossary for Automated Imposition (Sheet 1 of 4)

TERM	DEFINITION
Base Index	When processing an ▶ Imposition Template, the imposition engine maintains an internal Base Index into the ▶ Page Pool being processed. That Base Index is added to the ContentObject/@Ord value, resulting in an index into the ▶ Page Pool for referencing the page to be placed, and is updated for each ▶ Imposition Template iteration. Both positive and negative base indices are maintained for use when ContentObject/@Ord has either a negative or positive value.
Base Ord	Same as ▶ Base Index.
Collect	Set of sheets that are collected together prior to gathering.
Document Major Processing Order	Document Major Processing Order refers to the scenario wherein all instances of a given document class (across all sets to be processed) SHALL be produced before starting processing for the next document class. For instance, the production requirements may state that all brochures SHALL be produced for each set, followed by all cover letters and then all postcards. This processing order is an example of Document Major.

Table 6.48: Glossary for Automated Imposition (Sheet 2 of 4)

TERM	DEFINITION
Imposed Sheet Set	<p>Describes a single set of sheet definitions generated by the imposition engine containing imposed content.</p> <p>Note: This may represent a pre-cut set of sheets in a cut-and-stack workflow (where the maximum number of sheets in the ▶ Imposed Sheet Set is defined by Layout/LogicalStackParams/@MaxStackDepth), or a collect when no ▶ Logical Stacks are defined.</p>
Imposition Template	<p>A first-level branch of a partitioned Layout resource having <code>@Automated = "true"</code> that describes a single set of sheets with a common imposition layout that accommodates very specific production characteristics. A single Layout resource defines a collection of one or more Imposition Templates.</p>
Instance Document	<p>The imposition engine treats each immediate child node of a set in a ▶ Structured PDL as an Instance Document. This is used as the basis for generating <code>@EndOfDocument</code> breaks in the resulting RunList (Surface), and for processing RunList/@DocCopies attributes (see ▶ Section 8.130 RunList). If a set has only pages as its children, then a single ▶ Instance Document is assumed to exist.</p>
Logical Sheet	<p>One or more pages placed onto a sheet definition within a ▶ Logical Stack (i.e., a sheet definition within a ▶ Logical Stack).</p>
Logical Stack	<p>When Layout/LogicalStackParams/@MaxStackDepth is specified in the root of the Layout resource, then the imposition engine is configured for imposition onto multiple Logical Stacks. These stacks are described through the use of adding Layout/PlacedObject/@LogicalStackOrd to stack-specific descriptions for each placed object. For more information, see ▶ Section 6.3.18.4.1 Using Logical Stacks.</p>
Logical Stack Set	<p>The set of ▶ Logical Stacks described by an ▶ Imposed Sheet Set.</p>
Page Pool	<p>A Page Pool refers to a delimited sequence of pages defined within the RunList (Document) input to the Imposition process. A Page Pool MAY encompass all pages of the RunList (Document) as in the case of ▶ Unstructured PDLs. In the case of ▶ Structured PDLs, a Page Pool is defined to be that set of pages represented by a leaf node of the document structure. For example, a brochure which has a sub-structure of cover and body has two leaf nodes, cover and body, respectively. If body were further divided into chapter sections, then the leaf nodes of the brochure would be the cover and each body chapter. LayoutElement/@ElementType may be used to demote an already ▶ Structured PDL to be treated as an ▶ Unstructured PDL. Examples of ▶ Structured PDL formats include PPML, PPML/VDX, and ISO 16612-2 PDF/VT.</p> <p>▶ Imposition Templates select Page Pools to be processed based on their partition keys whose values are derived from metadata present in the PDL data (e.g., Layout partitioned by <code>@DocTags = "Letter"</code> would process all Page Pools of the current set whose metadata derived partition key <code>@DocTags</code> matches "Letter"). See below for more detail.</p> <p>It is important to note that the pages in a Page Pool SHALL be presented to the imposition engine in a well defined order known to the Layout resource creator (typically reader order) in order for them to be processed correctly.</p>
Page Pool List	<p>A Page Pool List refers to a sequence of one or more ▶ Page Pools (contiguous or disjoint in the RunList (Document)) aggregated together and treated as a single ▶ Page Pool for processing by a selected ▶ Imposition Template. For example, if a Page Pool List is constructed from the ▶ Page Pools: Chapter1, Chapter2, and Chapter4 as defined in an input RunList (Document), then the aggregate result is a single pool of pages consisting of the pages from Chapter1, Chapter2 and Chapter4. The order of the pages of the Page Pool List SHALL be processed in the order in which the ▶ Page Pools are defined in the RunList (Document). The boundaries between ▶ Page Pools in a Page Pool List are implicitly maintained for use by the imposition processor for making page level sheet surface mapping decisions during processing (e.g., specifying a right side facing pages start at the beginning of each chapter). ▶ Page Pools are aggregated into Page Pool Lists through the use of the Layout/@BaseOrdReset attribute. If <code>@BaseOrdReset = "PagePoolList"</code> then all ▶ Page Pools processed by the ▶ Imposition Template are aggregated. If <code>@BaseOrdReset = "PagePool"</code>, then each ▶ Page Pool is processed separately.</p> <p>It is important to note that the pages in a Page Pool List SHALL be presented to the imposition engine in a well defined order known to the Layout resource creator (typically reader order) in order for them to be processed correctly.</p>

Table 6.48: Glossary for Automated Imposition (Sheet 3 of 4)

TERM	DEFINITION
PDL Metadata	<p>Various PDL formats provide for the definition of key/value pairs within the PDL that MAY be treated as metadata for the purpose of process parameterization. For example, the metadata key/value pairs specified in the PDL data may identify the type of finished document using <code>@DocumentType = "PostCard"</code> or <code>"Booklet"</code>, which would then affect the selection of the ▶ Imposition Template to be applied.</p> <p>The Imposition process makes use of metadata to make decisions as to which ▶ Page Pools should be processed through an ▶ Imposition Template. These decisions are performed by comparing the explicit partition key settings for each ▶ Imposition Template to the partition key/value settings mapped from the PDL for each ▶ Page Pool in the current set, and each matching ▶ Page Pool is processed through the corresponding ▶ Imposition Template(s).</p> <p>Within an ▶ Imposition Template, metadata associated with individual pages MAY also be used to parameterize dynamic mark and slug-line content generation (see example below). Refer to the RunList/MetadataMap element definition for information on how to specify the mapping of PDL specified metadata values for use by JDF (e.g., using partition keys or GeneralID keys).</p> <p>The ▶ PDL Processor SHALL make use of the RunList/MetadataMap to generate partition keys, GeneralID and other values during the course of imposition processing. These values SHALL be regenerated as necessary, as the metadata key/value pairs in the PDL change based on which portion of the PDL is being processed.</p>
PDL Processor	A PDL interface that hides details of a particular PDL and syntax, etc. from the imposition engine itself. Its role is to present the structure of the PDL and pools of pages within the PDL structure to the imposition engine in a PDL independent way.
Recipient Set	Set of finished pages produced for a single recipient.
Set Major Processing Order	Set Major Processing Order refers to the scenario when all documents of a set instance are produced before starting on the next set instance; this is the typical processing order for most VDP applications.
Sheet Definition	A branch of an ▶ Imposition Template that describes the imposition to be performed for a sheet. ▶ Sheet Definitions for automated imposition SHALL be partitioned by <code>@SheetName</code> and <code>@Side</code> .
Structured PDL	<p>A Structured PDL defines sequences of groupings of pages. These groupings may be as simple as specifying the set of pages belonging to a chapter or cover of a booklet where such a group is a ▶ Page Pool. In the case of Variable Document Printing (VDP) ▶ Structured PDLs, there are often multiple sets of content where typically a set instance comprises the content to be delivered to a single recipient. Each set has one or more documents, and documents may be further subdivided into sub-documents in hierarchical fashion. The imposition engine processes each set individually in the sequence specified in the interpretation specified by the RunList that references the ▶ Structured PDL data file.</p> <p>The general structure of a Structured PDL is identified by the PDL (PDL specification or PDL instance) itself or the value of the LayoutElement/@ElementType attribute.</p>
Structured PDL – MultiDocument	<p>For MultiDocument PDL files, the PDL processor supplies the context to the imposition processor that represents the PDL's document structure. This context is defined as</p> <p>Set – represents a single set containing all of the documents in the PDL file, therefore the value of <code>@SetIndex</code> SHALL always be 0.</p> <p>Document – is always the first hierarchical level in the file.</p> <p>SubDoco to SubDoc9 – represent consecutive levels of the hierarchy below the Document level in the file not including the level representing individual pages. If any level of the hierarchy is not defined, the value of the corresponding <code>@SubDocIndexn</code> is undefined.</p> <p>Pages – represent individual pages in the PDL.</p>

Table 6.48: Glossary for Automated Imposition (Sheet 4 of 4)

TERM	DEFINITION
Structured PDL – MultiSet	<p>For MultiSet PDL files, the PDL processor supplies the context to the imposition processor that represents the PDL’s set and document structure. This context is defined as Set – represents a set of related documents.</p> <p>Document – is always the first hierarchical level below the Set level. If a MultiSet file contains only Sets with no document or sub-document breaks (no levels are defined below the Set level), all of the pages of the set are considered to be included in a single document therefore the <i>@DocIndex</i> is always 0.</p> <p>SubDoc0 to SubDoc9 – represent consecutive levels of the hierarchy below the Document level in the file not including the level representing individual pages. If any level of the hierarchy is not defined, the value of the corresponding <i>@SubDocIndexn</i> is undefined.</p> <p>Pages – represent individual pages in the PDL.</p> <p>Note: The lowest level of the JDF hierarchy (Set, Document, SubDocn) mapped by the PDL processor represents a ▶ Page Pool context.</p>
Unstructured PDL	<p>An Unstructured PDL is a content file consisting of a single set of one or more pages. Typically such a PDL file is considered to be a single document and a single Layout ▶ Imposition Template would be applied to the entire set of pages. When a JDF imposes structure on such a file either using direct <i>@Page</i> indices or a partitioned RunList pointing to different page ranges of the file using <i>@EndOfSet</i>, <i>@EndOfDocument</i> attributes, then the imposition engine will treat the input RunList resource as a ▶ Structured PDL.</p>

6.3.18.2 Variables for Automated Imposition

The imposition engine maintains a set of locally scoped variables that may be referenced during imposition processing. The values of these variables reflect the current context of processing during execution of the Imposition process. These variables include those described in ▶ Section H String Generation, as well as those described in bulleted items below. All variables below are integer variables.

Table 6.49: Variables for Automated Imposition (Sheet 1 of 2)

NAME	DATA TYPE	DESCRIPTION
<i>CollectIndex</i> ?	integer	Represents a zero based index of the current collect of sheets being generated by an automated ▶ Imposition Template from the current ▶ Page Pool or ▶ Page Pool List being processed. May be greater than zero if Layout/ <i>@MaxCollect</i> is specified and is greater than 1.
<i>CollectSheetIndex</i> ?	integer	Is a zero-based index of the current physical or ▶ Logical Sheet of the current collect generated by an automated ▶ Imposition Template from the current ▶ Page Pool or ▶ Page Pool List being processed. ▶ Logical Sheets are used when ▶ Logical Stacks are defined.
<i>ImposedSheetSetIndex</i> ?	integer	Is the 0-based ▶ Imposed Sheet Set index.
<i>PoolSheetIndex</i> ?	integer	Is a zero-based index of the current physical or logical sheet generated from the current ▶ Page Pool or ▶ Page Pool List within an automated ▶ Imposition Template. ▶ Logical Sheets are used when ▶ Logical Stacks are defined. The value of this variable is independent of the number of collects generated by the same automated ▶ Imposition Template.
<i>SheetCount</i> ?	integer	Is the current number of physical or logical sheets generated during the processing of the automated Layout resource. ▶ Logical Sheets are used when ▶ Logical Stacks are defined. At the beginning of processing of the Layout resource, the value of this variable is set to zero. The value of this variable MAY be reset to zero in later Layout partitions using the Layout/ <i>@SheetCountReset</i> attribute. <i>@SheetCount</i> is always reset to zero at the beginning of processing of a set regardless of the value of Layout/ <i>@SheetCountReset</i> .
<i>SubDocIndexn</i> ?	integer	Where <i>n</i> represents any hierarchical structure levels below the level of the current document present in the ▶ Structured PDL data to be processed. For example, <i>@SubDocIndex0</i> might represent a collection of chapters in a brochure where its containing parent is at the document level (<i>@DocIndex</i> is used to indicate the position (index) of the document in its containing Set).

Table 6.49: Variables for Automated Imposition (Sheet 2 of 2)

NAME	DATA TYPE	DESCRIPTION
<i>TotalCollects</i> ?	integer	Is the total number of collects generated by an automated ▶ Imposition Template from the current ▶ Page Pool or ▶ Page Pool List being processed.
<i>TotalImposedSheetSets</i> ?	integer	Is the total number of ▶ Imposed Sheet Sets defined for the job.
<i>TotalSets</i> ?	integer	Is the total number of recipient sets generated for the job. Note that in cases where it is used before the end of content imposition, it is necessary for the imposition processor to count the number of sets in the PDL content.
<i>TotalSheetCount</i> ?	integer	Is the total number of physical or ▶ Logical Sheets generated during the processing of the automated <i>Layout</i> resource. ▶ Logical Sheets are used when ▶ Logical Stacks are defined. The value of this variable MAY be recalculated in later <i>Layout</i> partitions using the <i>Layout/@SheetCountReset</i> attribute. <i>@TotalSheetCount</i> is always reset to zero at the beginning of processing of a set regardless of the value of <i>Layout/@SheetCountReset</i> .
<i>TotalSheetsInCollect</i> ?	integer	Is the total number of physical or ▶ Logical Sheets that make up the current collect generated by an automated ▶ Imposition Template from the current ▶ Page Pool or ▶ Page Pool List being processed. ▶ Logical Sheets are used when ▶ Logical Stacks are defined.
<i>TotalSheetsInPool</i> ?	integer	Is the total number of physical or ▶ Logical Sheets generated from the current page pool or page pool list within an automated ▶ Imposition Template. ▶ Logical Sheets are used when ▶ Logical Stacks are defined.

The above variables MAY be used for controlling the activation of printer's marks (See *Layout/MarkObject/MarkActivation*). For example:

Example 6.4: Automated Imposition: MarkObject

This example causes a slug line to be imaged on the bottom center of the first sheet of the set of sheets comprising a signature instance. Here are the details. For *MarkActivation/@Context*, its value of "CollectIndex" specifies that the value of *@CollectIndex* is the index used with *MarkActivation/@Index*. For *Layout/@Index*, its value of 0 specifies that the sheet receive the specified slug line if the value of *@CollectIndex* is 0 (i.e., if it is first sheet of the signature instance).

Note: If *@Index* were "146", then the slug line would go on the second, fifth and seventh sheets.

```
<MarkObject Anchor="BottomCenter" CTM="1 0 0 1 0 0">
  <DeviceMark Font="MySlugLineFont" FontSize="8"/>
  <!--Result: Gender=male -->
  <JobField JobFormat="Gender=%s" JobTemplate="GeneralID:Gender"/>
  <RefAnchor Anchor="BottomCenter" AnchorType="Sibling" rRef="1000006"/>
  <MarkActivation Context="CollectIndex" Index="0"/>
</MarkObject>
```

6.3.18.3 Execution Model for Automated Imposition

The **Imposition** process transforms the sequences of pages contained within a ▶ Page Pool or ▶ Page Pool List to a specific sequence of imposed sheet surfaces. The ▶ Imposition Templates and the order of the ▶ Imposition Templates defined by the *Layout* resource explicitly define the 'page to sheet' surface mapping transformation applied by the imposition engine.

The pseudo-code below describes the processing performed by the imposition engine at a high level:

```
For each set in the order specified in the input RunList (Document)
  For each Imposition Template
    For each Page Pool in the set
      If the partition key conditions for the Imposition Template are satisfied
        Process the Page Pool through the Imposition Template
```

Note: The emphasised terms in the above sample are defined in ▶ Table 6.48 Glossary for Automated Imposition.

Thus, each *Layout* Resource ▶ Imposition Template is processed in the XML structure order specified. Every ▶ Page Pool belonging to the current set is then evaluated against the partition keys specified for that ▶ Imposition Template to determine if it SHALL be processed by that ▶ Imposition Template.

Since each ▶ Page Pool is evaluated for each ▶ Imposition Template, it is possible to reuse the same ▶ Page Pool with multiple ▶ Imposition Templates.

The **RunList** resource output from the **Imposition** process represents a sequence of imposed sheet surfaces where each surface may be represented either by pointing to PDL content where all the input pages are imposed onto single PDL pages, or, when used with a combined process, may refer to the page set along with imposition instructions to the interpreter using an exchange resource. The structure of the **Layout** resource affects the partition keys conserved by its output **RunList** (and its referenced content), by conserving all partition keys specified in the **Layout** along with generating all of the appropriate partition keys, such as **@SetIndex**, **@DocIndex**, **@SheetIndex**. The output **RunList** can be viewed conceptually as a collection of sheet surface pairings (front and back) that conserves information about which **Layout** ▶ Imposition Template and ▶ Page Pool metadata that was in scope at the time the sheets were generated.

Note: **@DocIndex** is always generated even if every set contains only a single document; a set that contains only pages is treated as a set with a single document.

Note: **MarkObject/@Ord** works in the same way for automated imposition as for non-automated imposition. In other words, the **@Ord** value corresponds to the page entry described by that absolute **@Ord** position in the **RunList** (Marks).

Example 6.5: Imposition Template: Layout

Thus, if the ▶ Imposition Template (**Layout**) in this example is applied, then the resulting **RunList** resource conceptually conserves the following partition keys: **@SetIndex**, **@SheetIndex**, **@DocTags**, **@DocIndex**, **@SheetName** and **@Side** along with any other in-scope partition keys.

Note that in this example, **@SetIndex** and **@DocIndex** are conserved by setting **@EndOfSet** and **@EndOfDocument** respectively in the output **RunList** (**Surface**). In a **Layout** that defines ▶ Logical Stacks containing multiple documents or sets within ▶ Imposed Sheet Sets, **@SetIndex** and **@DocIndex** would need to be conserved by explicitly setting the value of the **@SetIndex** and **@DocIndex** partition keys. The **RunList** is expected to be partitioned by **@Run**, where each **@Run** represents one or more sheets, each having at least one surface either implied by **RunList/@SheetSides**, or explicitly partitioned by **@Side**.

```
<Layout Automated="true" Class="Parameter" ID="L1"
  PartIDKeys="DocTags SheetName Side" Status="Available">
  <Layout DocTags="CoverLetter">
    <Layout SheetName="CoverLetterSheets">
      <Layout Side="Front">
        <ContentObject CTM="1 0 0 1 0 0" Ord="0"/>
      </Layout>
    </Layout>
  </Layout>
  <Layout DocTags="Booklet">
    <Layout SheetName="BookletSheets">
      <Layout Side="Front">
        <ContentObject CTM="1 0 0 1 0 0" Ord="0"/>
        <ContentObject CTM="1 0 0 1 0 0" Ord="-1"/>
      </Layout>
      <Layout Side="Back">
        <ContentObject CTM="1 0 0 1 0 0" Ord="1"/>
        <ContentObject CTM="1 0 0 1 0 0" Ord="-2"/>
      </Layout>
    </Layout>
  </Layout>
</Layout>
```

6.3.18.4 Configuration for Various Automated Impositions

6.3.18.4.1 Using Logical Stacks

An ▶ Imposed Sheet Set output by the imposition engine can describe multiple ▶ Logical Stacks. Each of these ▶ Logical Stacks is placed onto a well-defined section of the sheet definitions, and after printing will typically be cut in a postpress finishing operation, generating the representative physical stacks.

- ▶ Logical Stacks are configured through the use of two mechanisms:
 - **Layout/LogicalStackParams** element specifies the control for each ▶ Logical Stack including how ▶ Logical Sheets are sequenced onto a ▶ Logical Stack, and restrictions on how ▶ Logical Sheets of ▶ Recipient Sets can span ▶ Logical Stacks and ▶ Imposed Sheet Sets.
 - The abstract **PlacedObject/@LogicalStackOrd** is used to assign individual placed object definitions to a ▶ Logical Stack. Each **PlacedObject** defines the CTM for placing that object onto the ▶ Logical Stack. Each of the **PlacedObject** elements will have the same **@Ord** value across the ▶ Logical Stacks.

To define a ▶ Logical Stack, the *Layout/LogicalStackParams* element SHALL be present in the root of the *Layout* resource. This element configures the imposition engine to place ▶ Logical Sheets within ▶ Logical Stacks. The maximum number of sheets that can make up an ▶ Imposed Sheet Set is specified by *LogicalStackParams/@MaxStackDepth*. Stacks are identified through the use of *LogicalStackParams/Stack/@LogicalStackOrd*; the first ▶ Logical Stack is *@LogicalStackOrd = "0"*, the 2nd is "1", etc.

All ▶ Logical Stacks defined by *Layout/LogicalStackParams* SHALL be used in all ▶ Imposition Templates, with the exception of an optional sheet (see *Layout/SheetCondition* in ▶ Section 8.84.14 *SheetCondition*) having a *@Condition* of "LogicalStackSetBegin" or "LogicalStackSetEnd" – these optional ▶ Logical Sheets are placed into a specific ▶ Logical Stack as specified by the *PlacedObject/@LogicalStackOrd* in the optional sheet.

The imposition works by traversing each ▶ Logical Stack (in the sequence specified by *LogicalStackParams/Stack/@LogicalStackSequence*). Each ▶ Imposition Template is processed where *PlacedObject* elements are evaluated for one of two cases:

- 1 The *PlacedObject* has no *@LogicalStackOrd*. In this case, the *PlacedObject* is considered to be a physical sheet-level object, and is placed once at the start of processing for a physical sheet. Note that only information relevant to a physical sheet (such as *@SheetIndex*) is in scope for use in generating dynamic marks. An example of a physical sheet-level mark is a cut mark for where to cut the stacks.
- 2 The *PlacedObject* has a *@LogicalStackOrd*. In this case, only *PlacedObject* elements that have a matching *@LogicalStackOrd* for the current ▶ Logical Stack being processed are placed. Note that information relevant to documents and pages (such as *@CollectIndex* or *@TotalSheetsInPool*) is in scope for use in generating dynamic marks.

When insufficient number of pages remain to complete all ▶ Logical Stacks in an ▶ Imposed Sheet Set, the imposition engine SHALL distribute all content evenly across ▶ Logical Stacks in order to minimize the number of sheets in that ▶ Imposed Sheet Set, while still honoring any restrictions specified in *Layout/SheetCondition*, *LogicalStackParams/@Restrictions* or *Layout/PageCondition*.

6.3.18.4.1.1 Imposition for Cut and Stack

This example shows how to configure for cut and stack imposition. Cut and stack produces a sequence of ▶ Imposed Sheet Sets, where each ▶ Imposed Sheet Set is cut into separate physical stacks, then each physical stack is restacked into a larger stack. This simple example is configured for 2 ▶ Logical Stacks with a *@MaxStackDepth = "3"*, and is filled with 20 pages. Content on the back of the sheet is placed head-to-head with the front content.

Note: The 2nd ▶ Imposed Sheet Set has distributed the remaining 8 pages onto 2 sheets.

Figure 6-1: Imposition for cut and stack

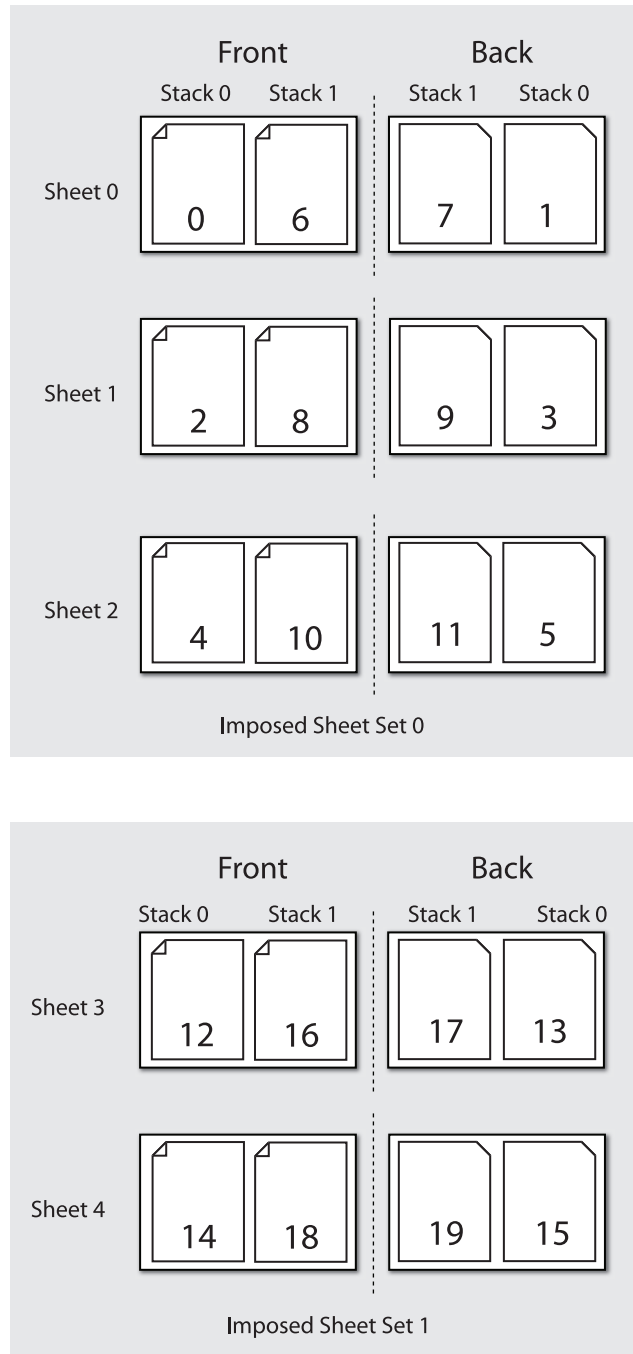

6.3.18.4.2 Imposition for Signatures with Saddle Stitching

Saddle stitched booklets typically contain pages selected from the front of the reader ordered list of pages and pages selected from the back of the reader ordered list of pages on the same sheet. For instance the outside cover of a 16 page booklet will contain the first page (`@Ord = "0"`) on the right of the sheet and the last page (`@Ord = "15"`) on the left of the sheet. The pagination for the inner sheets is calculated by adding to the page number from the front and by subtracting from the back. The next page inside the cover of a booklet printed in duplex will typically contain the third page (`@Ord = "2"`) on the right and the third from last page (`@Ord = "13"`) on the left. This behavior is described by specifying negative `@Ord` values for the `ContentObject` elements that are filled with pages from the back of the `RunList` in automated imposition. The following code illustrates how absolute `@Ord` values are assigned based on sheet iterations.

Note: `Layout/@MaxCollect` specifies the maximum number of sheets per signature (e.g., in a perfect bound book). `@MaxCollect` specifies the maximum number of loops prior to restarting the signature.

Example 6.6: Automated Imposition: Ord Values

```

/*
 * calculates a "real" ord value in an automated layout
 */

```



```

* @param ord the Value of Ord in the layout
* @param nPages the total number of pages that are consumed by the Layout, if
*   frontOffset!=0 the pages before frontOffset are NOT counted
* @param loop which sheet loop are we on?
* @param maxOrdFront number of pages consumed from the front of the list
* @param maxOrdBack positive number of pages consumed from the back of the list
* @param frontOffset page number of the first page to be placed on ord 0 in loop 0
* @return the pge to assign in this Ord, -1 if no page fits
*/

public static int calcOrd(
    int ord, int nPages, int loop, int maxOrdFront,
    int maxOrdBack, int frontOffset)
{
    final int maxOrd = maxOrdFront + maxOrdBack;
    if (maxOrd*loop >= nPages)
    {
        return -1; // we are in a loop that has no remaining pages
    }
    int page;
    if (ord >= 0)
    { // count from front
        page = ord + loop*maxOrdFront;
    } else { // the page to put on -1
        int end = nPages + maxOrd - 1 - ((nPages + maxOrd - 1)%maxOrd);
        page = end - loop*maxOrdBack+ord;
    }
    // if a page evaluates to e.g. 10 and we only have 9 pages, ciao
    return page < nPages? page+frontOffset : -1;
}

```

6.3.18.4.3 Selecting from Multiple Imposition Templates When Processing an unstructured PDL

In this case, the imposition engine optionally selects between ▶ Imposition Templates based on the quantity of pages present in the ▶ Page Pool:

Layout/@OrdsConsumed restricts the pages of a ▶ Page Pool to which a given ▶ Imposition Template of an automated layout is applied. It is designed for use with ▶ Unstructured PDLs that only allow access to pages by index. For instance, a wraparound cover might be specified as page 0 and therefore a special cover sheet with only one **ContentObject** can be defined whereas the body sheets might contain 2 **ContentObject** elements per surface.

@OrdsConsumed is only used when you have one ▶ Page Pool and you want to restrict the number of pages to be processed for a given ▶ Imposition Template.

6.3.18.4.4 Imposition for Start of a Chapter

The **Layout/PageCondition** element may be used to specify where on a sheet a first page of a chapter (▶ Page Pool) starts. It does this by specifying which **ContentObject** elements on a sheet may not be used to place the first page of a chapter. An example may be found after ▶ Table 8.152 PageCondition Element.

6.3.18.4.5 Imposition for Regenerating Sheet Surfaces

There are two methods to configure the imposition engine for re-imposing sheet surfaces:

- 1 **Re-imposition by sheet or sheet surface:** A specific selection of sheets or surfaces imposed by the imposition engine may be selected using the controls of the **RunListLink** to the **RunList (Surface)** output from the **Imposition** process.
- 2 **Re-imposition of sheets from content:** Alternatively the **RunListLink** to the **RunList (Document)** input to the imposition engine may be partitioned to select specific content to be re-imposed.

For example, if the **@Metadata0** partition key has been configured to represent a recipient record number in a VDP job, that partition keys can be used to select a specific recipient record(s) for which to re-impose sheet surfaces.

Details on how to configure **ResourceLink/Part** elements for sheet re-imposition including how to correctly regenerate dynamic sheet marks may be found at ▶ Section 3.10.7 Linking to Resources and **@IgnoreContext** in ▶ Table 8.240 RunList Resource.

6.3.18.4.6 Imposition for Document-Major Processing of a VDP ▶ Structured PDL

To process a ▶ Structured PDL in ▶ Document Major Processing Order, the **RunList (Document)** input **ResourceLink** SHALL contain **Part** elements specifying the order in which documents SHALL be processed. This effects a virtual reordering of the content present in the PDL. Details on how to configure **ResourceLink/Part** elements for content reordering may be found at ▶ Section 3.10.7 Linking to Resources and **@IgnoreContext** in ▶ Table 8.240 RunList Resource.

6.3.19 InkZoneCalculation

The **InkZoneCalculation** process takes place in order to preset the ink zones before printing. The **Preview** data are used to calculate a coverage profile that represents the ink distribution along and perpendicular to the ink zones within the printable area of the preview. The **InkZoneProfile** can be combined with additional, vendor-specific data in order to preset the ink zones and the oscillating rollers of an offset printing press.

Table 6.50: InkZoneCalculation – Input Resources

NAME	DESCRIPTION
InkZoneCalculationParams ? Modified in JDF 1.3	Specific information about the printing press geometry (e.g., the number of zones) to calculate the InkZoneProfile .
Layout ? New in JDF 1.1	Specific information about the Media (including type and color) and about the sheet (placement coordinates on the printing cylinder).
Preview	A low to medium resolution bitmap file representing the content to be printed.
Sheet ? Deprecated in JDF 1.1	Specific information about the Media (including type and color) and about the sheet (placement coordinates on the printing cylinder). Replaced by Layout in JDF 1.1.
TransferCurvePool ?	Function to apply ContactCopying DigitalPrinting and ConventionalPrinting process characteristics (e.g., press, climate and substrate) under certain standardized circumstances. This function can be used to generate an accurate InkZoneProfile .

Table 6.51: InkZoneCalculation – Output Resources

NAME	DESCRIPTION
InkZoneProfile	InkZoneProfile contains information about ink coverage along and perpendicular to the ink zones for a specific press geometry.

6.3.20 Interpreting

The interpreting device consumes page descriptions and instructions for controlling the marking device (e.g., imagesetter, digital printers, CTP, digital printing combined processes, etc.). The parsing of graphical content in the page descriptions produces a canonical display list of the elements to be drawn on each page.

The interpreter SHALL act upon any device control instructions that affect the physical functioning of the marking device such as media selection and page delivery and implied **ColorSpaceConversion**. **Media** selection determines which type of medium is used for printing and where that medium can be obtained. Page delivery controls the location, orientation and quantity of physical output.

The interpreter is also responsible for resolving all system resource references. This includes handling font substitutions and dealing with resource aliases. However, the interpreter specifically does not get involved with any functions of the device that could be considered finishing features, such as stapling, duplexing and collating.

Table 6.52: Interpreting – Input Resources

NAME	DESCRIPTION
ColorantControl ? Modified in JDF 1.1	Identifies the color model used by the job.
FontPolicy ?	Describes the behavior of the font machinery in absence of requested fonts.
InterpretingParams	Provides the parameters needed to interpret the PDL pages specified in the RunList resource.
PDLResourceAlias *	These resources allow a JDF to reference resources which are defined in a Page Description Language (PDL). For example, a PDLResourceAlias resource could refer to a font embedded in a PostScript file.
RunList	This resource identifies a set of PDL pages or surfaces that SHALL be interpreted.

Table 6.53: Interpreting – Output Resources

NAME	DESCRIPTION
InterpretedPDLData ? Deprecated in JDF 1.2	Pipe of streamed data which represents the results of Interpreting the pages in the RunList . In JDF 1.2 and beyond, a RunList with InterpretedPDLData subelements describes the output content data for Interpreting .
RunList ? New in JDF 1.2	Pipe of streamed data that represents the results of Interpreting the pages in the RunList . The data is specified in InterpretedPDLData subelements. The format and detail of these is implementation specific. In general, it is assumed that the Interpreting and Rendering processes are tightly coupled and that there is no value in attempting to develop a general specification for the format of this data.

6.3.21 LayoutElementProduction

This process describes the creation of page elements. It also explains how to create a layout that can put together all of the necessary page elements, including text, bitmap images, vector graphics, PDL or application files such as Adobe In-Design®, Adobe PageMaker® and Quark XPress®. The elements might be produced using any of a number of various software tools. This process is often performed several times in a row before the final [LayoutElement](#), representing a final layout file, is produced.

Table 6.54: LayoutElementProduction – Input Resources

NAME	DESCRIPTION
LayoutElement *	Metadata about the PDL or application file, bitmap image file, text file, vector graphics file, etc.
LayoutElementProductionParams ? New in JDF 1.3	The parameters for the LayoutElementProduction process.

Table 6.55: LayoutElementProduction – Output Resources

NAME	DESCRIPTION
LayoutElement ?	A URL of the PDL or application file is produced by this process. Exactly one of LayoutElement or RunList SHALL be specified.
RunList ?	A RunList of a LayoutElement resource of <code>@ElementType "Page"</code> or <code>"Document"</code> SHALL be produced if this LayoutElementProduction task is the last process of type LayoutElementProduction . Exactly one of LayoutElement or RunList SHALL be specified.

6.3.22 LayoutPreparation

New in JDF 1.1

The [LayoutPreparation](#) process specifies the process of defining the [Layout](#) resource for the [Imposition](#) process. Note that it is possible to create a combined process that includes both [LayoutPreparation](#) and [Imposition](#). In this case, the [Layout](#) and [RunList \(Marks\)](#) resource would not be explicitly defined, since they are exchange resources between the two processes.

Table 6.56: LayoutPreparation – Input Resources

NAME	DESCRIPTION
LayoutPreparationParams	Set of parameters needed to control the LayoutPreparation process.
RunList (Document) ? Modified in JDF 1.2	List of documents and/or pages that will be input into the layout. Note that this RunList is for information only and not modified by the LayoutPreparation process.
RunList (Marks) ?	List of marks that will be input into the layout. These are typically printer's marks such as fold marks, cut marks, punch marks or color bars.

Table 6.57: LayoutPreparation – Output Resources

NAME	DESCRIPTION
Layout	The layout of the document to be imposed.
RunList (Marks) ?	List of marks that SHALL be used as input of the following Imposition process.
TransferCurvePool ?	Definition of the transfer curves and coordinate systems of the devices.

6.3.23 LayoutShifting

New in JDF 1.4

LayoutShifting specifies how to apply separation dependent shifts on a flat or objects on a press sheet.

The exact ordering of the process within the **RIPing** and **ImageSetting** and the elements referenced by input and output **RunList** elements are not defined by the specification since it is implementation dependent. **LayoutShifting** MAY occur on display lists, raster data or in the image setting hardware.

Table 6.58: LayoutShifting – Input Resources

NAME	DESCRIPTION
LayoutShift	Parameters for the LayoutShifting .
RunList	References the input objects/flats to apply shifting to.

Table 6.59: LayoutShifting – Output Resources

NAME	DESCRIPTION
RunList	The output RunList references the image data that the separation dependent layout shifts applied to.

6.3.24 PageAssigning

New in JDF 1.4

This process sorts the possibly-unordered pages from one or more input **RunList** resources into reader's order and places the result in the output **RunList**.

Table 6.60: PageAssigning – Input Resources

NAME	DESCRIPTION
PageAssignParams ?	Container for future or proprietary extensions.
RunList +	One or more RunList resources with potentially unsorted pages

Table 6.61: PageAssigning – Output Resources

NAME	DESCRIPTION
RunList	RunList with pages sorted in reader's order so that it can be input to an Imposition process (i.e., the sequence of pages in RunList corresponds to Layout/ContentObject/@Ord).

6.3.25 PDFToPSConversion

The **PDFToPSConversion** process controls the generation of PostScript from a single PDF document. This process MAY be used at any time in a host-based PDF workflow to exit to PostScript for use of tools that consume such data. Additionally, it MAY be used to actively control the physical printing of data to a device that consumes PostScript data. The **JDF** model of this MAY include a **PDFToPSConversion** process in a combined process node with a **PDFToPSConversion** process.

It is RECOMMENDED to replace **PDFToPSConversion** with the combination of **Interpreting** and **PDLCreation** processes.

Table 6.62: PDFToPSConversion – Input Resources

NAME	DESCRIPTION
PDFToPSConversionParams	Set of parameters needed to control the generation of PostScript.
RunList	List of documents and pages to be converted to PostScript.

Table 6.63: PDFToPSConversion – Output Resources

NAME	DESCRIPTION
RunList	Stream or streams of resulting PostScript code. This PostScript code can end up physically stored in a file or be piped to another process. PDFToPSConversionParams/@GeneratePageStreams determines whether there is a single stream generated for all pages in the RunList or whether each page is generated in to a separate consecutive stream.

6.3.26 PDLCreation

New in JDF 1.3

The **PDLCreation** device consumes the display list of graphical elements generated by an **Interpreting**, **RasterReading** or a **ByteMap** and produces a new PDL output [RunList](#) based on the selected output resource parameters.

Table 6.64: PDLCreation – Input Resources

NAME	DESCRIPTION
ImageCompressionParams?	This resource provides a set of controls that determines how images will be compressed in the resulting PDL pages.
PDLCreationParams?	These parameters control the operation of the process that interprets the display list and produces the resulting PDL pages.
RunList	This resource is a pipe of streamed data that represents a device independent display list structure. The RunList SHALL specify either an InterpretedPDLData or ByteMap element, but not both.

Table 6.65: PDLCreation – Output Resources

NAME	DESCRIPTION
RunList	This resource identifies the location of the resulting PDL file(s). If the FileSpec/@MimeType is specified, then the value SHALL match PDLCreationParams/@MimeType . If not specified, then PDLCreationParams/@MimeType SHALL be inserted.

6.3.27 Preflight

Preflighting is the process of examining the components of a print job to ensure that the job will print successfully and with the expected results. Preflight checks can be performed on each document or page identified within the associated [RunList](#).

Preflighting a file is generally a two-step process. First, the documents are analyzed and compared to the set of tests. Then, a preflight report is built to list the encountered issues (according to the tests).

Agents record the instructions for, and devices record the results of, preflight operations in **JDF** jobs, using two types of resources: [PreflightParams](#) and [PreflightReport](#).

Table 6.66: Preflight – Input Resources (Sheet 1 of 2)

NAME	DESCRIPTION
PreflightParams	A specified list of tests against which documents and/or pages are to be tested.

Table 6.66: Preflight – Input Resources (Sheet 2 of 2)

NAME	DESCRIPTION
PreflightReportRulePool ? Modified in JDF 1.4	A list of rules used to build the PreflightReport . Those rules are attached to actions in the ActionPool . Modification Note: Starting with JDF 1.4, this resource becomes optional.
RunList	The list of documents and/or pages to be preflighted.

Table 6.67: Preflight – Output Resources

NAME	DESCRIPTION
PreflightReport	PreflightReport is a container for logging information that is generated by the Preflight process.

6.3.28 PreviewGeneration

The [PreviewGeneration](#) process produces a low resolution [Preview](#) of each separation that will be printed. The [Preview](#) can be used in later processes such as [InkZoneCalculation](#). The [PreviewGeneration](#) process typically takes place after [Imposition](#) or [RIPing](#).

The [PreviewGeneration](#) can be performed in one of the following two ways: 1) the imaged printing plate is scanned by a conventional plate scanner or 2) medium to high resolution digital data are used to generate the [Preview](#) for the separation(s). The extent of the PDL coordinate system (as specified by the [MediaBox](#) attribute, the resolution of the preview image, and width and height of the image) SHALL fulfill the following requirements:

MediaBox-width / 72 * x-resolution = width ± 1

MediaBox-height / 72 * y-resolution = height ± 1

A gray value of 0 represents full ink, while a value of 255 represents no ink (see the DeviceGray color model in ▶ [PostScript] Chapter 4.8.2).

6.3.28.1 Rules for the Generation of the Preview Image

To be useful for the ink consumption calculation, the preview data SHALL be generated with an appropriate resolution. This means not only spatial resolution, but also color or tonal resolution. Spatial resolution is important for thin lines, while tonal resolution becomes important with large areas filled with a certain tonal value. The maximum error caused by limited spatial and tonal resolution SHOULD be less than 1%.

6.3.28.2 Spatial Resolution

Where pixels of the preview image fall on the border between two zones, their tonal values SHALL be split up. In a worst case scenario, the pixels fall just in the middle between a totally white and a totally black zone. In this case, the tonal value is 50%, but only 25% contributes to the black zone. With the resolution of the preview image and the zone width as variables, the maximum error can be calculated using the following equation:

$$\text{error}[\%] = \frac{100}{4 \times \text{resolution}[\text{L}/\text{mm}] \times \text{zone_width}[\text{mm}]}$$

For a zone width broader than 25 mm, a resolution of 2 lines per mm will always result in an error less than 0.5%. Therefore, a resolution of 2 lines per mm (equal to 50.8 dpi) is suggested.

Figure 6-2: Worst case scenario for area coverage calculation

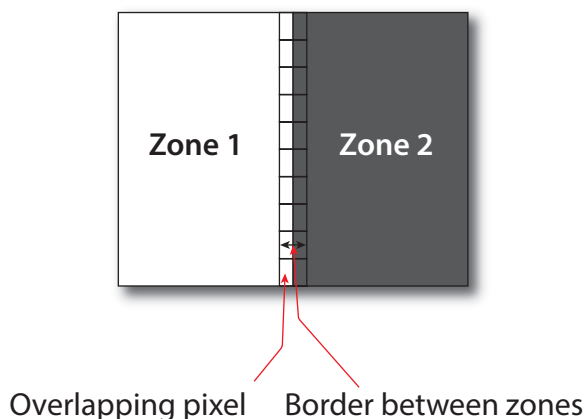

6.3.28.3 Tonal Resolution

The kind of error caused by color quantization depends on the number of shades available. If the real tonal value is rounded to the closest (lower or higher) available shade, the error can be calculated using the following equation:

$$\text{error}[\%] = \frac{100}{2 \times \text{number_of_shades}}$$

Therefore, at least 64 shades SHOULD be used.

6.3.28.4 Line Art Resolution

When rasterizing line art elements, the minimal line width is 1 pixel, which means 1/resolution. Therefore, the relationship between the printing resolution and the (spatial) resolution of the preview image is important for these kind of elements. In addition, a specific characteristic of PostScript RIPs adds another error: within PostScript, each pixel that is touched by a line is set. Tests with different PostScript jobs have shown that a line art resolution of more than 300 dpi is normally sufficient for ink-consumption calculation.

6.3.28.5 Conclusion

There are quite a few different ways to meet the requirements listed above. The following list includes several examples:

- The job can be RIPed with 406.4 dpi monochrome.
- With anti-aliasing, the image data can be filtered down by a factor of 8 in both directions. This results in an image of 50.8 dpi with 65 color shades.
- High resolution data can also be filtered using anti-aliasing. First, the RIPed data, at 2540 dpi monochrome, are taken and filtered down by a factor of 50 in both directions. This produces an image of 50.8 dpi with 2501 color shades. Finally those shades are mapped to 256 shades, without affecting the spatial resolution.

Rasterizing a job with 50.8 dpi and 256 shades of gray is not sufficient. The problem in this case is the rendering of thin lines (see Line Art Resolution above).

6.3.28.6 Recommendations for Implementation

The following three guidelines are strongly RECOMMENDED:

- The resolution of RIPed line art SHOULD be at least 300 dpi.
- The spatial resolution of the preview image SHOULD be approximately 20 pixel/cm (= 50.8 dpi).
- The tonal resolution of the preview image SHOULD be at least 64 shades.

Table 6.68: PreviewGeneration – Input Resources (Sheet 1 of 2)

NAME	DESCRIPTION
<p>ColorantControl ? New in JDF 1.1</p>	<p>The ColorantControl resources that define the ordering and usage of inks in print modules. Needed for generating thumbnails.</p>
<p>ExposedMedia ?</p>	<p>The PreviewGeneration process can use an exposed printing plate to produce a Preview resource. This task is performed using an analog plate-scanner. Exactly one of ExposedMedia, Preview or RunList SHALL be specified in any PreviewGeneration process.</p>

Table 6.68: PreviewGeneration – Input Resources (Sheet 2 of 2)

NAME	DESCRIPTION
Preview ? New in JDF 1.1	Medium or low resolution bitmap file that can be used for calculation of overviews and thumbnails. Exactly one of ExposedMedia , Preview or RunList SHALL be specified in any PreviewGeneration process.
PreviewGenerationParams	Parameters specifying the size and the type of the preview.
RunList ?	High resolution bitmap data are consumed by the PreviewGeneration process. These data represent the content of a separation that is recorded on a printing plate or other such item. Exactly one of ExposedMedia , Preview or RunList SHALL be specified in any PreviewGeneration process.
TransferCurvePool ? New in JDF 1.1	Area coverage correction and coordinate transformations of the device.

Table 6.69: PreviewGeneration – Output Resources

NAME	DESCRIPTION
Preview	The Preview data are comprised of low to medium resolution bitmap files representing, for example, the content of a separation that is recorded on a printing plate or other such item. A Preview can also be used to visualize resources, such as thumbnail images.

6.3.29 Proofing

Deprecated in JDF 1.2

The **Proofing** process was deprecated in **JDF 1.2**. Instead, use a combined process to produces the hard proof (e.g., one that includes the **ImageSetting**, **ConventionalPrinting** or **DigitalPrinting** process). Then input the hard proof to a separate **Approval** process. In **JDF 1.2** and beyond, proofing is a combined process.

6.3.30 PSToPDFConversion

This section defines the controls needed to invoke a device that accepts a PostScript stream and produces a set of PDF pages as output.

It is RECOMMENDED to replace **PSToPDFConversion** with the combination of **Interpreting** and **PDLCreation** processes.

Table 6.70: PSToPDFConversion – Input Resources

NAME	DESCRIPTION
FontParams ?	These parameters determine how the conversion process will handle font errors encountered in the PostScript stream.
ImageCompressionParams ?	This resource provides a set of controls that determines how images will be compressed in the resulting PDF pages.
PSToPDFConversionParams ?	These parameters control the operation of the process that interprets the PostScript stream and produces the resulting PDF pages.
RunList	This resource specifies where the PostScript stream SHALL be found.

Table 6.71: PSToPDFConversion – Output Resources

NAME	DESCRIPTION
RunList	This resource identifies the location of the resulting PDF pages.

6.3.31 RasterReading

New in JDF 1.3

The **RasterReading** process consumes raster graphic formatted files and converts them into a display list structure as the principal element to be drawn on each page. The **RasterReading** process is not a stand-alone process but is used in conjunction with processing and rendering processes in a combined process such as **Rendering** or **PDLCreation**.

Table 6.72: RasterReading – Input Resources

NAME	DESCRIPTION
RasterReadingParams ?	Additional parameters for reading raster files.
RunList	This resource identifies a set of raster pages or surfaces that will be inserted into the display list. This resource SHALL reference ByteMap images.

Table 6.73: RasterReading – Output Resources

NAME	DESCRIPTION
RunList	Pipe of streamed data that represents the results of RasterReading the pages in the input RunList . The format and detail are implementation dependent. The RunList SHALL specify an InterpretedPDLData element that describes the output content data for RasterReading .

6.3.32 Rendering

The [Rendering](#) process consumes the display list of graphical elements generated by the [Interpreting](#) or [RasterReading](#) process. It converts the graphical elements according to the geometric and graphic state information contained within the display list and with the [RenderingParams](#) information to produce binary rasterized data suitable for processes that consume [ByteMap](#) information.

Table 6.74: Rendering – Input Resources

NAME	DESCRIPTION
ImageCompressionParams ? New in JDF 1.5	Allows definition of compressed raster images.
InterpretedPDLData ? Deprecated in JDF 1.2	Pipe of streamed data that represents the results of Interpreting the pages in the RunList . In JDF 1.2 and beyond, a RunList/InterpretedPDLData subelement describes the input content data for Rendering .
Media ? Deprecated in JDF 1.1	This resource provides a description of the physical media that will be marked. The physical characteristics of the media can affect decisions made during Rendering .
RenderingParams ?	This resource describes the format of the byte maps to be created and other specifics of the Rendering process.
RunList ? New in JDF 1.2	Pipe of streamed data that represents the results of Interpreting or RasterReading the pages in the input RunList . The data is specified in InterpretedPDLData subelements. The format and detail of these is implementation specific. In general, it is assumed that the Interpreting , RasterReading , Rendering and PDLCreation are tightly coupled and that there is no value in attempting to develop a general specification for the format of this data. Modification note: Starting with JDF 1.4 , all text replaced by text from RunList in output resource

Table 6.75: Rendering – Output Resources

NAME	DESCRIPTION
RunList	Pipe of streamed data that represents the results of Rendering . This RunList MAY be consumed by any subsequent process that consumes raster data, including PDLCreation , ImageSetting or DigitalPrinting . The data MAY be specified in ByteMap sub-elements. In general, it is assumed that the Interpreting , RasterReading , Rendering and PDLCreation are tightly coupled and that there is no value in attempting to develop a general specification for the format of this data. Modification note: Starting with JDF 1.4 , first half of text is modified.

6.3.33 RIPing

RIPing is a Gray Box (see ▶ Section 3.3.2.1 Use of the Types Attribute in Process Group Nodes – Gray Boxes) that is a combination of at least two processes. Most often it includes **Interpreting** and **Rendering**, but it may also include **ColorSpaceConversion**, **Trapping**, **Separation**, **Imposition** and **Screening**. Thus one typical **RIPing** node is with **JDF/@Type** = "ProcessGroup" and **JDF/@Category** = "RIPing" as shown in the following example:

Example 6.7: RIPing

```
<JDF Category="RIPing" ID="ID100" JobPartID="ID23" Status="Ready"
  Type="ProcessGroup" Types="Interpreting Rendering Screening"
  Version="1.6" xmlns="http://www.CIP4.org/JDFSchema_1_1"/>
```

The **RIPing** process consumes page descriptions and instructions for producing graphical output. It parses the graphical content in the page descriptions, renders that content, and produces a rasterized image of the page. This raster MAY contain contone data and be represented upon output as a **ByteMap**. Alternatively, the **RIPing** process MAY also perform halftone screening, in which case the output is in the form of a bitmap. It is also responsible for resolving all system resource references that include font handling and resource aliasing.

Instructions read by the RIP include information about the media, halftoning, color transformations, colorant controls and other items that affect that rasterized output. They do not, however, represent any specific controls for the physical output device, nor do they deal with any instructions intended for the finishing device.

In most cases, RIPing will be part of a combined process with a process that specifies physical marking (e.g., **DigitalPrinting** or **ImageSetting**). In this case, the interpreter SHOULD be able to act upon device control instructions that affect the physical functioning of the printing device such as media selection and page delivery. **Media** selection determines which type of medium is used for marking and where that medium can be obtained. Page delivery controls the location, orientation and quantity of physical output. The RIP is also responsible for resolving all system resource references. This includes handling font substitutions and dealing with resource aliases. However, the RIP specifically does not get involved with any functions of the device that could be considered finishing features, such as stapling, duplexing and collating.

When a **RIPing** process is comprised of only the **Interpreting** and **Rendering** processes, various intermediary steps are needed before the output can be run through a **ConventionalPrinting** process. In theory, however, a workflow could include no intermediary steps between a **RIPing** process and a **DigitalPrinting** process. The following workflow scenarios represent possible process chains in each circumstance:

RIPing → **Screening** → **ImageSetting** → **ContactCopying** → **ConventionalPrinting**

RIPing → (**Screening**) → **DigitalPrinting**

Since **RIPing** is not a predefined **JDF** process, see the processes that contribute to the RIP for input and output resources.

6.3.34 Scanning

The **Scanning** process creates bitmaps from analog images using a scanner.

Table 6.76: Scanning – Input Resources

NAME	DESCRIPTION
ExposedMedia	Description of the media to be scanned. The ExposedMedia SHOULD be partitioned by @RunIndex , in order to provide unique mapping from ExposedMedia to the output RunList .
ScanParams	High level scanner settings. These settings are specifically not intended as a replacement for low-level device interfaces such as TWAIN.

Table 6.77: Scanning – Output Resources

NAME	DESCRIPTION
RunList	List of a ByteMap resource or a LayoutElement resource of @ElementType = "Image".

6.3.35 Screening

This process specifies the process of halftone screening. It consumes contone raster data (e.g., the output from an **Interpreting** and **Rendering** process). It produces monochrome that has been filtered through a halftone screen to identify which pixels are needed for approximating the original shades of color in the document.

This process definition includes capabilities for halftoning after raster image processing according to the PostScript definitions. Alternatively, it allows for the selection of FM screening/error diffusion techniques. In general, an actual screening process will be a combined process of **ContoneCalibration** and **Screening** processes.

Table 6.78: Screening – Input Resources

NAME	DESCRIPTION
RunList	Ordered list of rasterized ByteMap or InterpretedPDLData representing pages or surfaces.
ScreeningParams	Parameters specifying which halftone mechanism SHALL be applied and with what specific controls.

Table 6.79: Screening – Output Resources

NAME	DESCRIPTION
RunList	Ordered list of rasterized and screened output pages. The resolution SHALL remain the same, with resulting data being one bit per component. Furthermore, the organization of planes within the data SHALL not change.

6.3.36 Separation

The **Separation** process specifies the controls associated with the generation of color-separated data. It is designed to be flexible enough to allow a variety of possible methods for accomplishing this task. First of all, it sponsors host-based PDF separating operations, in which a **RunList** of pre-separated PDF data is generated. It can also be combined with a RIP to allow control of In-RIP separations. In this scenario a **RunList** containing **ByteMap** resources is generated as the output. Yet another anticipated combination is with the process that deals with incoming device-dependent data. And finally, it MAY be part of a combined process with an **ImageReplacement** process in order to do image substitution for omitted or proxy images.

Table 6.80: Separation – Input Resources

NAME	DESCRIPTION
ColorantControl ? Modified in JDF 1.1A	Identifies which colorants in the job are to be output.
RunList	List of pages that are to be operated on.
SeparationControlParams	Controls for the separation process.

Table 6.81: Separation – Output Resources

NAME	DESCRIPTION
RunList	List of separated pages or separated raster bytemaps.

6.3.37 ShapeDefProduction

New in JDF 1.4

This process describes the structural design of a one-up product (e.g., a non rectangular label, a box, a display, a bag, a pouch, etc.). This is a description of the unprinted blank box as it will be available after **ShapeCutting** and before **BoxFolding**. Also, this process typically (but not exclusively) describes the process of designing the shape of a new box using a CAD application. See **DieLayoutProduction** for the process of designing a die for multiple one-up products. The output of the **ShapeDefProduction** process can be multiple **ShapeDef** resources (e.g., when the design of the box results in multiple pieces, such as a box, an object and an insert piece, where the insert piece is fixed to the object to be packed in the box). Another example would be a multi-piece display. The **ShapeDefProduction** process can be performed by a human operator using a CAD application. In some cases it can be an automated process.

Note: **ShapeDefProduction** needs information stored in both **ShapeDefProductionParams** and **ShapeDef** to make a new structural design.

Table 6.82: ShapeDefProduction – Input Resources

NAME	DESCRIPTION
LayoutElement ?	A rough drawing or outline (e.g., an EPS) of the ShapeDef that serves as the input for structural design.
ShapeDefProductionParams	Parameters for the structural design.

Table 6.83: ShapeDefProduction – Output Resources

NAME	DESCRIPTION
ShapeDef +	A resource describing the shape of the product to be produced.

6.3.38 SheetOptimizing

New in JDF 1.5

[SheetOptimizing](#) describes ganging of multiple [BinderySignatures](#) onto one or more printed sheets. These [BinderySignatures](#) MAY be parts of unrelated customer jobs. This process is also referred to as job ganging.

[SheetOptimizing](#) MAY be used together with [QueueSubmissionParams/@GangName](#) and the [ForceGang](#) command. In this case, individual jobs with identical [QueueSubmissionParams/@GangName](#) are collected with each job submission. A [ForceGang](#) command instructs the ganging engine to process the waiting [GangInfo](#) elements.

Table 6.84: SheetOptimizing – Input Resources

NAME	DESCRIPTION
Assembly *	Input Assembly to specify the binding order e.g. for creep calculation. These assemblies MAY contain sections that are not included in this sheet optimization (e.g., when only covers are optimized and the bodies are produced individually).
BinderySignature ?	List of BinderySignature elements that describe the individual gang candidate signatures. This BinderySignature SHALL at least be partitioned by @BinderySignatureID .
SheetOptimizingParams ?	Parameters specifying details that allow individual sections to be distributed on the printed sheets.

Table 6.85: SheetOptimizing – Output Resources

NAME	DESCRIPTION
StrippingParams	The StrippingParams resource that will be populated by the SheetOptimizing process. The resource MAY be partially populated by the submitter with restrictions on what the SheetOptimizing is allowed to do.

6.3.39 SoftProofing

Deprecated in JDF 1.2

The [SoftProofing](#) process was deprecated in **JDF 1.2**. Instead, use a combined process to produce the soft proof in which the last process is the [Approval](#) process that approves the soft proof. In **JDF 1.2** and beyond, soft proofing is a combined process.

6.3.40 Stripping

New in JDF 1.2

An important aspect of the interface between an MIS system and a prepress workflow system is imposition. When an order is accepted or even during the estimation phase, the MIS system determines how the product will be produced using the available equipment (e.g., presses, folders, cutters, etc.) in the most cost-efficient way. The result of this exercise has a large impact on imposition in prepress.

The [Stripping](#) process specifies the process of translating a high level structured description of the imposition of one or multiple job parts or part versions represented by the [StrippingParams](#) resource into a [Layout](#) resource for the [Imposition](#) process. Note that the [Stripping](#) process can generate all resources needed for the [Imposition](#) process, thus also the [RunList](#) ([Marks](#)).

The **Assembly** resource is often referred to as the product view, while the **BinderySignature** is referred to as the production view. In this way, **Assembly/@BindingSide** typically refers to the bound side of the final product, while **BinderySignature/@BindingEdge** refers to the bound side during production.

When both attributes are not equal, it is up to the stripping device to modify the orientation and/or sequence of the content pages to synchronize product and production view.

Table 6.86: Stripping – Input Resources

NAME	DESCRIPTION
Assembly +	Assembly describes how the sections of the different job parts imposed together are combined. If multiple Assembly resources are defined, mapping between StrippingParams and Assembly is achieved by matching the respective @JobID and @AssemblyIDs attributes.
BinderySignature ?	List of BinderySignature elements that describe the individual signatures that are combined to produce a final product. This BinderySignature SHALL at least be partitioned by @BinderySignatureID .
ColorantControl ? New in JDF 1.3	Contains information on the colors and separations. Useful when creating marks that need color information.
RunList (Document) ?	List of documents. When available, this list can be used to generate a Layout and populated RunList (no LayoutElement [@ ElementType = "Reservation"]) which can be fed into a subsequent Imposition process.
StrippingParams	High level structured description of the imposition of one or multiple job parts or part versions.
TransferCurvePool ?	Definition of the transfer curves and coordinate systems of the devices. The coordinate system of the StrippingParams coincides with the Layout coordinate system specified in the TransferCurvePool .

Table 6.87: Stripping – Output Resources

NAME	DESCRIPTION
Layout	The layout of the document to be imposed.
RunList (Document) ?	List of documents that are to be used as input of the following Imposition process.
RunList (Marks) ?	List of marks that are to be used as input of the following Imposition process.

Example 6.8: Stripping: Simple Example

This simple example specifies three 16 page bindery signatures using folding catalog scheme F16-6.

```
<StrippingParams ID="FoldCatalogSample" Class="Parameter" Status="Available"
  WorkStyle="WorkAndBack" PartIDKeys="SheetName">
  <BinderySignature FoldCatalog="F16-6"/>
  <StrippingParams SheetName="Sheet1"/>
  <StrippingParams SheetName="Sheet2"/>
  <StrippingParams SheetName="Sheet3"/>
</StrippingParams>
```

Example 6.9: Stripping: Complex Example

The following example specifies three sheets: *Sheet1* and *Sheet2* are based on a B2x4 **BinderySignature** using the "WorkAndBack" workstyle, while *Sheet3* is based on **BinderySignature** B2x2 using the "WorkAndTurn" workstyle.

WorkAndBack B2x4

8	7	4	11
15	0	3	12

WorkAndTurn B2x2

4	3	2	5
7	0	1	6

```
<BinderySignature Class="Parameter" ID="B2x4" NumberUp="4 2" Status="Available">
  <SignatureCell BackPages="14 1 2 13" FrontPages="15 0 3 12" Orientation="Up"/>
  <SignatureCell BackPages="9 6 5 10" FrontPages="8 7 4 11" Orientation="Down"/>
</BinderySignature>
<BinderySignature Class="Parameter" ID="B2x2" NumberUp="2 2" Status="Available">
  <SignatureCell BackPages="6 1" FrontPages="7 0" Orientation="Up"/>
  <SignatureCell BackPages="5 2" FrontPages="4 3" Orientation="Down"/>
</BinderySignature>
<StrippingParams Class="Parameter" ID="L1" PartIDKeys="SheetName"
  Status="Available" WorkStyle="WorkAndBack">
  <StrippingParams SheetName="Sheet1">
    <BinderySignatureRef rRef="B2x4"/>
  </StrippingParams>
  <StrippingParams SheetName="Sheet2">
    <BinderySignatureRef rRef="B2x4"/>
  </StrippingParams>
  <StrippingParams SheetName="Sheet3" WorkStyle="WorkAndTurn">
    <BinderySignatureRef rRef="B2x2"/>
    <Position RelativeBox="0 0 0.5 1"/>
    <Position Orientation="Flip180" RelativeBox="0.5 0 1 1"/>
  </StrippingParams>
</StrippingParams>
```

6.3.41 Tiling

The **Tiling** process allows the contents of surfaces to be imaged onto separate pieces of media. Note that many different workflows are possible. **Tiling** SHALL always follow **Imposition**, but it can operate on imposed PDL page contents or on contone or halftone data. **Tiling** will generally be part of a combined process. For example, **Tiling** might be part of a combined process with **ImageSetting**. In that case, the input would be a **RunList** that contains **ByteMap** resources for each surface.

Table 6.88: Tiling – Input Resources

NAME	DESCRIPTION
RunList (Marks) ?	Structured list of incoming marks. These are typically printer’s marks that provide the information needed to combine the tiles.
RunList (Surface)	Structured list of imposed page contents or Byte Maps that are to be decomposed to produce the images for each tile. The @ <i>ElementType</i> value of the LayoutElement resource SHALL be "Surface".
Tile	A partitioned Tile resource that describes how the surface contents are to be decomposed.

Table 6.89: Tiling – Output Resources

NAME	DESCRIPTION
RunList	Structured list of portions of the decomposed surfaces. The value of the @ <i>ElementType</i> attribute of the LayoutElement resource SHALL be "Tile".

6.3.42 Trapping

Trapping is a prepress process that modifies PDL files to compensate for a type of error that occurs on presses. Specifically, when more than one colorant is applied to a piece of media using more than one inking station, the media might not stay in perfect alignment when moving between inking stations. Any misalignment will result in an error called mis-registration. The visual effect of this error is either that inks are erroneously layered on top of one another, or, more seriously, that gaps occur between inks that are intended to abut. In this second case, the color of the media is revealed in the gap and is frequently quite noticeable. **Trapping**, in short, is the process of modifying PDL files so that abutting colorant edges intentionally overlap slightly, in order to reduce the risk of gaps.

The **Trapping** process modifies a set of document pages to reduce or (ideally) eliminate visible mis-registration errors in the final printed output. The process MAY be part of a combined process with **RIPing** or specified as a stand-alone process.

Table 6.90: Trapping – Input Resources

NAME	DESCRIPTION
ColorantControl ? Modified in JDF 1.1A	Identifies the color model used by the job.
FontPolicy ? New in JDF 1.1	Describes the behavior of the font machinery in absence of requested fonts.
RunList	Structured list of incoming page contents that are to be trapped.
TrappingDetails	Describes the general settings needed to perform trapping.

Table 6.91: Trapping – Output Resources

NAME	DESCRIPTION
RunList	Structured list of the modified page contents after Trapping has been executed.

6.4 Press Processes

Press processes involve the transfer of colorant to a substrate. From a technical standpoint they are often classified in impact and non-impact printing technologies. The impact printing class can be further subdivided into relief, intaglio, planograph or screen technologies, which in turn can be divided in further subparts. Because of the way a workflow is constructed in **JDF**, however, a different approach to classification was used. All of the various printing technologies belong to one of two categories:

- 1 **ConventionalPrinting**, which involves printing from a physical master,
- 2 **DigitalPrinting**, which involves generic commercial printing from a digital master.

The **ConventionalPrinting** and **DigitalPrinting** processes can be applied to either web or sheet fed printing.

The most prominent physical, planographic printing technologies are offset lithography and electrophotography. They are also the printing processes that are most commonly used by today's graphic arts industry. Consequently, the **ConventionalPrinting** process in **JDF** takes them as models. That does not mean, however, that other printing techniques can not make use of the **ConventionalPrinting** process and its resources. The extensibility features of **JDF** can be used to fill other requirements related to printing technology.

6.4.1 ConventionalPrinting

This process covers several conventional printing tasks, including sheet-fed printing, web printing, web/ribbon coating, converting and varnishing. Typically, each takes place after prepress and before postpress processes. Direct imaging technology on press is modeled as a combined process of **ImageSetting** and **ConventionalPrinting**. Press machinery often includes postpress processes (e.g., **WebInlineFinishing**, **Folding** and **Cutting**) as in-line finishing operations. The **ConventionalPrinting** process itself does not cover these postpress tasks.

Using a conventional printing press for producing a press proof can be performed in the following two ways:

- A proof of type **Component** is produced with a **ConventionalPrinting** process. The result of this process is then sent to the **Approval** process, which in turn produces an **ApprovalSuccess** resource. That resource is then passed on to a second **ConventionalPrinting** process, which requires that the press be set up a second time.
- The **@DirectProof** attribute of the **ConventionalPrintingParams** can be used to specify the proof if it is produced during the **ConventionalPrinting** process. In this case, the press need only be set up once.

Note that the definition and ordering of separations is specified by **ColorantControl/ColorantOrder** of the appropriate resource.

In the context of web printing, the **ConventionalPrinting** process SHALL be in a combined process with the **WebInlineFinishing** process.

Table 6.92: ConventionalPrinting – Input Resources (Sheet 1 of 2)

NAME	DESCRIPTION
ColorantControl ?	The ColorantControl resources that define the ordering and usage of inks in print modules. The ColorantControl resource specifies the complete set of colors that will be printed on a sheet.
Component ? Modified in JDF 1.4	Various components in the form of preprints can be used in ConventionalPrinting in lieu of Media . Examples include waste or a set of preprinted sheets. Modification note: Starting with JDF 1.4, the input ComponentLink NEED NOT have @ProcessUsage= "Input".
Component (Proof) ?	A proof component is used if a proof was produced during an earlier print run. Note that the proof MAY be a Component produced in a previous run and has not necessarily been produced explicitly as a proof. In general, at most one of Component (Proof) or ExposedMedia (Proof) SHOULD be specified.
ConventionalPrintingParams	Specific parameters to set up the press.
ExposedMedia (Cylinder) ? New in JDF 1.3	ExposedMedia (Cylinder) is used to describe direct imaging on reusable cylinders. ExposedMedia (Cylinder) defines the set of cylinders to be used in the press run that is described by this node. Both ExposedMedia (Cylinder) and ExposedMedia (Plate) MAY occur in the same device. At least one of ExposedMedia (Cylinder) or ExposedMedia (Plate) SHALL be specified.
ExposedMedia (Plate) ? Modified in JDF 1.3	The printing plates and information about them are used to set up the press. The ExposedMedia (Plate) resource defines the set of plates to be used in the press run that is described by this node. Both ExposedMedia (Cylinder) and ExposedMedia (Plate) MAY occur in the same device. At least one of ExposedMedia (Cylinder) or ExposedMedia (Plate) SHALL be specified.
ExposedMedia (Proof) ?	A proof is used to compare color and content during ConventionalPrinting . This proof is produced by a prepress proofing device. At most one of ColorantControl (Proof) or ExposedMedia (Proof) SHOULD be specified.
ExposedMedia (Sleeve) ? New in JDF 1.4	Description of a sleeve.
Ink ? Modified in JDF 1.1	Information about the ink (e.g., brand, color) is useful to set up the press.
InkZoneProfile ?	The InkZoneProfile contains information about the amount ink that is needed along the printing cylinder of a specific printing press. It is only useful for Offset Lithography presses with ink key adjustment functions.
Layout ? New in JDF 1.1	Sheet and surface elements from the Layout tree (e.g., CIELABMeasuringField , DensityMeasuringField or ColorControlStrip) can be used for quality control at the press. The quality control field value and position can be of interest for automatic quality control systems. RegisterMark can be used to line up the printing plates for the press run, and its position can in turn be used to position items such as a camera.
Media ?	The physical substrate (e.g., paper or foil) and information about the Media (e.g., thickness, type and size) are useful in setting up paper travel in the press. This resource SHALL be present if no preprinted Component (Input) resource is used.
Media (MountingTape) ? New in JDF 1.4	Description of a mounting tape for a sleeve.
PrintCondition ? New in JDF 1.2	Used to control the use of colorants when printing pages on a specific media. The attributes and elements of the PrintCondition resource describe the aim values for a given printing process.
Sheet ? Deprecated in JDF 1.1	Specific information about the Media (including type and color) and about the sheet (e.g., placement coordinates on the printing cylinder). Replaced by Layout in JDF 1.1.

Table 6.92: ConventionalPrinting – Input Resources (Sheet 2 of 2)

NAME	DESCRIPTION
TransferCurvePool ? New in JDF 1.1	Area coverage correction and coordinate transformations of the device.

Table 6.93: ConventionalPrinting – Output Resources

NAME	DESCRIPTION
Component Modified in JDF 1.2	Describes the printed sheets, ribbons or webs that can be used by another printing process or postpress processes. Note that the <code>@Amount</code> attribute of the ResourceLink to this resource indicates the number of copies of the entire job that will be produced. Modification note: Prior to JDF 1.2 this Component was marked with a <code>@ProcessUsage = "Good"</code> , which is OPTIONAL, but supported in JDF 1.2 and beyond.
Component (Waste) ? Deprecated in JDF 1.2	Produced waste of printed sheets or ribbons. In JDF 1.2 and beyond, ConventionalPrinting produces one Component that MAY be partitioned by <code>@Condition</code> in order to distinguish waste Component resources from good Component resources.

6.4.2 DigitalPrinting

DigitalPrinting is a direct printing process that, like **ConventionalPrinting**, occurs after prepress processes but before postpress processes. In **DigitalPrinting**, the data to be printed are not stored on an extra medium (e.g., a printing plate or a printing foil), but instead are stored digitally. The printed image for each output is generated using the digital data. Electrophotography, inkjet, and other technologies are used for transferring colorant (either liquid ink or dry toner) onto the substrate. Furthermore, both Sheet-Fed and Web presses can be used as machinery for **DigitalPrinting**.

DigitalPrinting MAY also be used to image a small area on preprinted **Component** resources to perform actions such as addressing or numbering another **Component**. This kind of process can be executed by imaging with an inkjet printer during press, postpress or packaging operations. **DigitalPrinting** is therefore not only a press or prepress operation but sometimes also a postpress process.

Digital printing devices that provide some degree of finishing capabilities (e.g., collating and stapling), as well as some automated layout capabilities (e.g., N-up and duplex printing), MAY be modeled as a combined process that includes **DigitalPrinting**. Such a combined process MAY also include other processes (e.g., **Approval**, **ColorCorrection**, **ColorSpaceConversion**, **ContoneCalibration**, **Cutting**, **Folding**, **HoleMaking**, **ImageReplacement**, **Imposition**, **Interpreting**, **LayoutPreparation**, **Perforating**, **Rendering**, **Screening**, **Stacking**, **Stitching**, **Trapping** or **Trimming**).

Controls for **DigitalPrinting** are provided in the **DigitalPrintingParams** resource. The set of input resources of a combined process that includes **DigitalPrinting** MAY be used to represent an Internet Printing Protocol (IPP) Job or a PPML Job. See Application Notes for IPP and Variable Data printing.

Note: Putting a label on a product or **Droptem** is not **DigitalPrinting**; it is **Inserting**.

Table 6.94: DigitalPrinting – Input Resources (Sheet 1 of 2)

NAME	DESCRIPTION
ColorantControl ?	The ColorantControl resources that define the ordering and usage of inks in print modules.
Component * Modified in JDF 1.4	Various components can be used in DigitalPrinting instead of Media . Examples include preprinted covers, waste, precut Media , or a set of preprinted sheets or webs. If multiple Component (Input) resources are linked to one process, the mapping of media to content is defined in the partitions of DigitalPrintingParams . At least one of Component or Media SHALL be specified as input Modification note: Starting with JDF 1.4, the input ComponentLink NEED NOT have <code>@ProcessUsage = "Input"</code> .
Component (Proof) ?	A proof component is used if a proof was produced during an earlier print run (see description in ▶ Section 6.4.1 ConventionalPrinting). Note that the proof MAY be a Component produced in a previous run and has not necessarily been produced explicitly as a proof. In general, at most one of Component (Proof) or ExposedMedia SHOULD be specified.
DigitalPrintingParams	Specific parameters to set up the machinery.

Table 6.94: DigitalPrinting – Input Resources (Sheet 2 of 2)

NAME	DESCRIPTION
ExposedMedia ?	A proof is useful for comparisons (completeness, color accuracy) with the print out of the DigitalPrinting process. In general, at most one of Component (Proof) or ExposedMedia SHOULD be specified
Ink ?	Ink or toner and information that is needed for DigitalPrinting .
Layout ? New in JDF 1.1	Sheet and surface elements from the Layout tree (e.g., CIELABMeasuringField , DensityMeasuringField or ColorControlStrip) can be used for quality control at the press. The quality control field value and position can be of interest for automatic quality control systems. RegisterMark can be used to line up the printing plates for the press run, and its position can in turn be used to position items such as a camera.
Media *	The physical Media and information about the Media (e.g., thickness, type and size) is used to set up paper travel in the press. This has to be present if no preprinted Component (Input) resource is present. Unprinted Media used for covers are also defined as Media . At least one of Component or Media SHALL be specified as Input Note: Printing a job on more than one web or sheet at the same time is parallel processing.
PrintCondition ?	Used to control the use of colorants when printing pages on a specific media. The attributes and elements of the PrintCondition resource describe the aim values for a given printing process.
RunList	Raster data in Byte Maps that will be printed on the digital press are needed for DigitalPrinting . The RunList contains only ByteMap elements.
Sheet ? Deprecated in JDF 1.1	Specific information about the Media (including type and color) and about the sheet (placement coordinates on the printing cylinder). Replaced by Layout in JDF 1.1 .
TransferCurvePool ? New in JDF 1.1	Area coverage correction and coordinate transformations of the device.

Table 6.95: DigitalPrinting – Output Resources

NAME	DESCRIPTION
Component Modified in JDF 1.2	Components are produced for other printing processes or postpress processes. Note: The @Amount attribute of the ResourceLink to this resource SHALL specify the number of copies of the entire job that SHALL be produced. Prior to JDF 1.2 this Component was marked with a @ProcessUsage = "Good" , which is OPTIONAL, but supported in JDF 1.2 and beyond MAY be specified. Note: When processing a PDL with multiple documents or sets, such as PDF/VT, the amount SHALL BE defined in the scope of the entire document. If one copy of the number of copies defined within the PDL file of each record is requested, the Component/@Amount SHALL be set to 1.
Component (Waste) ? Deprecated in JDF 1.2	Produced waste, MAY be used by other processes. In JDF 1.2 and beyond, DigitalPrinting produces one Component that MAY be partitioned by @Condition in order to distinguish waste Component resources from good Component resources.

6.4.3 Varnishing

New in JDF 1.4

Varnishing is the process of varnishing a **Component**. Spot varnishing with a ripped image or a printing plate from **ExposedMedia** SHALL be described as **DigitalPrinting** or **ConventionalPrinting** with **Ink/@Family = "Varnish"**. All types of all-over (flood) varnishing or spot varnishing applied without a ripped image or a printing plate from **ExposedMedia** SHALL be described with the **Varnishing** process. Flood coatings are typically intended to be protective, they can increase water-resistance, scuff-resistance, and even food resistance in the case of restaurant menus.

Common coating types requested by customers include UV coatings (Ultra Violet cured polymers) which provide higher durability, and aqueous coatings that are viewed as greener and typically more easily recycled at end-of-life. Both types of overall coating protect the printed image as well as the substrate.

Table 6.96: Varnishing – Input Resources

NAME	DESCRIPTION
Component ?	The Component to be varnished. Exactly one of Component or Media SHALL be specified.
ExposedMedia *	Various types of ExposedMedia MAY be specified for varnishing. See VarnishingParams/@VarnishMethod for details.
Ink ?	Details of the colorant that is used for Varnishing.Ink/@Family SHOULD be " Varnish ".
Media ?	The Media to be varnished. Exactly one of Component or Media SHALL be specified.
VarnishingParams ?	Details of the setup of the varnishing device.

Table 6.97: Varnishing – Output Resources

NAME	DESCRIPTION
Component	The varnished Component .

6.4.4 IDPrinting

Deprecated in JDF 1.1

The IDPrinting process was deprecated in **JDF** 1.1. Instead, implementations SHOULD use a combined process that includes the **DigitalPrinting** process, thus improving interoperability by reducing one of the combinations of processes. Also the **IDPrinting** process defined a number of resources and subelements which are deprecated since they duplicate other resources.

6.5 Postpress Processes

Postpress is the most flexible and varied area that is covered by this specification. The individual postpress processes are provided in alphabetical order.

6.5.1 AdhesiveBinding

Deprecated in JDF 1.1

The **AdhesiveBinding** process has been split into the following individual processes:

- [CoverApplication](#)
- [Gluing](#)
- [SpinePreparation](#)
- [SpineTaping](#)

Note: The parameters of the [GlueApplication](#) for adhesive-binding operations have been moved into [CoverApplicationParams](#) and [SpineTapingParams](#) as [GlueApplication](#) subelements. The generic [GlueApplication](#) for adhesive binding is now described by the [Gluing](#) process.

6.5.2 BlockPreparation

New in JDF 1.1

As there are many options for a hardcover book, the block preparation is more complex than what has already been described for other types of binding above. Those options are the ribbon band (numbers of bands, materials and colors), gauze (material and glue), head band (material and colors), kraft paper (material and glue) and tightbacking (different geometry and measurements).

Table 6.98: BlockPreparation – Input Resources

NAME	DESCRIPTION
Component	The BlockPreparation process consumes one Component and creates a book block.
BlockPreparationParams	Specific parameters to set up the machinery.

Table 6.99: BlockPreparation – Output Resources

NAME	DESCRIPTION
Component	One Component is produced: the prepared book block. The value of Component / @ProductType SHALL be "BookBlock".

6.5.3 BoxFolding

New in JDF 1.3

BoxFolding defines the process of folding and gluing blanks into folded flat boxes for packaging.

Table 6.100: BoxFolding – Input Resources

NAME	DESCRIPTION
BoxFoldingParams	Specific parameters to set up the folder gluer.
Component	The BoxFolding process consumes one Component , the folding blank. Its @ProductType = "BlankBox".
Component (Application) * Deprecated in JDF 1.4	This process MAY consume additional Component resources, such as windows, handles or inlets. These Component resources SHALL additionally be referenced from BoxFoldingParams/BoxApplication elements. Deprecation note: Starting with JDF 1.4 , a combined process that includes the BoxFolding and Inserting processes replaces BoxApplication .

Table 6.101: BoxFolding – Output Resources

NAME	DESCRIPTION
Component	One Component is produced: the folded flat box. The value of Component / @ProductType SHALL be "FlatBox".

6.5.4 BoxPacking

New in JDF 1.1

A pile, stack or bundle of products can be packed into a box or carton.

Table 6.102: BoxPacking – Input Resources

NAME	DESCRIPTION
BoxPackingParams	Specific parameters to set up the machinery.
Component +	The BoxPacking process puts a set of Component resources into the box Component . If more than one Component is specified, a Component/Bundle resource SHALL also be specified for each Component . Modification note: Starting with JDF 1.4 , Component can occur more than once.
Component (Box) ?	Details of the box or carton.
Media (Tie) ? New in JDF 1.3	Protective Media can be placed between individual rows of Component resources.
Media (Underlay) ? New in JDF 1.3	Protective Media can be placed between individual layers of Component resources.

Table 6.103: BoxPacking – Output Resources

NAME	DESCRIPTION
Component	One Component is produced: the boxed Component .

6.5.5 Bundling

New in JDF 1.2

JDF 1.1 contains no process for bundling products. The **Bundling** process is normally followed by a **Strapping** process. In a **Bundling** process, single products like sheets or signatures are bundled together. The resulting bundle is the output **Component** of the process and is used to store the products. When this **Component** is used as an input to a consuming or subsequent process (e.g., **Gathering**, **Collecting** or **Inserting**), the single components of a bundle are used.

Figure 6-3: Bundle creation



Figure 6-4: Bundle transport



Table 6.104: Bundling – Input Resources

NAME	DESCRIPTION
BundlingParams	Bundling parameters.
Component	The Component to be bundled.
Media ?	End boards to protect the bundle. For each bundle a pair of end boards is needed.

Table 6.105: Bundling – Output Resources

NAME	DESCRIPTION
Component	The completed bundle.

6.5.6 CaseMaking

New in JDF 1.1

Case making is the process where a hardcover book case is produced. As there are many different kinds of hardcover cases, they will be described in a later version of the **JDF** specification.

Table 6.106: CaseMaking – Input Resources (Sheet 1 of 2)

NAME	DESCRIPTION
CaseMakingParams	Specific parameters to set up the machinery.
Component (CoverMaterial) ?	The cover material is either a preprinted or processed sheet of paper. Exactly one of Media (CoverMaterial) or Component (CoverMaterial) SHALL be specified.

Table 6.106: CaseMaking – Input Resources (Sheet 2 of 2)

NAME	DESCRIPTION
Media (CoverBoard) Modified in JDF 1.1A	The cardboard Media used for the cover board.
Media (CoverMaterial) ?	The CaseMaking process MAY also consume unprocessed Media as cover material. Exactly one of Media (CoverMaterial) or Component (CoverMaterial) SHALL be specified.
Media (SpineBoard) ?	The cardboard Media used for the spine board. If not specified, the Media (CoverBoard) SHALL be used for the spine board.

Table 6.107: CaseMaking – Output Resources

NAME	DESCRIPTION
Component	One Component is produced: the book case. Component /@ProductType SHALL be "BookCase".

6.5.7 CasingIn

New in JDF 1.1

The hardcover book case and the book block are joined in the **CasingIn** process.

Table 6.108: CasingIn – Input Resources

NAME	DESCRIPTION
CasingInParams	Specific parameters to set up the machinery.
Component (BookBlock)	The prepared book block.
Component (BookCase)	The hardcover book case.

Table 6.109: CasingIn – Output Resources

NAME	DESCRIPTION
Component	One Component is produced: the completed hardcover book.

6.5.8 ChannelBinding

Various sizes of metal clamps can be used in **ChannelBinding**. The process can be executed in two ways. In the first, a pile of single sheets – often with front and back covers – is inserted into a U-shaped clamp and crimped in special machinery. In the second, a pre-assembled cover that includes the open U-shaped clamp is used instead of the U-shaped clamp alone. The thickness of the pile of sheets determines in both cases the width of the U-shaped clamp to be used for forming the fixed document, which is not meant to be reopened later.

Table 6.110: ChannelBinding – Input Resources

NAME	DESCRIPTION
ChannelBindingParams	Specific parameters to set up the machinery.
Component	The operation requires one component: the block of sheets to be bound. If Component (Cover) is NOT provided and there is a cover, this Component SHALL be partitioned, and the first partition of this Component SHALL specify the cover Modification note: Starting with JDF 1.4, the input ComponentLink NEED NOT have @ProcessUsage= "BookBlock".
Component (Cover) ?	The empty cover with the U-shaped clamp that might, for example, have been printed before it is used during the ChannelBinding process.

Table 6.111: ChannelBinding – Output Resources

NAME	DESCRIPTION
Component	One Component is produced: the channel-bound component forming an item such as a brochure.

6.5.9 CoilBinding

Another name for **CoilBinding** is *spiral binding*. Metal wire, wire with plastic or pure plastic is used to fasten pre-punched sheets of paper, cardboard or other materials. Automated machinery first forms a spiral of proper diameter and length. The ends of the spiral are then “tucked-in”. Finally, the content is permanently fixed. Note that every time a coil-bound book is opened, a vertical shift occurs as a result of the coil action. This is a characteristic of the process.

Table 6.112: CoilBinding – Input Resources

NAME	DESCRIPTION
CoilBindingParams	Specific parameters to set up the machinery.
Component	The operation requires one component: the pile of pre-punched sheets often including a top and button cover.

Table 6.113: CoilBinding – Output Resources

NAME	DESCRIPTION
Component	One Component is produced: the coil-bound component forming an item such as a calendar.

6.5.10 Collecting

This process collects folded sheets or partial products, some of which might have been cut. The first **Component** to enter the workflow lies at the bottom of the pile collected on a saddle, and the sequence of the input components that follows depends upon the produced component. The figure to the right shows a typical collected pile.

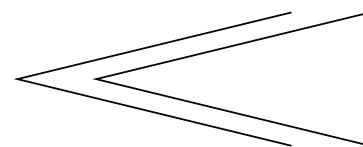

The operation coordinate system is defined as follows: The y-axis is aligned with the binding edge. It increases from the registered edge to the edge opposite the registered edge. The x-axis is aligned with the registered edge. It increases from the binding edge to the edge opposite to the binding edge (i.e., the product front edge).

Table 6.114: Collecting – Input Resources

NAME	DESCRIPTION
Assembly ? New in JDF 1.3	Assembly explicitly describes the sequence of the Component resources to be collected. If Assembly is not specified, the sequence SHALL be defined by the sequence of the Component . Caution: Assembly has the first on the outside, whereas the Component resources are listed from inside to outside.
CollectingParams ?	Specific parameters to set up the machinery.
Component +	Variable amount of sheets to be collected.
DBRules * Deprecated in JDF 1.5	Database input that describes which sheets are to be collected for a particular instance of a component. In this version the schema is only human readable text. One rule is applied for each individual component.
DBSelection ? Deprecated in JDF 1.5	Database input that describes which sheets are to be collected for a particular instance component.
IdentificationField ? Deprecated in JDF 1.2	Information about identification marks on the component. In JDF 1.2 and beyond, this information is defined in the Component itself.

Table 6.115: Collecting – Output Resources

NAME	DESCRIPTION
Component	A block of collected sheets is produced. This Component can be joined in further post-press processes.

6.5.11 CoverApplication

New in JDF 1.1

CoverApplication describes the process of applying a softcover to a book block.

Table 6.116: CoverApplication – Input Resources

NAME	DESCRIPTION
Component	The book block on which the cover is applied. If Component (Cover) is NOT provided, this Component SHALL be partitioned, and the first partition of this Component SHALL specify the cover.
Component (Cover) ? Modified in JDF 1.4	The softcover that is applied. Modification note: Starting with JDF 1.4, this Component is optional because of the new rule about partitioning the main Component specified above.
CoverApplicationParams	Specific parameters to set up the machinery.

Table 6.117: CoverApplication – Output Resources

NAME	DESCRIPTION
Component	The book block with the applied softcover.

6.5.12 Creasing

New in JDF 1.1

Sheets are creased or grooved to enable folding or to create even, finished page delimiters.

Table 6.118: Creasing – Input Resources

NAME	DESCRIPTION
Component Modified in JDF 1.2	This process consumes one Component . Note: Prior to JDF 1.2 this Component was OPTIONAL, which was clearly a typing mistake in the specification.
CreasingParams	Details of the Creasing process.

Table 6.119: Creasing – Output Resources

NAME	DESCRIPTION
Component	One creased Component is produced.

6.5.13 Cutting

Sheets are cut using a guillotine **Cutting** machine. Before **Cutting**, the sheets might be jogged and buffered. **CutBlock** resources and/or **CutMark** resources can be used for positioning the knife. After the **Cutting** process is performed, the blocks are often again buffered on a pallet.

Since **Cutting** is described here in the most machine independent manner, the specified **CutBlock** elements do not directly imply a particular cutting sequence. Instead, a specialized agent SHALL determine the sequence.

Media might also be cut in a pre-cutting step. In this case, **Cutting** MAY deliver **Media** as the output resource.

Cutting MAY also be used to describe cutting of a web into multiple ribbons on a web press. This process is commonly referred to as “Slitting”.

Table 6.120: Cutting – Input Resources

NAME	DESCRIPTION
Component ?	This process consumes one Component : the printed sheets. Exactly one of Component or Media SHALL be specified as input.
CutBlock * Deprecated in JDF 1.1	One or more CutBlock resources can be used to define the Cutting sequence. Either CutBlock or CuttingParams/Cut SHALL be specified, but not both.
CutMark * Deprecated in JDF 1.1	CutMark resources can be used to adapt the theoretical cut positions to the real positions of the corresponding blocks on the Component to be cut.
CuttingParams New in JDF 1.1	Details of the Cutting process.
Media ?	Cutting can be applied to Media in order to adjust size or shape. Exactly one of Component or Media SHALL be specified as input.

Table 6.121: Cutting – Output Resources

NAME	DESCRIPTION
Component * Modified in JDF 1.3	One or several blocks of cut Component resources are produced. When an input Component is cut, the output SHALL be a set of Component resources. Either Component or Media SHALL be specified as output, but not both.
Media * Modified in JDF 1.3	When Media are cut, the output SHOULD also be a set of Media . Either Component or Media SHALL be specified as output, but not both.

6.5.14 DieMaking

New in JDF 1.4

This process describes the production of tools for a die cutter (e.g., in a die maker shop).

Table 6.122: DieMaking – Input Resources

NAME	DESCRIPTION
DieLayout	A resource describing the die cutter tool set.

Table 6.123: DieMaking – Output Resources

NAME	DESCRIPTION
Tool +	The set of tools for the die cutter.

6.5.15 Dividing

Deprecated in JDF 1.1

Dividing has been replaced by **Cutting**.

6.5.16 Embossing

New in JDF 1.1

The **Embossing** process is performed after printing to stamp a raised or depressed image (artwork or typography) into the surface of paper using engraved metal embossing dies, extreme pressure and heat. Embossing styles include blind, deboss and foil-embossed.

Table 6.124: Embossing – Input Resources

NAME	DESCRIPTION
Component	This process consumes one Component that is embossed by the process.
EmbossingParams	Parameters to set up the machinery.
Media * Modified in JDF 1.4	Media SHOULD be provided if an EmbossingParams/Emboss/@EmbossingType="FoilEmbossing" or "FoilStamping" . Modification note: Starting with JDF 1.4 , Media can occur more than once.
Tool * Modified in JDF 1.4	The embossing stamps or calenders. Modification note: Starting with JDF 1.4 , Tool can occur more than once.

Table 6.125: Embossing – Output Resources

NAME	DESCRIPTION
Component	One Component is created.

6.5.17 EndSheetGluing

EndSheetGluing finalizes the book block in preparation for case binding by attaching end sheets to the book block. Back end sheets and front end sheets are in most cases sheets folded once before **EndSheetGluing** takes place. The end sheets serve as connections between the book block and the cover boards.

Table 6.126: EndSheetGluing – Input Resources

NAME	DESCRIPTION
Component Modified in JDF 1.5	A back end sheet and a front end sheet are glued onto the book block. Modification note: Starting with JDF 1.4 , the input ComponentLink NEED NOT have @ProcessUsage= "BookBlock" .
Component (BackEndSheet) ? Modified in JDF 1.5	A back end sheet that SHALL be mounted on the book block. At least one of Component , Component (BackEndSheet) or Component (FrontEndSheet) SHALL be present. Modification note: Starting with JDF 1.5 , this element is optional.
Component (FrontEndSheet) ? Modified in JDF 1.5	A front end sheet that SHALL be mounted on the book block. At least one of Component , Component (BackEndSheet) or Component (FrontEndSheet) SHALL be present. Modification note: Starting with JDF 1.5 , this element is optional.
EndSheetGluingParams	Specific parameters to set up the machinery.

Table 6.127: EndSheetGluing – Output Resources

NAME	DESCRIPTION
Component	A book block is produced that includes the end sheets.

6.5.18 Feeding

New in JDF 1.2

The **Feeding** process separates sheets or signatures from a stack, roll or stream and feeds single **Components** to processes such as **Folding**, **Gathering**, **Collecting**, **ConventionalPrinting**, etc. In general, the **Feeding** process will be part of a combined process with processes that consume the feed of **Components** or **Media**.

When used in a combined process with feed consuming process (e.g., **Gathering**), the **Feeding** process allows an arbitrary complex selection of input **Component** elements in any number, and in any order, as long as elements are consumed consecutively (i.e., no random access within a single input component).

When specified for a web press or web finishing device, **Feeding** describes the process of unwinding **Media** or **Components** from a roll.

Figure 6-5: Combined process with Feeding process

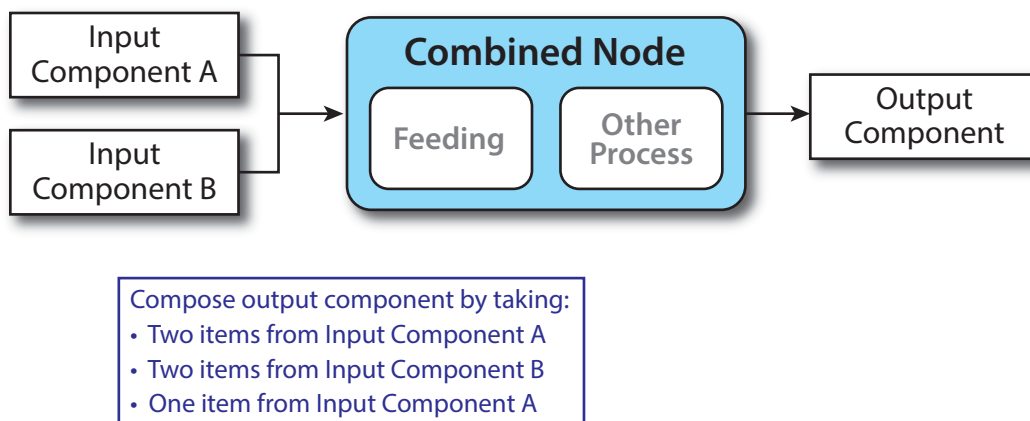

In our example above, one input component (Component A) is a bundle component (`@BundleType = "Stack"`) consisting of a collated set of three sheets, the other one (Component B) is a collated set consisting of two sheets per set. Both sets are oriented face-up, see ▶ Figure 6-6: Input components. ▶ Figure 6-7: Output component shows the output for the case of **Gathering**.

Figure 6-6: Input components

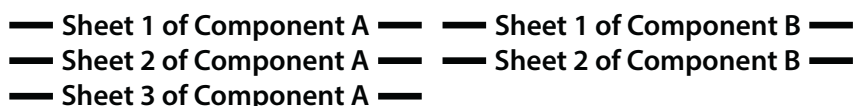
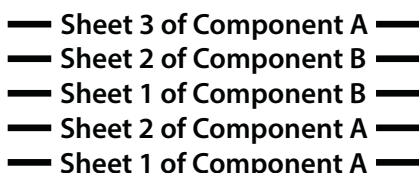

Figure 6-7: Output component



Note that, by default, none of the sheets is flipped, so surfaces of sheet 1 of **Component** A do not show in a different direction. To flip sheets, `FeedingParams/CollatingItem/@Orientation` MAY be specified.

Table 6.128: Feeding – Input Resources

NAME	DESCRIPTION
Component *	Sheets or signatures to be fed to the machinery. The <code>@ProcessUsage</code> of the Component MAY be specified as any valid <code>@ProcessUsage</code> of the feed consuming process.
FeedingParams	Specific parameters to set up the Feeding process.
Media *	Media to be fed to the feeder machinery.

Table 6.129: Feeding – Output Resources

NAME	DESCRIPTION
Component *	Component (s) fed to the consuming process.
Media *	Media fed to the consuming process.

6.5.19 Folding

Buckle folders or knife folders are used for **Folding** sheets. One or more sheets can be folded at the same time. Web presses often provide in-line **Folding** equipment. Longitudinal **Folding** is often performed using a former, a plow folder or a belt. Jaw folding, chopper folding or drum folding equipment is used for folding the sheets that have been divided.

The **JDF Folding** process covers both operations done in stand-alone **Folding** machinery—typically found when processing printed materials from sheet-fed presses—and in-line equipment of web presses. Creasing and/or slot perforating are sometimes necessary parts of the **Folding** operation that guarantee exact process execution. They depend on the folder used, the **Media** and the folding layout. These operations are specified in the **Creasing** and **Perforating** processes respectively.

Table 6.130: Folding – Input Resources

NAME	DESCRIPTION
Component	Component resources, including a printed sheet or a pile of sheets, are used in the Folding process.
FoldingParams	Specific parameters to set up the machinery.

Table 6.131: Folding – Output Resources

NAME	DESCRIPTION
Component Modified in JDF 1.1	The process produces a Component , which in most cases is a folded sheet.

6.5.20 Gathering

In the **Gathering** process, ribbons, sheets or other **Component** resources are accumulated on a pile that will eventually be stitched or glued in some way to create an individual **Component**. The input **Component** resources MAY be output resources of a Web-Printing machine used in **Collecting** or of any machine that executes a **ConventionalPrinting** or **DigitalPrinting** process. In sheet applications, a moving gathering channel is used to transport the pile. But no matter what the inception of the **Gathering** process, the sequence of the input components dictates the produced component. ▶ Figure 6-8: Gathering shows typical gathered piles.

Figure 6-8: Gathering



Table 6.132: Gathering – Input Resources (Sheet 1 of 2)

NAME	DESCRIPTION
Assembly ? New in JDF 1.3	Explicitly describes the sequence of the Component resources to be gathered. If Assembly is not specified, the sequence is defined by the sequence of the Component . Caution: Assembly has the first on the top, whereas the Component resources are listed from bottom to top.

Table 6.132: Gathering – Input Resources (Sheet 2 of 2)

NAME	DESCRIPTION
Component +	Variable amount of components including single sheets or folded sheets are used in the Gathering process. The first Component in the list lies at the bottom of the gathered pile.
DBRules * Deprecated in JDF 1.5	Database input that describes which sheets are to be gathered for a particular instance component. The schema are only in the form of human-readable text. One rule is applied for each individual component.
DBSelection ? Deprecated in JDF 1.5	Database input that describes which Sheets are to be gathered for a particular instance component.
GatheringParams	Specific parameters to set up the machinery.
IdentificationField ? Deprecated in JDF 1.2	Information about identification marks on the component. In JDF 1.2 and beyond, this information is defined in the Component itself.

Table 6.133: Gathering – Output Resources

NAME	DESCRIPTION
Component	Components gathered together (e.g., a pile of folded sheets).

6.5.21 Gluing

New in JDF 1.1

Gluing describes arbitrary methods of applying glue to a **Component**.

Table 6.134: Gluing – Input Resources

NAME	DESCRIPTION
Component	This process consumes one Component : the printed sheets.
GluingParams	Details of the Gluing process.

Table 6.135: Gluing – Output Resources

NAME	DESCRIPTION
Component	One Component is produced, the input Component with glue applied to it.

6.5.22 HeadBandApplication

New in JDF 1.1

Head bands are applied to the hardcover book block.

Table 6.136: HeadBandApplication – Input Resources

NAME	DESCRIPTION
Component	The prepared book block.
HeadBandApplicationParams	Specific parameters to set up the machinery.

Table 6.137: HeadBandApplication – Output Resources

NAME	DESCRIPTION
Component	One Component is produced: the hardcover block with head bands.

6.5.23 HoleMaking

A variety of machines (e.g., those responsible for stamping and drilling) can perform the **HoleMaking** process. This post-press process is needed for different binding techniques (e.g., spiral binding). One or several holes with different shapes can be made that are later on used for binding the book block together.

HoleMaking MAY be used to describe line hole punching that generates a series of holes with identical distance (pitch) running parallel to the edge of a web, which is mainly used to transport paper through continuous-feed printers and finishing devices (form processing). The final product is typically a web with two lines of holes, one at each edge of the web. The distance between holes within each line of holes is identical (constant pitch). In case of line hole punching, **HoleMakingParams/HoleLine/Hole/@Center** applies to the initial hole and **HoleMakingParams/HoleLine/Hole/@Extent** applies to each hole individually.

Sometimes line hole punching is performed for multiple webs before dividing the web after the **HoleMaking** process. The following figure shows the parameters for both cases.

Figure 6-9: Hole parameters

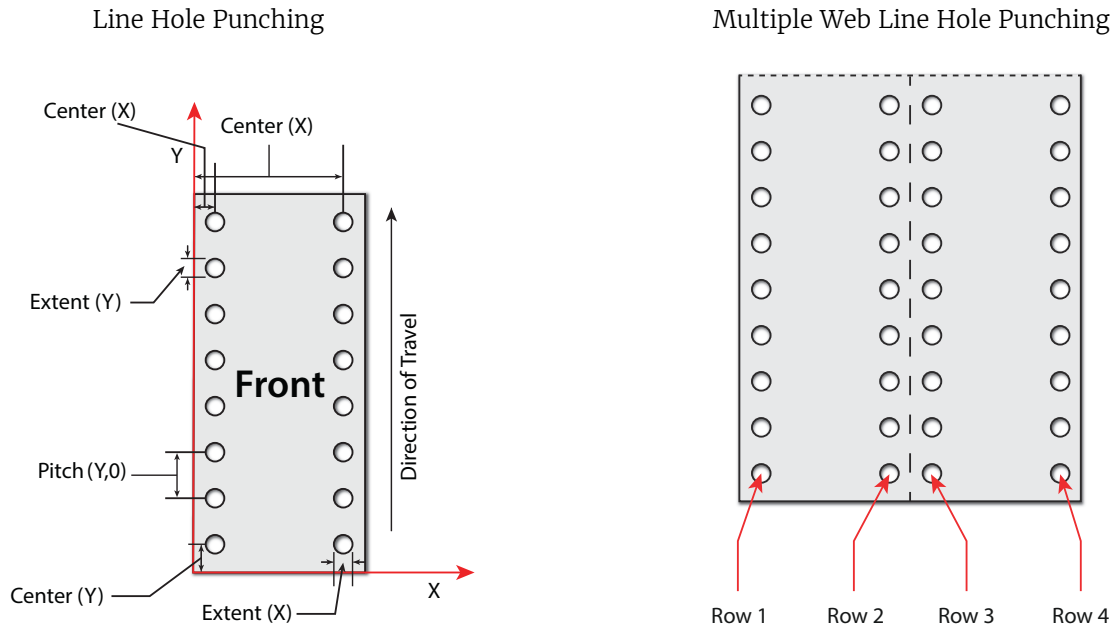

Table 6.138: HoleMaking – Input Resources

NAME	DESCRIPTION
Component	One Component (e.g., a printed sheet or a pile of sheets) is modified in the HoleMaking process.
HoleMakingParams	Specific parameters, including hole diameter and positions, used to set up the machinery.

Table 6.139: HoleMaking – Output Resources

NAME	DESCRIPTION
Component	A Component with holes (e.g., a book block or a single sheet) is produced for further postpress processes.

6.5.24 Inserting

This process can be performed at several stages in postpress. The process can be used to describe the labeling of products, labeling of packages or the gluing-in of a **Component** (e.g., a card, sheet or CD-ROM). Two **Component** resources are required for the **Inserting** process: the “mother” **Component** and the “child” **Component**. **Inserting** can be a selective process by means of inserting different “child” **Component** resources. Information regarding the placement is needed to perform the process. Inserting multiple child components is specified as a combined process with multiple individual **Inserting** steps.

Figure 6-10: Parameters and coordinate system used for Inserting

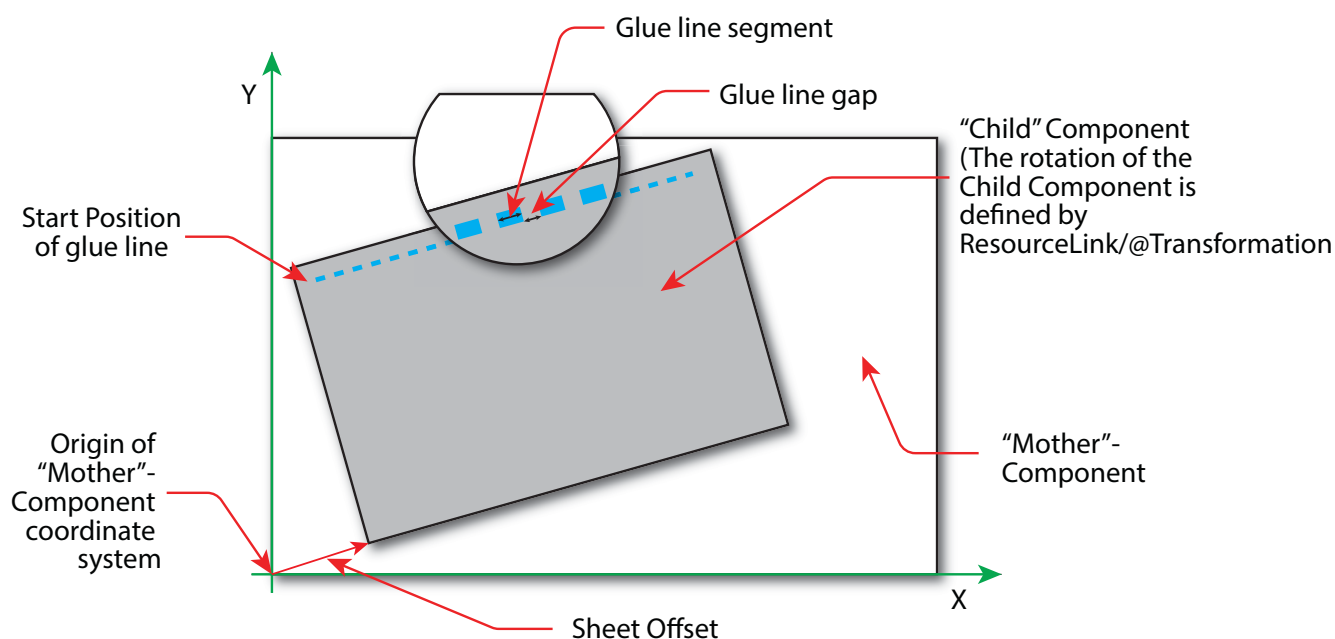

The process coordinate system is defined as follows: The Y-axis is aligned with the binding edge and increases from the registered edge to the edge opposite the registered edge. The X-axis, meanwhile, is aligned with the registered edge. It increases from the binding edge to the edge opposite the binding edge, which is the product front edge.

Table 6.140: Inserting – Input Resources

NAME	DESCRIPTION
Component Modified in JDF 1.4	Designates where to insert the child Component . Modification note: Starting with JDF 1.4 , the input ComponentLink NEED NOT have <code>@ProcessUsage= "Mother"</code> .
Component (Child)	The Component to be inserted in the mother Component .
DBRules ? Deprecated in JDF 1.5	Database input that describes whether the child is to be inserted for a particular instance Component . In this version the schema is only human readable text.
DBSelection ? Deprecated in JDF 1.5	Database input that describes whether the child is to be inserted for a particular instance Component .
IdentificationField ? Deprecated in JDF 1.2	Information about identification marks on the Component . In JDF 1.2 and beyond, this information is defined in the Component itself.
InsertingParams	Specific parameters (e.g., placement) to set up the machinery.

Table 6.141: Inserting – Output Resources

NAME	DESCRIPTION
Component	A mother Component is produced containing the inserted child Component .

6.5.25 Jacketing

New in JDF 1.1

Jacketing is the process where the book is wrapped by a jacket that needs to be folded twice. As long as the book is specified and the jacket dimensions are known, there are just a few important details. If the jacketing device also creases the jacket, this can be described with a combined process of **Jacketing** and **Creasing**.

Table 6.142: Jacketing – Input Resources

NAME	DESCRIPTION
Component (Book)	The book that the jacket is wrapped around.
Component (Jacket)	The description of the jacket.
JacketingParams	Specific parameters to set up the machinery.

Table 6.143: Jacketing – Output Resources

NAME	DESCRIPTION
Component	The jacketed book.

6.5.26 Labeling

New in JDF 1.1

A label can be attached to a bundle. The label can contain information on the addressee, the product, the product quantities, etc., which can be different for each bundle.

Table 6.144: Labeling – Input Resources

NAME	DESCRIPTION
Component	The Labeling process labels one Component with a set of labels.
Component (Label) ?	The label to be attached to the Component .
LabelingParams	Specific parameters to set up the machinery.

Table 6.145: Labeling – Output Resources

NAME	DESCRIPTION
Component	One Component is produced: the labeled Component .

6.5.27 Laminating

In the **Laminating** process, a plastic film is bonded to one or both sides of a **Component** resource’s media, and adhered under pressure with either a thermal setting or pressure sensitive adhesive.

Table 6.146: Laminating – Input Resources

NAME	DESCRIPTION
Component	A Component is REQUIRED for Laminating .
LaminatingParams	Specific parameters to set up the machinery.
Media ?	The laminating foil material.

Table 6.147: Laminating – Output Resources

NAME	DESCRIPTION
Component	One Component is produced: the laminated component.

6.5.28 LongitudinalRibbonOperations

Deprecated in JDF 1.1

In version 1.1 of **JDF** and beyond, in-line finishing is described using the “standard” finishing processes (e.g., **Creasing**, **Cutting**, **Folding**) or in a combined process node with **ConventionalPrinting**.

6.5.29 Numbering

Deprecated in JDF 1.5

Starting with **JDF** 1.5, use **LayoutElementProduction**. For details of the deprecated **Numbering** process.

6.5.30 Palletizing

New in JDF 1.1

Bundles, stacks, piles or boxes can be loaded onto a pallet.

Table 6.148: Palletizing – Input Resources

NAME	DESCRIPTION
Component +Modified in JDF 1.4	The Palletizing process describes placing the bundle that is represented by the Component onto a pallet. If more than one Component is specified, a PalletizingParams/Bundle resource SHALL also be specified. Modification note: Starting with JDF 1.4, Component can occur more than once.
Pallet	The pallet.
PalletizingParams	Specific parameters to set up the machinery.

Table 6.149: Palletizing – Output Resources

NAME	DESCRIPTION
Component	One Component is produced. It represents the loaded pallet. If more than one input Component is supplied, a Component/Bundle resource SHALL also be supplied in the output Component

6.5.31 Perforating

New in JDF 1.1

Perforating describes any process where a **Component** is perforated. **Perforating** includes production perforation applied as a preparation for **Folding**.

Table 6.150: Perforating – Input Resources

NAME	DESCRIPTION
Component	This process consumes one Component : the printed sheets.
PerforatingParams	Details of the Perforating process.

Table 6.151: Perforating – Output Resources

NAME	DESCRIPTION
Component	One Component is produced.

6.5.32 PlasticCombBinding

In the **PlasticCombBinding** process, a plastic insert wraps through pre-punched holes in the substrate. Most often, these holes are rectangular and elongated. After the plastic comb is opened with a special tool, the pre-punched block of sheets – often together with a top and button cover – is inserted onto the “teeth” of the plastic comb. When released from the machine, the teeth return to their original cylindrical positions with the points tucked into the backside of the spine area. Special machinery can be used to reopen the plastic comb binding.

Table 6.152: PlasticCombBinding – Input Resources

NAME	DESCRIPTION
Component	The operation requires one component: the pile of sheets often including a top and button cover.
PlasticCombBindingParams	Specific parameters to set up the machinery.

Table 6.153: PlasticCombBinding – Output Resources

NAME	DESCRIPTION
Component	One Component is produced: the plastic-comb-bound component forming an item such as a calendar.

6.5.33 PrintRolling

New in JDF 1.2

The single products like sheets, signatures or partial products are rolled onto a roll stand. The roll is the output component of the process and is used to store the products. The single components of a roll are used as input component of a consuming process (e.g., **Collecting**, **Gathering** or **Inserting**). See ▶ Figure 6-11: Print roll

Figure 6-11: Print roll



Table 6.154: PrintRolling – input resources

NAME	DESCRIPTION
Component ?	Component to be rolled.
PrintRollingParams ?	Print rolling parameters.
RollStand ?	Roll stand to store the component(s) as rolls.

Table 6.155: PrintRolling – output resources

NAME	DESCRIPTION
Component ?	The print roll.

6.5.34 RingBinding

In this process, pre-punched sheets are placed in a ring binder. Ring binders have different numbers of rings that are fixed to a metal backbone. In most cases, two, three or four metal rings hold the sheets together as long as the binding is closed. Depending on the amount of sheets to be bound together, ring binders of different thickness SHALL be used.

Table 6.156: RingBinding – Input Resources

NAME	DESCRIPTION
Component Modified in JDF 1.4	The operation requires one component: the pile of pre-punched sheets to be inserted into the ring binder. Modification note: Starting with JDF 1.4 , the input ComponentLink NEED NOT have @ProcessUsage= "BookBlock" .
Component (RingBinder) ?	The empty ring binder that might have been printed, for example, before it is used during the RingBinding process.
RingBindingParams	Specific parameters to set up the process/machinery.

Table 6.157: RingBinding – Output Resources

NAME	DESCRIPTION
Component	One Component is produced: the ring-bound component forming an item such as a calendar.

6.5.35 SaddleStitching

Deprecated in JDF 1.1

SaddleStitching has been replaced by **Stitching** in **JDF 1.1**.

6.5.36 ShapeCutting

New in JDF 1.1

The **ShapeCutting** process can be performed using tools such as hollow form punching, perforating or die-cutting equipment.

Table 6.158: ShapeCutting – Input Resources

NAME	DESCRIPTION
Component	This process consumes one Component that are the sheets to be cut.
ShapeCuttingParams ? Modified in JDF 1.3	Details of the ShapeCutting process.
Tool * Modified in JDF 1.3	The set of tools (die, counter, blankers, strippers, etc.).

Table 6.159: ShapeCutting – Output Resources

NAME	DESCRIPTION
Component + Modified in JDF 1.3	One or more Components are produced by the ShapeCutting process.

6.5.37 Shrinking

New in JDF 1.1

The **Shrinking** process shrinks the shrink-wrap that is wrapped around a bundle. Shrink-wrap foil SHALL be treated in order to shrink.

Note: **Shrinking** does NOT include the wrapping of the **Component** with foil. The actual wrapping is described by the **Wrapping** process. See ▶ Section 6.5.52 Wrapping.

Table 6.160: Shrinking – Input Resources

NAME	DESCRIPTION
Component	The Bundle including the shrink-wrap media is represented by this Component .
ShrinkingParams	Specific parameters to set up the machinery.

Table 6.161: Shrinking – Output Resources

NAME	DESCRIPTION
Component	One Component is produced: the bundle including the shrunk shrink-wrap media.

6.5.38 SideSewing

Deprecated in JDF 1.1

SideSewing has been replaced by **ThreadSewing**.

6.5.39 SpinePreparation

New in JDF 1.1

The **SpinePreparation** process describes the preparation of the spine of book blocks for hard and softcover book production (e.g., milling and notching).

Table 6.162: SpinePreparation – Input Resources

NAME	DESCRIPTION
Component	The raw book block.
SpinePreparationParams	Specific parameters to set up the machinery.

Table 6.163: SpinePreparation – Output Resources

NAME	DESCRIPTION
Component	The book block with a processed spine.

6.5.40 SpineTaping

New in JDF 1.1

SpineTaping describes the process of applying a tape strip to the spine of a book block. It also describes the process of applying kraft paper to a hardcover book block.

Table 6.164: SpineTaping – Input Resources

NAME	DESCRIPTION
Component	The book block that the spine is taped to.
SpineTapingParams	Specific parameters to set up the machinery.

Table 6.165: SpineTaping – Output Resources

NAME	DESCRIPTION
Component	The book block with the spine.

6.5.41 Stacking

New in JDF 1.1

The **Stacking** process collects **PhysicalResources** and produces a pile, stack or bundle for delivery. In a standard production each bundle consists of the same amount of identical products, possibly followed by one or more odd-count bundles. In a production with variable data (e.g., newspaper dispatch, demographic production or individual addressed products), each bundle has a variable amount of products, and, in the worst case, each product can be different from the others. The input components are single products; the output components are stacks of this product.

A stack of components might be uneven and unstable, due to variations in thickness across each component. The thickness variations might be caused by folding, binding or inserted components. A stack might be split into layers, with successive layers rotated by 180° to compensate for the unevenness (▶ Figure 6-12: Stacking layers).

Figure 6-12: Stacking layers

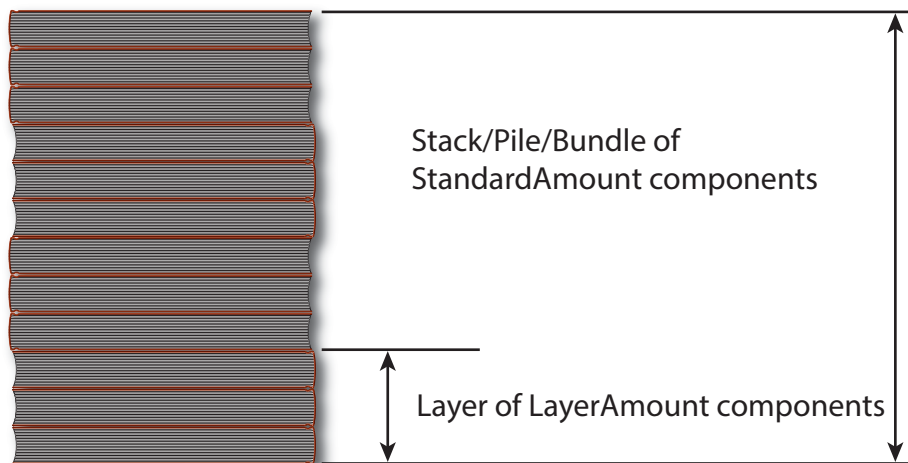



If the thickest part is on an edge (e.g., a book binding), the components might be offset to separate the thick parts. Layer compensation and offsetting can be combined as in the following examples of pile patterns.

Table 6.166: Parameters in Stacking^a

PILE PATTERN	STANDARD AMOUNT	LAYER AMOUNT <i>(Default = StandardAmount)</i>	COMPENSATE <i>(Default = true)</i>	DISJOINTING OFFSET
	6	6	true	0 0
	6	1	true	0 0
	6	1	false	x 0
	6	1	true	x 0

Table 6.166: Parameters in Stacking^a

PILE PATTERN	STANDARD AMOUNT	LAYER AMOUNT (Default = StandardAmount)	COMPENSATE (Default = true)	DISJOINTING OFFSET
	6	3	true	0 0
	6	3	false	x 0
	6	3	true	x 0

a. Column headings 'STANDARD AMOUNT', 'LAYER AMOUNT', 'COMPENSATE' and 'DISJOINTING OFFSET' refer to the values in *StackingParams/@StandardAmount*, *StackingParams/@LayerAmount*, *StackingParams/@Compensate* and *StackingParams/Disjointing/@Offset* respectively.

If the number of components is not evenly divisible by *StackingParams/@StandardAmount* or the number of components in a bundle is not evenly divisible by *StackingParams/@LayerAmount*, there will be a remainder, yielding one or more odd-count stacks or layers. By default, the odd-count stack or layer size can contain as few as one component. This might exceed equipment cycle times, and flimsy components (newspapers) might cause problems with downstream equipment, such as strappers. *StackingParams/@MinAmount* and *StackingParams/@MaxAmount* control the minimum and maximum size of odd-count stacks and layers. The following figures show the odd count handling for bundles and layers.

Figure 6-13: Odd count handling for a bundle

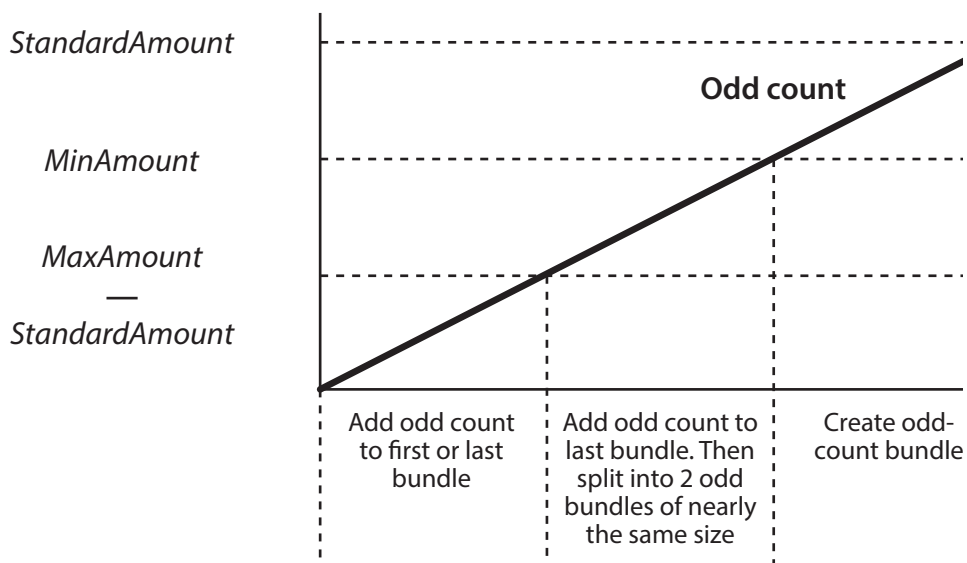

Figure 6-14: Odd count handling for a layer

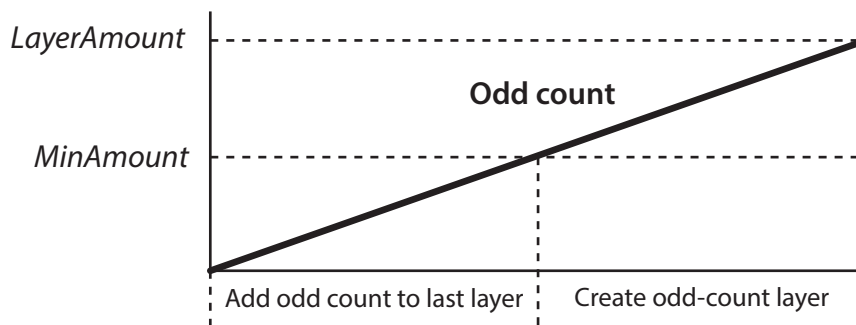

Table 6.167: Stacking – Input Resources

NAME	DESCRIPTION
Component	The Stacking process consumes one Component and stacks it onto a stack.
StackingParams	Specific parameters to set up the machinery.

Table 6.168: Stacking – Output Resources

NAME	DESCRIPTION
Component	One Component is produced: the stack of input components.

6.5.42 StaticBlocking

New in JDF 1.4

The **StaticBlocking** process puts an electrical charge on a stack in order to hold it together for shipping.

Table 6.169: StaticBlocking – Input Resources

NAME	DESCRIPTION
Component	The StaticBlocking process puts an electrical charge on the specified Component .
StaticBlockingParams	Specific parameters for the electrical charging.

Table 6.170: StaticBlocking – Output Resources

NAME	DESCRIPTION
Component	The resulting electrically charged Component .

6.5.43 Stitching

Gathered or collected sheets or signatures are stitched together with a cover. This process can be used to describe corner stitching, side stitching or saddle stitching.

Table 6.171: Stitching – Input Resources

NAME	DESCRIPTION
Component	A Component is REQUIRED that represents the pile of gathered or collected sheets, including the cover.
StitchingParams	Specific parameters to set up the machinery.

Table 6.172: *Stitching – Output Resources*

NAME	DESCRIPTION
Component	One Component is produced: the gathered or collected sheets including the cover stitched together.

Example 6.10: **Stitching: Combined Process**

Components containing staples of different characteristics like shape, width, etc. are defined by a combined process.

```
<JDF ID="CombinedStitch" JobID="Stitching special" JobPartID="ID123"
  Status="Ready" Type="Combined" Types="Stitching Stitching"
  Version="1.6" xmlns="http://www.CIP4.org/JDFSchema_1_1">
  <ResourcePool>
    <StitchingParams Class="Parameter" ID="Stitch1" NumberOfStitches="2"
      StapleShape="Butted" Status="Available" StitchPositions="100 700"
      StitchWidth="28.3" WireBrand="Steel" WireGauge="2.3"/>
    <StitchingParams Class="Parameter" ID="Stitch2" NumberOfStitches="2"
      StapleShape="Eyelet" Status="Available" StitchPositions="300 500"
      StitchWidth="42.5" WireBrand="Steel" WireGauge="2.3"/>
    <Component Class="Quantity" ComponentType="Sheet" ID="Comp1" Status="Available"/>
    <Component Class="Quantity" ComponentType="Sheet" ID="Comp2" Status="Unavailable"/>
  </ResourcePool>
  <ResourceLinkPool>
    <StitchingParamsLink CombinedProcessIndex="0" Usage="Input" rRef="Stitch1"/>
    <StitchingParamsLink CombinedProcessIndex="1" Usage="Input" rRef="Stitch2"/>
    <ComponentLink Usage="Input" rRef="Comp1"/>
    <ComponentLink Usage="Output" rRef="Comp2"/>
  </ResourceLinkPool>
</JDF>
```

6.5.44 Strapping

New in JDF 1.1

A bundle MAY be strapped. There are different kinds of strapping (e.g., single (one strap around the bundle), double (two parallel straps) and cross (two crossed straps)).

Table 6.173: *Strapping – Input Resources*

NAME	DESCRIPTION
Component	The Strapping process puts straps around a bundle that is represented by a Component .
Strap ?	The straps used.
StrappingParams	Specific parameters to set up the machinery.

Table 6.174: *Strapping – Output Resources*

NAME	DESCRIPTION
Component	One Component is produced: the strapped Component .

6.5.45 StripBinding

New in JDF 1.1

Hard plastic strips are held together by plastic pins, which in turn are bound to the strips with heat. The sheets to be bound SHALL be pre-punched so that the top strip with multiple pins fits through the assembled material. It is then connected to the bottom strip with matching holes for the pins. The binding edge is often compressed in a special machine before the excess pin length is cut off. The backstrip is permanently fixed with plastic clamping bars and cannot be removed without a special tool.

Table 6.175: StripBinding – Input Resources

NAME	DESCRIPTION
Component	The operation requires one component: the block of sheets to be bound.
StripBindingParams	Specific parameters to set up the machinery.

Table 6.176: StripBinding – Output Resources

NAME	DESCRIPTION
Component	One Component is produced: the strip-bound component forming an item such as a book.

6.5.46 ThreadSealing

New in JDF 1.1

ThreadSealing involves sewing the spines of individual signatures of a book with pieces of meltable thread prior to **Gathering**. The thread is melted by applying heat during **SpinePreparation**. In practice, **ThreadSealing** will often be combined with **Folding** in a single process.

Table 6.177: ThreadSealing – Input Resources

NAME	DESCRIPTION
Component	This process consumes one Component that is the gathered individual folded signatures.
ThreadSealingParams	Details of the ThreadSealing process.

Table 6.178: ThreadSealing – Output Resources

NAME	DESCRIPTION
Component	One Component is produced, the individual folded and sewn signatures.

6.5.47 ThreadSewing

This process involves stitching signatures together with thread to create a book block.

Table 6.179: ThreadSewing – Input Resources

NAME	DESCRIPTION
Component	The operation requires one Component that is the gathered individual folded signatures.
ThreadSewingParams	Specific parameters to set up the machinery.

Table 6.180: ThreadSewing – Output Resources

NAME	DESCRIPTION
Component	One Component is produced: the thread-sewn components forming an item such as a raw book block.

6.5.48 Trimming

The **Trimming** process is performed to adjust a book block or sheet to its final size. In most cases, it follows a block joining process, and the process is often executed as an in-line operation of a production chain. For example, the binding station might deliver the book blocks to the trimmer. A combined process in the trimming machinery would then execute a cut at the front, head and tail in a cycle of two operations. Closed edges of folded signatures would then be opened while the book block is trimmed to its predetermined dimensions.

PROCESSES

The separation of N-up multiple products is specified with a **Cutting** process prior to a **Trimming** process.

The process coordinate system is defined as follows:

- The X-axis SHALL be aligned with the registered side. It increases from the binding side to the face side.
- The Y-axis SHALL be aligned with the binding side. It increases from the registered edge.

Figure 6-15: Parameters and coordinate system used for trimming

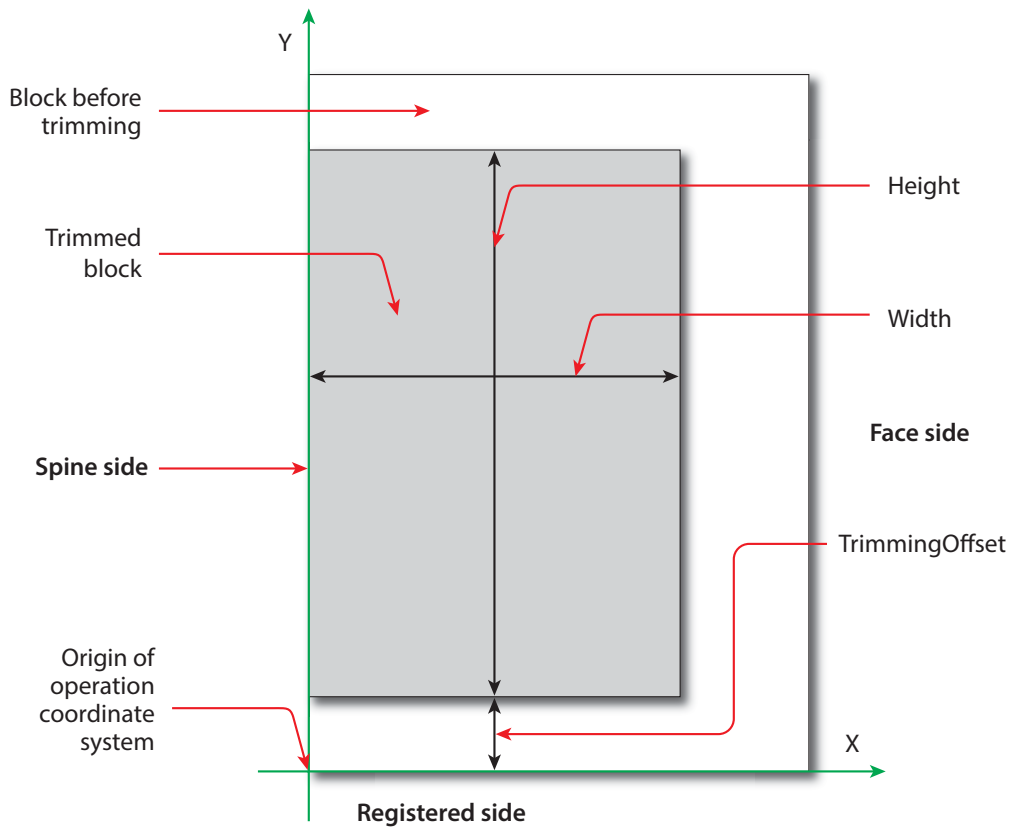

Table 6.181: Trimming – Input Resources

NAME	DESCRIPTION
Component Modified in JDF 1.2	The bound book block or sheet that will be trimmed.
TrimmingParams	Specific parameters (e.g., trim size) to set up the machinery.

Table 6.182: Trimming – Output Resources

NAME	DESCRIPTION
Component	One Component is produced: the trimmed component.

6.5.49 WebInlineFinishing

New in JDF 1.3

The **WebInlineFinishing** process combines all additional information about inline finishing functionality in connection with Web printing. In order to describe the **WebInlineFinishing** functionality fully, it is necessary to combine additional processes, such as **Stitching**, **Trimming**, **Gluing**, etc.

Table 6.183: WebInlineFinishing – Input Resources

NAME	DESCRIPTION
Assembly ?	In context of newspaper printing, Assembly describes how the newspaper job is sub-divided in physical sections and bound together.
Component	Printed webs or ribbons, which will be processed by the WebInlineFinishing process.
ProductionPath ?	ProductionPath describes the paper path that is used through the press and describes exactly one particular product which has to be produced.
StrippingParams ?	Defines how the surfaces of the bindery signatures of a single job or jobs are placed onto the web(s) or sheet(s). This information MAY be used for counting the amount of components produced.
WebInlineFinishingParams ?	Additional parameters for production are described by WebInlineFinishingParams .

Table 6.184: WebInlineFinishing – Output Resources

NAME	DESCRIPTION
Component	Describes the finished printed Component out of web inline finishing equipment. This could be printed and/or folded sheets or rolls. With one production run, it is possible to produce more than one product / order. Component MAY be partitioned by @WebProduct

6.5.50 Winding

New in JDF 1.5

The **Winding** process describes the winding of continuous media or processed components onto a core. The setup is defined in **WindingParams**. The final orientation of the labels on the output roll is specified in **Component**/@WindingResult.

Table 6.185: Winding – Input Resources

NAME	DESCRIPTION
Component	Ribbon or web to be wound. Exactly one of Media or Component SHALL be specified.
Media ?	Unprocessed Media MAY be wound. Exactly one of Media or Component SHALL be specified.
Media (Core) ?	Core that the input Component is wound around.
WindingParams ?	Setup parameters of the winding process.

Table 6.186: Winding – Output Resources

NAME	DESCRIPTION
Component	The roll including the core and the wound products. Component /@WindingResult SHALL be evaluated to determine the winding orientation.

6.5.51 WireCombBinding

In **WireCombBinding** metal wire, wire with plastic or pure plastic is used to fasten pre-punched sheets of paper, cardboard or other such materials. The wire – often formed as a double wire – is inserted into the holes, then curled to create a circular enclosure.

Table 6.187: WireCombBinding – Input Resources

NAME	DESCRIPTION
Component	The operation requires one component: the pile of preprinted sheets, often including a front and back cover.
WireCombBindingParams	Specific parameters to set up the machinery.

Table 6.188: WireCombBinding – Output Resources

NAME	DESCRIPTION
Component	One Component is produced: the wire-comb bound component forming an item such as a calendar.

6.5.52 Wrapping

New in JDF 1.1

Single products, bundles or pallets can be wrapped by film or paper.

Table 6.189: Wrapping – Input Resources

NAME	DESCRIPTION
Component	The Wrapping process wraps a bundle that is represented by a Component .
Component (Wrapper) ? New in JDF 1.6	If the wrapping material is preprinted, then Component (Wrapper) represents the wrapping material. Rubber bands and other non-printed material SHOULD be represented as MiscConsumable .
Media ? Deprecated in JDF 1.6	The wrapping material. Note: From version 1.6 use a Component(Wrapper) and/or a MiscConsumable .
MiscConsumable (Wrapper) ? New in JDF 1.6	Additional details of the wrapper material. Non-printed material SHOULD be represented as MiscConsumable . MiscConsumable(Wrapper) SHALL NOT be present if Component (Wrapper) is provided. MiscConsumable/@Type SHOULD be one of "PaperBand", "PaperWrap", "PlasticBand", "RubberBand" or "ShrinkWrap".
WrappingParams	Specific parameters to set up the machinery.

Table 6.190: Wrapping – Output Resources

NAME	DESCRIPTION
Component	One Component is produced: the wrapped Component .

6.6 Postpress Processes Structure

6.6.1 Block Production

This subcategory of the postpress processes merges together all the processes for making a book block. First, the block is compiled using the **Collecting** and **Gathering** processes. It is then combined using one or several of the block joining processes, including **CoverApplication**, **SpineTaping**, **Stitching** and **ThreadSewing**. The workflow using these processes eventually produces a **Component** that can be trimmed.

6.6.1.1 Block Compiling

The **Gathering** and **Collecting** processes are used to position unfolded sheets and/or folded sheets in a specific order. These operations set a fixed page sequence in preparation for three-side trimming and binding. Block compiling includes:

- **Collecting**
- **Gathering**
- **PrintRolling**

- **Feeding**
- **Winding**

6.6.1.2 Block Joining

The block joining processes can be grouped into two major subcategories: conventional binding methods, which includes the processes of **Stitching**, **CoverApplication**, **SpinePreparation**, **SpineTaping**, **ThreadSealing** and **ThreadSewing**; and single-leaf binding methods, which are listed in ▶ Section 6.6.1.3.1 Single-Leaf Binding Methods. Together, they form a subcategory of block-production processes. All of these processes, which are known as block joining processes, unite sheets and/or folded sheets lying loosely on top of each other.

There are numerous possible binding methods. The most prominent ones are modeled by the processes described in the following sections. Many of them can be part of a combined production chain being performed as in-line tasks. Block joining includes:

- **CoverApplication**
- **EndSheetGluing**
- **Gluing**
- **SpinePreparation**
- **SpineTaping**
- **Stitching**
- **ThreadSewing**

6.6.1.3 Binding Methods

6.6.1.3.1 Single-Leaf Binding Methods

Besides the conventional binding methods, there is a multifaceted group of binding methods for single-leaf bindings. This group can again be subdivided into two subtypes: loose-leaf binding and mechanical binding, each of which is described in the sections that follow.

6.6.1.3.2 Loose-Leaf Binding Method

These binding techniques allow contents to be changed, inserted or removed at will. There are two essential groups of loose-leaf binding systems: those that require the paper to be punched or drilled and those that do not. The **RingBinding** method, described in the next section, is the most prominent binding in the loose-leaf binding category. Loose-leaf binding methods include:

- **RingBinding**

6.6.1.3.3 Mechanical Binding Methods

Single leaves are fastened into what is essentially a permanent system that is not meant to be reopened. However, special machinery can be used to reopen some of the mechanical binding systems described below.

In mechanical binding, printing and folding can be done in a conventional manner. The gathered sheets, however, often require the back to be trimmed, as well as the other three sides. Mechanical bindings are often used for short-run jobs such as ones that have been printed digitally. The most prominent mechanical binding processes are described in the sections that follow. Mechanical binding methods include:

- **ChannelBinding**
- **CoilBinding**
- **PlasticCombBinding**
- **RingBinding**
- **StripBinding**
- **WireCombBinding**

6.6.2 HoleMaking

- **HoleMaking**

6.6.3 Laminating

- **Laminating**

6.6.4 Numbering

- **Numbering**

6.6.5 Packaging Processes

The individual processes defined in this section replace the deprecated **Packing** process. Packaging processes include:

- **BoxPacking**
- **Bundling**
- **Labeling**
- **Palletizing**

PROCESSES

- **Shrinking**
- **Stacking**
- **Strapping**
- **Wrapping**

6.6.6 Processes in Hardcover Book Production

The following processes refer to the production of hardcover books. Several processes are needed to produce a hardcover book. Some of them are essential and others are optional. The processes are:

CaseMaking: Production of hardcover book cases.

BlockPreparation: The optional hardcover design elements (e.g., rounding and backing, ribbon band, head band, side gluing and tightbacking) are described in this process. Application of kraft paper to the book block is described in the **SpineTaping** process.

CasingIn: In this process, the case and the prepared book block are brought together.

Jacketing: In the **Jacketing** process, the jacket is wrapped around the hardcover book.

Processes in hardcover book production include:

- **BlockPreparation**
- **CaseMaking**
- **CasingIn**
- **Collecting**
- **Gluing**
- **HeadBandApplication**
- **Jacketing**
- **SpinePreparation**
- **SpineTaping**
- **ThreadSealing**
- **ThreadSewing**

6.6.7 Sheet Processes

Many printing processes produce sheets that are processed further in finishing operations. The web processes presented in the preceding sections result in sheets that are treated in much the same way as sheets produced by Sheet-Fed printing presses. The following processes describe these sheet finishing operations. Sheet processes include:

- **Creasing**
- **Cutting**
- **Embossing**
- **Feeding**
- **Folding**
- **Gathering**
- **Gluing**
- **Palletizing**
- **Perforating**
- **PrintRolling**
- **ShapeCutting**
- **ThreadSealing**
- **Winding**

6.6.8 Tip-on/in

The processes **EndSheetGluing** and **Inserting** are part of the postpress operations. They can be grouped together as a tip-on/in process. Either part can be performed by hand, tip-on/in machine or by a press. Tip-on/in includes:

- **EndSheetGluing**
- **Inserting**

6.6.9 Trimming

- **Trimming.**

6.6.10 Web Processes

This sub-chapter of the postpress processes is dedicated to web and ribbon operations (i.e., operations that require a web or a ribbon to execute). In essence, a ribbon is a web that has been slit or cross-cut. More specifically, a web is a continuous strip of **Media** to be used for printing (e.g., paper or foil). This substrate is called “Web” while it is threaded through the printing machinery, but once it has run through the **Cutting** process and been slit, the web no longer exists. In its place are ribbons or sheets.

A ribbon, then, is the part of the web that enters the folder. If the web is never slit, however, the web and the ribbon are identical. Slitting and salvage-trim operations on a web can result in one or more ribbons. A ribbon can be further sub-

divided after it has been slit. After the **Cutting** process, sheets are treated further. The **Gathering** process and **Folding** process also handle web and ribbon applications.

7 Product Intent

As was described in ▶ Section 4.1.1 Product Intent Constructs, **Intent Resources** are designed to narrow down the available options when defining a **JDF** job. Many of the elements in **Intent Resources** are OPTIONAL. If an OPTIONAL element of an **Intent Resource** is omitted and no additional information is specified in the description, the value defaults to “don’t care”. If an entire **Intent Resource** that specifies a given product feature is omitted, then that feature is not requested. For instance, if a product intent description has no **ResourceLink** to **BindingIntent**, then no binding is requested. The characteristics of the product that are not specified through the use of **Intent Resources** will be selected by the system that processes the **Intent Resources**. The system that processes the product intent data in a **JDF** job ticket MAY insert the details of its selection into the **JDF** data for the job. See ▶ Section 1.5.2.1 Conformance Requirements for Support of Attributes and Attribute Values for more information on the handling and processing of systems-specified default values.

All **Intent Resources** share a set of subelements that allow a ‘Request for Quote’ to describe a range of acceptable values for various aspects of the product. These elements, taken together, allow an administrator to provide a specific value for the quote.

7.0.1 Product Intent Descriptions

Product intent is also described as a **JDF** node. The following table defines the list of **JDF Intent Resources** used to describe product intent.

Table 7.1: Product Intent – Input Resources (Sheet 1 of 2)

NAME	DESCRIPTION
ArtDeliveryIntent ?	This resource specifies the prepress art delivery intent for a JDF job.
BindingIntent ?	This resource specifies the binding intent for a JDF job.
ColorIntent ?	This resource specifies the type of ink to be used for a JDF job.
Component *	Components that are partial products of the product described by this node. If input Component resources are specified, at least one of BindingIntent or InsertingIntent is REQUIRED.
DeliveryIntent ?	Summarizes the options that describe pickup or delivery time and location of the PhysicalResources of a job.
EmbossingIntent ?	This resource specifies the embossing and/or foil stamping intent for a JDF job.
FoldingIntent ?	This resource specifies the fold intent for a JDF job using information that identifies the number of folds, the height and width of the folds, and the folding catalog number.
HoleMakingIntent ?	This resource specifies the hole making intent for a JDF job.
InsertingIntent ?	This resource specifies the placing or inserting of one component within another, using information that identifies page location, position and attachment method.
LaminatingIntent ?	This resource specifies the laminating intent for a JDF job using information that identifies whether or not the product is laminated.
LayoutIntent ?	This resource records the size of the finished pages for the product component.
MediaIntent ?	This resource describes the media to be used for the product component.
NumberingIntent ?	This resource describes the parameters of stamping or applying variable marks in order to produce unique components, for items such as lottery notes or currency.
PackingIntent ?	This resource specifies the packaging intent for a JDF job, using information that identifies the type of package, the wrapping used and the shape of the package.
ProductionIntent ?	This resource specifies the manufacturing intent and considerations for a JDF job using information that identifies the desired result or specified manufacturing path.

Table 7.1: Product Intent – Input Resources (Sheet 2 of 2)

NAME	DESCRIPTION
ProofingIntent ?	This resource specifies the prepress proofing intent for a JDF job, using information that identifies the type, quality, brand name and overlay of the proof.
PublishingIntent ?	This resource specifies publishing metadata that are of general interest for prepress, press and postpress. The data include details on the general structure of the product being published.
ScreeningIntent ?	This resource specifies the screening intent parameters desired for a JDF job.
ShapeCuttingIntent ?	This resource specifies form and line cutting for a JDF job.
SizeIntent ? Deprecated in JDF 1.2	This resource records the size of the finished pages for the product component. SizeIntent has been deprecated in JDF 1.1. All contents have been moved to LayoutIntent .
VariableIntent ? New in JDF 1.6	This resource specifies the variations for printed data with variable content.

Table 7.2: Product Intent – Output Resources

NAME	DESCRIPTION
Component +	Resource representation of the output this product intent node. Multiple Component resources SHALL be specified in a root node that contains a DeliveryIntent that references multiple Component resources as delivery end products.

7.1 Intent Properties Template

Each of the following sections begins with a brief narrative description of the resource. Following that is a list containing details about the properties of the resource, as shown below. The first item in the list provides the class of the resource, which, in this section is always "Intent". For more information on resource class, see ▶ Section 3.8.5 Resource Classes. A template of this list is shown below.

After the list describing the resource properties, each section contains tables that outline the structure of each resource and, when applicable, the abstract or subelement information that pertains to the resource structure. The first column contains the name of the attribute or element. A template of these tables is also provided below.

Note: For the resource properties template below, the *italicized* text describes the actual text that would be in its place in an actual resource definition.

Note: For the resource structure template table below: *Cardinality* in the Name column of the resource structure template table refers to a cardinality symbol, which is either empty or consists of a symbol, such as "?". Examples described by the Name column include: "[Ink](#) *" and "[FileSpec](#)("DeviceLinkProfile")?". For further details, see ▶ Section 1.3.5 Specification of Cardinality.

Intent Properties Template

- Resource Class:** Defines the resource class.
- Process Resource Pairing:** List of process resources with which an intent resource is generally identified. In practice, the process resources will contain the data with which the customer’s intent is fulfilled in production and distribution of the product. This is a list of the primary resources and not a complete list.
- Example Partition** List of recommended partition keys: For a complete list of partition keys, see the description of [@PartIDKeys](#) in ▶ Table 3.21 Partitionable Resource Element.
Note: Resources may be partitioned by keys that are not specified in this list.

Table 7.3: Template for Intent Resources (Sheet 1 of 2)

NAME	DATA TYPE	DESCRIPTION
Attribute-Name Cardinality	Attribute- data-type	Information about the attribute.
Element-Name Cardinality	element	Information about the element. Note: The "element" data type means that the specified element SHALL be an in-line subelement within the resource.

Table 7.3: Template for Intent Resources (Sheet 2 of 2)

NAME	DATA TYPE	DESCRIPTION
Element-Name Cardinality	refelement	Information about the element Note: The “refelement” data type means that the specified element is based on other atomic resources or resource elements. The specified element SHALL be either an in-line element or an instance of a resourceRef element (see ▶ Section 3.10.2 ResourceRef – Element for Inter-Resource Linking and reelement). In case of a ResourceRef element, a “Ref” SHALL be appended to the name specified in the table column entitled “Name”.

Intent Resource contain subelements that allow spans of values to be specified. These subelements also provide mechanisms to select a set of values from the provided range and map them to a set of quotes. These subelements are called span elements. The span element to use is determined by the data type of the values to be recorded. Span elements are defined to facilitate negotiation between buyer and provider.

7.1.1 Abstract Span Element

Span elements of **Intent Resource** have a common set of attributes that define the priority, data type and requested identity of the element. These common attributes are described in ▶ Table 7.4 Abstract Span Element. In addition, abstract span elements have at least four attributes that define the data type dependent aspects of the span. The data type of these values depends on the data type of the span and is defined in the following sections:

- @Actual – The intended value agreed to by the producer of the product.
- @OfferRange – A proposed range of equivalent values in cost that are defined by the producer of the product.
- @Preferred – A preferred value defined by the recipient of the product.
- @Range – A proposed range of values defined by the recipient of the product.

Table 7.4: Abstract Span Element

NAME	DATA TYPE	DESCRIPTION								
DataType	enumeration	Describes the data type of the span element within an Intent Resource . This attribute is provided for applications that do not have access to schema validation. Allowed values are:								
		<table border="0"> <tr> <td>DurationSpan</td> <td>OptionSpan</td> </tr> <tr> <td>EnumerationSpan</td> <td>ShapeSpan</td> </tr> <tr> <td>IntegerSpan</td> <td>StringSpan</td> </tr> <tr> <td>NameSpan</td> <td>TimeSpan</td> </tr> <tr> <td>NumberSpan</td> <td>XYPairSpan</td> </tr> </table>	DurationSpan	OptionSpan	EnumerationSpan	ShapeSpan	IntegerSpan	StringSpan	NameSpan	TimeSpan
DurationSpan	OptionSpan									
EnumerationSpan	ShapeSpan									
IntegerSpan	StringSpan									
NameSpan	TimeSpan									
NumberSpan	XYPairSpan									
Priority ? Deprecated in JDF 1.2	enumeration	Indicates the importance of the specific intent. Allowed values are: None Suggested – The customer will accept a value of @Actual that is different than the value of @Preferred or outside of @Range. Required – The customer expects the @Actual to be equal to @Preferred or within @Range. Note: The attribute @Preferred is available in the data types which inherit from this abstract type. Deprecation note: Starting with JDF 1.2, use @SettingsPolicy.								

7.1.2 Span Elements

The Data Type column of tables for **Intent Resource** (below) can contain the same data types as non-**Intent Resources** (namely data types defined in the ▶ Section 1.6 Data Structures) as well as span elements that are listed in the ▶ Table 7.5 List of Span Elements. In **Intent Resource** tables, **XXXSpan** elements are treated as attribute-like data types even though span elements are technically XML elements because the semantic usage of the span elements is equivalent to the usage of attributes in process resources.

Each span element contains attributes or subelements listed in ▶ Table 7.4 Abstract Span Element and in the pertinent span element listed in ▶ Table 7.5 List of Span Elements.

Table 7.5: List of Span Elements

NAME	PAGE	DESCRIPTION
DurationSpan New in JDF 1.1	page 294	Describes a set of duration values.
EnumerationSpan	page 294	Describes a set of enumeration values.
IntegerSpan	page 295	Describes a numerical range of integer values.
NameSpan	page 295	Describes a set of NMTOKEN values.
NumberSpan	page 296	Describes a numerical range of values.
OptionSpan	page 296	Describes an intent in which the principal information is that a specific option is requested.
ShapeSpan New in JDF 1.1	page 296	Describes a set of shape values.
StringSpan	page 297	Describes a set of string values.
TimeSpan	page 297	Describes a set of dateTime values.
XYPairSpan	page 298	Describes a set of XYPair values.

7.1.2.1 DurationSpan

New in JDF 1.1

This span subelement is used to describe a selection of instances in time. It inherits from the abstract span element described in ▶ Section 7.1.1 Abstract Span Element.

Table 7.6: DurationSpan Element

NAME	DATA TYPE	DESCRIPTION
Actual ?	duration	The actual value selected for the quote.
OfferRange ? New in JDF 1.3	DurationRange	Provides an offered range of time durations. If not specified, it defaults to the value of @Actual .
Preferred ?	duration	Provides a value specified by the person submitting the request, indicating what that person prefers. The value of @Preferred SHALL fall within the range of values specified in @Range .
Range ?	DurationRange	Provides a valid range of time durations. If not specified, it defaults to the value of @Preferred .

7.1.2.2 EnumerationSpan

This span subelement is used to describe ranges of enumerative values. It inherits from the abstract span element described in ▶ Section 7.1.1 Abstract Span Element. It is identical to the [NameSpan](#) element except for the fact that it describes a closed list of enumeration values.

Table 7.7: EnumerationSpan Element (Sheet 1 of 2)

NAME	DATA TYPE	DESCRIPTION
Actual ?	enumeration	The actual value selected for the quote.
OfferRange ? New in JDF 1.3	enumerations	Provides an offered range of values. Default value is from: @Actual .
Preferred ?	enumeration	Provides a value specified by the person submitting the request, indicating what that person prefers. The value of @Preferred SHALL fall within the range of values specified in @Range .

Table 7.7: EnumerationSpan Element (Sheet 2 of 2)

NAME	DATA TYPE	DESCRIPTION
<i>Range</i> ?	enumerations	Provides a set of discreet enumeration values. Default value is from: <i>@Preferred</i> .

Example 7.1: EnumerationSpan

```
<BindingIntent Class="Intent" ID="BI1" Status="Available">
  <BindingType Actual="Ring" DataType="EnumerationSpan"/>
  <RingBinding>
    <HoleType DataType="EnumerationSpan" Range="R4m-DIN-A5 R6m-DIN-A5">
      <Comment Name="R4m-DIN-A5">
        4 equidistant holes on each side of a hexagonal piece of paper
      </Comment>
      <Comment Name="R6m-DIN-A5">
        6 equidistant holes on each side of a hexagonal piece of paper
      </Comment>
    </HoleType>
  </RingBinding>
</BindingIntent>
```

7.1.2.3 IntegerSpan

This span subelement is used to describe ranges of integer values. It inherits from the abstract span element described in ▶ Section 7.1.1 Abstract Span Element.

Table 7.8: IntegerSpan Element

NAME	DATA TYPE	DESCRIPTION
<i>Actual</i> ?	integer	The actual value selected for the quote.
<i>OfferRange</i> ? New in JDF 1.3	IntegerRangeList	Provides either a set of individual values, a range of values or a combination of the two that comprise all offered values for the span. Default value is from: <i>@Actual</i> .
<i>Preferred</i> ?	integer	Provides a value specified by the person submitting the request, indicating what that person prefers. The value of <i>@Preferred</i> SHALL fall within the range of values specified in <i>@Range</i> .
<i>Range</i> ?	IntegerRangeList	Provides either a set of discreet values, a range of values or a combination of the two that comprise all allowed values for the span. Default value is from: <i>@Preferred</i> .

7.1.2.4 NameSpan

This span subelement is used to describe name ranges. It inherits from the abstract span element described in ▶ Section 7.1.1 Abstract Span Element. It is identical to the *EnumerationSpan* element except for the fact that it describes an extensible list of NMTOKEN values.

Table 7.9: NameSpan Element

NAME	DATA TYPE	DESCRIPTION
<i>Actual</i> ?	NMTOKEN	The actual value selected for the quote.
<i>OfferRange</i> ? New in JDF 1.3	NMTOKENS	Provides a set of discreet values that comprise all offered values for the span. Default value is from: <i>@Actual</i> .
<i>Preferred</i> ?	NMTOKEN	Provides a value specified by the person submitting the request, indicating what that person prefers. The value of <i>@Preferred</i> SHALL fall within the range of values specified in <i>@Range</i> .
<i>Range</i> ?	NMTOKENS	Provides a set of discreet values that comprise all allowed values for the span. Default value is from: <i>@Preferred</i> .

7.1.2.4.1 Specifying New Values in a NameSpan Subelement

NameSpan elements generally define an open list of predefined values. If a custom value is specified, a **Comment** element in the **NameSpan** defines the value with a **@Name** attribute in the **Comment**, as demonstrated in the following example:

7.1.2.5 NumberSpan

This span subelement is used to describe a numerical range of values. It inherits from the abstract span element described in ▶ Section 7.1.1 Abstract Span Element.

Table 7.10: NumberSpan Element

NAME	DATA TYPE	DESCRIPTION
<i>Actual</i> ?	double	The actual value selected for the quote.
<i>OfferRange</i> ? New in JDF 1.3	DoubleRangeList	Provides either a set of discreet values, a range of values or a combination of the two that comprise all offered values for the span. Default value is from: <i>@Actual</i> .
<i>Preferred</i> ?	double	Provides a value specified by the person submitting the request, indicating what that person prefers. The value of <i>@Preferred</i> SHALL fall within the range of values specified in <i>@Range</i> .
<i>Range</i> ?	DoubleRangeList	Provides either a set of discreet values, a range of values or a combination of the two that comprise all allowed values for the span. Default value is from: <i>@Preferred</i> .

7.1.2.6 OptionSpan

This span subelement is used to describe a range of options or boolean values. It inherits from the abstract span element described in ▶ Section 7.1.1 Abstract Span Element.

Table 7.11: OptionSpan Element

NAME	DATA TYPE	DESCRIPTION
<i>Actual</i> ?	boolean	The actual value selected for the quote. If the option is included="true".
<i>Detail</i> ? Deprecated in JDF 1.2	string	<i>@Detail</i> provides information about the option. Deprecation note: Starting with JDF 1.2, use <i>@DescriptiveName</i> .
<i>OfferRange</i> ? New in JDF 1.3	enumerations	Provides a set of the discreet boolean values. Default value is from: <i>@Actual</i> . Allowed values are: true false
<i>Preferred</i> ?	boolean	Provides a value specified by the person submitting the request, indicating what that person prefers.
<i>Range</i> ? New in JDF 1.2	enumerations	Provides a set of the discreet boolean values. Allowed values are: true false

7.1.2.7 ShapeSpan

New in JDF 1.1

This span subelement is used to describe ranges of numerical value pairs. It inherits from the abstract span element described in ▶ Section 7.1.1 Abstract Span Element.

Table 7.12: ShapeSpan Element (Sheet 1 of 2)

NAME	DATA TYPE	DESCRIPTION
<i>Actual</i> ?	shape	The actual value selected for the quote.

Table 7.12: ShapeSpan Element (Sheet 2 of 2)

NAME	DATA TYPE	DESCRIPTION
<i>OfferRange</i> ? New in JDF 1.3	ShapeRange-List	Provides either a set of discreet values, a range of values or a combination of the two that comprise all offered values for the span. Default value is from: @Actual.
<i>Preferred</i> ?	shape	Provides a value specified by the person submitting the request, indicating what that person prefers. The value of @Preferred SHALL fall within the range of values specified in @Range.
<i>Range</i> ?	ShapeRange-List	Provides either a set of discreet values, a range of values or a combination of the two that comprise all allowed values for the span. Default value is from: @Preferred.

7.1.2.8 StringSpan

This span subelement is used to describe string ranges. It inherits from the abstract span element described in ▶ Section 7.1.1 Abstract Span Element.

Table 7.13: StringSpan Element

NAME	DATA TYPE	DESCRIPTION
<i>Actual</i> ?	string	The actual value selected for the quote.
<i>Preferred</i> ?	string	Provides a value specified by the person submitting the request, indicating what that person prefers. The value of @Preferred SHALL fall within the range of values specified in @Range.
<i>OfferRange</i> * New in JDF 1.3	element	Provides a set of discreet values that comprise all offered values for the span. Default value is from: @Actual.
<i>Range</i> *	element	Provides a set of discreet values that comprise all allowed values for the span. Default value is from: @Preferred.

7.1.2.8.1 OfferRange

Table 7.14: OfferRange Element

NAME	DATA TYPE	DESCRIPTION
	text	Text content of the <i>OfferRange</i> .

7.1.2.8.2 Range

Table 7.15: Range Element

NAME	DATA TYPE	DESCRIPTION
	text	Text content of the <i>Range</i> .

7.1.2.9 TimeSpan

This span subelement is used to describe a selection of instances in time. It inherits from the abstract span element described in ▶ Section 7.1.1 Abstract Span Element.

Table 7.16: TimeSpan Element (Sheet 1 of 2)

NAME	DATA TYPE	DESCRIPTION
<i>Actual</i> ?	dateTime	The actual value selected for the quote.
<i>OfferRange</i> ? New in JDF 1.3	DateTimeRange	Provides a range of values that comprise all offered values for the span. Default value is from: @Actual.

Table 7.16: TimeSpan Element (Sheet 2 of 2)

NAME	DATA TYPE	DESCRIPTION
<i>Preferred</i> ?	dateTime	Provides a value specified by the person submitting the request, indicating what that person prefers. The value of @ <i>Preferred</i> SHALL fall within the range of values specified in @ <i>Range</i> .
<i>Range</i> ?	DateTimeRange	Provides a range of values that comprise all allowed values for the span. Default value is from: @ <i>Preferred</i> .

7.1.2.10 XYPairSpan

This span subelement is used to describe ranges of numerical value pairs. It inherits from the abstract span element described in ▶ Section 7.1.1 Abstract Span Element.

Table 7.17: XYPairSpan Element

NAME	DATA TYPE	DESCRIPTION
<i>Actual</i> ?	XYPair	The actual value selected for the quote.
<i>OfferRange</i> ? New in JDF 1.3	XYPair-RangeList	Provides either a set of discreet values, a range of values or a combination of the two that comprise all offered values for the span. Default value is from: @ <i>Actual</i> .
<i>Preferred</i> ?	XYPair	Provides a value specified by the person submitting the request, indicating what that person prefers. The value of @ <i>Preferred</i> SHALL fall within the range of values specified in @ <i>Range</i> .
<i>Range</i> ?	XYPair-RangeList	Provides either a set of discreet values, a range of values or a combination of the two that comprise all allowed values for the span. Default value is from: @ <i>Preferred</i> .

7.2 ArtDeliveryIntent

This resource specifies the prepress art delivery intent for a **JDF** job and maps the items to the appropriate reader pages and separations. Art delivery refers to any physical or electronic asset that is needed for processing the job.

Resource Properties

Resource Class Intent

Process Resource Pairing: *DeliveryParams*, *DigitalDeliveryParams*

Example Partition: "Option"

Table 7.18: ArtDeliveryIntent Resource (Sheet 1 of 2)

NAME	DATA TYPE	DESCRIPTION
<i>ArtDeliveryDate</i> ? New in JDF 1.1	TimeSpan	Specifies the latest time at which the transfer of the artwork will be made.
<i>ArtDeliveryDuration</i> ? New in JDF 1.1	DurationSpan	Specifies the latest time by which the transfer will be made relative to the date of the purchase order. Within an RFQ or a quote, at most one of either <i>ArtDeliveryDate</i> or <i>ArtDeliveryDuration</i> SHALL be specified. Within a purchase order, only <i>ArtDeliveryDate</i> is allowed.
<i>ArtHandling</i> ? New in JDF 1.1	EnumerationSpan	Describes what SHALL happen to the artwork after usage. The address for the "Return" and "Pickup" values SHALL be specified by a <i>Contact</i> [contains (@ <i>ContactTypes</i> , "ArtReturn")]/ <i>Address</i> . Allowed values are from: ▶ <i>ArtHandling</i> .
<i>DeliveryCharge</i> ? New in JDF 1.1 Modified in JDF 1.3	EnumerationSpan	Specifies who pays for a delivery being made by a third party. Allowed values are from: ▶ <i>DeliveryCharge</i> .
<i>Method</i> ? Modified in JDF 1.5	NameSpan	Specifies the delivery method, which can be a generic method. Values include those from: ▶ <i>Delivery Methods</i> .

Table 7.18: ArtDeliveryIntent Resource (Sheet 2 of 2)

NAME	DATA TYPE	DESCRIPTION
PreflightStatus = "NotPerformed" New in JDF 1.1 Modified in JDF 1.2	enumeration	Information about a Preflight process probably applied to the artworks prior to submission. Allowed value is from: ▶ PreflightStatus.
ReturnList ="None" New in JDF 1.1	NMTOKENS	Type of printer created intermediate materials that are to be sent to the customer after usage. Values include: DigitalMedia – Digital data on media (e.g., a CD). DigitalNetwork – Digital data via network. ExposedPlate – Pre-exposed press plates, usually used for a rerun. ImposedFilm – Film of the imposed surfaces. LooseFilm – Film of individual pages or sections. OriginalPhysicalArt – Analog artwork (e.g., reflective or transparencies). Tool – Tools needed for processing the job (e.g., a die for die cutting or embossing stamp). None – No intermediate materials are to be returned to the customer.
ReturnMethod ? New in JDF 1.1	NameSpan	Specifies a delivery method for returning the artwork if ArthHandling/@Actual ="Return" and for the printer created materials listed in ReturnList . Values include those from: ▶ Delivery Methods.
ServiceLevel ? New in JDF 1.2	StringSpan	The service level of the specific carrier. Values include those from: ▶ Service Levels.
Transfer ? New in JDF 1.1	EnumerationSpan	Describes the responsibility of the transfer. Allowed values are from: ▶ ArtTransfer.
ArtDelivery + Modified in JDF 1.1	element	Individual delivery.
Company ? Deprecated in JDF 1.1	refelement	Address and further information of the art delivery. Company SHALL NOT be specified unless the printer is expected to pick up the art delivery at this address. In JDF 1.1 and beyond, Company is a subelement of Contact .
Contact * New in JDF 1.1	refelement	Address and further information about the transfer of the artwork. The actual delivery address SHALL be specified by Contact [contains (@ContactTypes, "Delivery")]/ Address . At most one such Contact SHALL be specified. The actual pickup address SHALL be specified by Contact [contains (@ContactTypes, "Pickup")]/ Address . At most one such Contact SHALL be specified.

7.2.1 ArtDelivery

Each **ArtDelivery** element defines a set of existing products that are needed to create the specified product. Attributes that are specified in an **ArtDelivery** element overwrite those that are specified in their parent **ArtDeliveryIntent** element. If OPTIONAL attributes are not specified, their values default to the values specified in **ArtDeliveryIntent**.

Table 7.19: ArtDelivery Element (Sheet 1 of 3)

NAME	DATA TYPE	DESCRIPTION
Amount ? Modified in JDF 1.2	integer	Number of physical objects to be delivered. Only valid if no detailed resource description (e.g., ExposedMedia , RunList , ScanParams , DigitalMedia or Tool) is specified.
ArtDeliveryDate ? New in JDF 1.1	TimeSpan	Specifies the latest time by which the transfer of the artwork will be made.

Table 7.19: ArtDelivery Element (Sheet 2 of 3)

NAME	DATA TYPE	DESCRIPTION
ArtDeliveryDuration ? New in JDF 1.1	DurationSpan	Specifies the latest time by which the transfer will be made relative to the date of the purchase order. Within an RFQ or a quote, at most one of either ArtDeliveryDate or ArtDeliveryDuration SHALL be specified. Within a purchase order, only the ArtDeliveryDate is allowed.
ArtDeliveryType New in JDF 1.1 Modified in JDF 1.2	NMTOKEN	Type of artwork supplied. Values include: DigitalFile – Digital data irrespective of the delivery mechanism. The union of "DigitalMedia" and "DigitalNetwork". New in JDF 1.2 DigitalMedia – Digital data on media (e.g., a CD). DigitalNetwork – Digital data via network. ExposedPlate – Pre-exposed press plates, usually used for a rerun. ImposedFilm – Film of the imposed surfaces. LooseFilm – Film of individual pages or sections. OriginalPhysicalArt – Analog artwork (e.g., reflective or transparencies). Proof – Physical proof delivered with digital scan or separated film asset. Tool – Tools needed for processing the job (e.g., a die for die cutting or embossing stamp). None – No artwork exists, and it will be created later.
ArtHandling ? New in JDF 1.1	EnumerationSpan	Describes what SHALL happen to the artwork after usage. The address for the "Return" and "Pickup" values SHALL be specified by Contact [contains (@ContactTypes, "ArtReturn")]/Address. Default value is from: ArtDeliveryIntent/ArtHandling . Allowed values are from: ▶ ArtHandling.
DeliveryCharge ? New in JDF 1.1 Modified in JDF 1.3	EnumerationSpan	Specifies who pays for a delivery being made by a third party. Default value is from: ArtDeliveryIntent/DeliveryCharge . Allowed values are from: ▶ DeliveryCharge.
HasBleeds="false"	boolean	If "true", the file has bleeds.
IsTrapped="false"	boolean	If "true", the file has been trapped.
Method ? Modified in JDF 1.5	NameSpan	Specifies a delivery method. It MAY be a generic item from the list defined in @Method in ArtDeliveryIntent . Values include those from: ▶ Delivery Methods.
PageList ?	IntegerRangeList	Set of pages of the output Component that are filled by this ArtDelivery . This maps the pages in the ArtDelivery to the pages in the product that is produced. For example if PageList="3 ~ 5" , page 0 of the ArtDelivery (e.g., RunList) is page 3 in the product, page 1 is page 4, etc. If not specified, the @PageList SHALL include all pages in reader order. The indices specified in @PageList reference the PageData elements defined in PageList .
PreflightOutput ? New in JDF 1.1	URL	Pointer to the output information created by the preflight tool if @PreflightStatus is either "WithoutErrors" or "WithErrors".
PreflightStatus ? New in JDF 1.1	enumeration	Information about a Preflight process. Default value is from: ArtDeliveryIntent/@PreflightStatus . Allowed value is from: ▶ PreflightStatus.
ReturnMethod ? New in JDF 1.1	NameSpan	Specifies a delivery method for returning the artwork if ArtHandling/@Actual="Return" . Default value is from: ArtDeliveryIntent/ReturnMethod . Values include those from: ArtDeliveryIntent/ReturnMethod .
ServiceLevel ? New in JDF 1.2	StringSpan	The service level of the specific carrier. Values include those from: ▶ Service Levels.
Transfer ? New in JDF 1.1	EnumerationSpan	Describes the responsibility of the transfer. Default value is from: ArtDeliveryIntent/Transfer . Allowed values are from: ▶ ArtTransfer.

Table 7.19: ArtDelivery Element (Sheet 3 of 3)

NAME	DATA TYPE	DESCRIPTION
Company ? Deprecated in JDF 1.1	refelement	Address and further information about the art delivery. This SHALL NOT be specified unless the printer is expected to pick up the art delivery at this address. In JDF 1.1 and beyond, Company is a subelement of Contact .
Component ? Deprecated in JDF 1.1	refelement	Description of a physical component (e.g., physical artwork). If neither Component , ExposedMedia , nor RunList are specified, no details of the ArtDelivery except the @ArtDeliveryType and @Amount are known.
Contact * New in JDF 1.1	refelement	Address and further information about the art transfer. Default value is from: ArtDeliveryIntent/Contact.
DigitalMedia ? New in JDF 1.2	refelement	Description of any digital media (e.g., CD or tape with artwork that will be delivered). If neither ExposedMedia , RunList , DigitalMedia , nor Tool are specified, no details of the ArtDelivery except the @ArtDeliveryType and @Amount are known.
ExposedMedia ? Modified in JDF 1.2	refelement	Description of exposed media (e.g., film, plate or proof). If neither ExposedMedia , RunList , DigitalMedia , nor Tool are specified, no details of the ArtDelivery , except the @ArtDeliveryType and @Amount , are known.
RunList ? Modified in JDF 1.2	refelement	Link to digital artwork that is accessible via a set of URLs that are defined in the RunList/LayoutElement/FileSpec/@URL . If neither DigitalMedia , ExposedMedia , RunList , nor Tool are specified, no details of the ArtDelivery except the @ArtDeliveryType and @Amount are known.
ScanParams ?	refelement	Description of a ScanParams that defines scanning details for the exposed media defined by ExposedMedia .
Tool ? New in JDF 1.1 Modified in JDF 1.2	refelement	Details of the Tool if @ArtDeliveryType="Tool" . If neither ExposedMedia , RunList , DigitalMedia , nor Tool are specified, no details of the ArtDelivery except the @ArtDeliveryType and @Amount are known.

7.3 BindingIntent

This resource specifies the binding intent for a **JDF** job using information that identifies the desired type of binding and which sides SHALL be bound. The input products that are used as a cover SHALL have a **@ProductType** of "Cover", "FrontCover" or "BackCover". The input products that are used as a hardcover jacket SHALL have a **@ProductType** of "Jacket". Input components that are used as end sheets for hardcover or softcover binding SHALL have a **@ProductType** of "EndSheet". All other products are bound in the order of their appearance in the **ResourceLinkPool** of the **JDF** node that contains the **BindingIntent**.

Resource Properties

Resource Class Intent

Process Resource Pairing: **BlockPreparationParams, CaseMakingParams, CasingInParams, ChannelBindingParams, CoilBindingParams, CoverApplicationParams, EndSheetGluingParams, GlueApplication, GlueLine, GluingParams, InsertingParams, JacketingParams, PlasticCombBindingParams, RingBindingParams, SpinePreparationParams, SpineTapingParams, StitchingParams, StripBindingParams, ThreadSealingParams, ThreadSewingParams, WireCombBindingParams**

Example Partition: "Option"

Table 7.20: BindingIntent Resource (Sheet 1 of 3)

NAME	DATA TYPE	DESCRIPTION
BackCoverColor ? New in JDF 1.1	EnumerationSpan	Defines the color of the back cover material of the binding. Default value is from: @CoverColor. Allowed values are from: ▶ NamedColor.
BackCoverColorDetails ? New in JDF 1.4	StringSpan	A more specific, specialized or site-defined name for the color. If BackCoverColorDetails is supplied, BackCoverColor SHOULD also be supplied.
BindingColor ?	EnumerationSpan	Defines the color of the spine material of the binding. Allowed values are from: ▶ NamedColor.

Table 7.20: BindingIntent Resource (Sheet 2 of 3)

NAME	DATA TYPE	DESCRIPTION
BindingColorDetails ? New in JDF 1.4	StringSpan	A more specific, specialized or site-defined name for the color. If BindingColorDetails is supplied, BindingColor SHOULD also be supplied.
BindingLength ? Deprecated in JDF 1.6	EnumerationSpan	Indicates which side SHALL be bound when no content. Thus, no orientation is available, but a quote for binding is needed. Allowed values are: Long Short
BindingOrder = "Gathering" New in JDF 1.1 Modified in JDF 1.4	enumeration	Specifies whether the child Component resources are to be collected or gathered if multiple child Component resources are combined. Allowed values are: None – The products referenced by child product are NOT bound together. Typically used for flatwork jobs. New in JDF 1.4 Collecting – The products referenced by child product are collected on a spine and placed within one another. The first Component is on the outside. Gathering – The child Component resources are gathered on a pile and placed on top of one another. The first child product is on the top. List – More complex ordering of child Component resources is specified using the BindList in this intent resource for this product.
BindingSide ?	EnumerationSpan	@BindingSide indicates which side of the product SHALL be bound. Each of these values SHALL identify the binding edge. @BindingSide is defined in the coordinate system of the product. @BindingSide SHALL NOT be provided if @BindingOrder ="None". Constraint: If both @BindingSide and @BindingLength are specified, @BindingSide has precedence. Default value is from: @BindingLength , unless a non-empty BindList was specified. Allowed values are from: ▶ Edge.
BindingType ? Modified in JDF 1.2	EnumerationSpan	Describes the desired binding for the job. Allowed values are from: ▶ BindingType.
CoverColor ?	EnumerationSpan	Defines the color of the cover material of the binding. Allowed values are from: ▶ NamedColor.
CoverColorDetails ? New in JDF 1.4	StringSpan	A more specific, specialized or site-defined name for the color. If CoverColorDetails is supplied, CoverColor SHOULD also be supplied.
AdhesiveNote ? New in JDF 1.6	element	Details of AdhesiveNote binding.
AdhesiveBinding ? Deprecated in JDF 1.1	element	Details of AdhesiveBinding . Replaced with SoftCoverBinding in JDF 1.1.
BindList ? New in JDF 1.1	element	Details of binding of individual child Component resources.
BookCase ? Deprecated in JDF 1.1	element	Details of the book case. Used in combination with AdhesiveBinding , ThreadSewing or ThreadSealing . Replaced with HardCoverBinding in JDF 1.1.
ChannelBinding ?	element	Details of ChannelBinding .
CoilBinding ?	element	Details of CoilBinding .
EdgeGluing ? New in JDF 1.1	element	Details of EdgeGluing .
HardCoverBinding ? New in JDF 1.1	element	Details of HardCoverBinding .

Table 7.20: BindingIntent Resource (Sheet 3 of 3)

NAME	DATA TYPE	DESCRIPTION
PlasticCombBinding ?	element	Details of PlasticCombBinding .
RingBinding ?	element	Details of RingBinding .
SaddleStitching ?	element	Details of SaddleStitching .
SideSewing ?	element	Details of SideSewing .
SideStitching ?	element	Details of SideStitching .
SoftCoverBinding ? New in JDF 1.1	element	Details of SoftCoverBinding .
StripBinding ? New in JDF 1.1	element	Details of StripBinding .
Tabs ?	element	Details of Tabs .
Tape ? New in JDF 1.1	element	Details of Tape binding.
ThreadSealing ?	element	Details of ThreadSealing .
ThreadSewing ?	element	Details of ThreadSewing .
VeloBinding ? Deprecated in JDF 1.1	element	Details of VeloBinding . Renamed to StripBinding in JDF 1.1.
WireCombBinding ?	element	Details of WireCombBinding .

7.3.1 AdhesiveNote

New in JDF 1.6

Details of adhesive note binding.

Table 7.21: AdhesiveNote Element

NAME	DATA TYPE	DESCRIPTION
GlueLine ?	element	GlueLine provides details of the shape of the glue application and type of glue used.

7.3.2 BindList

New in JDF 1.1

[BindList](#) is used to describe complex bindings where more than one child is bound into a cover (e.g., in promotional products).

Table 7.22: BindList Element

NAME	DATA TYPE	DESCRIPTION
BindItem *	element	Individual bind item description.

7.3.3 BindItem

New in JDF 1.1

A child [BindItem](#) is bound to a parent item. The position of the spine of the child [BindItem](#) is defined by [@ChildFolio](#) and the position of the child [BindItem](#) in the parent is defined by [@ParentFolio](#).

Table 7.23: BindItem Element

NAME	DATA TYPE	DESCRIPTION
<i>BindingType</i> ?	EnumerationSpan	Describes the desired binding for the individual <i>BindItem</i> . Default value is from: <i>BindingIntent</i> . Allowed values are from: ▶ <i>BindingType</i> .
<i>ChildFolio</i> ?	XYPair	Definition of the fold between two pages in the <i>BindItem</i> component that is bound to the cover. The two numbers (as integers) in the <i>@ChildFolio</i> attribute are the page numbers of the two outer pages of the child <i>Component</i> which touch the cover or another parent <i>Component</i> . The pages are counted in the order as described in <i>LayoutIntent</i> / <i>@FolioCount</i> of the child product. Defaults to the spine of the child.
<i>ParentFolio</i>	XYPair	Definition of the fold between two pages in the cover <i>Component</i> that receive the <i>BindItem</i> . The two numbers (as integers) in the <i>@ParentFolio</i> attribute are the page numbers in the cover <i>Component</i> which touch the child <i>Component</i> . The pages are counted in the order as described in <i>LayoutIntent</i> / <i>@FolioCount</i> of the cover product.
<i>Transformation</i> ?	matrix	Rotation and offset between the <i>Component</i> to be inserted and the parent <i>Component</i> . For details on transformations, see ▶ Section 2.6.2 Coordinates and Transformations.
<i>WrapPages</i> ?	IntegerRangeList	List of pages of the cover that wrap around a <i>BindItem</i> after all folds are applied. It is sufficient to specify the pages of the "Front" partition of the cover (e.g. cover pages 1 and 4). Note: This attribute SHALL NOT be specified if the position of the cover can be derived from the folding information.
<i>ChannelBinding</i> ?	element	Details of <i>ChannelBinding</i> .
<i>CoilBinding</i> ?	element	Details of <i>CoilBinding</i> .
<i>EdgeGluing</i> ?	element	Details of <i>EdgeGluing</i> .
<i>HardCoverBinding</i> ?	element	Details of <i>HardCoverBinding</i> .
<i>PlasticCombBinding</i> ?	element	Details of <i>PlasticCombBinding</i> .
<i>RingBinding</i> ?	element	Details of <i>RingBinding</i> .
<i>SaddleStitching</i> ?	element	Details of <i>SaddleStitching</i> .
<i>SideSewing</i> ?	element	Details of <i>SideSewing</i> .
<i>SideStitching</i> ?	element	Details of <i>SideStitching</i> .
<i>SoftCoverBinding</i> ?	element	Details of <i>SoftCoverBinding</i> .
<i>StripBinding</i> ?	element	Details of <i>StripBinding</i> .
<i>Tabs</i> ?	element	Details of <i>Tabs</i> .
<i>Tape</i> ?	element	Details of <i>Tape</i> binding.
<i>ThreadSealing</i> ?	element	Details of <i>ThreadSealing</i> .
<i>ThreadSewing</i> ?	element	Details of <i>ThreadSewing</i> .
<i>WireCombBinding</i> ?	element	Details of <i>WireCombBinding</i> .

7.3.4 AdhesiveBinding

Deprecated in JDF 1.1

7.3.5 BookCase

Deprecated in JDF 1.1

7.3.6 ChannelBinding

Table 7.24: ChannelBinding Element

NAME	DATA TYPE	DESCRIPTION
ChannelBrand ? New in JDF 1.3	StringSpan	Strings providing available brand names for the ChannelBinding .
Cover ?	OptionSpan	If "true", the clamp used in ChannelBinding includes a preassembled cover.
Thickness ?	NumberSpan	Specifies thickness of board that is wrapped as front and back covers of a case bound book, in points.

7.3.7 CoilBinding

Table 7.25: CoilBinding Element

NAME	DATA TYPE	DESCRIPTION
CoilBrand ? New in JDF 1.3	StringSpan	Strings providing available brand names for the coil.
CoilMaterial ?	EnumerationSpan	The coil materials available for CoilBinding . Allowed values are from: ▶ BinderMaterial.
HoleList ? New in JDF 1.2	refelement	Details of the holes for coil binding.
HoleType ? New in JDF 1.6	EnumerationSpan	Predefined hole pattern that matches the binder. For details of the hole types, see the values. Allowed values are from: ▶ Appendix K Hole Pattern Catalog.

7.3.8 EdgeGluing

New in JDF 1.1

Table 7.26: EdgeGluing Element

NAME	DATA TYPE	DESCRIPTION
EdgeGlue ?	EnumerationSpan	Glue type used to glue the edge of the gathered sheets. Allowed values are from: ▶ Glue.

7.3.9 HardcoverBinding

New in JDF 1.1

Table 7.27: HardcoverBinding Element (Sheet 1 of 2)

NAME	DATA TYPE	DESCRIPTION
BlockThreadSewing ?	OptionSpan	Specified if the block is thread sewn.
CoverStyle ? New in JDF 1.3	NameSpan	Defines the style of the cover board. Values include: Simple – Single layer cover board, see ▶ Figure 7-1: Structure of a normal hardcover book. Padded – Padded cover board, see ▶ Figure 7-2: Structure of a padded hardcover book.
EndSheets ?	OptionSpan	Specified if end sheets are applied. Additional details of the EndSheets MAY be specified by supplying an input Component with @ProcessUsage with @ProductType="EndSheet" .

Table 7.27: HardCoverBinding Element (Sheet 2 of 2)

NAME	DATA TYPE	DESCRIPTION
HeadBands ?	OptionSpan	The following case binding choice specifies the use of head bands on a case bound book. If "true", head bands are inserted both top and bottom.
HeadBandColor ?	EnumerationSpanenumeration	Defines the color of the head band. Allowed values are from: ▶ NamedColor.
HeadBandColorDetails ? New in JDF 1.4	StringSpan	A more specific, specialized or site-defined name for the color. If HeadBandColorDetails is supplied, HeadBandColor SHOULD also be supplied.
Jacket ?	EnumerationSpan	Specifies whether a hardcover jacket is needed and how it is attached. Details of the jacket MAY be described in the Component with @ProcessUsage "Jacket". Allowed values are: None – No jacket is needed. Loose – The jacket is loosely wrapped. Glue – The jacket is glued to the spine.
JacketFoldingWidth ? New in JDF 1.3	NumberSpan	Dimension of the jacket folds. See JacketingParams for details.
JapanBind ?	OptionSpan	Bind the book block at the open edge, so that the folds are visible on the outside. If not specified, explicitly, this option is never selected.
SpineBrushing ?	OptionSpan	Brushing option for SpinePreparation .
SpineFiberRoughing ?	OptionSpan	Fiber roughing option for SpinePreparation .
SpineGlue ?	EnumerationSpan	Glue type used to glue the book block to the cover. Allowed values are from: ▶ Glue.
SpineLevelling ?	OptionSpan	Leveling option for SpinePreparation .
SpineMilling ?	OptionSpan	Milling option for SpinePreparation .
SpineNotching ?	OptionSpan	Notching option for SpinePreparation .
SpineSanding ?	OptionSpan	Sanding option for SpinePreparation .
SpineShredding ?	OptionSpan	Shredding option for SpinePreparation .
StripMaterial ?	EnumerationSpan	Spine taping strip material. Allowed values are from: ▶ StripMaterial.
Thickness ?	NumberSpan	Specifies the thickness of the board that is wrapped as front and back covers of a case bound book, in points.
TightBacking ?	EnumerationSpan	Definition of the geometry of the back of the book block. Allowed values are from: ▶ TightBacking.
RegisterRibbon *	refelement	Number, materials, colors and details of register ribbons.

Figure 7-1: Structure of a normal hardcover book

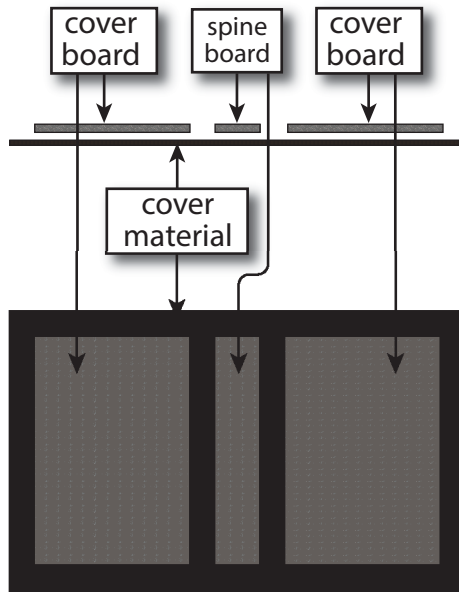
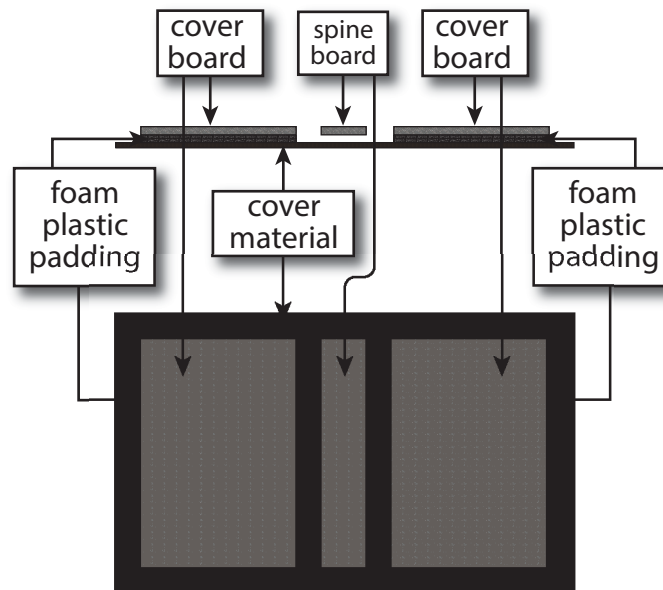

Figure 7-2: Structure of a padded hardcover book



7.3.10 PlasticCombBinding

Table 7.28: PlasticCombBinding Element (Sheet 1 of 2)

NAME	DATA TYPE	DESCRIPTION
CombBrand ? New in JDF 1.3	StringSpan	Strings providing available brand names for the plastic comb.

Table 7.28: PlasticCombBinding Element (Sheet 2 of 2)

NAME	DATA TYPE	DESCRIPTION
PlasticCombType ? Modified in JDF 1.1	NameSpan	The distance between the “teeth” in PlasticCombBinding and the distance between the holes of the pre-punched leaves SHALL be the same. The following values from the hole type catalog in ▶ Appendix K Hole Pattern Catalog exist: Values include: P12m-rect-02 – Distance = 12 mm; Holes = 7 mm x 3 mm P16_9i-rect-0t – Distance = 14.28 mm; Holes = 8 mm x 3 mm Euro – Distance = 12 mm; Holes = 7 mm x 3 mm Deprecated in JDF 1.1 USA1 – Distance = 14.28 mm; Holes = 8 mm x 3 mm. Deprecated in JDF 1.1
HoleList ? New in JDF 1.2	element	Details of the holes for the plastic comb. Note that @Shape is always rectangular by design of the plastic combs.
HoleType ? New in JDF 1.6	EnumerationSpan	Predefined hole pattern that matches the binder. For details of the hole types, see the values. Allowed values are from: ▶ Appendix K Hole Pattern Catalog.

7.3.11 RingBinding

Table 7.29: RingBinding Element (Sheet 1 of 2)

NAME	DATA TYPE	DESCRIPTION
BinderBrand ? New in JDF 1.3	StringSpan	Strings providing available brand names for RingBinding .
BinderMaterial ?	NameSpan	The following describe RingBinding binder materials used. Values include: Cardboard – Cardboard with no covering. ClothCovered – Cardboard with cloth covering. Plastic – Binder cover fabricated from solid plastic sheet material (e.g., PVC sheet). VinylCovered – Cardboard with colored vinyl covering.
HoleType ? New in JDF 1.1	EnumerationSpan	Predefined hole pattern for the ring system. Multiple hole patterns are not allowed (e.g., 3-hole ring binding and 4-hole ring binding holes on one piece of media). For details of the hole types, see the values. Allowed values are from: ▶ Appendix K Hole Pattern Catalog.
RingDiameter ?	NumberSpan	Size of the rings in points. The value used in production SHALL be suitable for specified values of HoleType . Note that in ring shapes other than round, this size is specified by industry-standard method.
RingMechanic ?	OptionSpan	The ring binder used includes a lever for opening and closing.
RingShape ?	NameSpan	RingBinding shapes. Values include: Round Oval D-shape SlantD
RingSystem ? Deprecated in JDF 1.1	NameSpan	Values include: 2HoleEuro 3HoleUS 4HoleEuro Deprecation note: Starting with JDF 1.1, use HoleType .
RivetsExposed ?	OptionSpan	The following RingBinding choice describes mounting of the ring mechanism in binder case. If "true", the heads of the rivets are visible on the exterior of the binder. If "false", the binder covering material covers the rivet heads.

Table 7.29: RingBinding Element (Sheet 2 of 2)

NAME	DATA TYPE	DESCRIPTION
ViewBinder ?	NameSpan	The values are RingBinding clear vinyl outer wrap types and are used on top of a colored base wrap. Values include: Embedded – Printed material is embedded by sealing between the colored and clear vinyl layers during binder manufacturing. Pocket – Binder is designed so that printed material can be inserted between the color and clear vinyl layers after binder manufacturing.

7.3.12 SaddleStitching

Table 7.30: SaddleStitching Element

NAME	DATA TYPE	DESCRIPTION
StapleShape ? New in JDF 1.6	EnumerationSpan	Specifies the shape of the staples to be used. Allowed values are from: ▶ StapleShape .
StitchNumber ? New in JDF 1.1	IntegerSpan-integer	Number of stitches used for saddle stitching.

7.3.13 SideSewing

This is a placeholder that might be filled with private or future data.

Table 7.31: SideSewing Element

NAME	DATA TYPE	DESCRIPTION

7.3.14 SideStitching

Table 7.32: SideStitching Element

NAME	DATA TYPE	DESCRIPTION
StapleShape ? New in JDF 1.6	EnumerationSpan	Specifies the shape of the staples to be used. Allowed values are from: ▶ StapleShape .
StitchNumber ? New in JDF 1.2	IntegerSpan	Number of stitches used for side stitching.

7.3.15 SoftCoverBinding

New in JDF 1.1

Table 7.33: SoftCoverBinding Element (Sheet 1 of 2)

NAME	DATA TYPE	DESCRIPTION
BlockThreadSewing ?	OptionSpan	Specifies whether the block is also thread sewn.
EndSheets ? New in JDF 1.3	OptionSpan	Specified if end sheets are applied. Additional details of the end sheets MAY be specified by supplying an input Component with <code>@ProcessUsage="EndSheet"</code> .
FoldingWidth ? New in JDF 1.3	NumberSpan	Definition of the dimension of the folding width of the front cover fold. See JacketingParams for details.

Table 7.33: *SoftCoverBinding Element (Sheet 2 of 2)*

NAME	DATA TYPE	DESCRIPTION
FoldingWidthBack ? New in JDF 1.3	NumberSpan	Definition of the dimension of the folding width of the back cover fold. If not specified, FoldingWidthBack defaults to FoldingWidth .
GlueProcedure ?	EnumerationSpan	Glue procedure used to glue the book block to the cover. Allowed values are: Spine SideOnly – Glued at the side or end sheets but not at the spine. "SideOnly" books are also referred to as "layflat" if EndSheets is also specified. See ▶ Figure 7-3: Structure of a book with GlueProcedure = "SideOnly" (Layflat). SingleSide – Swiss brochure. SideSpine – Both side gluing and spine gluing.
Scoring ?	EnumerationSpan	Scoring option for SoftCoverBinding . Values are based on viewing the cover in its flat, pre-bound state. Allowed values are: TwiceScored QuadScored None
SpineBrushing ?	OptionSpan	Brushing option for SpinePreparation .
SpineFiberRoughing ?	OptionSpan	Fiber roughing option for SpinePreparation .
SpineGlue ?	EnumerationSpan	Glue type used to glue the book block to the cover. Allowed values are from: ▶ Glue.
SpineLevelling ?	OptionSpan	Leveling option for SpinePreparation .
SpineMilling ?	OptionSpan	Milling option for SpinePreparation .
SpineNotching ?	OptionSpan	Notching option for SpinePreparation .
SpineSanding ?	OptionSpan	Sanding option for SpinePreparation .
SpineShredding ?	OptionSpan	Shredding option for SpinePreparation .

Figure 7-3: Structure of a book with **GlueProcedure** = "SideOnly" (Layflat)

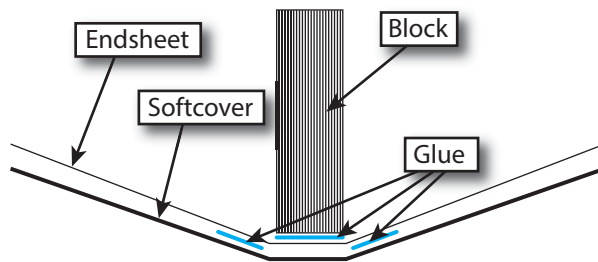

7.3.16 StripBinding

New in JDF 1.1

Table 7.34: *StripBinding Element (Sheet 1 of 2)*

NAME	DATA TYPE	DESCRIPTION
HoleList ? New in JDF 1.2	refelement	Note that @Shape is always round by design of the strip poles.

Table 7.34: StripBinding Element (Sheet 2 of 2)

NAME	DATA TYPE	DESCRIPTION
HoleType ? New in JDF 1.6	EnumerationSpan	Predefined hole pattern that matches the binder. For details of the hole types, see the values. Allowed values are from: ▶ Appendix K Hole Pattern Catalog.

7.3.17 Tabs

Specifies tabs in a bound document.

Table 7.35: Tabs Element

NAME	DATA TYPE	DESCRIPTION
TabBanks="1" Deprecated in JDF 1.4	integer	Number of rows of tabs on the face of the book. Deprecation note: Starting with JDF 1.4, @TabBanks should be calculated from @TabCount and @TabsPerBank .
TabBrand ? New in JDF 1.3	StringSpan	Strings providing available brand names for the Tabs .
TabCount ? New in JDF 1.4	integer	Number of tabs across all banks. If @TabsPerSet is not an even multiple of @TabsPerBank , the last bank in each set is partially filled.
TabsPerBank ?	integer	Number of equal-sized tabs in a single bank if all positions were filled. Note that banks can have tabs only in some of the possible positions
TabExtensionDistance ?	NumberSpan	Distance tab extends beyond the body of the book block, in points.
TabExtensionMylar ?	OptionSpan	If "true", the tab extension will be mylar reinforced.
TabBindMylar ?	OptionSpan	If "true", the tab bind edge will be mylar reinforced.
TabBodyCopy ?	OptionSpan	If "true", color will be applied not only on tab extension, but also on tab body. Note: The lack of body copy allows all tabs within a bank to be printed on a single sheet.
TabMylarColor ?	EnumerationSpan	Specifies the color of the mylar used to reinforce the tab extension. This is conditional on TabExtensionMylar being "true". Allowed values are from: ▶ NamedColor
TabMylarColorDetails ? New in JDF 1.4	StringSpan	A more specific, specialized or site-defined name for the color. If TabMylarColorDetails is supplied, TabMylarColor SHOULD also be supplied.

7.3.18 Tape

New in JDF 1.1

Table 7.36: Tape Element

NAME	DATA TYPE	DESCRIPTION
TapeColor ? Deprecated in JDF 1.4	EnumerationSpan	Defines the color of the tape material of the binding. Allowed values are from: ▶ NamedColor. Deprecation note: Starting with JDF 1.4, use BindingIntent/@BindingColor .

7.3.19 ThreadSealing

This is a placeholder that might be filled with private or future data.

Table 7.37: ThreadSealing Element

NAME	DATA TYPE	DESCRIPTION

7.3.20 ThreadSewing

Table 7.38: ThreadSewing Element

NAME	DATA TYPE	DESCRIPTION
Sealing ?	OptionSpan	If "true", thermo-sealing is needed in ThreadSewing .

7.3.21 WireCombBinding

Table 7.39: WireCombBinding Element

NAME	DATA TYPE	DESCRIPTION
WireCombBrand ? New in JDF 1.3	StringSpan	Strings providing available brand names for the WireCombBinding .
WireCombMaterial ?	EnumerationSpan	The material used for forming the WireCombBinding . Allowed values are: Steel-Silver ColorCoatedSteel
WireCombShape ? Modified in JDF 1.6	NameSpan	The shape of the wire comb. Values include: Single – Each “tooth” is made with one wire. SingleCalendar – Each “tooth” is made with one wire and an extension for hanging the bound product is provided in the center. New in JDF 1.6 Twin – The shape of each “tooth” is made with a double wire. TwinCalendar – The shape of each “tooth” is made with a double wire and an extension for hanging the bound product is provided in the center. New in JDF 1.6
HoleList ? New in JDF 1.2	refelement	Details of the holes for the wire comb.
HoleType ? New in JDF 1.6	EnumerationSpan	Predefined hole pattern that matches the binder. For details of the hole types, see the values. Allowed values are from: ▶ Appendix K Hole Pattern Catalog.

7.4 ColorIntent

This resource specifies the type of ink to be used. Typically, the parameters consist of a manufacturer name and additional identifying information. The resource also specifies any coatings and colors to be used, including the process color model and any spot colors.

In addition to the printed images, [ColorIntent](#) also provides details of protective or gloss enhancing coatings. Customers may either specify the performance characteristic they desire in the coating or specify a coating type. Common examples are water-resistance, and rub-resistance. Both characteristics may be required at the same time. An example is in the wine industry, where the white wine label has to survive transport rubbing, followed by water and rubbing ice cubes in a bucket upon serving.

Resource Properties

Resource Class: Intent

Process Resource Pairing: [Color](#), [ColorantControl](#), [ColorCorrectionParams](#), [ColorPool](#), [ColorSpaceConversionParams](#), [Ink](#), [VarnishingParams](#)

Example Partition: "Option", "PageNumber", "Side"

Table 7.40: ColorIntent Resource (Sheet 1 of 2)

NAME	DATA TYPE	DESCRIPTION
Coatings ? Modified in JDF 1.5	StringSpan	Material usually applied to a full surface on press as a protective or gloss-enhancing layer over ink. Values include those from: ▶ Ink and Varnish Coatings.

Table 7.40: ColorIntent Resource (Sheet 2 of 2)

NAME	DATA TYPE	DESCRIPTION
<p>ColorICCStandard ? New in JDF 1.2</p>	<p>StringSpan</p>	<p>ColorICCStandard can be used to identify a specific standard printing condition, by reference to characterization data registered with the ICC, see ▶ [Characterization Data]. This printing condition reference corresponds to the output intent characterization referencing capability in PDF/X. The syntax will be reference name as shown in the examples below. Reference name is the standard reference string name used in both JDF and PDF/X, defined for each printing condition in the characterization registry on the ICC website.</p> <p>Values include:</p> <p>FOGRA11 – Registered by FOGRA pertaining to offset commercial and specialty printing according to ▶ [ISO12647-2:2004], positive plates, paper type 1 (gloss-coated, above 70 g/m²) and paper type 2 (matte-coated, above 70 g/m²), screen frequency 60/cm. Appropriate for black-backing measurement.</p> <p>FOGRA15 – Registered by FOGRA pertaining to offset commercial and specialty printing according to ▶ [ISO12647-2:2004], positive plates, paper type 1 (gloss-coated, above 70 g/m²) and paper type 2 (matte-coated, above 70 g/m²), screen frequency 60/cm. Appropriate for self-backing measurement.</p> <p>CGATS TR001 – pertaining to printing conditions that conform to ANSI CGATS.6, which addresses publication printing in the US as defined by SWOP.</p> <p>Note: If both of ColorICCStandard or are specified, the union of the two is specified. If both of ColorICCStandard and ColorStandard are specified, then ColorICCStandard defines the ICC specific details, whereas ColorStandard defines the generic color standard.</p>
<p>ColorStandard ? Modified in JDF 1.2</p>	<p>NameSpan</p>	<p>The color process (i.e., printing condition) requested for the job. ColorStandard does not imply values for ColorsUsed. For instance, if ColorStandard is "CMYK", ColorsUsed SHALL still contain the four process colors "Cyan", "Magenta", "Yellow" and "Black". If both of ColorICCStandard and ColorStandard are specified, then ColorICCStandard defines the ICC specific details, whereas ColorStandard defines the generic color standard.</p> <p>Values include those from: ▶ Table 7.41 ColorStandard Attribute Values.</p>
<p>Coverage ?</p>	<p>NumberSpan</p>	<p>Cumulative colorant coverage percentage. For example, a full sheet of 100% deep black in CMYK has Coverage/@Actual="400". Typical coverages based on one color plane are:</p> <p>Light – 1-9%</p> <p>Medium – 10-35%</p> <p>Heavy – 36+%</p>
<p>InkManufacturer ? Deprecated in JDF 1.2</p>	<p>NameSpan</p>	<p>Name of the manufacturer of the ink requested (e.g., "ACMEInk", "CIP4_Ink_Company", etc.).</p>
<p>NumColors ? New in JDF 1.5</p>	<p>integer</p>	<p>@NumColors specifies the number of colors (Inks) used for a product. A value of 0 implies no printing. A value of 1 implies black. A value of 4 implies CMYK. Spot colors SHALL be specified in @ColorsUsed.</p> <p>If both @NumColors and @ColorsUsed are specified, the sum of both is requested (e.g., @NumColors="4" and @ColorsUsed="Spot1" defines a CMYK product with one additional spot color).</p>
<p>ColorPool ? New in JDF 1.1</p>	<p>refelement</p>	<p>Additional details about the colors used. The ColorPool resource may include some or all details about both ColorsUsed separation spot colors, spot colors contained in job files that will be printed using process color equivalents and the ColorStandard process colors.</p>
<p>ColorsUsed ?</p>	<p>element</p>	<p>Array of colorant separation names that are requested. If not specified, the values are implied from ColorStandard. If specified, ColorsUsed SHALL contain a list of all separation names used by the job.</p> <p>Note: If additional information about the colors and colorants is needed, it can be specified in the referenced ColorPool resource.</p>

Table 7.41: ColorStandard Attribute Values

VALUE	DESCRIPTION
CMYK	Generic four color process.
FIRST	Flexographic Image Reproduction Specifications & Tolerances.
GRACOL	General Requirements for Applications in Commercial Offset Lithography
Hexachrome	6 colors "CMYK" + "Orange" and "Green".
HIFI	7 colors "CMYK" + "Red", "Green" and "Blue".
ISO12647 Deprecated in JDF 1.2	▶ [ISO12647-2:2004] offset standard.
JapanColor2001	Japan Color 2001 standard ▶ [japancolor].
Monochrome	Generic single color printing condition (e.g., black and white or one single spot color).
None Deprecated in JDF 1.2	No marks. Used to define one-sided printing. Deprecation note: Starting with JDF 1.2, use LayoutIntent/@Sides instead.
SNAP	Specifications for Newsprint Advertising Production
SWOP	Specifications for Web Offset Publications. Registered by ANSI with the ICC as ICC:CGATS TR001 pertaining to printing conditions that conform to ANSI CGATS.6 which is based on publication printing in the US as defined by SWOP, Inc.

7.4.1 ColorsUsed

Table 7.42: ColorsUsed Element

NAME	DATA TYPE	DESCRIPTION
SeparationSpec * Modified in JDF 1.2	element	<p>These can be process colors, generic spot colors or named spot colors. In addition, partial (spot) coating is specified by adding a SeparationSpec with anything from Coatings as SeparationSpec/@Name:</p> <p>Aqueous Bronzing DullVarnish GlossVarnish SatinVarnish Silicone Spot – Generic spot color of which the details are unknown. Spot MAY be specified multiple times in one ColorsUsed element. New in JDF 1.2 UV Varnish – Generic varnish including "DullVarnish", "GlossVarnish" and "SatinVarnish". New in JDF 1.3</p>

7.5 DeliveryIntent

Summarizes the options that describe pickup or delivery time and location of the [PhysicalResources](#) of a job. It also defines the number of copies that are requested for a specific job or delivery. This includes delivery of both final products and of proofs. [DeliveryIntent](#) MAY also be used to describe the delivery of intermediate products such as partial products in a subcontracting description

Resource Properties

Resource Class: Intent

Process Resource Pairing: [Address](#), [DeliveryParams](#)

Example Partition: "Option"

Table 7.43: DeliveryIntent Resource (Sheet 1 of 2)

NAME	DATA TYPE	DESCRIPTION
<i>Accepted ?</i> Deprecated in JDF 1.3	boolean	The quote that is specified by this <i>DeliveryIntent</i> has been accepted. Deprecation note: Starting with JDF 1.3 , contract negotiation information has been removed and will be handled by the business wrapper around JDF (e.g., PrintTalk).
<i>AdditionalAmount="1"</i> New in JDF 1.2 Deprecated in JDF 1.3	integer	Number of components used to calculate the value of the <i>@AdditionalPrice</i> attribute in the <i>Pricing</i> . This value applies to the number of additional items in one <i>DroplIntent/DropitemIntent</i> and not to the total additional number of items. In JDF 1.3 and beyond, pricing information has been removed and will be handled by the business wrapper around JDF (e.g., PrintTalk).
<i>BuyerAccount ?</i>	string	Account ID of the buyer with the delivery service.
<i>DeliveryCharge ?</i> New in JDF 1.1 Modified in JDF 1.2	EnumerationSpan	Specifies who pays for a delivery being made by a third party. Allowed values are from: ▶ DeliveryCharge.
<i>Earliest ?</i>	TimeSpan	Specifies the earliest time after which the transfer SHALL be made. Within an RFQ or a quote, at most one of <i>Earliest</i> or <i>EarliestDuration</i> SHALL be specified.
<i>EarliestDuration ?</i>	DurationSpan	Specifies the earliest time by which the transfer SHALL be made relative to the date of the purchase order. Within an RFQ or a quote, at most one of <i>Earliest</i> or <i>EarliestDuration</i> SHALL be specified. Within a purchase order, <i>EarliestDuration</i> SHALL NOT be specified.
<i>Method ?</i> Modified in JDF 1.5	NameSpan	Specifies a delivery method, which can be a generic method. Values include those from: ▶ Delivery Methods.
<i>Overage ?</i>	NumberSpan	Percentage value that defines the acceptable upwards variation of <i>@Amount</i> . Defaults to the trade custom defaults as defined by PIA, BVD, etc.
<i>Ownership="Origin"</i>	enumeration	Point of transfer of ownership: Allowed values are: <i>Origin</i> – Ownership of goods is transferred upon leaving point of origin. <i>Destination</i> – Ownership is transferred upon receipt at destination.
<i>Pickup ?</i> Deprecated in JDF 1.1	boolean	Specifies whether the delivery brings or picks up the merchandise. If <i>@Pickup="false"</i> , the drop is delivered to the address specified in <i>Company</i> . If <i>@Pickup="true"</i> , the <i>DeliveryIntent</i> describes an input to the job (e.g., a CD for inserting, a preprinted cover, etc.). In this case <i>Company</i> describes the location where the merchandise is picked up.
<i>Required ?</i>	TimeSpan	Specifies the time by which the transfer SHALL be made. Within an RFQ or a quote, exactly one of <i>Required</i> or <i>RequiredDuration</i> SHALL be specified.
<i>RequiredDuration ?</i>	DurationSpan	Specifies the time by which the transfer SHALL be made relative to the date of the purchase order. Within an RFQ or a quote, exactly one of <i>Required</i> or <i>RequiredDuration</i> SHALL be specified. Within a purchase order, <i>RequiredDuration</i> SHALL NOT be specified.
<i>ReturnMethod ?</i> New in JDF 1.1	NameSpan	Specifies a delivery method for returning the surplus material and SHALL NOT be specified unless <i>SurplusHandling="Return"</i> . Values include those from: ▶ Delivery Methods.
<i>ServiceLevel ?</i> New in JDF 1.2	StringSpan	The service level of the specific carrier. Values include those from: ▶ Service Levels.
<i>SurplusHandling ?</i> New in JDF 1.1	EnumerationSpan	Describes what SHALL happen with unused or redundant parts of the transfer specified with <i>Transfer="BuyerToPrinterDeliver"</i> or <i>"BuyerToPrinterPickup"</i> after the job. The return delivery or pickup address is specified by <i>Contact</i> [contains (<i>@ContactTypes</i> , " <i>SurplusReturn</i> ")]. Allowed values are from: ▶ SurplusHandling.

Table 7.43: DeliveryIntent Resource (Sheet 2 of 2)

NAME	DATA TYPE	DESCRIPTION
Transfer ? New in JDF 1.1	EnumerationSpan	Describes the direction and responsibility of the transfer. Allowed values are from: Drop/Transfer.
Underage ?	NumberSpan	Percentage value that defines the acceptable downwards variation of @Amount. Defaults to the trade custom defaults as defined by PIA, BVD, etc. The value SHALL be nonnegative.
Company ? Deprecated in JDF 1.1	reference	Address and further information of the addressee. In JDF 1.1 and beyond, Company is referenced from Contact .
Contact * New in JDF 1.1	reference	Address and further information of the Contact responsible for the transfer. The actual delivery address is specified as the Contact [contains (@ContactTypes, "Delivery")]/ Address . The actual pickup address is specified as the Contact [contains (@ContactTypes, "Pickup")]/ Address . At most one Contact [contains (@ContactTypes, X)] SHALL be specified for X equal to "Delivery", "Pickup" or "Billing",
Droplntent +	element	Includes all locations where the product will be delivered. Note that multiple Droplntent elements specify multiple deliveries and not options for delivery.
FileSpec (DeliveryContents) ? New in JDF 1.6	reference	Reference to a document to that SHALL be printed and packaged together with the delivered items of this Drop .
FileSpec (MailingList) ?	reference	A FileSpec resource pointing to a mailing list. The format of the referenced mailing list is implementation dependent.
Pricing ? Deprecated in JDF 1.3	element	Pricing elements that define the pricing of the complete DeliveryIntent including any Droplntent or Droplntent elements that MAY contain further Pricing elements. In JDF 1.3 and beyond, pricing information has been removed and will be handled by the business wrapper around JDF (e.g., PrintTalk).

This element contains information about the intended individual drop of a delivery. Attributes that are specified in a **Droplntent** element overwrite those that are specified in their parent **DeliveryIntent** element. If OPTIONAL values are not specified, they default to the values specified in the **DeliveryIntent**.

7.5.1 Droplntent

Table 7.44: Droplntent Element (Sheet 1 of 2)

NAME	DATA TYPE	DESCRIPTION
AdditionalAmount ? New in JDF 1.2 Deprecated in JDF 1.3	integer	Number of components used to calculate the value of the @AdditionalPrice attribute in the Pricing . This value applies to the number of additional items in one Droplntent/Droplntent and not to the total additional number of items. If not specified, defaults to the value of DeliveryIntent/AdditionalAmount . In JDF 1.3 and beyond, pricing information has been removed and will be handled by the business wrapper around JDF (e.g., PrintTalk).
BuyerAccount ? New in JDF 1.2	string	Account ID of the buyer with the delivery service. Default value is from: DeliveryIntent/BuyerAccount
DropID ? New in JDF 1.5	string	Droplntent elements with the same @DropID are part of the same drop. This attribute is provided to allow items from multiple individual JDF jobs to be delivered in one drop.
Earliest ?	TimeSpan	Specifies the earliest time after which the transfer SHALL be made. Within an RFQ or a quote, at most one of Earliest or EarliestDuration SHALL be specified.
EarliestDuration ?	DurationSpan	Specifies the earliest time by which the transfer SHALL be made relative to the date of the purchase order. Within an RFQ or a quote, at most one of Earliest or EarliestDuration SHALL be specified. Within a purchase order, EarliestDuration SHALL NOT be specified.

Table 7.44: DropIntent Element (Sheet 2 of 2)

NAME	DATA TYPE	DESCRIPTION
Method ? Modified in JDF 1.5	NameSpan	Specifies a delivery method. Values include those from: ▶ Delivery Methods.
Pickup ? Deprecated in JDF 1.1	boolean	If "true", the merchandise is picked up. If @Pickup="false", the DropIntent is delivered to the address specified in Company . If @Pickup="true", the DropIntent describes an input to the job (e.g., a CD for inserting, a preprinted cover, etc.). In this case, Company describes the location where the merchandise is picked up.
Required ?	TimeSpan	Specifies the time by which the delivery SHALL be made. Within an RFQ or a quote, at most one of Required or RequiredDuration SHALL be specified.
RequiredDuration ?	DurationSpan	Specifies the time by which the delivery SHALL be made relative to the date of the purchase order. Within an RFQ or a quote, at most one of Required or RequiredDuration SHALL be specified. Within a purchase order, RequiredDuration SHALL NOT be specified.
ReturnMethod ? New in JDF 1.1	NameSpan	Specifies a delivery method for returning the surplus material, and SHALL NOT be specified unless SurplusHandling ="Return". Default value is from: DeliveryIntent/ReturnMethod . Values include those from: ▶ Delivery Methods.
ServiceLevel ? New in JDF 1.2	StringSpan	The service level of the specific carrier. Values include those from: ▶ Service Levels.
SurplusHandling ? New in JDF 1.1	EnumerationSpan	Describes what SHALL happen with unused or redundant parts of the transfer. Default value is from: DeliveryIntentSurplusHandling . Allowed values are from: ▶ SurplusHandling.
Transfer ? New in JDF 1.1	EnumerationSpan	Describes the direction and responsibility of the transfer. Allowed values are from: Drop/@Transfer .
Company ? Deprecated in JDF 1.1	refelement	Address and further information of the addressee. In JDF 1.1 and beyond Company is a subelement of Contact .
Contact * New in JDF 1.1	refelement	Address and further information of the Contact responsible for the transfer. The actual delivery address is specified as the Contact [contains (@ContactTypes, "Delivery")]/ Address . The actual pickup address is specified as the Contact [contains (@ContactTypes, "Pickup")]/ Address . At most one Contact [contains (@ContactTypes, X)]/ SHALL be specified for X equal to "Delivery", "Pickup" or "Billing". Defaults to the DeliveryIntent/Contact
DropItemIntent +	element	A DropIntent MAY consist of multiple products that are represented by their respective PhysicalResource elements. Each DropItemIntent element describes a number of individual resources that is part of this DropIntent .
FileSpec (DeliveryContents) ? New in JDF 1.6	refelement	Reference to a document to that SHALL be printed and packaged together with the delivered items of this Drop .
Pricing ? Deprecated in JDF 1.3	element	Pricing element that defines the pricing of the DropIntent . In JDF 1.3 and beyond, pricing information has been removed and will be handled by the business wrapper around JDF (e.g., PrintTalk).

7.5.2 DropltemIntent

Table 7.45: DropltemIntent Element

NAME	DATA TYPE	DESCRIPTION
<i>AdditionalAmount</i> ? Modified in JDF 1.2 Deprecated in JDF 1.3	integer	Number of components used to calculate the value of the <i>@AdditionalPrice</i> attribute in the <i>Pricing</i> . If not specified, defaults to the value of <i>DropltemIntent/@AdditionalAmount</i> . In JDF 1.3 and beyond, pricing information has been removed and will be handled by the business wrapper around JDF (e.g., PrintTalk).
<i>Amount</i> ?	integer	Specifies the final number of resources delivered. If not specified, defaults to the total amount of the resource that is specified by <i>PhysicalResources</i> or 1 if this <i>DropltemIntent</i> specifies a proof. Note that <i>DropltemIntent/@Amount</i> corresponds semantically to <i>ResourceLink/@ActualAmount</i> and <i>Dropltem/@ActualAmount</i> .
<i>DropID</i> ? New in JDF 1.5	string	<i>DropltemIntent</i> elements with the same <i>@DropID</i> are part of the same drop. This attribute is provided to allow items from multiple individual JDF jobs to be delivered in one drop.
<i>OrderedAmount</i> ?	integer	Specifies the original number of resources ordered. If not specified, defaults to the value of <i>@Amount</i> . Note that <i>DropltemIntent/@OrderedAmount</i> corresponds semantically to <i>ResourceLink/@Amount</i> and <i>Dropltem/@Amount</i> .
<i>Proof</i> ? New in JDF 1.1	string	This <i>DropltemIntent</i> refers to a proof that is specified in a <i>ProofItem</i> of the <i>ProofingIntent</i> of this product intent node. Constraint: <i>ProofingIntent/ProofItem/@ProofName</i> SHALL match <i>@Proof</i> . Exactly one of <i>PhysicalResource</i> or <i>@Proof</i> SHALL be specified.
<i>Unit</i> ? Deprecated in JDF 1.6	string	Unit of measurement for the <i>@Amount</i> specified in the <i>PhysicalResources</i> . If not specified, then the value from the resource described by <i>PhysicalResource/@Unit</i> is used.
<i>PhysicalResource</i> ? Modified in JDF 1.1	refelement	Description of the individual item that is delivered. Constraint: exactly one of <i>PhysicalResource</i> or <i>@Proof</i> SHALL be specified. Note: <i>PhysicalResource</i> represents a resource that SHALL be an instance of a <i>PhysicalResource</i> (e.g., <i>Component</i>).
<i>Pricing</i> ? Deprecated in JDF 1.3	element	<i>Pricing</i> element that defines the pricing of the <i>DropltemIntent</i> . Deprecation note: Starting with JDF 1.3 , pricing information has been removed and will be handled by the business wrapper around JDF (e.g., PrintTalk).

7.5.3 Pricing

Deprecated in JDF 1.3

7.5.4 Payment

Deprecated in JDF 1.3

7.5.5 CreditCard

Deprecated in JDF 1.3

7.6 EmbossingIntent

New in JDF 1.1

This resource specifies the embossing and/or foil stamping intent for a **JDF** job using information that identifies whether the product is embossed or stamped, and if desired, the complexity of the affected area.

Resource Properties

Resource Class: Intent

Process Resource Pairing: *EmbossingParams*

Example Partition: "Option", "PageNumber", "Side"

Table 7.46: EmbossingIntent Resource

NAME	DATA TYPE	DESCRIPTION
EmbossingItem +	element	Each embossed image is described by one EmbossingItem .

7.6.1 EmbossingItem

Table 7.47: EmbossingItem Element

NAME	DATA TYPE	DESCRIPTION
Direction Modified in JDF 1.3	EnumerationSpan	The direction of the image. Allowed values are from: ▶ EmbossDirection.
EdgeAngle ?	NumberSpan	The angle of a beveled edge in degrees. Typical values are an angle of: 30, 40, 45, 50 or 60 degrees. If EdgeAngle is specified, EdgeShape ="Beveled" SHALL be specified.
EdgeShape ?	EnumerationSpan	The transition between the embossed surface and the surrounding media can be rounded or beveled (angled). Allowed values are: Rounded Beveled
EmbossingType Modified in JDF 1.4	StringSpan	The embossing type required. The strings defined in EmbossingType are whitespace separated combinations of the following tokens. Allowed values are from: ▶ EmbossType.
FoilColor ?	EnumerationSpan	Defines the color of the foil material that is used for embossing. Allowed values are from: ▶ NamedColor.
FoilColorDetails ? New in JDF 1.4	StringSpan	A more specific, specialized or site-defined name for the color. If FoilColorDetails is supplied, FoilColor SHOULD also be supplied. FoilColorDetails SHOULD be used to specify specialized foil properties such as holographic or transparent foils. Example combinations of FoilColor and FoilColorDetails include: Holographic foils: @FoilColor="Silver" and @FoilColorDetails="Holographic". Matte transparent foil: @FoilColor="White" and @FoilColorDetails="TransparentMatte".
Height ?	NumberSpan	The height of the levels. This value specifies the vertical distance between the highest and lowest point of the stamp, regardless of the value of Direction .
ImageSize ?	XYPairSpan	The size of the bounding box of one single image.
Level ?	EnumerationSpan	The level of embossing. Allowed values are from: ▶ EmbossLevel.
Location ?	enumeration	Position of the embossing on the product. Allowed value is : ▶ Face.
Position ?	XYPairSpan	Position of the lower left corner of the bounding box of the embossed image in the coordinate system of the surface of the Component that is selected by @Location.
Separation ? New in JDF 1.6	string	@Separation identifies the separation within the PDL whose color values SHALL be used as the embossing values. A value of 0.0 in the PDL SHALL specify no embossing, a value of 1.0 in the PDL SHALL specify embossing with full depth.
ToolName ? New in JDF 1.6	NMTOKEN	Name of the embossing tool.

7.7 FoldingIntent

This resource specifies the fold intent for a product excluding folds that are implied by binding. See ▶ Section 7.3 BindingIntent for additional details.

Resource Properties

Resource Class: Intent

Process Resource Pairing: [CreasingParams](#), [CuttingParams](#), [Fold](#), [FoldingParams](#), [PerforatingParams](#)

Example Partition: "Option"

Table 7.48: FoldingIntent Resource

NAME	DATA TYPE	DESCRIPTION
FoldingDetails ? New in JDF 1.6	string	@FoldingDetails is a system dependent descriptor of the folding. @FoldingDetails MAY be used to differentiate differing fold dimensions with the same general topology, such as asymmetrical Z-folds.
Folds ? Deprecated in JDF 1.1	XYPair	Number of folds in x and in y direction. This attribute specifies the number of folds seen in the sheet after folding, and not the number of fold operations needed to achieve that result. If not specified, it SHALL be inferred from @FoldingCatalog. If X and Y are the number of folds in the x and y directions, respectively, the product $2*(X+1)*(Y+1)$ SHALL always match the <i>n</i> of "Fn-i" of @FoldingCatalog.
FoldingCatalog	NameSpan	Describes the folding scheme. Note: The folding scheme in this context refers to the folding of the finished product as seen after the cutting, not the folding, of the sheet as seen in production. See LayoutIntent/@Foliocount for a discussion of pagination of folded end products. Values include those from: ▶ Fold Catalog.
Fold * New in JDF 1.1	element	This describes the details of folding operations in the sequence described by the value of @FoldingCatalog. Fold SHALL be specified if non-symmetrical folds are requested.
Orientation ? New in JDF 1.6	EnumerationSpan	@Orientation indicates the orientation of the unfolded product with respect to the lay of the fold. A value of "Rotate0" SHALL be mapped to the lay of the fold on the lower left of the product prior to folding and the front side of the product oriented in the direction of an upward fold. Allowed value is from: ▶ Orientation.

7.8 HoleMakingIntent

This resource specifies the hole making intent for a **JDF** job, using information that identifies the type of hole making operation or alternatively, an explicit list of holes. This resource does not specify whether the media will be pre-drilled or the media will be drilled or punched as part of making the product.

Resource Properties

Resource Class: Intent

Process Resource Pairing: [Hole](#), [HoleLine](#), [HoleMakingParams](#), [Media](#)

Example Partition: "Option"

Table 7.49: HoleMakingIntent Resource (Sheet 1 of 2)

NAME	DATA TYPE	DESCRIPTION
Extent ? New in JDF 1.2	XYPair	Size (bounding box) of the hole in points when specifying a standard hole pattern in HoleType . If not specified the implied default defined in ▶ Appendix K Hole Pattern Catalog is assumed. Ignored when HoleType/@Actual="Explicit" .

Table 7.49: HoleMakingIntent Resource (Sheet 2 of 2)

NAME	DATA TYPE	DESCRIPTION
<i>HoleReferenceEdge</i> = "Left" New in JDF 1.1	enumeration	The edge of the media relative to where the holes are to be punched. Use with <i>HoleType</i> . Allowed values are: Left Right Top Bottom <i>Pattern</i> – Specifies that the reference edge implied by the value of <i>HoleType</i> in <i>Appendix K Hole Pattern Catalog</i> is used.
<i>HoleType</i> Modified in JDF 1.1	StringSpan	Predefined hole pattern. Multiple hole patterns are specified as one NMTO-KENS string (e.g., 3-hole ring binding and 4-hole ring binding holes on one piece of media). Values include: <i>Explicit</i> – Holes are defined in an array of hole elements. <i>2HoleEuro</i> – Replace by either R2m-DIN or R2m-ISO Deprecated in JDF 1.0. <i>3HoleUS</i> – Replace by R3I-US Deprecated in JDF 1.0 <i>4HoleEuro</i> – Replace by R4m-DIN-A4 or R4m-DIN-A5 Deprecated in JDF 1.0. Allowed values are from: <i>Appendix K Hole Pattern Catalog</i> .
<i>HoleList</i> ?	element	Array of all <i>Hole</i> elements. Used only when <i>HoleType</i> / <i>@Actual</i> ="Explicit", otherwise this element is not used.

7.9 InsertingIntent

This resource specifies how to assemble multiple product parts into a final product, using information that identifies page location, position and attachment method. The containing product SHALL be referenced in *InsertingIntent*/*@Container*. The receiving component is defined by a *@ProcessUsage* attribute of "Parent". All other input components are mapped to the *Insert* elements by their ordering in the *ResourceLinkPool*.

Resource Properties

Resource Class: Intent

Process Resource Pairing: *InsertingParams*, *InsertSheet*

Example Partition: "Option"

Table 7.50: InsertingIntent Resource

NAME	DATA TYPE	DESCRIPTION
<i>Folio</i>	IntegerRangeList	List of potential folios where the insert SHALL be placed. A <i>@Folio</i> is defined by its first page in case <i>Method</i> / <i>@Actual</i> ="BlowIn" and by the page that the glue is applied in case <i>Method</i> / <i>@Actual</i> ="BindIn". In general, a list of folios will only be supplied for <i>Method</i> / <i>@Actual</i> ="BlowIn".
<i>GlueType</i> ?	EnumerationSpan	Glue used to fasten the insert. Allowed values are: Permanent Removable
<i>Method</i> ?	EnumerationSpan	Allowed values are: <i>BindIn</i> – Apply glue to fasten the insert. <i>BlowIn</i> – Loose insert.
<i>InsertList</i>	element	List of individual inserts.

7.9.1 InsertList

Table 7.51: InsertList Element

NAME	DATA TYPE	DESCRIPTION
<i>Insert</i> *	element	Individual insert description.

7.9.2 Insert

Table 7.52: Insert Element

NAME	DATA TYPE	DESCRIPTION
<i>Folio</i>	IntegerRangeList	List of potential folios where the insert SHALL be placed. A <i>@Folio</i> is defined by its first page in case <i>Method/@Actual="BlowIn"</i> and by the page that the glue is applied in case <i>Method/@Actual="BindIn"</i> . In general, a list of folios will only be supplied for <i>Method/@Actual="BlowIn"</i> . The pages are counted in the order that is described in <i>@FolioCount</i> of the parent <i>Component/Bundle</i> .
<i>GlueType</i> ?	EnumerationSpan	Glue used to fasten the insert. Default value is from: <i>InsertingIntent/GlueType</i> . Allowed values are: Removable Permanent
<i>Method</i> ?	EnumerationSpan	Inserting method. Default value is from: <i>InsertingIntent/Method</i> . Allowed values are: <i>BindIn</i> – Apply glue to fasten the insert. <i>BlowIn</i> – Loose insert.
<i>SheetOffset</i> ? Deprecated in JDF 1.1	XYPair	Offset between the <i>Component</i> to be inserted and finished page identified by folio in the parent <i>Component</i> . In JDF 1.2 and beyond, the offset is specified in the offset part of <i>@Transformation</i> .
<i>Transformation</i> ?	matrix	Rotation and offset between the <i>Component</i> to be inserted and the parent <i>Component</i> . If not specified, the identity matrix is applied.
<i>WrapPages</i> ? New in JDF 1.1	IntegerRangeList	List of pages of the cover that wrap around a <i>BindItem</i> after all folds are applied. It is sufficient to specify the pages of the "Front" partition of the cover (e.g. cover pages 1 and 4). Note that this attribute SHALL NOT be specified if the position of the cover can be derived from the folding information
<i>GlueLine</i> * New in JDF 1.1	element	Array of all <i>GlueLine</i> elements used to glue in the insert. SHALL NOT be specified in conjunction with <i>@GlueType</i> .

7.10 LaminatingIntent

This resource specifies the laminating intent for a **JDF** job using information that identifies whether or not the product is laminated, and if desired, the temperature and thickness of the laminate.

Resource Properties

Resource Class: Intent

Process Resource Pairing: *LaminatingParams*

Example Partition: "Option"

Table 7.53: LaminatingIntent Resource (Sheet 1 of 2)

NAME	DATA TYPE	DESCRIPTION
<i>Laminated</i> ? Deprecated in JDF 1.1	OptionSpan	If "true", the product is laminated. If no <i>LaminatingIntent</i> is specified, the product SHALL NOT be laminated.
<i>Surface</i> ?	EnumerationSpan	The surface or surfaces to be laminated. Allowed values are: Back Both Front

Table 7.53: LaminatingIntent Resource (Sheet 2 of 2)

NAME	DATA TYPE	DESCRIPTION
Temperature ? Modified in JDF 1.3	EnumerationSpan	Temperature used in the Laminating process. Allowed values are: Hot Cold
Texture ? New in JDF 1.3	NameSpan	The intended texture of the laminate. Values include those from: ▶ Texture.
Thickness ?	NumberSpan	Thickness of the laminating material. Measured in microns [µm].

7.11 LayoutIntent

Modified in JDF 1.2

This resource records the size of the finished pages for the product component. It does not, however, specify the size of any intermediate results such as press sheets. It also describes how the finished pages of the product component SHALL be imaged onto the finished media. The size definition of the finished media describes the size of a sheet that is folded to create a product, not the size of a production sheet (e.g., in the press).

Resource Properties

Resource Class: Intent

Process Resource Pairing: **Assembly**, **BinderySignature**, **Layout**, **LayoutPreparationParams**, **StrippingParams**

Example Partition: "Option"

Table 7.54: LayoutIntent Resource (Sheet 1 of 3)

NAME	DATA TYPE	DESCRIPTION
Bleed ? New in JDF 1.5	NumberSpan	Bleed of the artwork in points. The value of 0 means no bleed. A negative value indicates bleed is needed but the value is unknown.
Dimensions ? New in JDF 1.1	XYPairSpan	Specifies the width (X) and height (Y) in points, respectively, of the trimmed and unfolded (flat) product. For example, Dimensions for a Z-fold is the unfolded dimensions, while FinishedDimensions is the folded dimensions if known. Use Dimensions if FinishedDimensions is not known. The Dimensions span element is provided for the rare case that FinishedDimensions does not unambiguously define the finished product, due to complex folding schemes. If both values are specified, FinishedDimensions takes precedence.
FinishedDimensions ? New in JDF 1.1	ShapeSpan	Specifies the width (X), height (Y) and depth (Z) in points, respectively, of the finished product Component after all finishing operations, including folding, trimming, etc. If the Z coordinate is 0, it is ignored. Only FinishedDimensions SHOULD be specified if both FinishedDimensions and Dimensions are known.
FinishedGrainDirection ? New in JDF 1.2 Deprecated in JDF 1.5	EnumerationSpan	Specifies the media grain direction of the finished page with respect to the binding edge. Allowed values are: ParallelToBind – Grain direction is parallel to the binding edge. PerpendicularToBind – Grain direction is perpendicular to the binding edge. Deprecation note: Use MediaIntent/GrainDirection .
FinishedPageOrientation ? Deprecated in JDF 1.1	enumeration	Indicates the desired orientation of the finished media. Allowed values are: Portrait – The short edges of the media are the top and bottom. Landscape – The long edges of the media are the top and bottom. Note: In JDF 1.1, the finished page orientation is implied by the value of Dimensions and FinishedDimensions . If height (X) > width (Y), the product is portrait.

Table 7.54: LayoutIntent Resource (Sheet 2 of 3)

NAME	DATA TYPE	DESCRIPTION
<p><i>FolioCount</i> = "Booklet" New in JDF 1.1</p>	enumeration	<p>Defines the method used when counting finished pages.</p> <p>Allowed values are:</p> <p>Booklet – Each sample of the component consists of two finished pages (e.g., a leaf—the front side and the back side of one sample of the component). Folds as specified by <i>FoldingIntent</i>/<i>@FoldingCatalog</i> do not affect pagination. Finished pages are counted in reader order of the pages of the component in the product.</p> <p>Flat – The number of finished pages of one sheet of an individual component is given by the product $2*(X+1)*(Y+1)$, where x denotes the number of folds in x direction and y denotes the number of folds in y direction. The pages are counted from the upper left of the front side of the top media to the lower right of the back side of the bottom media. "Flat" SHALL be used for non-standard products where the reader order is ambiguous. The page breaks on a sheet are defined by the folds as specified by <i>FoldingIntent</i>/<i>@FoldingCatalog</i> (see ▶ Appendix A.4.7 Fold Catalog) for the product. All sheets are counted, even if they are not included in the product (e.g., due to a <i>ShapeCuttingIntent</i>).</p>
<p><i>NumberUp</i> = "1 1" Modified in JDF 1.2</p>	XYPair	<p>Specifies a regular, multi-up grid of page cells into which content pages are mapped. The first value specifies the number of columns of page cells and the second value specifies the number of rows of page cells in the multi-up grid (both numbers are integers).</p> <p>At most one of <i>Layout</i> or <i>@NumberUp</i> SHALL be specified.</p>
<p><i>Orientation</i> ? New in JDF 1.6</p>	enumeration	<p><i>@Orientation</i> SHALL specify the orientation of the artwork on the surface as defined by <i>@Sides</i>. <i>@Orientation</i> is used to define products such as back-lit displays, where the orientation of the image with respect to the final product is rotated or mirrored.</p> <p>Allowed value is from: ▶ Orientation.</p>
<p><i>Pages</i> ? New in JDF 1.1 Modified in JDF 1.2</p>	IntegerSpan	<p>Specifies the number of finished pages (surfaces) of the product component, including blank pages. See <i>@SpreadType</i> for a discussion of the scope of <i>@Pages</i>.</p> <p>This value SHALL be an even number. For example, the value for <i>Pages</i> for a two-sided booklet with seven reader pages would be "8", whether the booklet was either saddle stitched or glued.</p>
<p><i>PageVariance</i> ? New in JDF 1.1</p>	IntegerSpan	<p>Specifies the number of non-identical finished pages of the product component (i.e., the number of distinct master pages copied to produce the product). If not specified, the value of pages is used as the default. For example, if there are ten finished pages, in which three are identical, <i>PageVariance</i>/<i>@Actual</i>="8" since it would take eight master copies to produce the product.</p>
<p><i>RotatePolicy</i> ? New in JDF 1.2</p>	enumeration	<p>Specifies the policy to automatically rotate the image to optimize the fit of the image to the page container. For instance, individual landscape pages in a portrait document MAY automatically be rotated. The page container is one cell on the NUp grid of the <i>Media</i> defined in <i>Dimensions</i> or <i>FinishedDimensions</i>.</p> <p>Allowed values are:</p> <p>NoRotate – Do not rotate.</p> <p>RotateOrthogonal – Rotate by 90° in either direction.</p> <p>RotateClockwise – Rotate clockwise by 90°.</p> <p>RotateCounterClockwise – Rotate counter-clockwise by 90°.</p>
<p><i>Sides</i> ? Modified in JDF 1.2</p>	enumeration	<p>Indicates whether contents are to be printed on one or both sides of the media.</p> <p>Allowed value is from: ▶ Sides.</p>

Table 7.54: LayoutIntent Resource (Sheet 3 of 3)

NAME	DATA TYPE	DESCRIPTION
SizePolicy ? New in JDF 1.2	EnumerationSpan	Allows printing even if the container size defined in Dimensions or FinishedDimensions . FinishedDimensions does not match the requirements of the data. The page container is one cell on the NUP grid of the Media defined in Dimensions or FinishedDimensions . Allowed values are: ClipToMaxPage – The page contents SHALL be clipped to the size of the container. The printed area is centered in the source image. FitToPage – The page contents SHALL be scaled up or down to fit the container. The aspect ratio is maintained. ReduceToFit – The page contents SHALL be scaled down but not scaled up to fit the container. The aspect ratio is maintained. Tile – The page contents SHALL be split into several tiles, each printed on its own container.
SpreadType ? New in JDF 1.6	enumeration	@SpreadType SHALL specify the treatment of individual PDF pages referenced by the DPart node for which @SpreadType is specified for imposition purposes. Allowed values are: SinglePage – The content of each page SHALL be imaged in a single cell in imposition. Each finished page SHALL be counted as an individual page. For instance, a booklet cover would have four pages. Spread – The content of each page SHALL be imaged as a single surface onto the final product. Examples include wraparound covers. Spread SHOULD NOT be provided for adjacent pages that are not imaged onto the same surface. Each surface of the spread SHALL be counted as an individual page. For instance, a wrap around cover would have two pages. Note: Products with finished pages of varying size such as wrap around covers with a spine or fold outs in a booklet will typically be defined as spreads. Note: Content will typically be provided as single pages.
Layout ? New in JDF 1.1	refelement	Specifies the details of a more complex Layout . At most one of Layout or @NumberUp SHALL be specified. Note that the Layout specified in LayoutIntent specifies the layout definition of the finished product and not the layout of the production sheets.

7.12 MediaIntent

Modified in JDF 1.2

This resource describes the media to be used for the product component. In some cases, the exact identity of the medium is known, while in other cases, the characteristics are described and a particular stock is matched to those characteristics.

Resource Properties

Resource Class: Intent

Process Resource Pairing: [Media](#)

Example Partition: "Option"

Table 7.55: MediaIntent Resource (Sheet 1 of 5)

NAME	DATA TYPE	DESCRIPTION
BackCoatings ?	EnumerationSpan	Identical to FrontCoatings , but applied to the back surface of the media. Default value is from: @FrontCoatings . Allowed values are from: ▶ Coating.
Brightness ?	NumberSpan	Reflectance percentage of diffuse blue reflectance as defined by ▶ [ISO2470-1:2016]. The reflectance is reported per ▶ [ISO2470-1:2016] as the diffuse blue reflectance factor of the paper or board in percent to the nearest 0.5% reflectance factor.
BuyerSupplied ?	OptionSpan	Indicates whether the customer will supply the media. Note: The Media resource can be used to specify additional media requirements, particularly when the media is supplied by the customer.

Table 7.55: MediaIntent Resource (Sheet 2 of 5)

NAME	DATA TYPE	DESCRIPTION
Dimensions ? Deprecated in JDF 1.2	XYPairSpan	Specifies the size of the supplied media in points if BuyerSupplied evaluates to "true". Dimensions SHALL be ignored if BuyerSupplied evaluates to "false". Note that the size of the finished product is always specified in LayoutIntent/FinishedDimensions . In JDF 1.2 and beyond the specifics of BuyerSupplied media SHOULD be specified using a Media resource. The dimensions of the finished product are specified with LayoutIntent/Dimensions or LayoutIntent/FinishedDimensions .
Flute ? New in JDF 1.4	NameSpan	Single, capital letter that specifies the flute type of corrugated media. Values include those from: ▶ Flute Types.
FluteDirection ? New in JDF 1.4	EnumerationSpan	Direction of the flute of corrugated media in the coordinate system of the product. Allowed values are from: ▶ MediaDirection.
FrontCoatings ? Modified in JDF 1.2	EnumerationSpan	What pre-process coating has been applied to the front surface of the media. Allowed values are from: ▶ Coating.
Grade ? Modified in JDF 1.5 Deprecated in JDF 1.6	IntegerSpan	The intended grade of the media on a scale of 1 through 5. Grade is ignored if MediaType/@Actual is not "Paper". Grade of paper material is defined in accordance with the paper "types" set forth in ▶ [ISO12647-2:2004]. Offset printing paper types are defined with integer values. If a workflow supports @ISOPaperSubstrate , and both @Grade and @ISOPaperSubstrate are present, it SHALL use @ISOPaperSubstrate . Note: ▶ [ISO12647-2:2004] paper grade @Grade values do not align with U.S. GRACOL paper grade @Grade values (e.g., ▶ [ISO12647-2:2004] type 1 does not equal U.S. GRACOL grade 1). Values include: 1 – Gloss-coated paper. 2 – Matt-coated paper. 3 – Gloss-coated, web paper. 4 – Uncoated, white paper. 5 – Uncoated, yellowish paper. Modification note: Starting with JDF 1.5 , condition for new @ISOPaperSubstrate added.
GrainDirection ? New in JDF 1.2 Modified in JDF 1.5	EnumerationSpan	Direction of the grain in the coordinate system defined by LayoutIntent/Dimensions or LayoutIntent/FinishedDimensions . Allowed values are from: ▶ MediaDirection.
HoleCount ? Deprecated in JDF 1.1	IntegerSpan	The intended number of holes that are to be punched in the media (either pre- or post-punched). Starting with JDF 1.1 , use HoleType which includes the number of holes.
HoleType ? New in JDF 1.1	StringSpan	Predefined hole pattern that specifies the pre-punched holes in the media. Multiple hole patterns are specified as one NMTOKENS string (e.g., 3-hole ring binding and 4-hole ring binding holes on one piece of media). Values include: None – no holes Values include those from: ▶ Appendix K Hole Pattern Catalog.
ISOPaperSubstrate ? New in JDF 1.5	EnumerationSpan	@ISOPaperSubstrate supersedes @Grade and adds new values to allow for improved papers. If a workflow supports @ISOPaperSubstrate , and both @Grade and @ISOPaperSubstrate are present, it SHALL use @ISOPaperSubstrate . @ISOPaperSubstrate SHALL specify the type of paper material defined in accordance with the print substrate set forth in ▶ [ISO12647-2:2013]. Allowed value is from: ▶ ISOPaperSubstrate. Note: See ▶ Section E.3 Paper Grade for a mapping to the paper grade values defined in ISO12647-2:2004

Table 7.55: MediaIntent Resource (Sheet 3 of 5)

NAME	DATA TYPE	DESCRIPTION
MediaColor ?	EnumerationSpan	Color of the media. If more-specific, specialized or site-specific media color names are needed, use MediaColorDetails . Allowed values are from: ▶ NamedColor.
MediaColorDetails ? New in JDF 1.2	StringSpan	A more specific, specialized or site-defined name for the media color. If MediaColorDetails is supplied, MediaColor SHOULD also be supplied. Note: There is a one-to-many relationship between entries in MediaColor and MediaColorDetails (e.g., MediaColorDetails values of "Burgundy" and "Ruby" both correspond to a MediaColor of "DarkRed").
MediaQuality ? New in JDF 1.4	StringSpan	Named quality description of the media. For folding carton quality, multiple named quality description systems are in use (e.g., GC1, SBB, etc.). For an overview, see ▶ [Pro Carton Fact File]. When used in a general product description, Media with the same @MediaQuality are identical from the customer point of view. Thus characteristics such as weight, coatings or recycling percentage are identical whereas lot or sheet dimension may vary based on production or warehousing requirements.
MediaSetCount ?	integer	When the input media is grouped in sets, identifies the number of pieces of media in each set. For example, if the @UserMediaType is "PreCutTabs", a @MediaSetCount of 5 would indicate that each set includes 5 tab sheets.
MediaType ? New in JDF 1.1 Modified in JDF 1.5	NameSpan	Describes the medium being employed. Allowed values are: CorrugatedBoard New in JDF 1.3 Disc – CD or DVD disc to be printed on. New in JDF 1.2 Other – Any other media. For this value MediaTypeDetails SHOULD also be specified Paper SelfAdhesive New in JDF 1.3 Textile New in JDF 1.5 Transparency Vinyl New in JDF 1.5
MediaTypeDetails ? New in JDF 1.3	NameSpan	Describes additional details of the medium described in MediaType . Values include those from: ▶ MediaType Details. Note: Values from ▶ MediaType Details are RECOMMENDED. However, some process related values, such as "DryFilm", SHOULD NOT be used for this attribute.
MediaUnit ? Deprecated in JDF 1.2	EnumerationSpan	Describes the format of the media as it is delivered to the device. Allowed values are: Roll Sheet Deprecation note: Deprecated because intent attributes and span elements pertain to finished product, not the raw media format. If BuyerSupplied ="true", then the Media resource can be used to provide this span element.
Opacity ? Modified in JDF 1.2	EnumerationSpan	The opacity of the media. See OpacityLevel to specify the degree of opacity for any of these values. Allowed values are from: ▶ Opacity.
OpacityLevel ? New in JDF 1.2	NumberSpan	Normalized TAPPI opacity, (Cn), as defined and computed in ▶ [ISO2471:2008]. Refer also to ▶ [TAPPI T519] for calculation examples.
PrePrinted = "false"	boolean	Indicates whether the media is preprinted.
Recycled ? Deprecated in JDF 1.2	OptionSpan	If "true", recycled media is requested. In JDF 1.2 and beyond, use RecycledPercentage .

Table 7.55: MediaIntent Resource (Sheet 4 of 5)

NAME	DATA TYPE	DESCRIPTION
RecycledPercentage ? New in JDF 1.2	NumberSpan	The percentage, between 0 and 100, of recycled material that the media is expected to contain.
StockBrand ?	StringSpan	Strings providing available brand names. The customer might know exactly what paper is to be used. Example is “Lustro” or “Warren Lustro” even though the manufacturer name is included.
StockType ?	NameSpan	Strings describing the available stock. @StockType defines the base size when calculating North American or Japanese paper weights. See ▶ Appendix E Media Weight for details including predefined values. Values include those from: Media / @StockType
Texture ?	NameSpan	The intended texture of the media. Values include those from: ▶ Texture.
Thickness ? New in JDF 1.1	NumberSpan	The thickness of the chosen medium. Measured in microns [µm].
UserMediaType ? Deprecated in JDF 1.6	NMTOKEN	A human-readable description of the type of media. The value can be used by an operator to select the correct media to load. The semantics of the values will be site-specific. Values include: Continuous – Continuously connected sheets of an opaque material. Which edge is connected is not specified. ContinuousLong – Continuously connected sheets of an opaque material connected along the long edge. ContinuousShort – Continuously connected sheets of an opaque material connected along the short edge. Envelope – Envelopes that can be used for conventional mailing purposes. EnvelopePlain – Envelopes that are not preprinted and have no windows. EnvelopeWindow – Envelopes that have windows for addressing purposes. FullCutTabs – Media with a tab that runs the full length of the medium so that only one tab is visible extending out beyond the edge of non-tabbed media. Labels – Label stock (e.g., a sheet of peel-off labels). Letterhead – Separately cut sheets of an opaque material including a letter-head. MultiLayer – Form medium composed of multiple layers which are preattached to one another (e.g., for use with impact printers). MultiPartForm – Form medium composed of multiple layers not preattached to one another; each sheet MAY be drawn separately from an input source. Photographic – Separately cut sheets of an opaque material to produce photographic quality images. PreCutTabs – Media with tabs that are cut so that more than one tab is visible extending out beyond the edge of non-tabbed media. Stationery – Separately cut sheets of an opaque material. TabStock – Media with tabs (either precut or full-cut). Transparency – Separately cut sheets of a transparent material. Deprecation note: Starting with JDF 1.6, use @MediaTypeDetails .
USWeight ? Deprecated in JDF 1.2	NumberSpan	The intended weight of the media, measured in pounds per ream of basis size. At most one of Weight or USWeight SHALL be specified. If known, Weight SHOULD be specified in grammage (g/m ²). In JDF 1.2 and beyond, use Weight .
Weight ?	NumberSpan	The intended weight of the media, measured in grammage (g/m ²) of the media. See ▶ Appendix E Media Weight for an explanation of how to calculate the US weight from the grammage for different stock types.
Certification * New in JDF 1.6	element	Each Certification specifies a minimum requested paper certification level.

Table 7.55: MediaIntent Resource (Sheet 5 of 5)

NAME	DATA TYPE	DESCRIPTION
MediaLayers ? New in JDF 1.4	element	Subelement describing the layer structure of media such as corrugated or self adhesive materials.

7.13 NumberingIntent

Deprecated in JDF 1.5

7.14 PackingIntent

This resource specifies the packaging intent for a **JDF** job, using information that identifies the type of package, the wrapping used, and the shape of the package. Note that this specifies packing for shipping only, not packing of items into custom boxes, etc. Boxes are convenience packaging and are not envisioned to be protection for shipping. Cartons perform this function. All quantities are specified as finished pieces per wrapped/boxed/carton or palletized package. The model for packaging is that products are wrapped together, wrapped packages are placed in *boxes*, boxes are placed in *cartons*, and cartons are stacked on *pallets*.

Resource Properties

Resource Class: Intent

Process Resource Pairing: [BoxPackingParams](#), [Bundle](#), [Component](#), [PalletizingParams](#), [Pallet](#), [ShrinkingParams](#), [StackingParams](#), [Strap](#), [StrappingParams](#), [WrappingParams](#)

Example Partition: "Option"

Table 7.56: PackingIntent Resource (Sheet 1 of 2)

NAME	DATA TYPE	DESCRIPTION
BoxedQuantity ?	IntegerSpan	How many units of <i>product</i> in a box.
BoxShape ?	ShapeSpan	Describes the length, width and height of the box, in points.
CartonMaxWeight ?	NumberSpan	Maximum gross weight of an individual carton, in kilograms.
CartonQuantity ?	IntegerSpan	How many units of <i>product</i> in a carton.
CartonShape ?	ShapeSpan	Describes the length, width and height of the carton, in points. For example, 288 544 1012
CartonStrength ?	NumberSpan	Strength of the carton, in kilograms.
FoldingCatalog ?	NameSpan	Describes the folding scheme for folding the product for packaging. Note: The folding scheme in this context refers to the folding of the finished product for packaging only. The folding has no effect on the page/Folio definition. Values include those from: ▶ Fold Catalog.
PalletCornerBoards ? New in JDF 1.3	NameSpan	Additional protective corner boards for packaging on a pallet: Values include: Corners – Corner boards on 8 corners of the pallet. VerticalEdge – Corner boards along the 4 vertical edges.
PalletMaxHeight ?	NumberSpan	Maximum height of a loaded pallet, in points.
PalletMaxWeight ?	NumberSpan	Maximum weight of a loaded pallet, in kilograms.
PalletQuantity ?	IntegerSpan	Number of <i>product</i> per pallet
PalletSize ?	XYPairSpan	Describes the length and width of the pallet, in points (e.g., "3500 3500").
PalletType ?	NameSpan	Type of pallet used. Values include those from: ▶ Pallet Types.

Table 7.56: PackingIntent Resource (Sheet 2 of 2)

NAME	DATA TYPE	DESCRIPTION
PalletWrapping ?	NameSpan	Wrapping of the completed pallet. Values include: Banding None – explicitly requests no wrapping. StretchWrap
WrappedQuantity ?	IntegerSpan	Number of units of product per wrapped package.
WrappingMaterial ?	NameSpan	Values include: None – explicitly requests no wrapping. PaperBand Polyethylene RubberBand ShrinkWrap

7.15 ProductionIntent

This resource specifies the manufacturing intent and considerations for a **JDF** job using information that identifies the desired result or specified manufacturing path. If specific details of print quality, such as color quality, need to be specified, [@ProductionResources](#) SHOULD reference a [QualityControlParams](#) resource.

Resource Properties

Resource Class: Intent
 Example Partition: "Option"

Table 7.57: ProductionIntent Resource

NAME	DATA TYPE	DESCRIPTION
PrintPreference ?	EnumerationSpan	Intended result or goal. Allowed values are: Balanced – Request for a manufacturing process that balances the requirements for cost, speed and quality. CostEffective – Request for the most cost effective manufacturing process. Fastest – Request for the most time effective manufacturing process. Cost and quality can be sacrificed for a fast turnaround time. HighestQuality – Request for the manufacturing process that will result in the highest quality.
PrintProcess ? Modified in JDF 1.3	NameSpan	Print process requested. Values include those from: ▶ Printing Technologies . Modification Note: Starting with JDF 1.3 , the data type of PrintProcess is expanded from EnumerationSpan to NameSpan .
Resource * New in JDF 1.3	refelement	Any production resources that are provided by the customer. Some examples include buyer specified media, ink or specific parameter setups. Note that DeliveryIntent SHALL be specified for any PhysicalResource elements that are physically supplied by the customer.

7.16 ProofingIntent

This resource product intent element specifies the prepress proofing intent for a **JDF** job using information that identifies the type, quality, brand name and overlay of the proof. The proofs defined in [ProofingIntent](#) define the proofs that will be provided to the customer and does not specify internal production proofs. The delivery options of proofs MAY be specified in [DeliveryIntent](#).

Resource Properties

Resource Class: Intent
 Process Resource Pairing: [ApprovalParams](#), [ApprovalSuccess](#), [ColorantControl](#), [ColorSpaceConversionParams](#), [ExposedMedia](#), [ImageSetterParams](#), [InterpretingParams](#), [Layout](#), [Media](#), [RenderingParams](#), [ScreeningParams](#), [SeparationControlParams](#), [StrippingParams](#)

Example Partition: "Option"

Table 7.58: ProofingIntent Resource

NAME	DATA TYPE	DESCRIPTION
PreflightItem * New in JDF 1.6	element	PreflightItem defines the preflight rules for a range of pages.
ProofItem * New in JDF 1.1	element	Specifies the details of the proofs that are needed. If no ProofItem exists in a ProofingIntent , it explicitly specifies that no proofs are desired.

7.16.1 PreflightItem

New in JDF 1.6

Table 7.59: PreflightItem Element

NAME	DATA TYPE	DESCRIPTION
PreflightLevel ?	enumeration	Level of content data checking / preflighting. The details are implementation specific. Allowed values are: Basic – Check only for severe errors. Examples include missing fonts, unknown file format, incorrect page size, missing passwords. Extended – Check for additional errors that can degrade output quality and can be resolved by the customer. Examples include: low image resolution, unknown color space details. Premium – Highest available check for additional errors. This level MAY include manual repairs by the printer

7.16.2 ProofItem

All parameters of **ProofingIntent** have been moved into **ProofItem** in JDF 1.1

Table 7.60: ProofItem Element (Sheet 1 of 2)

NAME	DATA TYPE	DESCRIPTION
Amount ? Modified in JDF 1.1	IntegerSpan	Specifies the total number of copies of this proof that is needed. If not specified, it defaults to an IntegerSpan with @Preferred="1" .
BrandName ? Modified in JDF 1.1	StringSpan	Brand name of the proof (e.g., Iris).
ColorType ? Modified in JDF 1.1	EnumerationSpan	Color quality of the proof. Allowed values are: Monochrome – Generic single color printing condition (e.g., black and white or one single spot color). BasicColor – Color does not match precisely. This implies the absence of a color matching system. MatchedColor – Color is matched to the output of the press using a color matching system.
Contract="false" Modified in JDF 1.1	boolean	Requires proof to be a legally binding, accurate representation of the image to be printed (i.e., color quality requirements have been met when the printed piece acceptably matches the proof).
HalfTone ? Modified in JDF 1.1	OptionSpan	Specifies whether the proof SHALL emulate halftone screens.

Table 7.60: ProofItem Element (Sheet 2 of 2)

NAME	DATA TYPE	DESCRIPTION
ImageStrategy ? New in JDF 1.2	EnumerationSpan	Identifies which images (OPI or other) will be printed on a proof or displayed as a soft proof. Allowed values are: NoImages – No images are imaged on the proof. LowResolution – Low resolution images are imaged on the proof. HighResolution – High resolution production images are imaged on the proof, resulting in proofs that accurately represent the final product.
PageIndex ? New in JDF 1.1	IntegerRangeList	Index list of pages that are to be proofed in the ArtDeliveryIntent/RunList/PageList . If no range is specified then all pages SHALL be proofed.
ProofName ? New in JDF 1.1	string	Name of the ProofItem . This field SHALL be specified if delivery of a proof is specified in DeliveryIntent DeliveryParams .
ProofTarget ? Modified in JDF 1.1	URL	Identifies a remote target for the proof output in a remote proofing environment. This can be either a soft or a hard proofing target. The file to be displayed or output SHALL be sent to the URL specified in @ProofTarget .
ProofType ? Modified in JDF 1.1	EnumerationSpan	The kind of proof. Allowed values are: Page – Page proof Imposition – Imposition proof None – No proof is needed.
Technology ? Modified in JDF 1.1	NameSpan	Technology used for making the proof. Values include: BlueLine DyeSub InkJet Laser PressProof SoftProof
ApprovalParams ? New in JDF 1.2	refelement	List of people (e.g., a customer, printer or manager) who can sign the ApprovalSuccess .
SeparationSpec * New in JDF 1.1	element	Separations that are to be proofed. If not specified, all separations SHALL be proofed.

7.17 PublishingIntent

New in JDF 1.3

[PublishingIntent](#) specifies publishing metadata that are of general interest for prepress, press and postpress. The data include details on the general structure of product being published.

Resource Properties

Resource Class: Intent

Process Resource Pairing: —

Example Partition: "Edition"

Table 7.61: PublishingIntent Resource (Sheet 1 of 2)

NAME	DATA TYPE	DESCRIPTION
Circulation ?	IntegerSpan	Specifies the number of copies to be published.
ContentDataRefs ? New in JDF 1.4	IDREFS	IDs of ContentData elements in the referenced ContentList . ContentData elements provide metadata related to the product to be published. @ContentDataRefs SHALL NOT be specified if no ContentList is specified.
IssueDate	TimeSpan	Publication date of the issue.
IssueName	StringSpan	The name of a the publication.

Table 7.61: PublishingIntent Resource (Sheet 2 of 2)

NAME	DATA TYPE	DESCRIPTION
IssueType Modified in JDF 1.4	NameSpan	Defines the product type of the issue. Values include: Magazine – The publication is a magazine Newspaper – The publication is a newspaper Supplement – The publication is a supplement to a magazine or newspaper. New in JDF 1.4.
ContentList ? New in JDF 1.4	refelement	ContentList with additional metadata.

7.18 ScreeningIntent

New in JDF 1.2

This Resource specifies the screening intent parameters desired for a **JDF** job.

Resource Properties

Resource Class: Intent

Process Resource Pairing: **ScreeningParams**, **SeparationControlParams**

Example Partition: "Option"

Table 7.62: ScreeningIntent Resource

NAME	DATA TYPE	DESCRIPTION
DotSize ?	NumberSpan	Specifies the dot size of the screen in microns [μm] when FM screening is used, otherwise DotSize is ignored.
Frequency ?	NumberSpan	Specifies the line frequency of the screen in lines per inch (lpi) when AM screening is used, otherwise Frequency is ignored.
FrequencySelection ?	EnumerationSpan	Selects the AM or FM frequency range. Allowed values are: LowestFrequency – Lowest AM or FM frequency supported. MiddleFrequency – Middle AM or FM frequency supported HighestFrequency – Highest AM or FM frequency supported
ScreeningType ?	EnumerationSpan	General type of screening. Allowed values are: AM – Can be line or dot. FM

7.19 ShapeCuttingIntent

ShapeCuttingIntent describes finishing of products with irregular shapes, including die cutting and adding windows to envelopes.

Resource Properties

Resource Class: Intent

Process Resource Pairing: **CuttingParams**, **ShapeCuttingParams**

Example Partition: "Option"

Table 7.63: ShapeCuttingIntent Resource

NAME	DATA TYPE	DESCRIPTION
ShapeCut *	element	Array of all ShapeCut elements. Used when each shape is exactly specified.

7.19.1 ShapeCut

Table 7.64: ShapeCut Element

NAME	DATA TYPE	DESCRIPTION
CutBox ?	rectangle	Specification of a rectangular window. An orthogonal line MAY be defined by specifying a rectangle with identical dimensions.
CutDepth ? New in JDF 1.6	EnumerationSpan	Allowed values are: Full – The form is completely cut out or perforated. Partial – The form is not completely cut out or perforated. The exact depth MAY be specified in ShapeCuttingParams .
CutOut = "false"	boolean	@CutOut specifies whether the inside or outside of the ShapeCut SHALL be removed. If @CutOut ="true", the inside of a specified shape SHALL be removed, otherwise the outside of a specified shape SHALL be removed. An example of an inside shape is a window, while an example of an outside shape is a shaped greeting card.
CutPath ? Modified in JDF 1.2	PDFPath	Specification of a complex path. This MAY be an open path in the case of a single line.
CutType ? Modified in JDF 1.1	EnumerationSpan	Type of cut or perforation used. Allowed values are: Cut – Full cut. Perforate – Interrupted perforation that does not span the entire sheet.
Material ?	StringSpan	Transparent material that fills a shape (e.g., an envelope window) that was cut out when @CutOut ="true".
Pages ?	IntegerRangeList	List of finished pages to which this shape SHALL be applied. Only the recto finished page of a leaf SHOULD be specified.
ShapeDepth ? New in JDF 1.1 Deprecated in 1.6	NumberSpan	Depth of the shape cut. Measured in microns [µm]. If not specified, the shape is completely cut. Deprecation Note: From version 1.6 use @CutDepth instead.
ShapeType Modified in JDF 1.3	EnumerationSpan	Describes any precision cutting other than hole making. Allowed values are: Line – The coordinates specified in @CutBox specify the end points of a straight line. Path – Any irregular shape. Additional details SHOULD be provided in @CutPath or @ShapeTypeDetails . Rectangular – The coordinates specified in @CutBox specify the lower left and upper right coordinates of a rectangle. Round - Circular or elliptical shape depending on the aspect ratio of @CutBox . RoundedRectangle – Rectangle with rounded corners. The coordinates specified in @CutBox specify the outer bounds of the rectangle. New in JDF 1.3
ShapeTypeDetails ? New in JDF 1.6	string	A more specific, specialized or site-defined name for the shape of the ShapeCut .
TeethPerDimension ?	NumberSpan	Number of teeth in a given perforation extent in teeth/point. Micro perforation is defined by specifying a large number of teeth (n > 1000).

7.20 SizeIntent

Deprecated in JDF 1.1

SizeIntent has been deprecated in **JDF** 1.1. All contents have been moved to [LayoutIntent](#).

7.21 VariableIntent

New in JDF 1.6

[VariableIntent](#) specifies the variations of the content for printed data with variable content such as lottery tickets or direct mail.

If the product that links to **VariableIntent** has sub-products, then the **ComponentLink/@Amount** of the referenced sub-products SHALL specify the estimated amounts of the respective products. **VariableIntent** SHALL NOT be specified if **InsertingIntent** or **BindingIntent** are specified.

Resource Properties

Process Resource Pairing: **DigitalPrintingParams**, **LayoutElementProductionParams**

Table 7.65: VariableIntent Element

NAME	DATA TYPE	DESCRIPTION
Area ?	NumberSpan	Ratio of the document that can contain variable content. A value of 0 specifies a non variable document. A value of 1 specifies a full variable document.
AveragePages ?	IntegerSpan	AveragePages SHALL specify the average number of printed pages in each record.
MaxPages ?	IntegerSpan	@MaxPages SHALL specify the maximum number of printed pages in each record. @MaxPages SHALL NOT be smaller than @AveragePages .
MinPages ?	IntegerSpan	@MinPages SHALL specify the minimum number of printed pages in each record. @MinPages SHALL NOT be larger than @AveragePages .
NumberOfCopies ?	IntegerSpan	Average number of copies of each record. This value SHALL equal "1" for fully variable data.
VariableType ?	EnumerationSpan	Type of variable content. Allowed Values are (in order of rising complexity): OneLine - A single line of text data is variable. OneLine includes simple numbering applications. AddressField - Multiple lines of text data are variable. IdentificationField - The variable data includes a Barcode or QR-Code. Area - The area as defined in @Area is fully variable.
VariableQuality ?	EnumerationSpan	VariableQuality specifies the desired quality of the variable data. Allowed Values are: Simple - The variable text MAY be recognized as printed by a different technology such as dot matrix or simple inkjet overprints. Imprint - The variable data SHOULD be similar to the non-variable part but MAY be imprinted. Full - All data SHOULD be printed with the same technology.
ColorsUsed ?	element	Array of colorant separation names that are required to print the variable part of the documents. The values that are specified in ColorsUsed SHALL also be specified in ColorIntent/ColorsUsed . See ColorIntent/ColorsUsed for additional details

8 Resources

This chapter provides a list (in alphabetical order) of all specific resource types.

8.1 AdhesiveBindingParams

Deprecated in JDF 1.1

8.2 ApprovalParams

ApprovalParams provides the details of an **Approval** process.

Resource Properties

Resource Class: **Parameter**

Resource referenced by: **ProofItem, ConventionalPrintingParams, DigitalPrintingParams**

Intent Pairing: **ProofingIntent**

Input of Processes: **Approval**

Table 8.1: ApprovalParams Resource

NAME	DATA TYPE	DESCRIPTION
<i>MinApprovals</i> = "1" New in JDF 1.2	integer	Minimum number of ApprovalPerson [@ApprovalRole="Group"] whose associated person SHALL sign the ApprovalSuccess for the ApprovalSuccess to be "Available".
ApprovalPerson *	element	List of people (e.g., a customer, printer or manager) who can sign the approval.

8.2.1 ApprovalPerson

ApprovalPerson specifies the details of person who is responsible for signing an approval.

Table 8.2: ApprovalPerson Element

NAME	DATA TYPE	DESCRIPTION
<i>ApprovalRole</i> = "Obligated" New in JDF 1.2 Modified in JDF 1.3	enumeration	Role of the ApprovalPerson . Allowed values are: Approvator – The decision of this approver immediately overrides the decisions of the other approvers and ends the approval cycle. The "Approvator" NEED NOT sign for the approval to become valid. New in JDF 1.3 Group – The approver belongs to a group of which @MinApprovals members SHALL sign. Informative – The approver is informed of the Approval process, but the approval is still valid, even without his approval. Obligated – The approver SHALL sign the approval.
<i>ApprovalRoleDetails</i> ? New in JDF 1.3	string	Additional details on the @ApprovalRole.
<i>Obligated</i> ? Deprecated in JDF 1.2	boolean	If "true", the person has to sign this approval. In JDF 1.2 and beyond, use @ApprovalRole.
Contact	refelement	Contact (e.g., a customer, printer or manager) who SHALL sign the approval. There SHALL be a Contact [contains (@ContactTypes, "Approver")].

8.3 ApprovalSuccess

The signed [ApprovalSuccess](#) resource provides the signature that indicates that a resource has been approved or rejected. This is frequently used to model the success of a soft proof, color proof, printing proof or any other sort of proof.

Resource Properties

Resource Class: Parameter

Example Partition: "DocIndex", "DocRunIndex", "RunIndex", "RunPage", "RunTags", "DocTags", "PageTags", "SetTags", "SetIndex", "SheetName", "Side", "SignatureName", "TileID"

Input of Processes: Any Process

Output of Processes: Approval, Verification

Table 8.3: ApprovalSuccess Resource

NAME	DATA TYPE	DESCRIPTION
ApprovalDetails * New in JDF 1.3	element	Container for details about the decision for each approver.
Contact * New in JDF 1.2 Deprecated in JDF 1.3	refelement	List of contacts that have signed off on this approval. Use ApprovalDetails/Contact in JDF 1.3 and above.
FileSpec ? Deprecated in JDF 1.3	refelement	The file that contains the approval signature. If FileSpec does not exist, ApprovalSuccess is a logical placeholder. Use ApprovalDetails/FileSpec in JDF 1.3 and above.

8.3.1 ApprovalDetails

New in JDF 1.3

Table 8.4: ApprovalDetails Element

NAME	DATA TYPE	DESCRIPTION
ApprovalState	enumeration	Decision made by the approver specified in this ApprovalDetails/Contact . Allowed values are: Approved – approver approved the resource. ApprovedWithComment – approver approved the resource but still had some comments. Rejected – approver rejected the resource.
ApprovalStateDetails ?	string	Additional details on the decision made by the approver are specified in this ApprovalDetails/Contact . This value provides additional machine readable details of @ApprovalState . Hand written comments and notes MAY be specified in ApprovalDetails/Comment or ApprovalDetails/@CommentURL .
Contact ?	refelement	Contact that signed off on this approval.
FileSpec ?	refelement	The file that contains the approval signature. If FileSpec does not exist, ApprovalSuccess is a logical placeholder.

8.4 Assembly

New in JDF 1.2

[Assembly](#) describes how the sections of one or multiple jobs or job parts are bound together.

Resource Properties

Resource Class: Parameter

Intent Pairing: [LayoutIntent](#)

Input of Processes: **Collecting, Gathering, SheetOptimizing, Stripping, WebInlineFinishing**

Table 8.5: Assembly Resource

NAME	DATA TYPE	DESCRIPTION
<i>AssemblyID</i> ? Deprecated in JDF 1.3	string	Identification of the Assembly if Stripping produces multiple Assembly elements.
<i>AssemblyIDs</i> ? New in JDF 1.3	NMTOKENS	Identification of the Assembly elements if Stripping describes an imposition scheme for multiple Assembly elements. <i>@AssemblyIDs</i> MAY contain multiple NMTOKENS, when the Assembly resource specifies an intermediate product that contains multiple final assemblies.
<i>BindingSide</i> ="Left"	enumeration	Indicates which side SHALL be bound. <i>@BindingSide</i> is ignored when <i>@Order</i> ="None". Allowed value is from: ▶ Edge.
<i>JobID</i> ?	string	Identification of the original job the Assembly belongs to. If not specified, it defaults to the value specified or implied in the JDF node.
<i>JogSide</i> = "Top" New in JDF 1.3	enumeration	<i>@JogSide</i> specifies the side on which the AssemblySection elements will be aligned. Allowed values are: Left Right Top Bottom None
<i>Order</i> ="Gathering"	enumeration	Ordering of the individual AssemblySection s. Order specifies the topology of the final Assembly . Allowed values are: Collecting – The sections are placed within one another. The first section is on the outside. An example is a saddle-stitched brochure. See ▶ Section 6.5.10 Collecting. Gathering – The sections are placed on top of one another. The first section is on the top. An example is a perfect bound magazine. See ▶ Section 6.5.20 Gathering. List – More complex ordering of the sections. If multiple child AssemblySection elements are provided, these are gathered on top of one another. The first AssemblySection is on the top. If nested AssemblySection elements are provided, these are collected into each other. The first AssemblySection is on the outside. None – The sections are not bound. Typically used for flatwork jobs.
<i>PhysicalSection</i> ? New in JDF 1.3	IntegerList	Specifies the physical structure of a newspaper. The structure is based on a broadsheet production. For instance, <i>@PhysicalSection</i> ="8 6 8 6" represents a 4 book production with 8 pages in the first physical section, 6 in the second one and so on.
AssemblySection *	element	Individual AssemblySection elements which are gathered. AssemblySection elements SHALL NOT be specified unless <i>@Order</i> ="List".
<i>PageAssignedList</i> * New in JDF 1.3	element	Defines the page sequence for an Assembly . One <i>PageAssignedList</i> element corresponds to one or more consecutive reader pages. The order of the <i>PageAssignedList</i> elements specifies the reader order of the assigned pages within the Assembly . <i>PageAssignedList</i> SHALL NOT be specified if <i>@Order</i> ="List".
<i>PageList</i> ? New in JDF 1.3	refelement	Reference to the <i>PageList</i> that describes the pages used in this Assembly .

8.4.1 AssemblySection

Table 8.6: AssemblySection Element

NAME	DATA TYPE	DESCRIPTION
<i>AssemblyID</i> ? Deprecated in JDF 1.3	string	Identification of the <i>AssemblySection</i> if Stripping produces a multi-section <i>Assembly</i> . If not specified, it defaults to the value specified or implied in the parent <i>Assembly</i> or <i>AssemblySection</i> .
<i>AssemblyIDs</i> ? New in JDF 1.3	NMTOKENS	Identification of the <i>AssemblySection</i> elements if Stripping describes an imposition scheme for a multi-section <i>Assembly</i> . If not specified, it defaults to the value specified or implied in the parent <i>Assembly</i> or <i>AssemblySection</i> . In general <i>AssemblySection/@AssemblyIDs</i> will contain only a single NMTOKEN value. <i>@AssemblyIDs</i> MAY contain multiple NMTOKENS, when the <i>AssemblySection</i> specifies an intermediate product that contains multiple final products.
<i>JobID</i> ?	string	Identification of the original job the <i>AssemblySection</i> belongs to. If not specified, it defaults to the value specified or implied in the parent <i>Assembly</i> or <i>AssemblySection</i> .
<i>Order="Gathering"</i> Deprecated in JDF 1.4	enumeration	Ordering of the child <i>AssemblySection</i> elements. Allowed values are: Collecting – The child <i>AssemblySection</i> elements are placed within one another. The first section is on the outside. Gathering – The child <i>AssemblySection</i> elements are placed on top of one another. The first section is on the top. Deprecation note: Starting with JDF 1.4, Sibling <i>AssemblySection</i> elements are gathered whereas child <i>AssemblySection</i> elements are collected. Thus the relationship of the <i>AssemblySection</i> elements directly reflects the structure of the <i>Assembly</i> .
<i>AssemblySection</i> *	element	Additional child <i>AssemblySection</i> elements that SHALL be gathered. The resulting set of <i>AssemblySection</i> elements SHALL be collected inside this <i>AssemblySection</i> .
<i>PageAssignedList</i> * New in JDF 1.	element	Defines the page sequence of an <i>AssemblySection</i> . One <i>PageAssignedList</i> element corresponds to one or more consecutive reader pages. The order of the <i>PageAssignedList</i> elements specifies the reader order of the assigned pages within the <i>AssemblySection</i> . <i>PageAssignedList</i> SHALL NOT be specified if child <i>AssemblySection</i> elements are present in this <i>AssemblySection</i> .

8.4.2 PageAssignedList

New in JDF 1.3

PageAssignedList specifies the metadata related to assigned pages.

Table 8.7: PageAssignedList Element

NAME	DATA TYPE	DESCRIPTION
<i>BroadsheetNumber</i> ?	integer	Specifies a broadsheet position within a single web product. Several <i>PageAssignedList</i> elements MAY show the same value for this attribute (e.g., in a 'tabloid-' or 'magazine production' on a newspaper press).
<i>LogicalPrinterSection</i> ?	string	Specifies a logical grouping of page-placement positions from the press managers point of view (see <i>@PagePlacementName</i> for details). A logical section NEED NOT correspond to a physical section.
<i>PageListIndex</i>	IntegerRangeList	List of the indices of the <i>PageData</i> elements of the <i>Assembly/PageList</i> specified in this <i>AssemblySection</i> .
<i>PagePlacementName</i> ?	string	Specifies the name of a position in a web product where a reader page is placed on a web press. In contrast to <i>PageList/PageData/@PageLabel</i> , <i>@PagePlacementName</i> specifies an identifier for a single page on a web-product level. Therefore, different <i>@PagePlacementName</i> values might be assigned to one single <i>PageList/PageData</i> element.

Example 8.1: Perfect Bound (Gathering)

New in JDF 1.4

Cover wrapped around a perfect bound (gathering) body.

```
<Assembly BindingSide="Left" Class="Parameter" ID="ASM000"
  Order="List" Status="Available">
  <AssemblySection AssemblyIDs="Ass_Cover">
    <AssemblySection AssemblyIDs="Ass_Body1"/>
    <AssemblySection AssemblyIDs="Ass_Body2"/>
    <AssemblySection AssemblyIDs="Ass_Insert"/>
    <AssemblySection AssemblyIDs="Ass_Body3"/>
    <AssemblySection AssemblyIDs="Ass_Body4"/>
  </AssemblySection>
</Assembly>
```

Example 8.2: Saddle-Stitched Brochure (Collecting)

New in JDF 1.4

```
<Assembly BindingSide="Left" Class="Parameter" ID="ASM000"
  Order="List" Status="Available">
  <AssemblySection AssemblyIDs="Ass_Cover">
    <AssemblySection AssemblyIDs="Ass_Body1">
      <AssemblySection AssemblyIDs="Ass_Body2">
        <AssemblySection AssemblyIDs="Ass_Body3">
          <AssemblySection AssemblyIDs="Ass_Body4"/>
        </AssemblySection>
      </AssemblySection>
    </AssemblySection>
  </AssemblySection>
</Assembly>
```

8.5 AssetListCreationParams

New in JDF 1.2

AssetListCreationParams provides controls for the **AssetListCreation** process.

Resource Properties

Resource Class: **Parameter**

Input of Processes: **AssetListCreation**

Table 8.8: AssetListCreationParams Resource

NAME	DATA TYPE	DESCRIPTION
<i>AssetTypes</i> ?	regExp	Specifies what type of assets are to be listed. The regular expression represents the <i>@MimeType</i> of the assets to be listed. The default behavior SHALL list everything. In case an asset requires a plug-in or extension in order to be opened in an application, this plug-in or extension SHOULD be listed as an asset.
<i>ListPolicy</i> ="All"	enumeration	Policy that defines which assets SHALL be added to the output <i>RunList</i> . Allowed values are: <i>All</i> – List all referenced assets, including those that are unavailable. <i>Available</i> – List all referenced assets, excluding those that are unavailable.
<i>FileSpec</i> (<i>SearchPath</i>) *	refelement	An ordered list of search paths that indicates where to search for referenced assets if they are not located in the same directory as the input asset. If no <i>FileSpec</i> is specified, the search path is the directory in which the input asset resides and SHALL NOT be searched recursively.

8.6 BendingParams

New in JDF 1.3

BendingParams describes the parameter set for a plate bending and punching device. A plate is bent and/or punched to fit the press cylinder.

RESOURCES

Resource Properties

Resource Class: Parameter

Input of Processes: **Bending**

Table 8.9: *BendingParams Resource*

NAME	DATA TYPE	DESCRIPTION
<i>Bend</i> ="true"	boolean	If "true", indicates that the device SHALL bend.
<i>Punch</i> ="true"	boolean	If "true", indicates that the device SHALL create registration punch holes.
<i>PunchType</i> ?	string	Name of the registration punch scheme (e.g., Bacher).

8.7 BinderySignature

New in JDF 1.2

The *BinderySignature* is conceptually a folding dummy. It represents multiple pieces of paper, which are folded together in the folder. It is a reusable, size-independent object.

One *BinderySignature* (when used with stripping) consists of one or more strip cells, which are created either explicitly (via *SignatureCell* elements) or implicitly (via the *@FoldCatalog* attribute or the *Fold* elements). *StrippingParams* describes some attributes for strip cells (using *StripCellParams*). The strip cells by themselves belong to a *BinderySignature*.

Each *BinderySignature* consumes a number of pages from the *PageList*. If no *SignatureCell* elements are specified, each *BinderySignature* consumes the number of pages as calculated from *@NumberUp* ($X*Y*2$) or *@FoldCatalog* (The integer value after the F (e.g., "F16-x" consumes 16 pages). If *SignatureCell* elements are specified, the number of pages consumed is the sum of the number of pages for all unique *SignatureCell*/*@SectionIndex*. The number of pages for each *SignatureCell*/*@SectionIndex* is one more than the maximum value of any *SignatureCell*/*@FrontPages* or *SignatureCell*/*@BackPages* for that *SignatureCell*/*@SectionIndex* (it is one more because *SignatureCell*/*@FrontPages* and *SignatureCell*/*@BackPages* begin at zero)

Resource Properties

Resource Class: Parameter

Resource referenced by: *StrippingParams*

Example Partition: "WebName"

Intent Pairing: *LayoutIntent*

Input of Processes: —

Table 8.10: *BinderySignature Resource (Sheet 1 of 4)*

NAME	DATA TYPE	DESCRIPTION
<i>AlignmentReference Web</i> ? New in JDF 1.4	NMTOKEN	The partition <i>@WebName</i> value of the reference web that <i>@WebCellAlignment</i> refers to.
<i>BinderySignatureType</i> e="Fold" New in JDF 1.3	enumeration	<i>@BinderySignatureType</i> specifies the type of <i>BinderySignature</i> . Allowed values are: <i>Die</i> – A layout defined by an existing die. <i>Fold</i> – A folding dummy (as defined in JDF 1.2). <i>Grid</i> – A grid based layout.
<i>BindingEdge</i> = "Left"	enumeration	Specifies the binding edge of this <i>BinderySignature</i> . <i>@BindingEdge</i> defines the spine side the folded <i>BinderySignature</i> . The opposite side defines the face side. Allowed values are: <i>Left</i> <i>Right</i> <i>Top</i> <i>Bottom</i> <i>None</i> – The spine is assumed to be on the left side of the <i>SignatureCell</i> and the face is assumed to be on the right side of the <i>SignatureCell</i>

Table 8.10: BinderySignature Resource (Sheet 2 of 4)

NAME	DATA TYPE	DESCRIPTION
<i>BindingOrientation</i> ? New in JDF 1.3	enumeration	<p>After folding a <i>BinderySignature</i>, the default reference corner is the lower left corner of the <i>BinderySignature</i>. The side coinciding with the last fold is the <i>@BindingEdge</i>, the other side of the reference corner the <i>@JogEdge</i>. <i>@BindingOrientation</i> is the named orientation describing the transformation of the default reference corner to the new reference corner defined by <i>@BindingEdge</i> and <i>@JogEdge</i>.</p> <p>For <i>BinderySignature</i> elements defined by <i>@FoldCatalog</i> or <i>Fold</i> elements, the default value of <i>@BindingOrientation</i>="Rotate0" if the folded <i>BinderySignature</i> has a closed head, otherwise <i>@BindingOrientation</i>="Flip0".</p> <p>For <i>BinderySignature</i> elements defined by <i>SignatureCell</i> elements, the default value <i>@BindingOrientation</i>="Rotate0".</p> <p>Note: In some cases, the first page of a <i>BinderySignature</i> is placed on the back side of the sheet.</p> <p>For details, see ▶ Table 2.4 Matrices and Orientation values for describing the orientation of a Component.Value is from: ▶ Orientation.</p>
<i>BleedBottom</i> ? New in JDF 1.5	double	<p>Value for the bleed at the bottom side of the <i>BinderySignature</i>.</p> <p>Note: See ▶ Section 8.7.1 On the use of Bleed.</p>
<i>BleedLeft</i> ? New in JDF 1.5	double	<p>Value for the bleed at the left side of the <i>BinderySignature</i>.</p> <p>Note: See ▶ Section 8.7.1 On the use of Bleed.</p>
<i>BleedRight</i> ? New in JDF 1.5	double	<p>Value for the bleed at the right side of the <i>BinderySignature</i>.</p> <p>Note: See ▶ Section 8.7.1 On the use of Bleed.</p>
<i>BleedTop</i> ? New in JDF 1.5	double	<p>Value for the bleed at the top side of the <i>BinderySignature</i>.</p> <p>Note: See ▶ Section 8.7.1 On the use of Bleed.</p>
<i>Bottling</i> ? New in JDF 1.6	enumeration	<p><i>@Bottling</i> SHALL specify the method to use for compensating the bottle angle, which is the slight rotation of a page needed to compensate for the rotation fault introduced when making cross-folds.</p> <p>Allowed values are:</p> <ul style="list-style-type: none"> All - Compensate all cross-folds. Last - Compensate only the bottle angle caused by the final fold. None - Do not compensate.
<i>FoldCatalog</i> ?	string	<p><i>@FoldCatalog</i> describes folding of the <i>BinderySignature</i>.</p> <p>Constraint: At least one of <i>SignatureCell</i>, <i>@FoldCatalog DieLayout</i> or <i>Fold</i> SHALL be specified. <i>@FoldCatalog</i> SHALL NOT be specified unless <i>@BinderySignatureType</i>="Fold".</p> <p>Values include those from: ▶ Fold Catalog.</p>
<i>FoldLay</i> ? New in JDF 1.4	enumeration	<p>Specification of the orientation applied to the substrate of all stacked webs before applying folding (only specified at root <i>BinderySignature</i> node, and would default to "Rotate0").</p> <p>Allowed value is from: ▶ Orientation</p>
<i>JogEdge</i> = "Top" New in JDF 1.3	enumeration	<p>Specifies the <i>@JogEdge</i> of the folded <i>BinderySignature</i>. The <i>@JogEdge</i> defines the head side of the folded <i>BinderySignature</i>. The opposite side defines the foot side.</p> <p>Allowed values are:</p> <ul style="list-style-type: none"> Left Right Top Bottom None - The head side is the top of the <i>SignatureCell</i>, the foot side is the bottom of the <i>SignatureCell</i>.

Table 8.10: BinderySignature Resource (Sheet 3 of 4)

NAME	DATA TYPE	DESCRIPTION
<i>NumberUp</i> = "1" Modified in JDF 1.3	XYPair	Specifies a regular, multi-up grid of <i>SignatureCell</i> elements into which content pages are mapped. The first value specifies the number of columns of <i>SignatureCell</i> elements, and the second value specifies the number of rows of <i>SignatureCell</i> elements in the multi-up grid (both numbers SHALL be positive integers). When the <i>BinderySignature</i> is partitioned (e.g., by <i>@WebName</i>), <i>@NumberUp</i> MAY be different from leaf to leaf.
<i>OutsideGutter</i> ? New in JDF 1.3	boolean	If <i>@BinderySignatureType</i> is "Grid", this boolean defines whether the outside margins of strip cells have to be taken into account (e.g., if <i>@OutsideGutter</i> is "false", the spine of the strip cells at the left border of the grid is considered to be 0).
<i>StaggerColumns</i> ? New in JDF 1.3	DoubleList	A list of values describing the staggering for subsequent columns. The number of entries in the list describes the periodicity of the staggering. Each value gives a factor of the strip cell height ((y value of <i>@TrimSize</i>) + <i>@TrimHead</i> + <i>@TrimFoot</i>) by which to shift the corresponding column. Note: Each value MAY be negative e.g., <i>@StaggerColumns</i> ="0.0 -0.333 0.666" specifies to shift each: <ul style="list-style-type: none"> • 3*n column up by 0% • 3*n+1 column down by 33.3% of the strip cell height • 3*n+2 column up by 66.6% of the strip cell height This element SHALL NOT be present unless <i>@BinderySignatureType</i> ="Grid". At most one of <i>@StaggerColumns</i> or <i>@StaggerRows</i> SHALL be specified.
<i>StaggerContinuous</i> ? New in JDF 1.3	boolean	Indicates if the <i>BinderySignature</i> SHALL be considered as a continuous repetition for staggering. This attribute SHALL NOT be present unless exactly one of <i>@StaggerRows</i> or <i>@StaggerColumns</i> is specified. Consider a grid with <i>m</i> columns and <i>n</i> rows with <i>@StaggerContinuous</i> ="true". If <i>@StaggerColumns</i> is specified, the <i>BinderySignature</i> SHALL be considered continuous with a height <i>H</i> equal to <i>n</i> multiplied by the strip cell height. If <i>@StaggerColumns</i> has a value of <i>y</i> for a certain column, that column is shifted up (assuming <i>y</i> > 0) by an amount equal to <i>y</i> multiplied by the strip cell height (in the same way as described for <i>@StaggerColumns</i>). All content (even partial cells) that falls above <i>H</i> (the top of <i>BinderySignature</i>) is shifted to the bottom such that the top of the shifted content is just below the original bottom cell in the column. For example, if <i>y</i> is 0.666, then the top 66.6% of the top cell is shifted to be just below the original bottom cell. Analogous for <i>@StaggerRows</i> .
<i>StaggerRows</i> ? New in JDF 1.3	DoubleList	A list of values describing the staggering for subsequent rows. The number of entries in the list describes the periodicity of the staggering. Each value gives a factor of the strip cell width ((x value of <i>@TrimSize</i>) + <i>@TrimFace</i> + <i>@Spine</i>) by which to shift the corresponding row. Note: Each value MAY be negative e.g., "0.0 0.333 -0.666" specifies to shift each <ul style="list-style-type: none"> • 3*n row right by 0% • 3*n+1 row right by 33.3% of the strip cell width • 3*n+2 row left by 66.6% of the strip cell width This element SHALL NOT be present unless <i>@BinderySignatureType</i> ="Grid". At most one of <i>@StaggerColumns</i> or <i>@StaggerRows</i> SHALL be specified.
<i>TrimBottom</i> ? New in JDF 1.5	double	Value for cutoff at the bottom side of the <i>BinderySignature</i> . Note: See ▶ Section 8.7.2 On the use of Trim.
<i>TrimLeft</i> ? New in JDF 1.5	double	Value for the cutoff at the left side of the <i>BinderySignature</i> . Note: See ▶ Section 8.7.2 On the use of Trim.
<i>TrimRight</i> ? New in JDF 1.5	double	Value for the cutoff at the right side of the <i>BinderySignature</i> . Note: See ▶ Section 8.7.2 On the use of Trim.
<i>TrimTop</i> ? New in JDF 1.5	double	Value for the cutoff at the top side of the <i>BinderySignature</i> . Note: See ▶ Section 8.7.2 On the use of Trim.

Table 8.10: BinderySignature Resource (Sheet 4 of 4)

NAME	DATA TYPE	DESCRIPTION
<i>WebCellAlignment</i> ? New in JDF 1.4	XYPair	Zero based <i>SignatureCell</i> index (coordinate) that the bottom left <i>SignatureCell</i> in this web is aligned with in the full web (only specified at the <i>@WebName</i> partition, and would default to "0 0"). See ▶ Figure 8-2: WebCellAlignment example 1, ▶ Figure 8-3: WebCellAlignment example 2 and ▶ Figure 8-4: WebCellAlignment example 3. Also, the “stacking” of the webs is implied by the order of the webs within the <i>BinderySignature</i> . The back side of a <i>@WebName</i> partition of a <i>BinderySignature</i> will be touching the front side of the <i>@WebName</i> partition of the <i>BinderySignature</i> that follows it in the JDF file.
<i>DieLayout</i> ? New in JDF 1.3	refelement	The layout as defined by a pre-existing die. <i>DieLayout</i> SHALL be present when <i>@BinderySignatureType</i> ="Die".
<i>Fold</i> *	element	Describes the folding operations in the sequence in which they are to be carried out. When both <i>Fold</i> and <i>@FoldCatalog</i> are specified, <i>@FoldCatalog</i> defines the topology of the folding scheme, and the specifics of each individual fold are described by the <i>Fold</i> elements. The <i>Fold</i> elements have precedence. <i>Fold</i> SHALL NOT be specified if <i>SignatureCell</i> elements are present. <i>Fold</i> SHALL NOT be specified unless <i>@BinderySignatureType</i> ="Fold".
<i>SignatureCell</i> *	element	Describes the <i>SignatureCell</i> elements used in this <i>BinderySignature</i> . <i>SignatureCell</i> elements are ordered in X-Y direction starting at the lower left corner of the <i>BinderySignature</i> . When both <i>SignatureCell</i> and <i>@FoldCatalog</i> are specified, <i>@FoldCatalog</i> defines the topology of the folding scheme, and the specifics of each individual signature cell are described by the <i>SignatureCell</i> elements. The <i>SignatureCell</i> elements SHALL have precedence. <i>SignatureCell</i> SHALL NOT be specified if <i>Fold</i> elements are present.

8.7.1 On the use of Bleed

New in JDF 1.5

If any strip cell belonging to the *BinderySignature* has any bleed value > 0, where a bleed value is *StripCellParams*/*@BleedFace*, *StripCellParams*/*@BleedSpine*, *StripCellParams*/*@BleedHead* or *StripCellParams*/*@BleedFoot*, then none of the *BinderySignature* /*@BleedLeft*, *BinderySignature* /*@BleedRight*, *BinderySignature* /*@BleedTop* and *BinderySignature* /*@BleedBottom* SHALL be applied.

If any strip cell belonging to the *BinderySignature* has a *StripCellParams*/margin value > 0 (where margin value is: *@Spine*, *@TrimFace*, *@TrimFoot*, *@TrimHead*, *@TrimSize*, *@BackOverfold*, *@FrontOverfold*, *@CutWidthFoot*, *@CutWidthHead* or *@MillingDepth*), then none of *BinderySignature*/*@BleedLeft*, *BinderySignature* /*@BleedRight*, *BinderySignature* /*@BleedTop* and *BinderySignature* /*@BleedBottom* SHALL be applied.

8.7.2 On the use of Trim

New in JDF 1.5

The attributes *@TrimBottom*, *@TrimLeft*, *@TrimRight* and *@TrimTop* are added around the rectangle that is composed of the strip cells belonging to the *BinderySignature*. The strip cell includes the margins specified by *StripCellParams*. *Layout*/*Position*/*@Orientation* is applied to the *BinderySignature*/*@TrimLeft*, *BinderySignature* /*@TrimRight*, *BinderySignature* /*@TrimTop* and *BinderySignature* /*@TrimBottom* as well.

Figure 8-1: BinderySignature trims

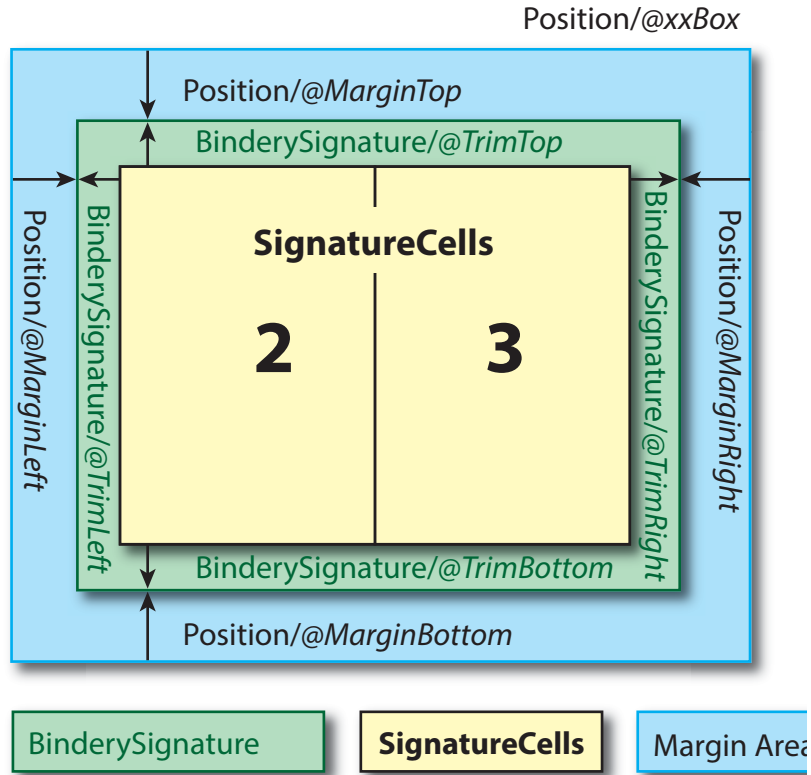

8.7.3 Web cell alignment

Example 8.3: Web cell alignment - Example 1

```
<BinderySignature AlignmentReferenceWeb="Web1" Class="Parameter"
  FoldCatalog="F16-6" ID="BS001" PartIDKeys="WebName" Status="Available">
  <BinderySignature NumberUp="4 2" WebCellAlignment="0 0" WebName="Web1"/>
  <BinderySignature NumberUp="4 2" WebCellAlignment="0 0" WebName="Web2"/>
</BinderySignature>
```

Figure 8-2: WebCellAlignment example 1

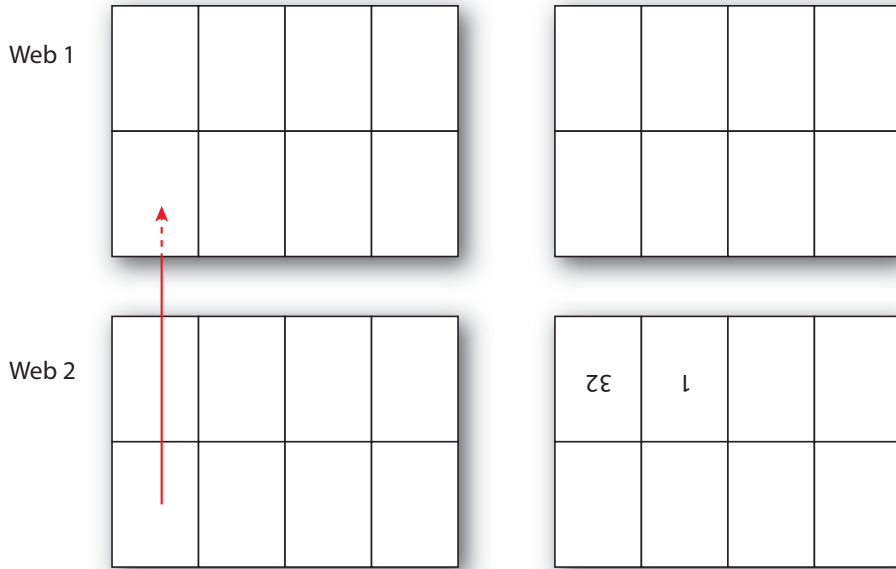

Example 8.4: Web cell alignment - Example 2

```
<BinderySignature AlignmentReferenceWeb="Web1" Class="Parameter"
  FoldCatalog="F16-6" ID="BS001" PartIDKeys="WebName" Status="Available">
  <BinderySignature NumberUp="2 2" WebCellAlignment="1 0" WebName="Web1"/>
  <BinderySignature NumberUp="4 2" WebCellAlignment="0 0" WebName="Web2"/>
</BinderySignature>
```

Figure 8-3: WebCellAlignment example 2

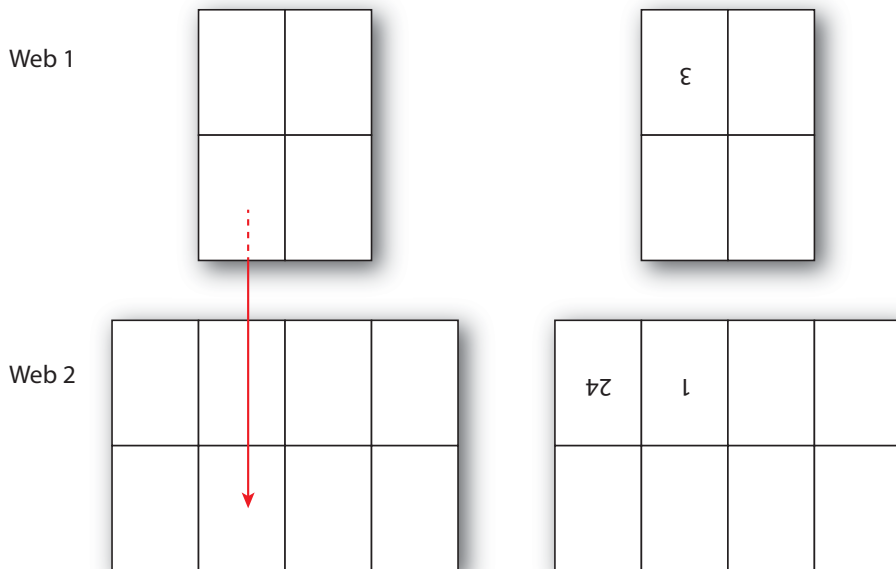

Example 8.5: Web cell alignment - Example 3

```
<BinderySignature AlignmentReferenceWeb="Web1" Class="Parameter"
  FoldCatalog="F16-6" ID="BS001" PartIDKeys="WebName" Status="Available">
  <BinderySignature NumberUp="2 2" WebCellAlignment="0 0" WebName="Web1"/>
  <BinderySignature NumberUp="4 2" WebCellAlignment="0 0" WebName="Web2"/>
</BinderySignature>
```

Figure 8-4: WebCellAlignment example 3

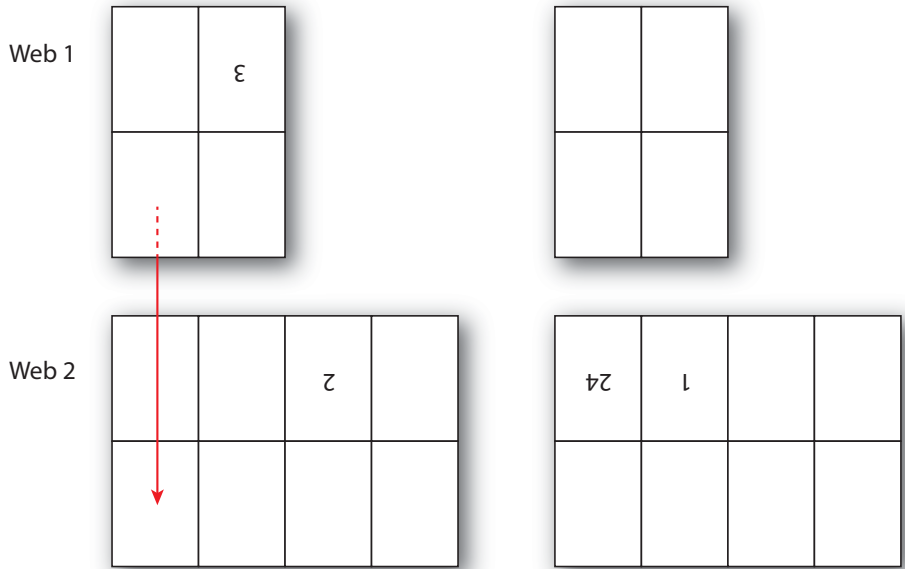

Example 8.6: Pseudo Code to Generate Page Count from SignatureCell Elements

New in JDF 1.4

```
maxSectionIndexSeen = 0
maxSectionPages = [0]
for sc in BinderySignature/SignatureCell
  si = sc@SectionIndex
  if ( si > maxSectionIndexSeen)
    for index from maxSectionIndexSeen to si - 1:
      maxSectionPages.append(0)
    maxSectionIndexSeen = si
  for page in sc@FrontPages
    maxSectionPages[si] = max(maxSectionPages[si],page)
  for page in sc@BackPages
    maxSectionPages[si] = max(maxSectionPages[si],page)
totalPages = 0
for sectionIndex from 0 to maxSectionIndexSeen
  totalPages += 1 + maxSectionPages[sectionIndex]
return totalPages
```

8.7.4 SignatureCell

SignatureCell elements describe a set of individual page cells in a **BinderySignature**.

Note: “Page number” in the table below refers to finished pages from the **PageList** numbered from 0 to n, as opposed to folio pages, which are the numbers that appear in print with the content of the document; the difference being that pages without folio numbering are counted. As the **BinderySignature** is a reusable object, the page numbers refer to finished pages numbered from 0 to n, as if this **BinderySignature** were the only section of the **Assembly**. The consuming device needs to calculate the final product page number using the **Assembly** and **StrippingParams/@SectionList**. The **BinderySignature** cells SHALL NOT contain final page numbers unless **Assembly/@Order="None"**.

Table 8.11: SignatureCell Element

NAME	DATA TYPE	DESCRIPTION
BackFacePages ? Deprecated in JDF 1.4	IntegerList	Page numbers for the back pages forming a foldout. Deprecation note: Starting with JDF 1.4 , use @FaceCells to describe foldouts.
BackPages ?	IntegerList	Page numbers of the back pages of a SignatureCell . The number of entries in @FrontPages and @BackPages SHALL be identical. The entries with an identical index in @FrontPages and @BackPages are back-to-back in the layout. If not specified, the layout is one-sided.
BackSpread ? New in JDF 1.5	IntegerList	List of indices of SignatureCell elements that are combined into a spread on the back side.
BottleAngle ? Deprecated in JDF 1.6	double	Indicates the bottle angle, which is the slight rotation of the SignatureCell needed to compensate for the rotation fault introduced when making cross-folds.
BottleAxis ? Deprecated in JDF 1.6	enumeration	Indicates the point around which the cell is bottled. Allowed values are: FaceFoot FaceHead SpineFoot SpineHead
FaceCells ? New in JDF 1.4	IntegerList	List of indices of SignatureCell elements that form a foldout together with this SignatureCell . The SignatureCell that contains @FaceCells is the parent of the foldout, typically the page that is attached to the spine. Details of each foldout page are described by a SignatureCell element.
FrontFacePages ? Deprecated in JDF 1.4	IntegerList	Page numbers for the front pages forming a foldout. Deprecation note: Starting with JDF 1.4 , use @FaceCells to describe foldouts.
FrontPages ?	IntegerList	Page numbers of the front pages of a SignatureCell . Multiple page cells with the same properties except for the pages to which they are assigned MAY be summarized as one SignatureCell with multiple entries in @FrontPages .
FrontSpread ? New in JDF 1.5	IntegerList	List of indices of SignatureCell elements that are combined into a spread on the front side.
Orientation = "Up" Modified in JDF 1.3	enumeration	Indicates the orientation of the SignatureCell . Allowed values are: Down – 180° rotation. Left – 90° counter-clockwise rotation. New in JDF 1.3 Right – 270° counter-clockwise rotation New in JDF 1.3 Up – 0° rotation.
SectionIndex = "0"	integer	Unique logical index of the page section that are to fill this SignatureCell . This is an indirect logical index. The actual section index is defined in StrippingParams/@SectionList .
StationName ? New in JDF 1.3	string	The name of the 1-up station in the die layout. Constraint: if BinderySignature/@BinderySignatureType="Die" , this element SHOULD be specified. Constraint: if BinderySignature/@BinderySignatureType="Die" and BinderySignature/DieLayout contains more than 1 Station , this attribute SHALL be specified.

Example 8.7: StrippingParams: Foldout Using FaceCells

New in JDF 1.4

```
<!--Stripping Foldout example corresponding to spec example n.6.5 - with new
attribute FaceCells-->
<StrippingParams Class="Parameter" ID="r000005"
PartIDKeys="CellIndex" Status="Available">
  <BinderySignatureRef rRef="r000006"/>
  <StrippingParams CellIndex="0">
    <!--stripcell for the folded out foldout(front page=4)-->
    <StripCellParams TrimSize="200 400"/>
  </StrippingParams>
  <StrippingParams CellIndex="1">
    <!--stripcell for the inner page of the foldout foldout(front page=5)-->
    <StripCellParams TrimSize="300 400"/>
  </StrippingParams>
  <StrippingParams CellIndex="2">
    <!--stripcell for the inner page of the foldout foldout(front page=0)-->
    <StripCellParams TrimSize="320 400"/>
  </StrippingParams>
</StrippingParams>
<BinderySignature Class="Parameter" ID="r000006" Status="Available">
  <!--this is the foldout foldout cell-->
  <SignatureCell BackPages="3" FrontPages="4"/>
  <!--this cell is the inner page of the foldout, i.e. the page that is
attached to the spine The new attribute FaceCells refers to the cell(s)
that describe the foldout; in this case the cell to the left. The front
and back pages of the foldout are listed in the respective cell(s)
-->
  <SignatureCell BackPages="2" FaceCells="0" FrontPages="5"/>
  <!--this is the cell that has no foldout-->
  <SignatureCell BackPages="1" FrontPages="0"/>
</BinderySignature>
```

8.8 BlockPreparationParams

New in JDF 1.1

BlockPreparationParams describes the settings of a **BlockPreparation** process.

Resource Properties

Resource Class: **Parameter**
 Intent Pairing: **BindingIntent**
 Input of Processes: **BlockPreparation**

Table 8.12: BlockPreparationParams Resource

NAME	DATA TYPE	DESCRIPTION
<i>Backing</i> ?	double	Backing distance in points. See @Backing : ▶ Figure 8-5: Backing and Rounding measurements for TightBacking.
<i>Rounding</i> ?	double	Rounding distance in points. See @Rounding : ▶ Figure 8-5: Backing and Rounding measurements for TightBacking.
<i>TightBacking</i> ?	enumeration	Definition of the geometry of the back of the book block. Allowed value is from: ▶ TightBacking.
RegisterRibbon *	refelement	Description of the register ribbons that are included within the book block.

Figure 8-5: Backing and Rounding measurements for TightBacking

@Backing

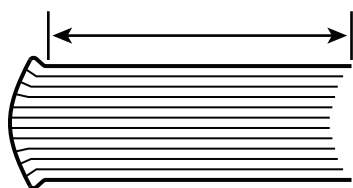

@Rounding

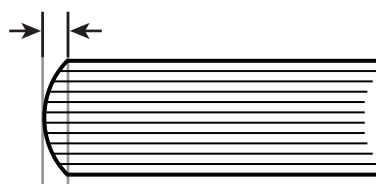

8.9 BoxFoldingParams

New in JDF 1.3

BoxFoldingParams defines the parameters for folding and gluing blanks to folded flat boxes in a box folder-gluer device.

Resource Properties

Resource Class: Parameter

Input of Processes: **BoxFolding**

Table 8.13: BoxFoldingParams Resource

NAME	DATA TYPE	DESCRIPTION
<i>BlankDimensionsX</i> ?	DoubleList	<i>@BlankDimensionsX</i> contains a list of the X positions of folds for an unfolded box beginning from the origin of the coordinate system (left side) increasing from minimum to maximum. These positions are described in ▶ Section 8.9.1 BoxFoldingType attribute values. <i>@BlankDimensionsX</i> SHALL NOT be specified unless <i>@BoxFoldingType</i> is also specified.
<i>BlankDimensionsY</i> ?	DoubleList	<i>@BlankDimensionsY</i> contains a list of the Y positions of folds for an unfolded box beginning from the origin of the coordinate system (bottom side) increasing from minimum to maximum. These positions are described in ▶ Section 8.9.1 BoxFoldingType attribute values. <i>@BlankDimensionsY</i> SHALL NOT be specified unless <i>@BoxFoldingType</i> is also specified.
<i>BoxFoldingType</i> ?	enumeration	Basic predefined folding types. See the drawings referenced from each defined value below. Each drawing is shown from the print side with the lid at the top. Each type MAY be described with a sequence of BoxFoldAction elements. The most common sequences (folding types) are predefined, All other are 'special' and SHALL be described in detail. Allowed values are from: ▶ Table 8.14 BoxFoldingType Attribute Values.
BoxApplication * Deprecated in JDF 1.4	element	Application work step in a box folder-gluer. The sequence of BoxFoldAction , BoxApplication and GlueLine elements defines the sequence of work steps. The first element is applied first. Application SHOULD be described with a combined Inserting process. Deprecation note: Starting with JDF 1.4, a combined process that includes the BoxFolding and Inserting processes replaces BoxApplication .
BoxFoldAction *	element	Individual work step in a box folder-gluer. The sequence of BoxFoldAction , BoxApplication and GlueLine elements SHALL define the sequence of work steps and MAY occur in any order. The first element SHALL be applied first.
GlueLine *	element	Specification of a glue line. The GlueLine is applied to the blank in the coordinate system of the folder gluer at the state after all prior BoxFoldActions and BoxApplication elements have been applied. The sequence of BoxFoldAction , BoxApplication and GlueLine elements defines the sequence of work steps and MAY occur in any order. The first element SHALL be applied first.

8.9.1 BoxFoldingType attribute values

The following table shows the allowed values for *@BoxFoldingType*. Each type corresponds to a particular style of folding shown in the figure column. The description column contains a list of 'dimension/action' for each fold. Dimension ref-

RESOURCES

references a specific value from **BoxFoldingParams** where X0 is the first value from **@BlankDimensionsX**, and Y0 is the first value from **@BlankDimensionsY**. X1/Y1 refer to the appropriate second value etc. Action references a specific value from **BoxFoldingParams/BoxFoldAction/@Action**, see ▶ Table 8.16 Action Attribute Values.

Notes:

- Shown from print side, lid at the top, arrow is transport direction in folder-gluer.
- In the folder-gluer the blank box is fed with the print side down.
- From this point of view all folds are made toward the -z axis.
- For front and back folds, pay attention to transport direction

Table 8.14: BoxFoldingType Attribute Values

VALUE	FIGURE	DESCRIPTION
Type00		Special type for boxes that are not pre-defined.
Type01		X0 LongPreFoldLeftToRight X2 LongPreFoldRightToLeft X1 LongFoldLeftToRight X3 LongFoldRightToLeft
Type02		X3 LongPreFoldLeftToRight X1 LongPreFoldRightToLeft X0 LongFoldLeftToRight X2 LongFoldRightToLeft
Type03		X0 LongPreFoldLeftToRight X2 LongPreFoldRightToLeft X2/Y1 FrontFoldComplete X4/Y1 FrontFoldComplete X1/Y1 FrontFoldCompleteDiagonal X3/Y1 FrontFoldCompleteDiagonal X1 LongFoldLeftToRight X3 LongFoldRightToLeft

Table 8.14: BoxFoldingType Attribute Values

VALUE	FIGURE	DESCRIPTION
Type04	<p>The diagram shows a box with a top flap and side flaps. Dimensions are labeled as follows: Y0 (height of top flap), Y1 (height of side flap), Y2 (height of main body), Y3 (height of top flap), Y4 (height of top flap), and Y5 (total height). X0 (width of top flap), X1 (width of side flap), X2 (width of main body), X3 (width of top flap), and X4 (total width).</p>	<p>X3 LongPreFoldLeftToRight X1 LongPreFoldRightToLeft X1/Y1 FrontFoldComplete X3/Y1 FrontFoldComplete X0/Y1 FrontFoldCompleteDiagonal X2/Y1 FrontFoldCompleteDiagonal X0 LongFoldLeftToRight X2 LongFoldRightToLeft</p>
Type10	<p>The diagram shows a box with a top flap and side flaps. Dimensions are labeled as follows: Y0 (height of top flap), Y1 (height of side flap), and Y2 (total height). X0 (width of top flap), X1 (width of side flap), and X2 (total width).</p>	<p>X0 LongPreFoldLeftToRight X1 LongPreFoldRightToLeft</p>
Type11	<p>The diagram shows a box with a top flap and side flaps. Dimensions are labeled as follows: Y0 (height of top flap), Y1 (height of side flap), and Y2 (total height). X0 (width of top flap), X1 (width of side flap), and X2 (total width).</p>	<p>X0/Y0 FrontFoldComplete X2/Y0 FrontFoldComplete X0/Y2 BackFoldComplete X2/Y2 BackFoldComplete X1/Y0 FrontFoldCompleteDiagonal X1/Y2 BackFoldCompleteDiagonal X0 LongFoldLeftToRight X2 LongFoldRightToLeft</p>
Type12	<p>The diagram shows a box with a top flap and side flaps. Dimensions are labeled as follows: Y0 (height of top flap), Y1 (height of side flap), and Y2 (total height). X0 (width of top flap), X1 (width of side flap), X2 (width of main body), X3 (width of top flap), and X4 (total width).</p>	<p>X1/Y0 FrontFoldCompleteDiagonal X1/Y2 BackFoldCompleteDiagonal X0 LongFoldLeftToRight X2 LongFoldRightToLeft</p>
Type13	<p>The diagram shows a box with a top flap and side flaps. Dimensions are labeled as follows: Y0 (height of top flap), Y1 (height of side flap), and Y2 (total height). X0 (width of top flap), X1 (width of side flap), X2 (width of main body), X3 (width of top flap), and X4 (total width).</p>	<p>X0/Y0 FrontFoldComplete X2/Y0 FrontFoldComplete X0/Y2 BackFoldComplete X2/Y2 BackFoldComplete X1/Y0 FrontFoldCompleteDiagonal X1/Y2 BackFoldCompleteDiagonal X0 LongFoldLeftToRight X2 LongFoldRightToLeft</p>

Table 8.14: BoxFoldingType Attribute Values

VALUE	FIGURE	DESCRIPTION
Type15		<p>X0/Y0 FrontFoldComplete X2/Y0 FrontFoldComplete X4/Y0 FrontFoldComplete X0/Y2 BackFoldComplete X2/Y2 BackFoldComplete X4/Y2 BackFoldComplete X1/Y0 FrontFoldCompleteDiagonal X1/Y0 FrontFoldCompleteDiagonal X1/Y2 BackFoldCompleteDiagonal X3/Y2 BackFoldCompleteDiagonal X0 LongFoldLeftToRight X3 LongFoldRightToLeft X2 LongFoldRightToLeft</p>
Type20		<p>X0 LongFoldLeftToRight X3 LongFoldRightToLeft</p>

8.9.2 BoxApplication

Deprecated in JDF 1.4

8.9.3 BoxFoldAction

BoxFoldAction describes an action in the folder-gluer that is perpendicular or diagonal to the movement path of the blank.

Table 8.15: BoxFoldAction Element

NAME	DATA TYPE	DESCRIPTION
Action	enumeration	<p>@Action describes an individual action in the folder gluer. See ▶ Figure 8-6: Folding examples for some values of BoxFoldAction/@Action. Allowed values are from: ▶ Table 8.16 Action Attribute Values.</p>
FoldIndex	XYPair	<p>Pair of indices that identify the upper right corner of the flap or fold that is affected by this BoxFoldAction. The first value of the XYPair SHALL refer to an indexed fold that is labeled X0...Xn in the specific fold template that is selected by BoxFoldingParams/@BoxFoldingType as shown in ▶ Table 8.14 BoxFoldingType Attribute Values. The second value of the XYPair shall refer to an indexed fold that is labeled Y0...Yn in the specific fold template that is selected by BoxFoldingParams/@BoxFoldingType as shown in ▶ Table 8.14 BoxFoldingType Attribute Values. If either X or Y spans multiple flaps, it SHALL be set to -1.</p>
GlueLine *	element	<p>Specification of glue lines needed to glue the Component described in this BoxApplication. The GlueLines are applied to the Component in the coordinate system of the BoxApplication/Component. The GlueLines applied to the blank are specified in BoxFoldingParams/GlueLine.</p>

Table 8.16: Action Attribute Values

VALUE	DESCRIPTION
LongFoldLeftToRight	
LongFoldRightToLeft	
LongPreFoldLeftToRight	
LongPreFoldRightToLeft	
FrontFoldComplete	
FrontFoldDiagonal	
FrontFoldCompleteDiagonal	
BackFoldComplete	
BackFoldDiagonal	
BackFoldCompleteDiagonal	
ReverseFold	A "ReverseFold" is topologically equivalent to "FrontFoldDiagonal" but uses different equipment with other restrictions on Media weight and size and is therefore specified individually.
Milling	
Rotate90	90° counter-clockwise rotation
Rotate180	180° rotation
Rotate270	90° clockwise rotation

Example 8.8: BoxFoldingParams/BoxFoldAction

For instance, processing a Type01 blank has the following actions:

```
<BoxFoldingParams BoxFoldingType="Type01" Class="Parameter"
  ID="r_000004" Status="Available">
  <BoxFoldAction Action="LongPreFoldLeftToRight" FoldIndex="0 -1"/>
  <BoxFoldAction Action="LongPreFoldRightToLeft" FoldIndex="2 -1"/>
  <BoxFoldAction Action="LongFoldLeftToRight" FoldIndex="1 -1"/>
  <BoxFoldAction Action="LongFoldRightToLeft" FoldIndex="3 -1"/>
</BoxFoldingParams>
```

Figure 8-6: Folding examples for some values of BoxFoldAction/@Action

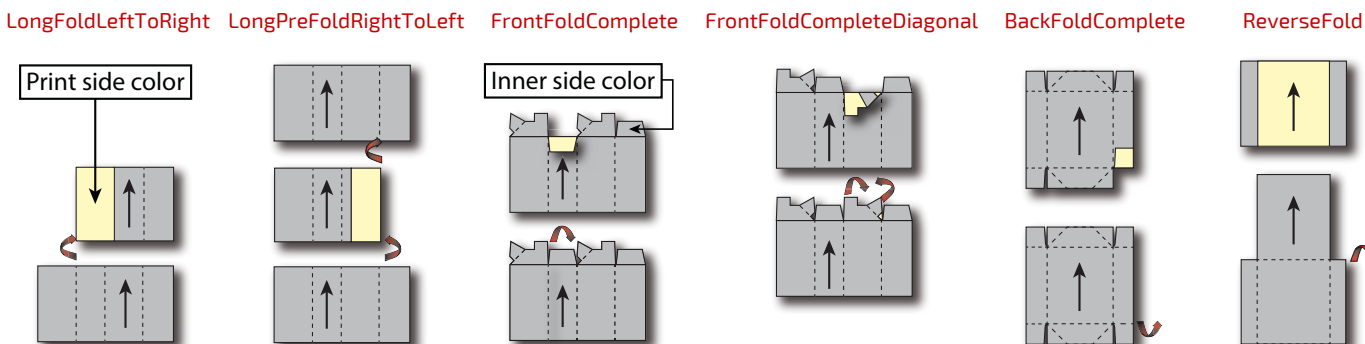

8.10 BoxPackingParams

New in JDF 1.1

BoxPackingParams defines the parameters for packing a box of components. Details of the box used for BoxPacking can be found in the Component (Box) resource that is also an input of the BoxPacking process.

Resource Properties

Resource Class: Parameter

Intent Pairing: [PackingIntent](#)

Input of Processes: [BoxPacking](#)

Table 8.17: [BoxPackingParams](#) Resource (Sheet 1 of 2)

NAME	DATA TYPE	DESCRIPTION
BoxType ? New in JDF 1.6	enumeration	@BoxType specifies the general category of the package to be packed. Allowed values are: Box – Boxes are convenience packaging and are not envisioned to be protection for shipping. Carton – Cartons envisioned to be protection for shipping. Envelope – Envelopes are packages that are envisioned for shipping. Tube – Tubes are cylinder shaped cartons that are envisioned for shipping.
BoxTypeDetails ? New in JDF 1.6	string	Additional details of @BoxType . @BoxType MAY be a site specific identifier. Values include: Branded Carton Easter Bunny Box Neutral Carton
Columns ? New in JDF 1.4	integer	Columns per shipping box. Columns are in the 3rd Dimension in ▶ Figure 8-7: Box packing , and are thus not illustrated.
ComponentOrientation ? New in JDF 1.4	enumeration	Defines the coordinate pair that is facing the bottom of the box, defining the horizontal plane. Allowed values are: XY – Axis X and Y XZ – Axis X and Z YZ – Axis Y and Z
ComponentsPerRow ? New in JDF 1.3	integer	Components per row in the shipping box, as illustrated by A in ▶ Figure 8-7: Box packing . If the Components represent Bundles , the number of Bundles SHALL be specified.
Copies ? New in JDF 1.4	integer	Number of copies in the box. @Copies SHALL NOT be specified if @MaxWeight is present.
FillMaterial ?	NMTOKEN	Material to fill boxes that are not completely filled, as illustrated by F in ▶ Figure 8-7: Box packing . Values include: Any – Explicit request for system specified filling. BlisterPack None – Explicit request for no filling. Paper Styrofoam
Layers ? New in JDF 1.3	integer	Layers per shipping box, as illustrated by L in ▶ Figure 8-7: Box packing .
MaxWeight ? New in JDF 1.4	double	Maximum weight of a packed box in grams. @MaxWeight SHALL NOT be specified if @Copies is present.
Pattern ?	string	Name of the box packing pattern. Used to store a predefined pattern that defines the layers and positioning of individual component in the box or carton.
Rows ? New in JDF 1.3	integer	Rows per shipping box, as illustrated by R in ▶ Figure 8-7: Box packing .

Table 8.17: BoxPackingParams Resource (Sheet 2 of 2)

NAME	DATA TYPE	DESCRIPTION
<i>Ties</i> ? New in JDF 1.3	IntegerList	Number of tie sheets at each row, as illustrated by T in ▶ Figure 8-7: Box packing. The first value is outside the first row, the next value between the first and second row and so forth. If more rows than values are specified, counting SHALL restart at the 0 position. If fewer rows than values are specified, all tie sheets that are not adjacent to a row SHALL be ignored.
<i>UnderLays</i> ? New in JDF 1.3	IntegerList	Number of underlay sheets at each layer, as illustrated by U in ▶ Figure 8-7: Box packing. The first value is underneath the bottom layer, the next value above the first layer and so forth. If more layers than values are specified, counting SHALL restart at the 0 position. If fewer layers than values are specified, all underlay sheets that are not adjacent to a layer SHALL be ignored.

Figure 8-7: Box packing

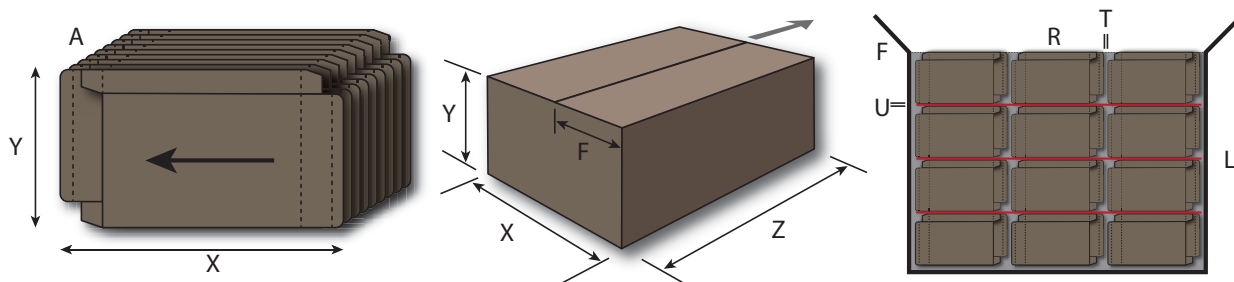

8.11 BufferParams

New in JDF 1.1

BufferParams provides controls for **Buffer** process.

Resource Properties

Resource Class: Parameter

Input of Processes: **Buffer**

Table 8.18: BufferParams Resource

NAME	DATA TYPE	DESCRIPTION
<i>MinimumWait</i> ?	duration	Minimum amount of time that an individual resource SHALL be buffered.

8.12 Bundle

New in JDF 1.1

Bundles are used to describe various kinds of sets of packing units such as boxes, cartons and pallets.

Note: *Bundle* resources MAY be created by many press or postpress processes and not only **Bundling**.

The coordinate system of a *Bundle* is defined by the orientation of the first, i.e. bottom item in the *Bundle*. See ▶ Figure 8-8: Bundle coordinate system.

Resource Properties

Resource Class: Quantity

Resource referenced by: *Bundle*, *PalletizingParams*

Input of Processes:

Table 8.19: Bundle Resource

NAME	DATA TYPE	DESCRIPTION
<i>BundleType</i> ="Stack" Modified in JDF 1.5	enumeration	Allowed values are: BoundSet – Stack of components that are bound together. Box Carton CollectedStack – Components collected on a saddle, result of Collecting process CompensatedStack – Loose stack of compensated components Pallet Roll – Rolled components on a print Roll. Sheet – Multiple individual items printed onto one sheet. SheetStream – Stream of individual sheets that are continuously moved from one device to another (e.g., in an inline digital finishing device). New in JDF 1.5 Stack – Loose stack of equally stacked components. StrappedStack – Strapped stack of equally stacked components. StrappedCompensatedStack – Strapped stack of compensated components. WrappedBundle
<i>FolioCount</i> ?	integer	Total amount of individual finished pages that this bundle contains. If not specified, it SHALL be calculated from the individual BundleItem elements.
<i>ReaderPageCount</i> ?	integer	Total amount of individual reader pages that this bundle contains. If not specified, it SHALL be calculated from the individual BundleItem elements.
<i>SheetCount</i> ? New in JDF 1.5	integer	Total number of physical sheets that this Bundle contains.
<i>TotalAmount</i> ?	integer	Total amount of individual products that this bundle contains. If the bundle contains one or more Bundle [xecontains (@ <i>ComponentType</i> , " FinalProduct ")], @ <i>TotalAmount</i> refers to the number of final products. Note: This is neither always the next level of BundleItem nor the lowest level of BundleItem . For instance, the next level MAY be the boxes in a carton, whereas the lowest level MAY be the sheets comprising the brochure. The correct number in this example would be the number of brochures. If not specified, it SHALL be calculated from the individual BundleItem elements.
BundleItem *	element	References to the individual items that form this Bundle .

8.12.1 BundleItem

A **Bundle** is described as a set of **BundleItem** elements. Since **BundleItem** elements reference **Bundle** resources which themselves MAY reference further **Bundle** resources, the structure is recursive.

Table 8.20: BundleItem Element

NAME	DATA TYPE	DESCRIPTION
<i>Amount</i>	integer	Number of this type of item.
<i>ItemName</i> ? New in JDF 1.2	NMTOKEN	Name of the bundle item. Used for referencing individual BundleItem elements in a Bundle .
<i>Orientation</i> ?	enumeration	Named orientation of the Bundle respective to the Bundle coordinate system. For details, see ▶ Table 2.4 Matrices and Orientation values for describing the orientation of a Component. At most one of @ <i>Orientation</i> or @ <i>Transformation</i> SHALL be specified. Allowed value is from: ▶ Orientation.
<i>Transformation</i> ?	matrix	Orientation of the Bundle respective to the Bundle coordinate system. At most one of @ <i>Orientation</i> or @ <i>Transformation</i> SHALL be specified.
Bundle	refelement	Reference to a Bundle that is part of this Bundle .

Figure 8-8: Bundle coordinate system

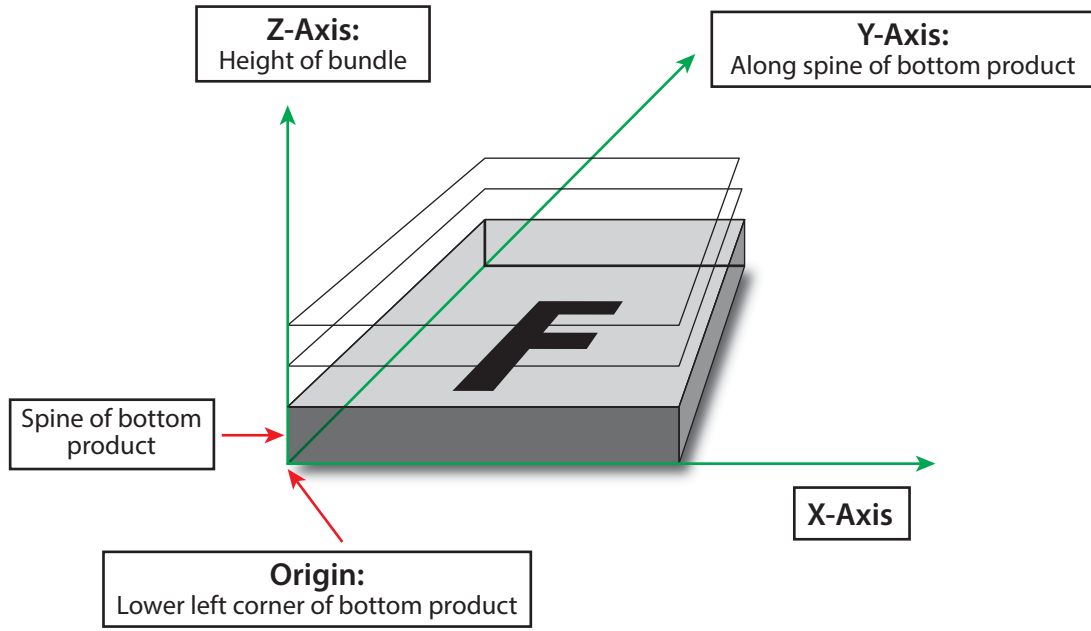

Example 8.9: Bundle: Boxing and Palletizing

The following example code shows a **JDF** that describes boxing and palletizing for 4200 books. The appropriate **Bundle** elements have orange tags and magenta Attributes. The resources have not yet been completely filled in.

```
<?xml version="1.0" encoding="UTF-8"?>
<JDF ID="Bundle" JobPartID="ID20" Status="Waiting" Type="ProcessGroup"
  Version="1.6" xmlns="http://www.CIP4.org/JDFSchema_1_1">
  <!-- The BoxPacking Process consumes the thing to pack and the boxes-->
  <!-- The BoxPacking Process creates packed boxes -->
  <JDF ID="n0235" JobPartID="ID21" Status="Waiting" Type="BoxPacking">
    <ResourceLinkPool>
      <ComponentLink ProcessUsage="Box" Usage="Input" rRef="BoxID"/>
      <BoxPackingParamsLink Usage="Input" rRef="BoxParamsID"/>
      <ComponentLink Usage="Input" rRef="ComponentID"/>
      <ComponentLink Usage="Output" rRef="PackedBoxID"/>
    </ResourceLinkPool>
    <!-- The BoxPacking Process has the following local resources -->
    <ResourcePool>
      <BoxPackingParams Class="Parameter" ID="BoxParamsID" Status="Available"/>
      <Component Amount="100" Class="Quantity" ComponentType="Sheet"
        ID="BoxID" Status="Available"/>
    </ResourcePool>
  </JDF>
  <ResourcePool>
    <!-- This Component describes a Box with 42 Books -->
    <Component Amount="100" Class="Quantity" ComponentType="Sheet"
      ID="PackedBoxID" Status="Unavailable">
      <Bundle BundleType="Box" TotalAmount="42">
        <BundleItem Amount="42">
          <ComponentRef rRef="ComponentID"/>
        </BundleItem>
      </Bundle>
    </Component>
    <Component Amount="4200" Class="Quantity" ComponentType="Sheet"
      ID="ComponentID" Status="Available"/>
    <!-- This Component describes the contents of the pallet: 100
      Boxes w. 42 Books -->
    <Component Amount="10" Class="Quantity" ComponentType="Sheet"
      ID="palletContentsID" Status="Unavailable">
      <Bundle BundleType="Pallet" TotalAmount="420">
        <BundleItem Amount="10">
          <ComponentRef rRef="PackedBoxID"/>
        </BundleItem>
      </Bundle>
    </Component>
  </ResourcePool>
  <JDF ID="n0239" JobPartID="ID22" Status="Waiting" Type="Palletizing">
    <ResourceLinkPool>
      <ComponentLink Usage="Input" rRef="PackedBoxID"/>
      <PalletLink Usage="Input" rRef="palletID"/>
      <PalletizingParamsLink Usage="Input" rRef="palletParamsID"/>
      <ComponentLink Usage="Output" rRef="palletContentsID"/>
    </ResourceLinkPool>
    <ResourcePool>
      <Pallet Amount="10" Class="Consumable" ID="palletID"
        PalletType="Euro800x600" Status="Available"/>
      <PalletizingParams Class="Parameter" ID="palletParamsID" Status="Available"/>
    </ResourcePool>
  </JDF>
</JDF>
```

8.13 BundlingParams

New in JDF 1.2

BundlingParams describes the details of a **Bundling** process.

Resource Properties

Resource Class: Parameter

Input of Processes: Bundling

Table 8.21: BundlingParams Resource

NAME	DATA TYPE	DESCRIPTION
<i>Copies</i> ?	integer	Number of copies within a bundle. @Copies SHALL NOT be specified if @Length is present.
<i>Length</i> ?	double	Length of a bundle. @Length SHALL NOT be specified if @Copies is present.

Figure 8-9: BundlingParams coordinate system

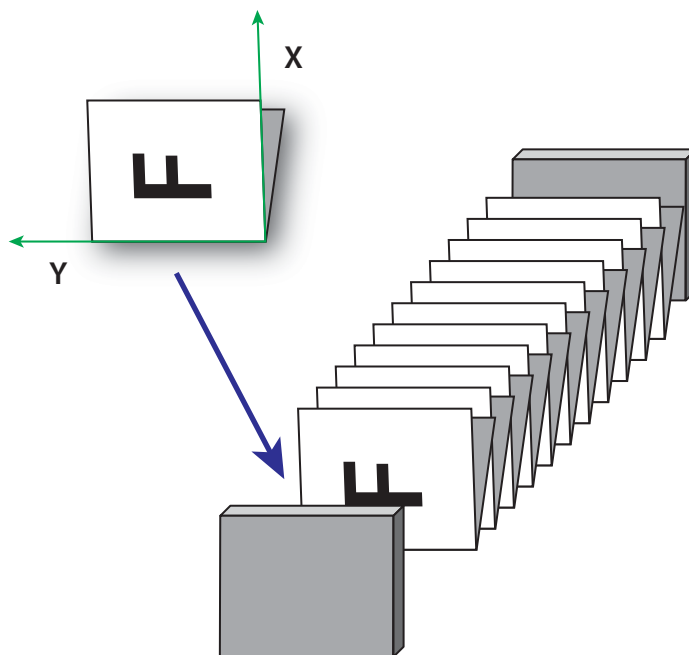

8.14 ByteMap

ByteMap specifies the structure of bytemaps produced by various processes within a JDF system. A ByteMap represents a raster of image data. This data MAY have multiple bits per pixel, MAY represent a varying set of color planes, and MAY be interleaved. A bitmap is a special case of a ByteMap in which each pixel is represented by a single bit per color.

Personalized printing requires that certain regions of a given page be dynamically replaced. The OPTIONAL mask associated with each band of data allows for omitting certain pixels from the base image represented by the ByteMap so that they can be replaced.

Resource Properties

Resource Class: Parameter

Resource references: RunList

Table 8.22: ByteMap Resource (Sheet 1 of 2)

NAME	DATA TYPE	DESCRIPTION
<i>BandOrdering</i> ?	enumeration	Identifies the precedence given when ordering the produced bands. @BandOrdering is REQUIRED for non-interleaved data and SHALL be ignored for interleaved data if specified. Allowed values are: BandMajor – The position of the bands on the page is prioritized over the color. ColorMajor – All bands of a single color are played in order before progressing to the next plane. This is only possible with non-interleaved data.

Table 8.22: ByteMap Resource (Sheet 2 of 2)

NAME	DATA TYPE	DESCRIPTION
ElementType ? New in JDF 1.4	enumeration	Allowed values are from: ▶ ElementType .
FrameHeight ? Modified in JDF 1.4	integer	Height of the overall image that MAY be broken into multiple bands. Modification note: Starting with JDF 1.4 , @FrameHeight is optional.
FrameWidth ? Modified in JDF 1.4	integer	Width of overall image that MAY be broken into multiple columns. Modification note: Starting with JDF 1.4 , @FrameWidth is optional.
Halftoned ? Modified in JDF 1.4	boolean	Indicates whether or not the data has been halftoned. Modification note: Starting with JDF 1.4 , @Halftoned is optional.
Interleaved ? Modified in JDF 1.4	boolean	If "true", the data are interleaved or chunky. Otherwise the data are non-interleaved or planar. Modification note: Starting with JDF 1.4 , @Interleaved is optional.
PixelSkip ?	integer	Number of bits to skip between pixels of interleaved data.
Resolution ? Modified in JDF 1.4	XYPair	Output resolution. Modification note: Starting with JDF 1.4 , @Resolution is optional.
Band * Modified in JDF 1.4	element	Array of bands containing raster data. Modification note: Starting with JDF 1.4 , Band is optional.
ColorPool ? New in JDF 1.2	refelement	Details of the colors represented in this ByteMap .
FileSpec (RasterFileLocation) ?	refelement	A FileSpec resource pointing to a location where the raster is stored or is be stored shortly.
PixelColorant * Modified in JDF 1.4	element	Ordered list containing information about which colorants are represented and how many bits per pixel are used. Modification note: Starting with JDF 1.4 , PixelColorant is optional.

8.14.1 Band

Table 8.23: Band Element

NAME	DATA TYPE	DESCRIPTION
Data ? Modified in JDF 1.4	URL	Actual bytes of data. Modification note: Starting with JDF 1.4 , @Data is optional.
Height ? Modified in JDF 1.4	integer	Height in pixels of the band. Modification note: Starting with JDF 1.4 , @Height is optional.
Mask ?	URL	1-bit mask of raster data indicating which bits of the band data to use. The mask dimensions and resolution SHALL be equivalent to the contents of the band itself.
WasMarked ? Modified in JDF 1.4	boolean	Indicates whether any rendering marks were made in this band. This attribute allows a band to be skipped if no marks were made in the band. Modification note: Starting with JDF 1.4 , @WasMarked is optional.
Width ? Modified in JDF 1.4	integer	Width in pixels of the band Modification note: Starting with JDF 1.4 , @Width is optional.

8.14.2 PixelColorant

Table 8.24: PixelColorant Element

NAME	DATA TYPE	DESCRIPTION
<i>ColorantName</i>	string	Name of colorant.
<i>PixelDepth</i>	integer	Number of bits per pixel for each colorant.

8.15 CaseMakingParams

New in JDF 1.1

CaseMakingParams describes the settings of a **CaseMaking** process for hardcover binding.

Resource Properties

Resource Class: Parameter

Intent Pairing: **BindingIntent**Input of Processes: **CaseMaking**

Table 8.25: CaseMakingParams Resource

NAME	DATA TYPE	DESCRIPTION
<i>BottomFoldIn</i> ?	double	Defines the width of the part of the cover material on the lower edge inside of the case. If <i>@BottomFoldIn</i> is not specified the value from <i>@TopFoldIn</i> SHALL be used.
<i>CornerType</i> ?	NMTOKEN	Method of wrapping the corners of the cover material around the corners of the board. Values include: LibraryCorner – The American Library Corner style.
<i>CoverWidth</i> ?	double	Width of the cover cardboard in points.
<i>FrontFoldIn</i> ?	double	Defines the width of the part of the cover material on the front edges inside of the case in points.
<i>Height</i> ?	double	Height of the book case, in points.
<i>JointWidth</i> ?	double	Width of the joint as seen when laying the cardboard on the cover material, in points.
<i>SpineWidth</i> ?	double	Width of the spine cardboard, in points.
<i>TopFoldIn</i> ?	double	Defines the width of the cover material on the top edge inside of the case, in points.
<i>GlueLine</i> ?	element	Details of the glue. Because the glue is applied to the whole back side of the cover material, <i>GlueLine/@AreaGlue</i> SHALL be set to "true".

RESOURCES

The following figure shows the geometry of a book case. The thickness of the cover board and spine board are defined in the input **Component**(CoverBoard) and, optionally, the input **Component**(SpineBoard) of the **CaseMaking** process.

Figure 8-10: CaseMakingParams

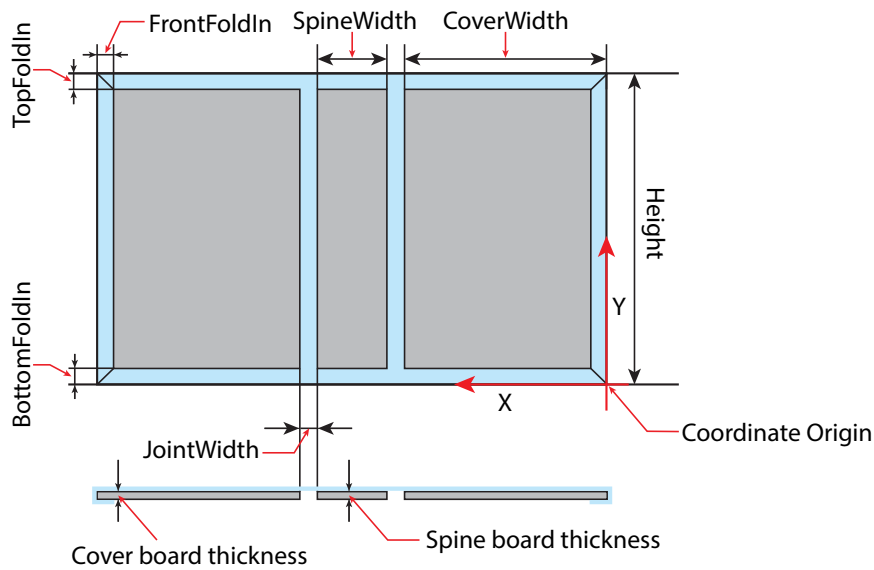

8.16 CasingInParams

New in JDF 1.1

CasingInParams describes the settings of a **CasingIn** process. The geometry SHALL always be centered. See ▶ Figure 8-11: Parameters and coordinate system for CasingIn.

Resource Properties

- Resource Class: Parameter
- Intent Pairing: **BindingIntent**
- Input of Processes: **CasingIn**

Table 8.26: CasingInParams Resource

NAME	DATA TYPE	DESCRIPTION
<i>CaseRadius</i> ?	double	Inner radius of the case spine rounding. If not specified, no rounding of the case spine is performed.
<i>CoverWidth</i> ? New in JDF 1.5	double	Width of the cover board. Note: Height and total case dimensions are specified in the Component (BookCase) of the CasingIn process. For details of @CoverWidth, see also ▶ Figure 8-10: CaseMakingParams.
<i>SpineWidth</i> ? New in JDF 1.5	double	Width of the spine board. Note: Height and total case dimensions are specified in the Component (BookCase) of the CasingIn process. For details of @SpineWidth, see also ▶ Figure 8-10: CaseMakingParams.
<i>GlueApplication</i> * New in JDF 1.4	refelement	Properties of the glue to attach the case.
<i>GlueLine</i> + Deprecated in JDF 1.4	element	Properties of the glue used. Deprecation note: Starting with JDF 1.4 , use GlueApplication .

Figure 8-11: Parameters and coordinate system for CasingIn

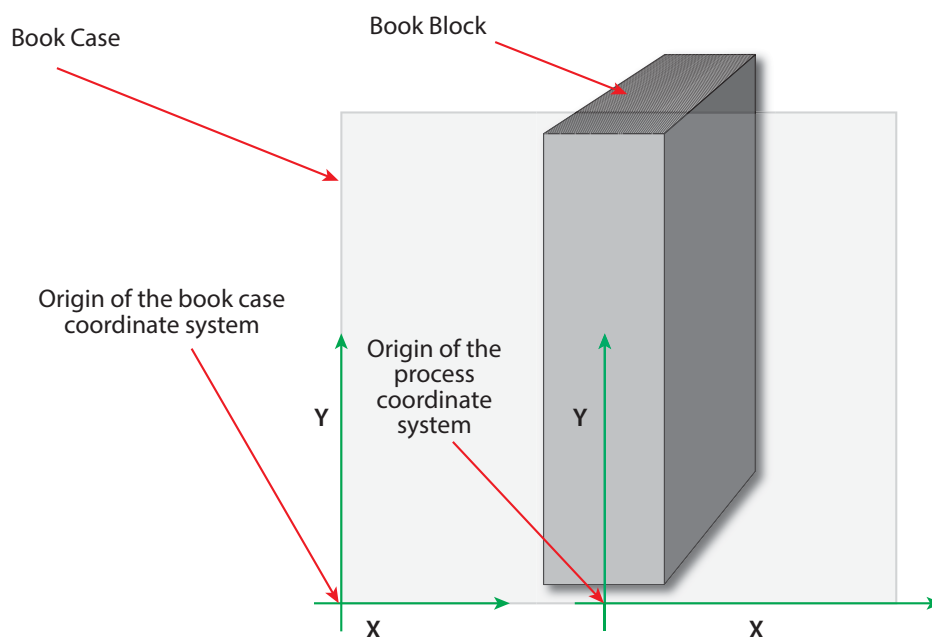

8.17 ChannelBindingParams

ChannelBindingParams describes the details of the **ChannelBinding** process.

► Figure 8-12: Parameters used for ChannelBinding depicts the **ChannelBinding** process.

The symbols W, L and ClampD of ► Figure 8-12: Parameters used for ChannelBinding are described by the attributes @ClampD and @ClampSize of the table below.

Resource Properties

Resource Class: **Parameter**
 Intent Pairing: **BindingIntent**
 Input of Processes: **ChannelBinding**

Table 8.27: ChannelBindingParams Resource

NAME	DATA TYPE	DESCRIPTION
<i>Brand</i> ?	string	The name of the clamp (or preassembled cover with clamp) manufacturer and the name of the specific item.
<i>ClampColor</i> ?	enumeration	Determines the color of the clamp/cover. If @ClampSystem="true", then the color of the cover is also meant. Values include those from: ► NamedColor.
<i>ClampColorDetails</i> ? New in JDF 1.4	string	A more specific, specialized or site-defined name for the color. If @ClampColorDetails is supplied, @ClampColor SHOULD also be supplied.
<i>ClampD</i> ?	double	The distance of the clamp that was "pressed away". See ► Figure 8-12: Parameters used for ChannelBinding.
<i>ClampSize</i> ?	shape	The shape size of the clamp. The first number of the shape data type corresponds to the clamp width W (see ► Figure 8-12: Parameters used for ChannelBinding) which is determined by the final height of the block of sheets to be bound. The second number corresponds to the length L (see ► Figure 8-12: Parameters used for ChannelBinding). The third corresponds to the spine length (not visible in ► Figure 8-12: Parameters used for ChannelBinding). The spine length is perpendicular on the paper plane.
<i>ClampSystem</i> = "false"	boolean	If "true" the clamp is inside of a preassembled cover.

Figure 8-12: Parameters used for ChannelBinding

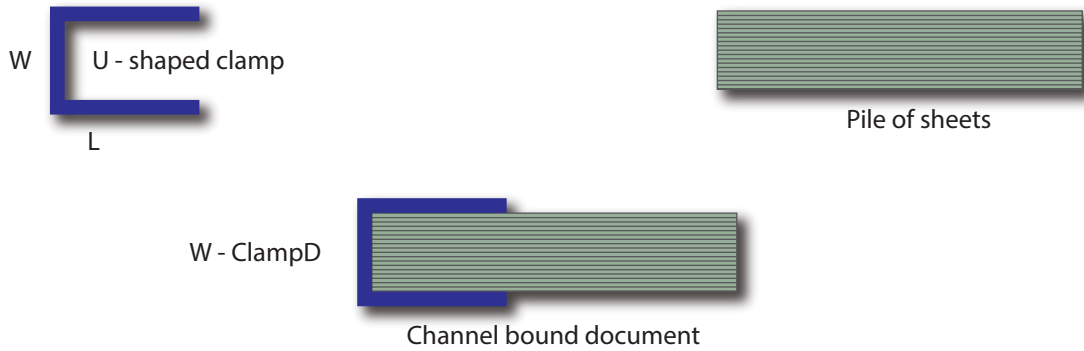

8.18 CoilBindingParams

CoilBindingParams describes the details of the **CoilBinding** process.

Resource Properties

Resource Class: **Parameter**
 Intent Pairing: **BindingIntent**
 Input of Processes: **CoilBinding**

Table 8.28: CoilBindingParams Resource

NAME	DATA TYPE	DESCRIPTION
<i>Brand</i> ?	string	The name of the coil manufacturer and the name of the specific item.
<i>Color</i> ?	enumeration	Determines the color of the coil. Allowed value is from: ▶ NamedColor.
<i>ColorDetails</i> ? New in JDF 1.4	string	A more specific, specialized or site-defined name for the color. If @ColorDetails is supplied, @Color SHOULD also be supplied.
<i>Diameter</i> ?	double	The coil diameter to be produced is determined by the height of the block of sheets to be bound.
<i>Material</i> ?	enumeration	The material used for forming the coil binding. Allowed values are: LaqueredSteel NylonCoatedSteel PVC TinnedSteel ZincsSteel
<i>Shift</i> ? Deprecated in JDF 1.2	double	Amount of vertical shift that occurs as a result of the coil action while opening the document. It is determined by the distance between the holes. In JDF 1.2 and beyond, use the value implied by HoleMakingParams / @HoleType.
<i>Thickness</i> ?	double	The thickness of the coil.
<i>Tucked</i> = "false"	boolean	If "true", the ends of the coils are "tucked in".
HoleMakingParams ? New in JDF 1.2	refelement	Details of the holes in CoilBinding .

8.19 CollectingParams

The **Collecting** process needs no special attributes. However, **CollectingParams** is provided as a container for extensions of the **Collecting** process.

Resource Properties

Resource Class: Parameter

Input of Processes: **Collecting**

Table 8.29: CollectingParams Resource

NAME	DATA TYPE	DESCRIPTION

Figure 8-13: Coordinate systems used for collecting

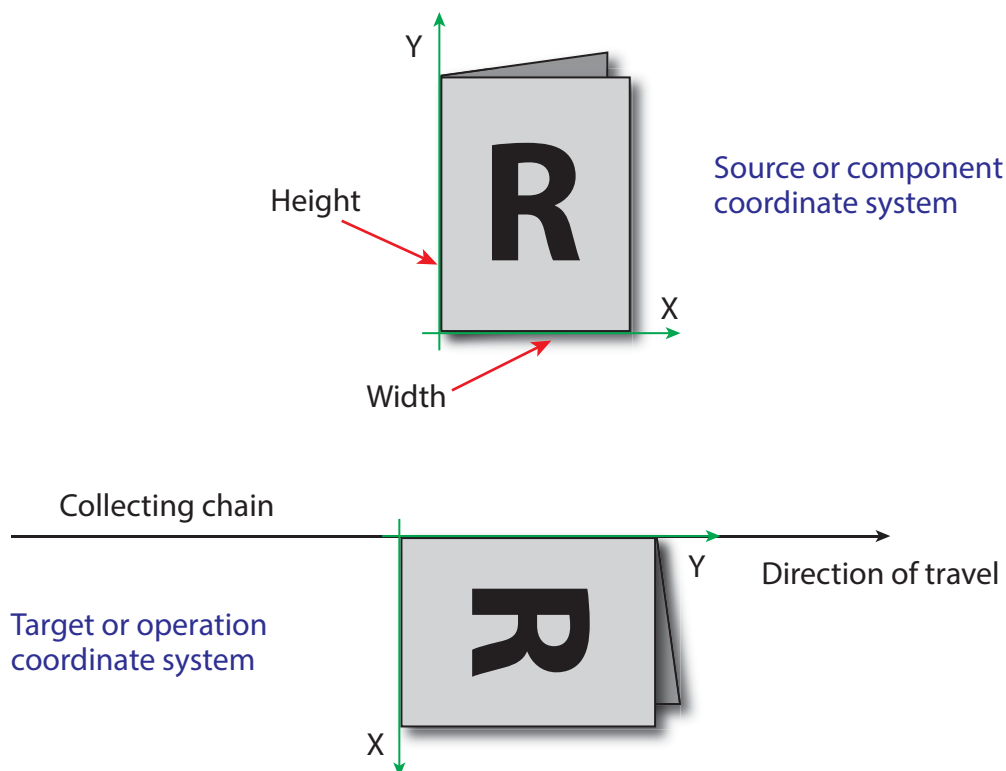

8.20 Color

Color describes the details of spot color inks, process color inks and any other coating, for instance varnish or gloss coating. Spot colors are named colors that can either be separated or converted to process colors. It is important to know the neutral density of the colorant for trapping and, in many cases, the @Lab values for representing them on screen. If you know the @Lab value, you can calculate the neutral density. When representing colors on screen, a conversion to process colors SHALL be defined. This conversion is a simple linear interpolation between the @CMYK value of the 100% spot color and its tint.

A color is represented by a **Color** element. It has a REQUIRED @Name attribute, which represents the name of either a spot color or a process color. When **ColorantAlias** has been used in **ElementColorParams** and/or in **ColorantControl** to clean up string names of spot colors, the resolved, not the uncorrected duplicate, **ColorantAlias/@ReplacementColorantName** spot color name SHALL match **Color/@Name**. The four names that are reserved for representing process CMYK color names are "Cyan", "Magenta", "Yellow" and "Black". Every colorant MAY have a @Lab and/or @CMYK color value. If both are specified and a system is capable of interpreting both values, the @Lab value overrides the @CMYK definition, unless the target device is compatible with CMYK (i.e., **ColorantControl/@ProcessColorModel="DeviceCMYK"**). In this case the CMYK value has precedence.

The @Lab value represents the L, a, b readings of the ink on certain media. This means that spot inks printed on three different kinds of stocks have different @Lab values. Pantone books, for example, provide @Lab values for three kinds of paper: "Coated" (not necessarily glossy), "Matte" and "Uncoated". Thus a color of ink SHOULD identify the media for which the color is specified. CMYK colors are used to approximate spot colors when they are not separated. This conversion can be done by a color management system, or there can be fixed CMYK representation defined by color books such as Pantone.

Resource Properties

Resource Class: Parameter

Resource referenced by: [ColorPool](#), [LayoutPreparationParams/PageCell](#)

Intent Pairing: [ColorIntent](#)

Table 8.30: Color Resource (Sheet 1 of 3)

NAME	DATA TYPE	DESCRIPTION
ActualColorName ? New in JDF 1.3	string	Actual name of the color in the PDL. @ActualColorName SHOULD be used to identify the color. If not specified, the value from @Name SHALL be used. If @ActualColorName and @Name are different, the separation SHALL be identified by the value of @Name
CMYK ? Modified in JDF 1.2	CMYKColor	CMYK value of the 100% tint value of the colorant. @CMYK SHOULD be specified if known and @ColorType != "Transparent" and @ColorType != "DieLine".
ColorBook ? Modified in JDF 1.2	string	Definition of the color identification book name that is used to represent this color. The color book name SHALL match the name defined by the color book vendor. Values include: CIP4 ColorBook Uncoated Grade 5 PANTONE C – an example PANTONE C – an example Placeholder – "Placeholder" is a special token that indicates that the Color/ @Name is not a real color but a place holder like 'Spot1' that SHALL be resolved when the content arrives. New in JDF 1.3 Modification note: Starting with JDF 1.2 , the data type changes from NMTO-KEN to string.
ColorBookEntry ? Modified in JDF 1.2	string	Definition of the Color within the standard specified by @ColorBook . This entry SHALL match the color book entry exactly as defined by the @ColorBook specified vendor, including capitalization and media type extension. When using ICC profiles, this maps to the NCL2 value of a namedColorType tag of an ICC color profile. This entry is used to map from the JDF Color to an ICC namedColorType tag.
ColorBookPrefix ?	string	Definition of the name prefix of the color book entry within a named ICC profile. This entry is used to map from the JDF Color to an ICC namedColorType tag.
ColorBookSuffix ?	string	Definition of the name suffix of the color book entry within a named ICC profile. This entry is used to map from the JDF Color to an ICC namedColorType tag.
ColorDetails ? New in JDF 1.4	string	A more specific, specialized or site-defined name for the color. If @ColorDetails is supplied, @ColorName SHOULD also be supplied.
ColorName ? New in JDF 1.1	enumeration	Mapping to a color name. Allowed value is from: ▶ NamedColor.

Table 8.30: Color Resource (Sheet 2 of 3)

NAME	DATA TYPE	DESCRIPTION
<i>ColorType</i> ? Modified in JDF 1.2	enumeration	A name that characterizes the colorant. Allowed values are: DieLine – Marks made with colorants of this type are ignored for trapping. Trapping processes need not generate a color plane for this colorant. "DieLine" can be used for auxiliary process separations. "DieLine" marks will generally appear on proof output but will not be marked on final output (e.g., plates). Note that the ColorantControl resource SHALL be correctly set up for the RIP and that @ColorType="DieLine" does not implicitly remove the "DieLine" separation from the final output. Normal – Marks made with colorants of this type, marks covered by colorants of this type, and marks on top of colorants of this type are trapped. Opaque – Marks covered by colorants of this type are ignored for trapping. "Opaque" can be used for metallic inks. OpaqueIgnore – Marks made with colorants of this type and marks covered by colorants of this type are ignored for trapping. "OpaqueIgnore" can be used for metallic inks. Primer – Colors with @ColorType="Primer" are used as background filler and SHALL be ignored when trapping. Transparent – Marks made with colorants of this type are to be ignored for trapping. Trapping processes are not to generate a color plane for this colorant. This value SHOULD be used for varnish.
<i>ColorTypeDetails</i> ? New in JDF 1.5	string	Additional information about the color type. If @ColorType="DieLine" , this attribute SHOULD specify the type of die line, e.g. DDES-numbers. See ▶ Table 8.32 Diecutting Data (DDES3) for a list of DDES3 die line types.
<i>Density</i> ? New in JDF 1.2	double	Density value of colorant (100% tint). Whereas @NeutralDensity describes measurements of inks on substrate with wide-band filter functions, @Density is derived from measurements of inks on substrate with special small-band filter functions according to ANSI and DIN.
<i>Gray</i> ? New in JDF 1.4	double	Gray value of the 100% tint value of the colorant. @Gray SHALL be specified using a subtractive color model: 0.0 means 100% coverage with colorant, while 1.0 means no coverage.
<i>Lab</i> ?	LabColor	L, a, b value of the 100% tint value of the colorant.
<i>MappingSelection</i> ? New in JDF 1.2 Modified in JDF 1.5	enumeration	This value specifies the mapping method to be used for this color. @MappingSelection can be specifically used to indicate how a combination of process colorant values will be obtained for any spot color when the separation spot colorant itself is not to be used. Allowed values is from: ▶ MappingSelection. Modification note: Starting with JDF 1.5, the schema default has been removed and the default SHOULD be obtained from ColorantControl/@MappingSelection .
<i>MediaType</i> ? Modified in JDF 1.2	string	Specifies the media type. Values include: Coated – Pertains to gloss coated. Matte – Pertains to matte or dull coated. Uncoated
<i>Name</i>	string	Name of the colorant. This is the value that SHALL match the @Name attribute of a SeparationSpec that references this color (e.g., in ColorantControl/DeviceNSpace/SeparationSpec/@Name or ColorantControl/ColorantParams/SeparationSpec/@Name). This @Name attribute MAY also be referenced from the @Name attribute in the Ink resource. Name MAY also be referenced from ColorantAlias/@ReplacementColorantName . Only one Color with any given @Name SHALL be specified in a ColorPool .
<i>NeutralDensity</i> ?	double	A number in the range of 0.001 to 10 that represents the neutral density of the colorant, defined as $10 \cdot \log(1/Y)$. Y is the tristimulus value in CIEXYZ coordinates, normalized to 1.0.

Table 8.30: Color Resource (Sheet 3 of 3)

NAME	DATA TYPE	DESCRIPTION
<i>PrintingTechnology</i> ? New in JDF 1.5	NMTOKEN	Printing technology of the press, press module or printer. For digital printing, describes the printing technology that the media or coatings on the media are intended for or optimized for. Values include those from: ▶ Printing Technologies. Creation Note: Starting in JDF 1.5, @ <i>PrintingTechnology</i> moved from <i>ConventionalPrintingParams</i> and additional values were copied from <i>Media</i> ,
<i>RawName</i> ? New in JDF 1.2	hexBinary	Representation of the original 8-bit byte stream of the <i>Color</i> / <i>@Name</i> . Used to transport the original byte representation of a <i>Color</i> / <i>@Name</i> when moving JDF tickets between computers with different locales. Only one <i>Color</i> with any given <i>@RawName</i> SHALL be specified in a <i>ColorPool</i> .
<i>sRGB</i> ?	sRGBColor	sRGB value of the 100% tint value of the colorant.
<i>UsePDALternateCS</i> ? Deprecated in JDF 1.2	boolean	If "true", the alternate color space definition defined in the PDL SHALL be used for color space transformations when available. If "false", the alternate color space definitions defined in <i>@sRGB</i> , <i>@CMYK</i> or <i>DeviceNColor</i> of this <i>Color</i> SHALL be used depending on the value of <i>ColorantControl</i> / <i>@ProcessColorModel</i> . In JDF 1.2 and beyond, use <i>@MappingSelection</i> .
<i>ColorMeasurementConditions</i> ? New in JDF 1.1	refelement	Detailed description of the measurement conditions for color measurements.
<i>DeviceNColor</i> *	element	Each <i>DeviceNColor</i> element defines the colorant in the DeviceN color space that is defined by <i>DeviceNColor</i> / <i>@Name</i> .
<i>FileSpec</i> (<i>ColorProfile</i>) ?	refelement	A <i>FileSpec</i> resource pointing to an ICC named color profile that describes further details of the color. This ICC profile is intended as a source profile for the named color whose equivalent CMYK value is given in the <i>@CMYK</i> attribute.
<i>FileSpec</i> (<i>TargetProfile</i>) ?	refelement	A <i>FileSpec</i> resource pointing to an ICC profile that defines the target output device in case the object that uses the <i>Color</i> has been color space converted to a device color space. <i>FileSpec</i> (<i>TargetProfile</i>) applies to the alternate color defined by the value of <i>@MappingSelection</i> .
<i>PrintConditionColor</i> * New in JDF 1.2	element	Description of the printing condition specific color properties of a colorant (i.e., how is the printed color result specific to media, screening, etc.).
<i>TransferCurve</i> * Modified in JDF 1.1	refelement	A list of color transfer functions that is used to convert a tint value to one of the alternative color spaces. The transfer functions that are not specified here default to a linear transfer: "0 0 1 1".

8.20.1 DeviceNColor

Table 8.31: DeviceNColor Element

NAME	DATA TYPE	DESCRIPTION
<i>ColorList</i>	DoubleList	Value of the 100% tint value of the colorant in the ordered DeviceN space. The list SHALL have <i>@N</i> elements. A value of 0 SHALL specify no ink and a value of 1 SHALL specify full ink. The mapping of indices to colors is specified in the <i>DeviceNSpace</i> element of the <i>ColorantControl</i> resource.
<i>N</i>	integer	Number of colors that define the color space.
<i>Name</i>	string	Color space name (e.g., HexaChrome or HiFi). <i>@Name</i> SHALL match <i>ColorantControl</i> / <i>DeviceNSpace</i> / <i>@Name</i> .

8.20.2 Diecutting Data (DDES3)

The following list of line types is taken from Annex A of ANSI® IT8.6-2002 Graphic Technology — Prepress Digital Data Exchange — Diecutting data ▶ [DDES3]. The list is included in the **JDF** specification with permission of IT8.6.

Table 8.32: Diecutting Data (DDES3)

DDES3 LINE TYPE NUMBER	DDES3 LINE TYPE	DESCRIPTION
12	Non-varnish / UV area	Contour indicating a varnish free area.
15	Printing / UV Blanket Edge	Contour enclosing a spot varnish area. Spot varnish will be applied with a varnish blanket.
16	Zipper / Tear Strip / Tear Edge (reference lines for cutting edge)	Cutting contours indicating a tear strip.
17	Wave / Scallop (reference lines for cutting edge)	Cutting contours indicating a wave /scallop.
18	Punches (reference lines for center / cutting edge)	Contours indicating the shape and center of a punch.
100	Miscellaneous ruled lines for dies	
101	Knife / Cutting rule	Contour indicating how the printed artwork will be cut from the printed sheet, e.g. with a guillotine cutter or die cutting device.
102	Crease / Scoring rule	Contour indicating where the substrate will be creased to guide subsequent folding.
103	Perforation (Alternating cutting and spaces)	Contour indicating where the substrate will be perforated.
104	Cutscore / Halfcut (Partial depth cutting rule)	Contour indicating where the substrate will be cut partially, i.e. not entirely through the material. Cutting is done from the front side.
105	Cut-Crease rule (Alternating cutting and creasing rule)	Contour indicating alternating cutting and creasing.
106	Cutscore-Crease (Alternating partial depth cutting and creasing rule)	Contour indicating alternating half-cutting and creasing.
107	Reverse cutscore / halfcut (for anvil in die)	Contour indicating where the substrate will be cut partially, i.e. not entirely through the material. Cutting is done from the back side.
108	Emboss / Deboss crease profile	Contour enclosing an area where embossing will be applied.

8.20.3 PrintConditionColor

New in JDF 1.2

The **Color** element describes the specific properties of a colorant (named in **Color/@Name**) when applied in a given printing condition (i.e., media surface, media opacity, media color and screening/RIP (e.g., halftone) technology). It is used to overwrite the generic values of **Color**, which are supplied as the default. See the descriptions in color for details of the individual attributes and elements.

Table 8.33: PrintConditionColor Element (Sheet 1 of 2)

NAME	DATA TYPE	DESCRIPTION
CMYK ?	CMYKColor	@CMYK of the Color . Default value is from: parent Color /@CMYK

Table 8.33: PrintConditionColor Element (Sheet 2 of 2)

NAME	DATA TYPE	DESCRIPTION
<i>ColorBook</i> ?	string	@ <i>ColorBook</i> of the <i>Color</i> . Default value is from: parent <i>Color</i> / <i>@ColorBook</i>
<i>ColorBookEntry</i> ?	string	@ <i>ColorBookEntry</i> of the <i>Color</i> . Default value is from: parent <i>Color</i> / <i>@ColorBookEntry</i>
<i>ColorBookPrefix</i> ?	string	@ <i>ColorBookPrefix</i> of the <i>Color</i> . Default value is from: parent <i>Color</i> / <i>@ColorBookPrefix</i>
<i>ColorBookSuffix</i> ?	string	@ <i>ColorBookSuffix</i> of the <i>Color</i> . Default value is from: parent <i>Color</i> / <i>@ColorBookSuffix</i>
<i>Density</i> ?	double	@ <i>Density</i> of the <i>Color</i> . Default value is from: parent <i>Color</i> / <i>@Density</i>
<i>Lab</i> ?	LabColor	@ <i>Lab</i> of the <i>Color</i> . Default value is from: parent <i>Color</i> / <i>@Lab</i>
<i>MappingSelection</i> ? New in JDF 1.2	enumeration	This value specified the mapping method to be used for this color. Default value is from: parent <i>Color</i> / <i>@MappingSelection</i> . Allowed value is from: ▶ MappingSelection.
<i>MediaSide</i> ="Both"	enumeration	<i>Media</i> front and back surfaces can be different, affecting color results. If the <i>Media</i> / <i>@FrontCoatings</i> , <i>Media</i> / <i>@BackCoatings</i> or <i>Media</i> / <i>@Gloss</i> attributes indicate differences in surface then <i>@MediaSide</i> can be used to specify the side of the media to which the <i>Color</i> attributes pertain. Allowed values are: Front Back Both
<i>NeutralDensity</i> ?	double	@ <i>NeutralDensity</i> of the <i>Color</i> . Default value is from: parent <i>Color</i> / <i>@NeutralDensity</i>
<i>PrintConditionName</i> ?	NMTOKEN	@ <i>PrintConditionName</i> specifies a characterization data set that is applied to a specific setup including paper selection and screening setup. See <i>PrintCondition</i> for details of characterization data sets
<i>sRGB</i> ?	sRGBColor	@ <i>sRGB</i> of the <i>Color</i> . If not specified, defaults to the parent <i>Color</i> / <i>@sRGB</i> .
<i>DeviceNColor</i> *	element	<i>DeviceNColor</i> of the <i>Color</i> . If not specified, defaults to the parent <i>Color</i> / <i>DeviceNColor</i> .
<i>FileSpec</i>	refelement	<i>FileSpec</i> (<i>TargetProfile</i>) of the <i>Color</i> . If not specified, defaults to the parent <i>Color</i> / <i>FileSpec</i> (<i>TargetProfile</i>)
<i>Media</i> *	refelement	Specifies one or more <i>Media</i> that this <i>Color</i> applies to. When <i>PrintConditionColor</i> is present, the parent attribute, <i>Color</i> / <i>@MediaType</i> , is ignored. If <i>Media</i> is not specified, <i>Color</i> applies to print processes with a matching <i>@PrintConditionName</i> .
<i>TransferCurve</i> *	refelement	<i>TransferCurve</i> of the <i>Color</i> . If not specified, defaults to the parent <i>Color</i> / <i>TransferCurve</i> .

Example 8.10: Color

This is an example of the structure for **Color**. The transfer curves in this example are defined for process CMYK and sRGB, independently.

```
<Color CMYK="0.2 0.3 0.4 0.5" Class="Parameter" Density="3.14"
  ID="C000" Lab="20. 30. 40." MediaType="Coated"
  Name="PANTONE Deep Blue" Status="Available" sRGB="0.6 0.7 0.9">
  <TransferCurve Curve="0 0 .5 .4 1 1" Separation="Cyan"/>
  <TransferCurve Curve="0 0 .5 .6 1 1" Separation="Magenta"/>
  <TransferCurve Curve="0 0 1 1" Separation="Yellow"/>
  <TransferCurve Curve="0 0 1 1" Separation="Black"/>
  <TransferCurve Curve="0 0 1 1" Separation="sRed"/>
  <TransferCurve Curve="0 0 1 1" Separation="sGreen"/>
  <TransferCurve Curve="0 0 1 1" Separation="sBlue"/>
</Color>
```

Example 8.11: ColorantControl: Content-Ignorant MIS

New in JDF 1.4

```
<ColorantControl Class="Parameter" ID="r000004"
  ProcessColorModel="DeviceCMYK" Status="Available">
  <!--Note that all Strings in ColorantParams etc. use Color/@Name,
    NOT Color/@ActualColorName-->
  <ColorantParams>
    <SeparationSpec Name="Spot1"/>
    <SeparationSpec Name="BlackText"/>
  </ColorantParams>
</ColorantControl>
```

Example 8.12: ColorantControl: Synchronized with Input

New in JDF 1.4

Example of initial (previous) **ColorantControl** after synchronizing with input. This example specifies the replacement color name with a new **@ActualColorName** attribute in the **Color** element. This approach has the disadvantage of needing a new attribute. However, it has the following advantages:

- no ambiguity in case of multiple names (**ColorantAlias** is used only as a pure aliasing mechanism)
- The name is localized in the **ColorPool**, which should be more central and not differ (e.g., between proofing and final imaging).

RESOURCES

- it is “easier” to implement

```
<!--ColorantControl after prepress has correctly set ActualColorName based
on pdl content-->
<ColorantControl Class="Parameter" ID="r000004"
  ProcessColorModel="DeviceCMYK" Status="Available">
  <!--Note that all Strings in ColorantParams etc. use Color/@Name,
  NOT Color/@ActualColorName-->
  <ColorantParams>
    <SeparationSpec Name="Spot1"/>
    <SeparationSpec Name="BlackText"/>
  </ColorantParams>
  <ColorPoolRef rRef="r000005"/>
</ColorantControl>
<ColorPool Class="Parameter" ID="r000005" Status="Available">
  <!--Color that maps the predefined separation Black
  ActualColorName is the new attribute that replaces
  ExposedMedia/@DescriptiveName as the "Main" PDL color-->
  <Color ActualColorName="Schwarz" CMYK="0 0 0 1" Class="Parameter" Name="Black"/>
  <Color ActualColorName="Gelb" CMYK="0 0 1 0" Class="Parameter" Name="Yellow"/>
  <!--ActualColorName defaults to Name if not specified-->
  <Color CMYK="1 0 0 0" Class="Parameter" Name="Cyan"/>
  <Color Class="Parameter" Name="Magenta"/>
  <Color ActualColorName="Acme Aqua" CMYK="0.7 0.2 0.03 0.1"
    Class="Parameter" Name="Spot1"/>
  <Color ActualColorName="VersionsText" CMYK="0 0 0 1"
    Class="Parameter" Name="BlackText"/>
</ColorPool>
```

Example 8.13: ColorantControl: Synchronized with Input with Alias

New in JDF 1.4

Example of initial **ColorantControl** after synchronizing with input that contains an alias.

```
<ColorantControl Class="Parameter" ID="r000004"
  ProcessColorModel="DeviceCMYK" Status="Available">
  <!--ColorantControl after prepress has correctly set ActualColorName based
  on pdl content-->
  <!--Note that all Strings in ColorantParams etc. use Color/@Name,
  NOT Color/@ActualColorName-->
  <ColorantParams>
    <SeparationSpec Name="Spot1"/>
    <SeparationSpec Name="BlackText"/>
  </ColorantParams>
  <ColorPoolRef rRef="r000005"/>
  <!--ColorantAlias that maps the additional representations
  (
    noir, schwarz) to the predefined separation Black-->
  <ColorantAlias Class="Parameter"
    RawNames="6E6F6972 73636877E4727A" ReplacementColorantName="Black">
    <SeparationSpec Name="noir"/>
    <SeparationSpec Name="schwarz"/>
  </ColorantAlias>
</ColorantControl>
<ColorPool Class="Parameter" ID="r000005" Status="Available">
  <!-- ColorPool is same as previous example -->
</ColorPool>
```

8.21 ColorantControl

ColorantControl is a resource used to control the use of color when processing PDL pages. The attributes and elements of the **ColorantControl** resource describe how color information embedded in PDL pages SHALL be translated into device colorant information.

Colorants are referenced in **ColorantControl** by name only. Additional details about individual colorants can be found in the **Color** element of the **ColorPool** resource. **ColorantControl** uses the subset of colors specified in **@ColorantConvertProcess**. The **ColorantControl** resources control which device colorants will be used, as well as how document colors will be converted into device color spaces; and how conflicting color information are to be resolved. Separation control is specified by the process being present. For example:

ColorantControl can be used as follows to define the specific colorants of a targeted output **DeviceNSpace** when the **DeviceNSpace** process colors are the only colorants used on the job:

- **ColorantControl/ColorPool/@ColorantSetName** matches **ColorantControl/DeviceNSpace/@Name**, and
- a **ColorantControl/ColorPool/Color** resource (with correct **@Name** of colorant and other defining attributes) exists for each colorant of the **DeviceNSpace** as given in:
 - **ColorantControl/DeviceNSpace/SeparationSpec/@Name**.

ColorantControl can be used as follows to define the specific colorants of a targeted output when both CMYK process colors and separate spot colorants are used for the final production printing, but a local printer equivalent of the spot color is used for proofing:

- **ColorPool/@ColorantSetName** is an expanded name set including **Color** resources for the CMYK process primaries and the **@ReplacementColorantName** spot colorant, and
- Then for that spot color...
 - **ColorPool/Color/@Name**
 - **ColorPool/Color/@MappingSelection** attribute value="UseLocalPrinterValues", (used by a **ColorSpaceConversion** process only in the proofing instance).
- For proof printing:
 - **ColorantControl/@ColorantParams** does not list that spot colorant.
- For production printing:
 - **ColorantControl/@ColorantParams** and **ColorantControl/@ColorantOrder** both include that spot colorant.

Resource Properties

Resource Class:	Parameter
Intent Pairing:	ColorIntent
Example Partition:	"DocIndex", "RunIndex", "RunTags", "DocTags", "PageTags", "SetTags", "SheetName", "Side", "SignatureName"
Input of Processes	ColorCorrection, ColorSpaceConversion, ConventionalPrinting, DigitalPrinting, ImageSetting, Interpreting, PreviewGeneration, Separation, Stripping, Trapping
Output of Processes:	ColorSpaceConversion

Table 8.34: ColorantControl Resource (Sheet 1 of 3)

NAME	DATA TYPE	DESCRIPTION
<i>ForceSeparations</i> = "false"	boolean	If "true", forces all colorants to be output as individual separations, regardless of any values defined in ColorantControl (i.e., all separations in a document are assumed to be valid and are output individually). A value of "false" specifies to respect the parameters specified in ColorantControl and elsewhere in the JDF .
<i>InternalColorModel</i> ? New in JDF 1.5	enumeration	Internal color model that SHALL be used by a device that supports enhanced color models. Allowed values are: Basic – Use the basic color model selected by this ColorantControl . Enhanced – Use the enhanced color model that is implied by this ColorantControl (e.g., Use "LightCyan", "LightMagenta" in addition to CMYK). Explicit – Use the elements of the enhanced color model that are explicitly listed in ColorantOrder .
<i>MappingSelection</i> ? New in JDF 1.5	enumeration	This value specifies the default mapping method to be used for all separations. Note that @MappingSelection MAY be overridden by Color/@MappingSelection . @MappingSelection can be specifically used to indicate how a combination of process colorant values SHALL be obtained for any spot color when the separation spot colorant itself is not to be used. Allowed value is from: ▶ MappingSelection.

Table 8.34: ColorantControl Resource (Sheet 2 of 3)

NAME	DATA TYPE	DESCRIPTION
<p><i>ProcessColorModel</i> ? Modified in JDF 1.4</p>	<p>NMTOKEN</p>	<p>Specifies the model to be used for rendering the colorants defined in color spaces into process colorants.</p> <p>Values include:</p> <p>DeviceCMY – Process colors SHALL be Cyan Magenta and Yellow.</p> <p>DeviceCMYK – Process colors SHALL be Cyan Magenta Yellow and Black.</p> <p>DeviceGray – Process color SHALL be Black.</p> <p>DeviceN – The specific DeviceN color space to operate on is defined in the DeviceNSpace resource. If this value is specified then DeviceNSpace SHALL also be present.</p> <p>DeviceRGB – Process colors SHALL be Red Green and Blue.</p> <p>None – No colorants other than those specified in ColorantParams SHALL be output. New in JDF 1.4</p>
<p><i>ColorantAlias</i> *</p>	<p>element</p>	<p>Identify one or more named colorants that are to be replaced with a specified named colorant. The identified colorant remappings in this ColorantAlias MAY be consolidated for processing from the information received in the LayoutElement/ElementColorParams/ColorantAlias resources with the job content.</p> <p>Multiple ColorantAlias elements with identical values of ColorantAlias/@ReplacementColorantName SHALL NOT be specified in the same ColorantControl resource context.</p>
<p><i>ColorantConvertProcess</i> ? New in JDF 1.4</p>	<p>element</p>	<p>List of colors that SHALL be converted to process colors. Defaults to all colors that are neither listed in ColorantParams nor implied by @ProcessColorModel. Application can issue a warning for all PDL colors that are not in (ColorantParams + ColorantConvertProcess + implied by @ProcessColorModel) lists.</p>
<p><i>ColorantOrder</i> ?</p>	<p>element</p>	<p>The ordering of named colorants to be processed, for example in the RIP. All of the colorants named SHALL either occur in the ColorantParams list or be implied by the @ProcessColorModel.</p> <p>If present, then only the colorants specified by ColorantOrder SHALL be output. Colorants listed in the ColorantParams, or implied by the @ProcessColorModel, but not listed in ColorantOrder, SHALL NOT be output. They SHALL still be processed for side effects in the colorants that are listed such as knockouts or trapping.</p> <p>If not present, then all colorants specified in ColorantParams and implied by @ProcessColorModel are output. The explicit or implied value of ColorantOrder MAY be modified by an implied partition of the ColorantControlLink. If one or more ColorantControlLink/Part/@Separation are specified, ColorantOrder is reduced to the list. It is an error to specify values of ColorantControlLink/Part/@Separation that are not explicitly stated or implied by ColorantOrder.</p>
<p><i>ColorantParams</i> ?</p>	<p>element</p>	<p>A set of named colorants. This list defines all the colorants that are expected to be available on the device where the process will be executed. Named colors found in the PDL that are not listed in ColorantParams will be implemented through their @ProcessColorModel equivalents. (See ElementColorParams and ColorSpaceConversion process.) The colorants implied by the value of @ProcessColorModel are assumed and SHALL NOT be specified in this list. The spot colors defined in Colorintent/ColorsUsed will in general be mapped to ColorantParams for each spot color to be used as part of any product intent to process conversion.</p>

Table 8.34: ColorantControl Resource (Sheet 3 of 3)

NAME	DATA TYPE	DESCRIPTION
ColorPool ?	refelement	Pool of Color elements that define the specifics of the colors implied by @ProcessColorModel and named in ColorantControl . ColorantControl uses a subset of the total ColorPool . The subset that ColorantControl uses from ColorPool is the subset of @ProcessColorModel colors (possibly all), and the subset of spot colors (possibly all) designated to be processed in this instance using specific separation colorants. ColorPool in total includes spot colors in the job for which a JDF process color equivalent mapping is required. Those colors are used by ColorSpaceConversion when ColorPool/Color/ @MappingSelection="UseProcessColorValues" . In that case, the process color equivalent for the spot color is taken from the available information in the Color resource for that spot color.
ColorSpaceSubstitute *	element	Each subelement identifies a colorant that SHALL be replaced by another colorant.
DeviceColorantOrder ?	element	The ordering of named colorants (e.g., order of laying them down) to be output on the device, such as press modules. Note that this SHALL be synchronized with the device output ICC profile. All of the named colorants SHALL occur in ColorantOrder if it is present. If ColorantOrder is not present, then all of the named colorants SHALL occur in the ColorantParams list, or be implied by the @ProcessColorModel . If the DeviceColorantOrder element is not specified, the order for laying down colorants defaults to ColorantOrder .
DeviceNSpace * Modified in JDF 1.5	element	DeviceNSpace defines the colorants that make up a DeviceN color space. DeviceNSpace SHALL be present if the @ProcessColorModel value is "DeviceN". Modification note: Starting with JDF 1.5, the data type changes from reelement to element.

8.21.1 ColorantConvertProcess

New in JDF 1.4.

Table 8.35: ColorantConvertProcess Element

NAME	DATA TYPE	DESCRIPTION
SeparationSpec *	element	The names of the colorants that define the respective lists.

8.21.2 ColorantOrder

Table 8.36: ColorantOrder Element

NAME	DATA TYPE	DESCRIPTION
SeparationSpec *	element	The names of the colorants that define the respective lists.

8.21.3 ColorantParams

Table 8.37: ColorantParams Element

NAME	DATA TYPE	DESCRIPTION
SeparationSpec *	element	The names of the colorants that define the respective lists.

8.21.4 ColorSpaceSubstitute

Table 8.38: ColorSpaceSubstitute Element

NAME	DATA TYPE	DESCRIPTION
PDLResourceAlias	reference	A reference to a color space description that replaces the color space defined by the colorants described by the SeparationSpec element(s).
SeparationSpec + Modified in JDF 1.2	element	A list of names that defines the colorants to be replaced. This could be a single name in the case of a @Separation color space, or more than one name in the case of a DeviceN color space.

The following table describes which separations are output for various values of [@ProcessColorModel](#), [ColorantOrder](#), [ColorantControlLink](#), [ColorantParams](#) and [DeviceColorantOrder](#). Note that all separations that are neither specified in [ColorantParams](#) nor implied by [@ProcessColorModel](#) are mapped to the colors implied by [@ProcessColorModel](#) prior to any color selection defined by [ColorantOrder](#).

Table 8.39: Sample output for different values of ProcessColorModel, ColorantParams, ColorantOrder, ColorantControlLink and DeviceColorantOrder Elements.

PROCESSCOLORMODEL	COLORANTPARAMS	COLORANTORDER	COLORANTCONTROLLINK / PART/@SEPARATION	COLORANTS NOT SHOWN IN THE OUTPUT	SEPARATIONS THAT ARE OUTPUT AND ORDERED FOR PRESS USING DEVICECOLORANTORDER
DeviceCMYK	Not Present	Cyan Magenta	—	Yellow Black	Cyan Magenta (If DeviceColorantOrder is not present then lay down order will be Cyan first, Magenta last.)
DeviceCMYK	Spot1 Spot2	Cyan Magenta Yellow Black Spot2	—	Spot1	Cyan Magenta Yellow Black Spot2
DeviceCMYK	Spot1 Spot2	Cyan Magenta Yellow Black Spot2	Cyan Magenta	Spot1 Spot2 Yellow Black	Cyan Magenta
DeviceGray	Spot1 Spot2	Black Spot2	—	Spot1	Black Spot2
DeviceN (with example N = 2 colorants as identified in DeviceNSpace)	Spot1 Spot2	Spot2 DeviceN 1 DeviceN 2	—	Spot1	DeviceN 1 DeviceN 2 Spot2 The reordering is accomplished using DeviceColorantOrder .

8.21.5 DeviceColorantOrder

Table 8.40: DeviceColorantOrder Element

NAME	DATA TYPE	DESCRIPTION
SeparationSpec *	element	The names of the colorants that define the respective lists.

8.22 ColorCorrectionParams

[ColorCorrectionParams](#) provides the information needed to algorithmically correct colors on some PDL pages or content elements such as image, graphics or formatted text.

The preferred color adjustment method allows for multi-dimensional adjustments through the use of either an ICC Abstract profile or an ICC DeviceLink profile. The adjustments are not universally colorimetrically calibrated. However, when either of the ICC profile adjustment methods are used, these standard ICC profile formats can be interpreted and applied using generally recognized ICC profile processing techniques. Use of the ICC Abstract profile adjustment will cause the adjustment to be applied in ICC Profile Connection Space, after each source profile is applied, in sequence before final target color conversion. Use of the ICC DeviceLink profile adjustment will cause the adjustment to be applied in final target device space, after the final target color conversion.

In addition to color adjustment using an ICC profile, the [@AdjustXXX](#) attributes each provide a direct color adjustment applied to the interpretation of the PDL data at an implementation dependent point in the processing after each source profile is applied (if source-to-destination color conversion is needed). The L*a*b* values range from -100 to +100 to indicate the minimum and maximum of the range that the system supports. A "0" value means no adjustment. The color adjustment attributes differ from the Tone Reproduction Curve (TRC) attributes that can be applied later in the processing path in two key ways. First, the [@AdjustXXX](#) use, even when included in the job, will vary as a function of job content. Second, the data values associated with the [@AdjustXXX](#) attributes are arbitrary, and their interpretation will be printer dependent. For details about these attributes, see [Appendix D Color Adjustment](#).

Note: These color adjustments are not available in any [Intent Resource](#) (e.g., [ColorIntent](#)). In order to request such adjustment in a product intent job ticket supplied to a print provider, attach to a product intent node an incomplete [ColorCorrection](#) process with a [ColorCorrectionParams](#) resource specifying the requested [@AdjustXXX](#) attributes.

Resource Properties

Resource Class: Parameter

Intent Pairing: [ColorIntent](#)

Example Partition: "DocIndex", "RunIndex", "RunTags", "DocTags", "PageTags", "SetTags", "SheetName", "Side", "SignatureName"

Input of Processes: [ColorCorrection](#)

Table 8.41: ColorCorrectionParams Resource

NAME	DATA TYPE	DESCRIPTION
ColorManagementSystem ?	string	Identifies the preferred ICC color-management system to use when performing color transformations. When specified, this attribute overrides any default selection of a color management system by an application and overrides the "CMM Type" value (bytes 4-7 of an ICC Profile Header) in any of the job related ICC profiles. This string attribute value identifies the manufacturer of the preferred CMM and SHALL match one of the registered four-character ICC CMM type values. Values include those from: <i>ICC Manufacturer's Signature Registry</i> , see [ICC.1] . Example values: "ADBE" for the Adobe CMM and "KODA" for the Kodak CMM.
ColorCorrectionOp *	element	List of ColorCorrectionOp subelements. ColorCorrectionOp SHOULD contain the complete set of parameters for a given color correction operation. Otherwise the results are implementation dependent.
FileSpec ?	refelement	A FileSpec resource pointing to an ICC profile that describes the characterization of the final output target device.
FileSpec (WorkingColorSpace) ? Deprecated in JDF 1.1	refelement	A FileSpec resource pointing to an ICC profile that describes the assumed characterization of "CMYK", "RGB" and "Gray" color spaces.

8.23 ColorPool

The **ColorPool** resource contains a pool of all **Color** elements referred to in the job. In general, it will be referenced as a **ResourceRef** from within resources that require access to color information.

Resource Properties

Resource Class: Parameter

Resource referenced by: **ColorIntent**, **NumberingIntent**, **ByteMap**, **ColorantControl**, **FormatConversionParams**, **LayoutElement**, **PageList**, **ShapeDef**

Intent Pairing: **ColorIntent**

Input of Processes: **Any Process**

Table 8.42: ColorPool Resource

NAME	DATA TYPE	DESCRIPTION
<i>ColorantSetName</i> ?	string	A string used to identify the named colorant parameter set. This string will be used to identify a set of color definitions (typically associated with a particular class of job or a particular press). Note: This value will typically be identical to ColorIntent / <i>@ICColorStandard</i> or ColorIntent / <i>@ColorStandard</i> .
Color *	element	Individual named color.

8.24 ColorSpaceConversionParams

This set of parameters defines the rules for a **ColorSpaceConversion** process, the elements of which define the set of operations to be performed. Information inside the **ColorSpaceConversionOp** elements define the operation and identifies the color spaces and types of objects to operate on. Other attributes define the color management system to use, as well as the working color space and the final target device.

Resource Properties

Resource Class: Parameter

Intent Pairing: **ColorIntent**, **ProofingIntent**

Example Partition: "DocIndex", "RunIndex", "RunTags", "DocTags", "PageTags", "SetTags", "SheetName", "Side", "SignatureName"

Input of Processes: **ColorSpaceConversion**

Table 8.43: ColorSpaceConversionParams Resource (Sheet 1 of 2)

NAME	DATA TYPE	DESCRIPTION
<i>ColorManagementSystem</i> ?	string	Identifies the preferred ICC color management system to use when performing color transformations. When specified, this attribute overrides any default selection of a color management system by an application and overrides the "CMM Type" value (bytes 4-7 of an ICC Profile Header) in any of the job related ICC profiles. This string attribute Value identifies the manufacturer of the preferred CMM and SHALL match one of the registered four-character ICC CMM Type values. Values include those from: ICC Manufacturer's Signature Registry, see ▶ [ICC.1]. Example values: "ADBE" for the Adobe CMM and "KODA" for the Kodak CMM.
<i>ConvertDevIndepColors</i> ? Deprecated in JDF 1.1	boolean	When "true", incoming device-independent colors are processed to the selected device space. If the chosen operation is "Untag" and the characterization data are in the form of an ICC profile, then the profile is removed. Otherwise, these colors are left untouched. The functionality of <i>@ConvertDevIndepColors</i> is superseded by including one or more ColorSpaceConversionOp with <i>@SourceCS="DevIndep"</i> in JDF 1.1.

Table 8.43: ColorSpaceConversionParams Resource (Sheet 2 of 2)

NAME	DATA TYPE	DESCRIPTION
ICCProfileUsage = "UsePDL" New in JDF 1.2	enumeration	<p>@ICCProfileUsage specifies where to obtain either the destination profile or device link transform that SHALL be applied.</p> <p>Note: Use of a final target device profile provides a profiled destination to be used when converting a source object through PCS (Profiled Connection Space) to that profiled destination, and a device link transform specifies a conversion of the source object from the source space directly to the destination.</p> <p>Note: PDF/X workflows assume that @ICCProfileUsage="UsePDL".</p> <p>Allowed values are:</p> <p>UsePDL – If present, the embedded target profile SHALL be used.</p> <p>UseSupplied – The embedded target profile SHALL NOT be used.</p>
ColorSpaceConversionOp *	element	<p>List of ColorSpaceConversionOp elements, each of which identifies a type of object, defines the source color space for that type of object, and specifies the behavior of the conversion operation for that type of object. The XML order of ColorSpaceConversionOp elements is significant, and when multiple elements apply to the same object, they are applied in that XML order.</p> <p>A ColorSpaceConversionOp can modify the characteristics of an object such that its selection criteria is also modified. Thus, if two ColorSpaceConversionOp elements select the same set of objects, and the first element changes the object in such a way that the object would no longer be selected by the second element, then the second ColorSpaceConversionOp SHALL NOT be applied to that object.</p> <p>ColorSpaceConversionOp SHOULD contain the complete set of parameters for a given color space conversion operation. Otherwise the results are implementation dependent.</p> <p>A ColorSpaceConversionOp process included as part of a raster image processing combined process shall include an implied convert operation as its last operation (causing all other unconverted color spaces to be converted according to the raster image processor's PDL).</p>
FileSpec (FinalTargetDevice) ?	referencelement	<p>A FileSpec resource pointing to an ICC profile that describes the characterization of the final output target device.</p>
FileSpec (WorkingColorSpace))? Deprecated in JDF 1.1	referencelement	<p>A FileSpec resource pointing to an ICC profile that describes the assumed characterization of "CMYK", "RGB" and "Gray" color spaces.</p>

8.25 Component

Component is used to describe the various versions of semi-finished goods in the press and postpress area, such as a pile of folded sheets that have been collected and are then to be joined and trimmed. Nearly every postpress process has a **Component** resource as an input as well as an output. Typically the first components in the process chain are some printed sheets or ribbons, while the last **Component** is a book or a brochure.

Glossary – Component

The descriptions of **Component** specific attributes use some terms whose meaning depends on the culture in which they are used. For example, different cultures mean different things when they refer to the "front" side of a magazine. Other terms (e.g., binding) are defined by the production process and, therefore, do not depend on the culture.

RESOURCES

Whenever possible, this specification endeavors to use culturally independent terms. In cases where this is not possible, western style (left-to-right writing) is assumed. Please note that these terms might have a different meaning in other cultures (i.e., those writing from right to left).

Figure 8-14: Component – terms and definitions

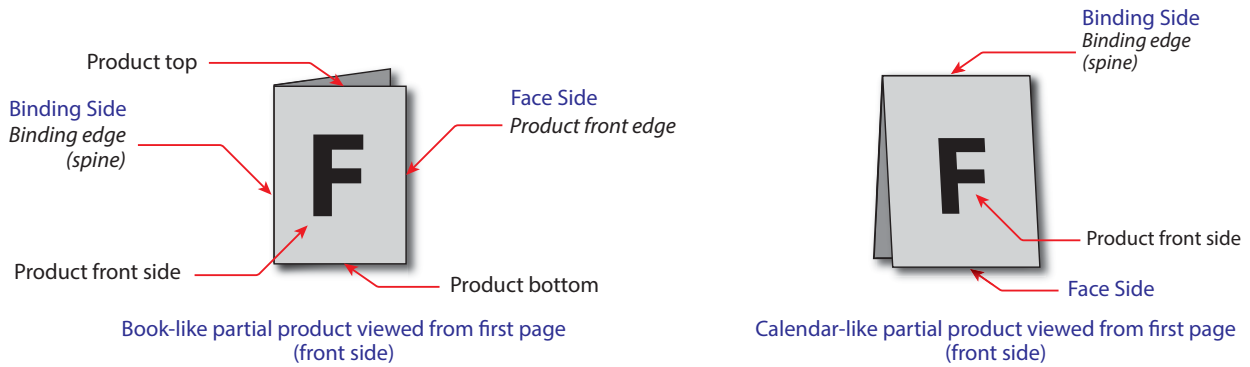

Resource Properties

- Resource Class: Quantity
- Resource referenced by: [Bundle/BundleItem](#), [DigitalPrintingParams](#), [FeedingParams/Feeder](#), [FeedingParams/CollatingItem](#)
- Example Partition: "Condition", "RibbonName", "SheetName", "SignatureName", "WebName"
- Input of Processes: Any product intent node (▶ Section 7.0.1 Product Intent Descriptions), [ConventionalPrinting](#), [DigitalPrinting](#), [Varnishing](#), [BlockPreparation](#), [BoxFolding](#), [BoxPacking](#), [Bundling](#), [CaseMaking](#), [CasingIn](#), [ChannelBinding](#), [CoilBinding](#), [Collecting](#), [CoverApplication](#), [Creasing](#), [Cutting](#), [Embossing](#), [EndSheetGluing](#), [Feeding](#), [Folding](#), [Gathering](#), [Gluing](#), [HeadBandApplication](#), [HoleMaking](#), [Inserting](#), [Jacketing](#), [Labeling](#), [Laminating](#), [Numbering](#), [Palletizing](#), [Perforating](#), [PlasticCombBinding](#), [PrintRolling](#), [RingBinding](#), [ShapeCutting](#), [Shrinking](#), [SpinePreparation](#), [SpineTaping](#), [Stacking](#), [StaticBlocking](#), [Stitching](#), [Strapping](#), [StripBinding](#), [ThreadSealing](#), [ThreadSewing](#), [Trimming](#), [WebInlineFinishing](#), [Winding](#), [WireCombBinding](#), [Wrapping](#)
- Output of Processes: Any product intent node (▶ Section 7.0.1 Product Intent Descriptions), [ConventionalPrinting](#), [DigitalPrinting](#), [Varnishing](#), [BlockPreparation](#), [BoxFolding](#), [BoxPacking](#), [Bundling](#), [CaseMaking](#), [CasingIn](#), [ChannelBinding](#), [CoilBinding](#), [Collecting](#), [CoverApplication](#), [Creasing](#), [Cutting](#), [Embossing](#), [EndSheetGluing](#), [Feeding](#), [Folding](#), [Gathering](#), [Gluing](#), [HeadBandApplication](#), [HoleMaking](#), [Inserting](#), [Jacketing](#), [Labeling](#), [Laminating](#), [Numbering](#), [Palletizing](#), [Perforating](#), [PlasticCombBinding](#), [PrintRolling](#), [RingBinding](#), [ShapeCutting](#), [Shrinking](#), [SpinePreparation](#), [SpineTaping](#), [Stacking](#), [StaticBlocking](#), [Stitching](#), [Strapping](#), [StripBinding](#), [ThreadSealing](#), [ThreadSewing](#), [Trimming](#), [WebInlineFinishing](#), [Winding](#), [WireCombBinding](#), [Wrapping](#)

Table 8.44: Component Resource (Sheet 1 of 4)

NAME	DATA TYPE	DESCRIPTION
AssemblyIDs ? New in JDF 1.3	NMTOKENS	@ AssemblyIDs of the Assembly , AssemblySection or StrippingParams (@ BinderySignatureName) which this Component carries.

Table 8.44: Component Resource (Sheet 2 of 4)

NAME	DATA TYPE	DESCRIPTION
<i>Automation</i> ? New in JDF 1.5	enumeration	Identifies dynamic and static components. When a Component is referenced from a binding process, <i>@Automation</i> modifies the scope of the Component that SHALL be bound. If <i>@Automation="Static"</i> , the individual Component elements that SHALL be bound are one instance of the referenced Component . If <i>@Automation="Dynamic"</i> , the individual Component elements that SHALL be bound are identified by the Component of the referenced partition. This may either be marked by the availability of all child partitions of the referenced partition or by the number of surfaces matching the value of <i>@SurfaceCount</i> specified in the <i>IdentificationField</i> or pipe JMF messages, respectively. The structure of <i>@PartIDKey</i> generation for automated imposition is defined in detail in: ▶ Section 6.3.18.3 Execution Model for Automated Imposition. This structure SHALL be retained in the Component description. If <i>@Automation="Dynamic"</i> and <i>Resource/@PipeID</i> is also present, details MAY be specified in JMF pipe messages. See ▶ Section 4.3.3.1 Dynamic Pipes. If an <i>IdentificationField/MetadataMap</i> element is present, the details SHALL be controlled by the barcode that is represented by <i>IdentificationField/MetadataMap</i> . Allowed value is from: ▶ Automation.
<i>CartonTopFlaps</i> ? New in JDF 1.3	XYPair	Size (F1,F2) (see ▶ Figure 8-7: Box packing) of the two top flaps of a carton or box. SHALL NOT be specified unless <i>@ProductType="Carton"</i> or <i>@ProductType="Box"</i> .
<i>Columns</i> ? New in JDF 1.5	integer	Number of columns of images that are placed on a finished roll, such as by the Winding process. This value is typically used to describe rolls with multiple columns of printed labels.
<i>ComponentType</i> Modified in JDF 1.3	enumerations	Specifies the category of the component. Allowed values are: Block – Folded or stacked product (e.g., book block). Other – The Component describes a sample that has not been produced in this job. Examples are perfume samples, CDs or toys that are inserted into a printed product. New in JDF 1.3 Ribbon – The Component is a ribbon on a web press. Sheet – Single layer (sheet) of paper. Web – The Component is a web on a web press. FinalProduct – The Component is the final product that was ordered by the customer. PartialProduct – The Component is an intermediate product that will be input to a following process. Proof – The Component is a proof (e.g., a press proof or output from a digital press). Note that in JDF 1.2 , proof was defined in the 1st list of categories, above. Modified in JDF 1.3 Constraint: Further details of the component are specified in <i>@ProductType</i> . At most one of "FinalProduct", "PartialProduct" or "Proof" SHALL be specified in addition to one of the first five enumerations specified as values.
<i>Dimensions</i> ?	shape	The dimensions of the component. These dimensions MAY differ from the original size of the original product. For example, the dimensions of a folded sheet MAY be unequal to the dimensions of the sheet before it was folded. The dimension is always the bounding box around the Component . If not specified, a portrait orientation (Y > X) is assumed. If an unfolded Component references <i>Media</i> , then the Z-value of <i>@Dimensions</i> SHOULD correspond to the value of <i>Media/@Thickness</i> transformed from microns to points. Note: It is crucial for enabling postpress to specify <i>@Dimensions</i> unless they really are unknown.
<i>IsWaste="false"</i> Deprecated in JDF 1.4	boolean	If "true", the Component is waste from a previous process that can be used to set up a machine. Deprecation note: Starting with JDF 1.4 , use partitioning with <i>@Condition</i> instead of <i>@IsWaste</i> .
<i>MaxHeat</i> ?	double	Maximum temperature the Component can resist.

Table 8.44: Component Resource (Sheet 3 of 4)

NAME	DATA TYPE	DESCRIPTION
<i>Overfold</i> ? New in JDF 1.1	double	Expansion of the overfold of a Component . This attribute is needed for Inserting or other postpress processes.
<i>OverfoldSide</i> ? New in JDF 1.1	enumeration	Specifies the longer side of a folded component. Allowed value is from: ▶ Side.
<i>PageListIndex</i> ? New in JDF 1.3	IntegerRangeList	List of the indices of the PageData elements of the PageList specified in this Component .
<i>ProductType</i> ? Modified in JDF 1.5	NMTOKEN	Type of product that this component specifies. Values include those from: ▶ Product Types.
<i>ProductTypeDetails</i> ? New in JDF 1.3	string	<i>@ProductTypeDetails</i> specifies additional details of the product that may be site specific and may be human readable. <i>@ProductType</i> SHOULD be specified if <i>@ProductTypeDetails</i> is supplied. If <i>@ProductType</i> ="BlankBox" or <i>@ProductType</i> ="FlatBox", <i>@ProductTypeDetails</i> specifies a box type (e.g., ▶ [ECMA], ▶ [FEFCO] or company internal box type standard). Values include: NewspaperNormal – Standard newspaper. NewspaperMixed – multiple Component resources of a newspaper are produced in parallel. NewspaperCombi – Component resources are collected to one Component in an inline production chain after press.
<i>ReaderPageCount</i> ? New in JDF 1.1	integer	Total amount of individual reader pages that this Component contains. Count of -1 means "unknown." If not specified, the value is unknown.
<i>SheetPart</i> ?	rectangle	Only used if contains (<i>@ComponentType</i> , "Block") and Layout is present. Position of the block on the Layout in <i>@SurfaceContentsBox</i> coordinates used in this Component .
<i>SourceRibbon</i> ? Deprecated in JDF 1.3	string	SHALL NOT be specified unless contains (<i>@ComponentType</i> , "Ribbon"). <i>@RibbonName</i> of the ribbon used in this Component . Deprecation note: Starting with JDF 1.3, use a direct reference to the Layout Partition that represents the ribbon.
<i>SourceSheet</i> ? Deprecated in JDF 1.3	string	SHALL NOT be specified unless contains (<i>@ComponentType</i> , "Sheet") or contains (<i>@ComponentType</i> , "Block"). Matches the Layout/Signature/Sheet/ <i>@Name</i> used in this Component . Deprecation note: Starting with JDF 1.3, use a direct reference to the Layout partition that represents the sheet.
<i>SourceWeb</i> ? Deprecated in JDF 1.3	string	SHALL NOT be specified unless contains (<i>@ComponentType</i> , "Ribbon"). <i>@WebName</i> of the ribbon used in this Component . Deprecation note: Starting with JDF 1.3, use a direct reference to the Layout partition that represents the web.
<i>SpineThickness</i> ? New in JDF 1.4	double	Thickness
<i>SurfaceCount</i> ? New in JDF 1.1	integer	Total amount of individual surfaces that this Component contains. Note: A sheet always has two surfaces regardless of the number of images or reader pages. In case of homogeneous Component elements, <i>@SurfaceCount</i> refers to surfaces with a size of Component/ <i>@Dimensions</i> .
<i>Transformation</i> ? Deprecated in JDF 1.1	matrix	Matrix describing the transformation of the orientation of a Component for the process using this resource as input. This is needed to convert the coordinate system of the Component to the coordinate system of the process. When this attribute is not present, the identity matrix (1 0 0 1 0 0) is assumed. In version 1.1 and beyond, use ResourceLink/ <i>@Transformation</i> or ResourceLink/ <i>@Orientation</i> .

Table 8.44: Component Resource (Sheet 4 of 4)

NAME	DATA TYPE	DESCRIPTION
<i>WindingResult</i> ? New in JDF 1.5	integer	Orientation of the finished product on the roll. For an image, see ▶ Figure 8-15: Orientation of the finished product on the roll. The integers in the figure correspond to values specified by the labeling trade association, refer to ▶ [FINAT]. Note: The orientation and number of windings in a <i>Winding</i> process are modified based on the value of <i>@WindingResult</i> .
<i>Assembly</i> ? New in JDF 1.3	refelement	Specifies the assembly of the <i>Component</i> . In case of a newspaper or web press, the output <i>Component</i> MAY already be built up of several “booklets”. <i>@AssemblyIDs</i> additionally specifies which <i>AssemblySection</i> elements of the <i>Assembly</i> belong to this <i>Component</i> .
<i>Bundle</i> ? New in JDF 1.1	refelement	Description of a <i>Bundle</i> of <i>Component</i> resources if the <i>Component</i> represents multiple individual items. If no <i>Bundle</i> is present, the <i>Component</i> represents an individual item. Note that it is essential to keep a reference of the child <i>Component</i> resources that comprise a <i>Component</i> , as this information is useful to postpress processes.
<i>Disjointing</i> ?	element	A stack of components can be processed using physical separators. This is useful in operations such as feeding.
<i>Layout</i> ? New in JDF 1.2	refelement	Specifies the original <i>Layout</i> of the source sheet of the <i>Component</i> if it contains (<i>@ComponentType</i> , “Sheet”) or contains (<i>@ComponentType</i> , “Block”). The original sheet is the <i>Layout</i> partition element where <i>@SourceSheet</i> matches the <i>Layout/@SheetName</i> used in this <i>Component</i> .
<i>Media</i> ? New in JDF 1.4	refelement	<i>Media</i> for the component. The coordinate system of <i>Media</i> coincides with the coordinate system of the component.
<i>PageList</i> ? New in JDF 1.3	refelement	Specification of page metadata for pages described by this <i>Component</i> .
<i>Sheet</i> ? Deprecated in JDF 1.2	refelement	The <i>Sheet</i> resource that describes the details of this <i>Component</i> if it contains (<i>@ComponentType</i> , “Sheet”) or contains (<i>@ComponentType</i> , “Block”). Replaced with <i>Layout</i> in JDF 1.2 and beyond. The sheet in the referenced <i>Layout</i> is accessed by matching <i>@SourceSheet</i> with <i>Layout/Signature/Sheet/@Name</i> .

Figure 8-15: Orientation of the finished product on the roll

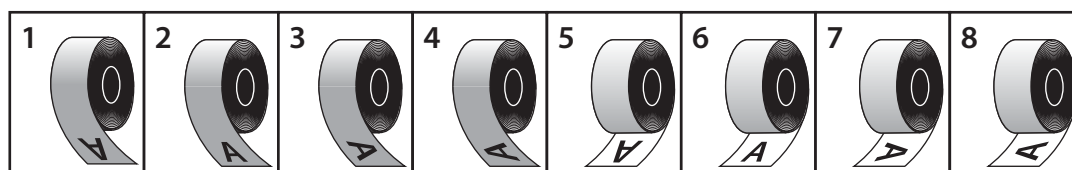

Table 8.45: ProductType Attribute Values (Sheet 1 of 3)

VALUE	DESCRIPTION
<i>BackCover</i>	The last page or sheet of a softcover book or magazine, commonly a heavier media.
<i>BlankBox</i> New in JDF 1.3	Cut, Unfolded box, input for folder-gluer
<i>BlankSheet</i> New in JDF 1.4	An unprinted divider page or sheet. Also describes die-cut unprinted label.

Table 8.45: ProductType Attribute Values (Sheet 2 of 3)

VALUE	DESCRIPTION
BlankWeb New in JDF 1.4	A web with connected blanks after a die cutting.
Body New in JDF 1.2	Generic content inside of a cover, e.g. BookBlock . Also, in page assembly, the main text content (body copy), in contrast to headings or front matter.
Book	Body with a cover and a spine.
BookBlock	The assembled body of pages for a hardcover book.
BookCase	The assembled covers and spine component of a hardcover book, prior to "casing in" (attaching to the book block).
Booklet New in JDF 1.6	Body with a cover without a spine (typically stapled).
Box	Convenience packaging that is not envisioned to be protection for shipping.
Brochure	A single folded sheet.
BusinessCard	A small card that displays contact information for an individual employed by a company.
Carton	Protection packaging for shipping.
Cover	A single sheet covering a side of a print product.
CoverLetter New in JDF 1.6	A letter accompanying another print product.
EndSheet New in JDF 1.5	A glued sheet that spans and attaches BookBlock to BookCase , in both front and back of a hardcover book, (printed or not).
Envelope New in JDF 1.6	A folded paper container, with sealable flap, that encloses and protects a document or contents.
FlatBox New in JDF 1.3	A folded and glued blank (not opened). Output from a box folder-gluer.
FlatWork New in JDF 1.5	Non-bound, non-folded products or products that only have packaging folds.
FrontCover	The first page or sheet of a softcover book or magazine, commonly a heavier media.
Insert New in JDF 1.2	A product part intended to be inserted into a print product.
Jacket	Hardcover case jacket.
Label	A piece of paper or plastic that is attached to an object in order to give information about it.
Leaflet New in JDF 1.6	A single unfolded sheet.
Letter New in JDF 1.6	A written or printed communication addressed to a person or organization and usually transmitted by mail or messenger.
Map New in JDF 1.6	A drawing/representation of a particular area such as a city, or a continent, showing its main features, as they would appear if viewed from above.
Media New in JDF 1.6	Unprinted media, the substrate (usually paper) on which an image is to be printed.

Table 8.45: ProductType Attribute Values (Sheet 3 of 3)

VALUE	DESCRIPTION
Newspaper New in JDF 1.3	A newspaper-product
Notebook New in JDF 1.6	A book or block with a set of identical or similar pages, e.g. a writing tablet, where all page fronts have identical content, and all page backs have identical content.
Pallet New in JDF 1.3	Loaded pallet of boxes, cartons or Component resources
Postcard New in JDF 1.6	A card designed for sending a message by mail without an envelope.
Poster	A large printed picture.
Proof New in JDF 1.6	A representation that visualizes the intended output of page assembly, or the printing process.
ResponseCard New in JDF 1.6	A self mailer to respond to an offer.
Section New in JDF 1.6	Main division of a book, such as a chapter, typically with a name or number.
SelfMailer New in JDF 1.6	A document to be sent via the post without an additional envelope.
Spine New in JDF 1.6	The bound edge of a book. Also, the portion of the cover that connects the front and back cover, wrapping the binding edge.
Stack New in JDF 1.4	Stacked Component s.
Unknown Deprecated in JDF 1.2	
WrapAroundCover New in JDF 1.6	A single cover sheet containing the front cover, spine and back cover.

8.26 Contact

Contact describes a person or a role within an organization. It MAY include an address and communication channels. **Contact**/*@ProductID* SHALL be unique within the company.

Resource Properties

Resource Class: Parameter

Resource referenced by: [Abstract PhysicalResource](#), [ArtDeliveryIntent](#), [ArtDeliveryIntent/ArtDelivery](#), [DeliveryIntent](#), [DeliveryIntent/DropIntent](#), [ApprovalParams/ApprovalPerson](#), [ApprovalSuccess/ApprovalDetails](#), [ContentList/ContentData/ContentMetadata](#), [CustomerInfo](#), [DeliveryParams](#), [DeliveryParams/Drop](#), [DigitalDeliveryParams](#)

Table 8.46: Contact Resource (Sheet 1 of 2)

NAME	DATA TYPE	DESCRIPTION
ContactTypeDetails ? New in JDF 1.2	string	@ContactTypeDetails specifies the details of the contact's role or roles. For instance, if contains (@ContactTypes , "Delivery") this could be a description for which delivery location this Contact is responsible.
ContactTypes Modified in JDF 1.4	NMTOKENS	Classification of the contact. Values include those from: ▶ Contact Types .
UserID ? New in JDF 1.5	string	User ID of user, as specified when logging into the operating system or into the submitting application.

Table 8.46: Contact Resource (Sheet 2 of 2)

NAME	DATA TYPE	DESCRIPTION
Address ?	element	Element describing the address.
ComChannel * Modified in JDF 1.2	element	Communication channels such as phone number or email of the contact. These elements define communication channels that MAY be assigned to multiple persons, for instance the communication channel of a reception area.
Company ? New in JDF 1.1	refelement	Company that this Contact is associated with.
Person ?	element	Name of the contact person.

8.26.1 Company

[Company](#) defines the organization name and organizational units (ORG) of the organizational properties defined in ▶ [vCard]. [@ProductID](#) SHALL be globally unique across all companies.

Table 8.47: Company Element

NAME	DATA TYPE	DESCRIPTION
OrganizationName	string	Name of the organization or company (vCard: ORG:orgnam, e.g. "ABC Inc.").
Contact * Deprecated in JDF 1.1	refelement	A contact of the company. In JDF 1.1 and beyond, contacts reference multiple companies.
OrganizationalUnit *	element	Describes one or more organizational units (vCard: ORG:orgunit), e.g. if two elements are present: 1. "North American Division" and 2. "Marketing".

8.26.2 OrganizationalUnit

Table 8.48: OrganizationalUnit Element

NAME	DATA TYPE	DESCRIPTION
	text	Description of one organizational unit.

8.27 ContactCopyParams

New in JDF 1.1

Element describing the parameters of [ContactCopying](#).

Resource Properties

Resource Class: Parameter

Input of Processes: [ContactCopying](#)

Table 8.49: ContactCopyParams Resource (Sheet 1 of 2)

NAME	DATA TYPE	DESCRIPTION
ContactScreen = "false"	boolean	If @ContactScreen ="true" then a halftone screen on film SHALL be used to produce halftones.
Cycle ?	integer	Number of exposure light units to be used. The amount depends on the subject to be exposed.
Diffusion ?	enumeration	The diffusion foil setting. Allowed values are: On Off
PolarityChange = "true"	boolean	If @PolarityChange ="true" then the copy SHALL change polarity with respect to the original image.

Table 8.49: ContactCopyParams Resource (Sheet 2 of 2)

NAME	DATA TYPE	DESCRIPTION
<i>RepeatStep</i> ="11"	XYPair	Number (as integer values) of copies in each direction for a step/repeat camera.
<i>Vacuum</i> ?	double	Amount of vacuum pressure to be used, measured in bars.
<i>ScreeningParams</i> ?	refelement	Properties of the halftone screen on film. Ignored if <i>@ContactScreen</i> ="false".

8.28 ContentList

New in JDF 1.3

ContentList provides a list of **ContentData** elements. **ContentData** elements are independent of pages. Thus multiple **ContentData** elements MAY reside on one page, and a **ContentData** element MAY span multiple pages.

Resource Properties

Resource Class: Parameter

Resource referenced by: **PublishingIntent**, **LayoutElement**, **PageList**,

Table 8.50: ContentList Resource

NAME	DATA TYPE	DESCRIPTION
ContentData + Modified in JDF 1.4	element	Details of the individual content element. A ContentData element is referred to by its ID (i.e., the value of ContentData / <i>@ID</i>). Modification note: Before JDF 1.4, a ContentData element was referred to by its index in ContentList with the warning that ContentData elements not be removed or inserted in a position other than the end of the list.

8.28.1 ContentData

ContentData defines the additional metadata of individual elements of a page. If the **ContentList** is partitioned, the index refers to **ContentData** elements in the respective leaves of the partitioned **ContentList**. The index restarts at 0 with each partitioned leaf.

Table 8.51: ContentData Element (Sheet 1 of 2)

NAME	DATA TYPE	DESCRIPTION
<i>CatalogDetails</i> ? Deprecated in JDF 1.6	string	Additional details of a resource in a catalog environment.
<i>CatalogID</i> ? Deprecated in JDF 1.6	string	Identification of the resource (e.g., in a catalog environment).
<i>ContentRefs</i> ? New in JDF 1.4	IDREFS	List of ContentData / <i>@ID</i> values that specify the ContentData elements children of this ContentData element. For instance, a book may refer to individual chapters. The reference ContentData object SHALL reside in the same ContentList as this ContentData .
<i>ContentType</i> ?	NMTOKEN	Type of content. Values include those from: ▶ Content Types.
<i>HasBleeds</i> ?	boolean	If "true", the file has bleeds.
<i>ID</i> ? New in JDF 1.4	ID	For reference by <i>@ContentRefs</i> .
<i>IsBlank</i> ?	boolean	If "true", the has no content marks and is blank.
<i>IsTrapped</i> ?	boolean	If "true", the file has been trapped.
<i>JobID</i> ?	string	ID of the job that this ContentData belongs to.
<i>ProductID</i> ?	string	An ID of the ContentData as defined in the MIS system.

Table 8.51: ContentData Element (Sheet 2 of 2)

NAME	DATA TYPE	DESCRIPTION
ContentMetadata ? New in JDF 1.4	element	Container for document related metadata such as ISBN, Author etc.
ElementColorParams ?	refelement	Color details of the ContentData element.
ImageCompressionParams ?	refelement	Specification of the image compression properties.
OCGControl * New in JDF 1.6	element	OCGControl provides a list of the OCGs (layers) that SHALL be included or excluded. Any OCGs (layers) not listed in an OCGControl element SHALL follow the rules defined by the underlying PDL.
ScreeningParams ?	refelement	Specification of the screening properties of the ContentData element.
SeparationSpec *	element	List of separation names defined in the ContentList .

8.28.2 ContentMetadata

New in JDF 1.4

ContentMetadata is a container for metadata pertaining to this **ContentData** element. Additional metadata fields may be created using **GeneralID**.

Table 8.52: ContentMetadata Element

NAME	DATA TYPE	DESCRIPTION
ISBN ? New in JDF 1.6	NMTOKEN	An International Standard Book Number, that allows for both 10 and 13 digit values, see ▶ [ISO2108:2017]. Note: This replaces @ISBN10 and @ISBN13
ISBN10 ? Deprecated in JDF 1.6	string	A 10 digit ISBN (see ▶ [ISO2108:2017]) Deprecation Note: This has been replaced by @ISBN which allows for both 10 and 13 digit values.
ISBN13 ? Deprecated in JDF 1.6	string	A 13 digit ISBN (see ▶ [ISO2108:2017]) Deprecation Note: This has been replaced by @ISBN which allows for both 10 and 13 digit values.
Title ?	string	The title of the content.
Comment ?	element	If required, an abstract MAY be specified in Comment [@Name="Abstract"].
Contact *	refelement	The person who is responsible for this content.
Employee *	refelement	If required, the author SHOULD be specified in an Employee [contains(@Roles, "Author")].
Part ?	element	If present, conserves the values of the specified partition keys related to the content being processed. It is illegal to set partition key values where that key is used to explicitly partition the referencing resource, or is implied by that resource. Note: This allows partition keys and values to be conserved in a RunList (Surface) or Component .

Example 8.14: ContentList

New in JDF 1.4

```

<RunList Class="Parameter" ID="r071030_02242378_000004" Status="Available">
  <PageListRef rRef="PageList"/>
</RunList>
<PageList Class="Parameter" ID="PageList" Status="Available">
  <ContentListRef rRef="ContentList"/>
</PageList>
<ContentList Class="Parameter" ID="ContentList" Status="Available">
  <ContentData>
    <ContentMetadata ISBN10="0123456789" Title="book thing">
      <Comment ID="c071030_022423109_000005" Name="Abstract">
        Abstract of the book in english
      </Comment>
      <Contact ContactTypes="Editor">
        <Person DescriptiveName="authorName" FamilyName="authorName"/>
      </Contact>
    </ContentMetadata>
  </ContentData>
  <ContentData>
    <ContentMetadata Title="Chapter 1">
      <Contact ContactTypes="Customer">
        <Person DescriptiveName="authorName1" FamilyName="authorName1"/>
      </Contact>
    </ContentMetadata>
  </ContentData>
  <ContentData>
    <ContentMetadata Title="Chapter 2">
      <Contact ContactTypes="Customer">
        <Person DescriptiveName="authorName2" FamilyName="authorName2"/>
      </Contact>
    </ContentMetadata>
  </ContentData>
  <ContentData>
    <ContentMetadata Title="Chapter 3">
      <Contact ContactTypes="Customer">
        <Person DescriptiveName="authorName3" FamilyName="authorName3"/>
      </Contact>
    </ContentMetadata>
  </ContentData>
</ContentList>

```

Example 8.15: ContentList: Extended with ISBN, Author, etc.

New in JDF 1.4

RESOURCES

Example of [ContentList](#) with ISBN, Author, etc.

```
<!-- Information about the input (file, author) -->
<RunList Class="Parameter" ID="NodeIDRunList" Status="Available">
  <LayoutElementRef rRef="NodeIDLE"/>
  <PageList>
    <ContentList>
      <ContentData>
        <!-- String for title -->
        <new:DocumentInfo ISBN="0123456789"
          Title="This is the title of the book" xmlns:new="new_schema_URI">
          <!-- Multi-lines string for Abstract -->
          <new:DocumentAbstract>This is the abstract of the book
            It has several lines...</new:DocumentAbstract>
          <!-- List of authors. Using a PersonRef allows reusing the same Person element -->
          <new:Author Subject="Preface">
            <PersonRef rRef="AuthorID1"/>
          </new:Author>
          <new:Author Subject="Content">
            <new:PersonRef rRef="AuthorID2"/>
            <new:PersonRef rRef="AuthorID3"/>
          </new:Author>
        </new:DocumentInfo>
      </ContentData>
    </ContentList>
  </PageList>
</RunList>
<LayoutElement Class="Parameter" ID="NodeIDLE" Status="Available">
  <FileSpec MimeType="application/pdf"
    URL="file:///hotfolder/files/Document2747.pdf" UserFileName="JDF1.3.pdf"/>
</LayoutElement>
<!-- Information about the authors -->
<Person Class="Parameter" FamilyName="Smith" FirstName="James"
  ID="AuthorID1" JobTitle="Author" Status="Available"/>
<Person Class="Parameter" FamilyName="Smith" FirstName="John"
  ID="AuthorID2" JobTitle="Author" Status="Available"/>
<Person Class="Parameter" FamilyName="Smith" FirstName="William"
  ID="AuthorID3" JobTitle="Author" Status="Available"/>
<!-- Media: A3 white paper coated on both sides, 70 gr/m2 -->
<Media BackCoatings="Coated" Class="Consumable" Dimension="1190 842"
  FrontCoatings="Coated" ID="MediaID" MediaColorName="White"
  MediaType="Paper" Status="Available" Weight="70"/>
<!-- Media: A4 yellow paper for Banner Page -->
<Media Class="Consumable" Dimension="595 842" ID="MediaID2"
  MediaColorName="Yellow" MediaType="Paper" Status="Available" Weight="70"/>
<!-- Booklet layout + banner page with ISBN and Authors printed on it -->
<LayoutPreparationParams BindingEdge="Left" Class="Parameter"
  FinishingOrder="GatherFold" FoldCatalog="F4-1" ID="NodeIDLPP"
  NumberUp="2 1" PageDistributionScheme="Saddle"
  PresentationDirection="FoldCatalog" Sides="TwoSidedFlipY" Status="Available">
  <InsertSheet IsWaste="true" SheetFormat="Standard"
    SheetType="JobSheet" SheetUsage="Header">
    <Layout>
      <MediaRef rRef="MediaID2"/>
      <MarkObject CTM="1 0 0 1 0 0">
        <JobField ShowList="new:ISBN new:Authors"/>
      </MarkObject>
    </Layout>
  </InsertSheet>
</LayoutPreparationParams>
```

8.29 ConventionalPrintingParams

[ConventionalPrintingParams](#) defines the device specific setup of the [ConventionalPrinting](#) process.

Resource Properties

Resource Class: Parameter

Example Partition: "BlockName", "FountainNumber", "PartVersion", "RibbonName", "Separation", "SheetName", "Side", "SignatureName", "WebName", "WebProduct"

Input of Processes: ConventionalPrinting

Table 8.53: ConventionalPrintingParams Resource (Sheet 1 of 2)

NAME	DATA TYPE	DESCRIPTION
<i>DirectProof</i> ="false"	boolean	If "true", the proof is directly produced. Subsequently an approval might be given by a person (e.g., the customer, foreman or floor manager) shortly after the first final-quality printed sheet is printed. The approval is needed for the actual print run, and not for setup. If the ConventionalPrinting process is awaiting approval of a direct proof, the <i>@Status</i> of the JDF node is switched to "Suspended" with the <i>@StatusDetails</i> ="WaitForApproval".
<i>Drying</i> ?	enumeration	The way in which ink is dried after a print run. Allowed value is from: ▶ Drying.
<i>FirstSurface</i> ? Modified in JDF 1.2	enumeration	Printing order of the surfaces on the sheet. Allowed values are: Either – Deprecated in JDF 1.2 Deprecation note: Starting with JDF 1.2, omit <i>@FirstSurface</i> to specify "Either". Front Back
<i>FountainSolution</i> ?	enumeration	State of the fountain solution module in the printing units. Allowed values are: On Off
<i>MediaLocation</i> ?	string	Identifies the location of the Media . The value identifies a physical location on the press (e.g., unwinder 1, unwinder 2 and unwinder 3). If the media resource is partitioned by <i>@Location</i> (see also ▶ Section 3.10.6.4 Locations of PhysicalResources) there SHOULD be a match between one <i>@Location</i> partition key and this <i>@MediaLocation</i> value. Values include those from: ▶ Input Tray and Output Bin Names. Note: The specified values are for printer locations.
<i>ModuleAvailableIndex</i> ? New in JDF 1.1 Deprecated in JDF 1.4	IntegerRangeList	Zero-based list of print modules that are available for printing. In some cases modules are not available because the print module is replaced with in-line tooling (e.g., a perforating unit). If not specified, all modules are used for printing. The list is based on all modules of the printer and is not influenced by the value of <i>@ModuleIndex</i> . Deprecation note: Starting with JDF 1.4, the skipping of press modules is now handled by specifying <i>ColorantControl/DeviceColorantOrder/SeparationSpec</i> with no <i>@Name</i>
<i>ModuleDrying</i> ?	enumeration	The way in which ink is dried in individual modules. Allowed value is from: ▶ Drying.
<i>ModuleIndex</i> ?	IntegerRangeList	Zero-based, ordered list of print modules that are to be used. <i>@ModuleIndex</i> does not influence the ink sequence. It is used only to skip individual modules. The list is based on all modules of the printer and is not influenced by the value of <i>@ModuleAvailableIndex</i> . Note: Starting with JDF 1.4, the skipping of press modules SHOULD additionally be specified by supplying <i>ColorantControl/DeviceColorantOrder/SeparationSpec</i> with no <i>@Name</i> .
<i>NonPrintableMarginBottom</i> ? New in JDF 1.3	double	The width in points of the bottom margin measured inward from the edge of the Media with respect to the idealized process coordinate system of the ConventionalPrinting process. The Media origin is unaffected by <i>@NonPrintableMarginBottom</i> .
<i>NonPrintableMarginLeft</i> ? New in JDF 1.3	double	Same as <i>@NonPrintableMarginBottom</i> except for the left margin.

Table 8.53: ConventionalPrintingParams Resource (Sheet 2 of 2)

NAME	DATA TYPE	DESCRIPTION
NonPrintableMargin Right ? New in JDF 1.3	double	Same as @NonPrintableMarginBottom except for the right margin.
NonPrintableMargin Top ? New in JDF 1.3	double	Same as @NonPrintableMarginBottom except for the top margin.
PerfectingModule ? New in JDF 1.1	integer	Index of the perfecting module if @WorkStyle="Perfecting" and multiple perfecting modules are installed.
Powder ?	double	Quantity of powder in percent.
PrintingTechnology ? New in JDF 1.4 Deprecated in JDF 1.5	enumeration	Printing technology of the press or press module. Allowed values are: Flexo Gravure Offset Screen Deprecation note: Starting with JDF 1.5 , use Color/@PrintingTechnology .
PrintingType Modified in JDF 1.3	enumeration	Type of printing machine. Allowed values are: ContinuousFed – connected sheets including fan fold. New in JDF 1.2 SheetFed – Separate cut sheets. WebFed – Paper supplied to press on rolls. Deprecated in JDF 1.3 WebMultiple – Web printing with multiple plates per cylinder. Generally used with newspaper web printing. New in JDF 1.3 WebSingle – Web printing with only one plate per cylinder. Generally used in commercial and publication workflows. New in JDF 1.3
SheetLay ?	enumeration	Lay of input media. Reference edge of where paper is placed in a feeder. Allowed value is from: ▶ SheetLay .
Speed ? Modified in JDF 1.3	double	Maximum print speed in sheets/hour for sheet-fed or revolutions/hour for web-fed devices. Defaults to device specific full speed.
WorkStyle ?	enumeration	The direction in which to turn the press sheet. Allowed value is from: ▶ WorkStyle .
ApprovalParams ? New in JDF 1.2	refelement	Details of the direct Approval process, when @DirectProof="true" .
Ink * Modified in JDF 1.2 Deprecated in JDF 1.4	refelement	Details of varnishing. Defines the varnish to be used for coatings on printed sides. Coatings are applied after printing all the colors. Other coating sequences SHALL use the partition mechanism of this resource. Selective varnishing in print modules has to use a separate separation for the respective varnish. Varnish is specified by Ink/@Family="Varnish" . If both Ink and ExposedMedia (Plate) are specified for a given separation, spot varnishing is specified. If only Ink and not ExposedMedia (Plate) is specified, overall varnishing is specified. In JDF 1.2 and beyond, Ink MAY occur in multiple times in order to specify multiple layers of varnish. Note: The color inks are direct input resources of the process and SHALL NOT be specified here. Deprecation note: Starting with JDF 1.4 , use Varnishing .

8.30 CoverApplicationParams

New in JDF 1.1

[CoverApplicationParams](#) define the parameters for applying a cover to a book block.

Resource Properties

Resource Class: Parameter

Intent Pairing: [BindingIntent](#)Input of Processes: [CoverApplication](#)

Table 8.54: CoverApplicationParams Resource

NAME	DATA TYPE	DESCRIPTION
CoverOffset ? Deprecated in JDF 1.2	XYPair	Position of the cover in relation to the book block given in the cover-sheet coordinate system. In JDF 1.2 and beyond, @CoverOffset is implied by the transformation matrix of the ResourceLink / @Transformation of the cover's ComponentLink .
GlueApplication *	refelement	Describes where and how to apply glue to the book block.
Score *	element	Describes where and how to score the cover. The sequence of Score elements SHALL specify the sequence in which the tool is applied.

8.30.1 Score

Table 8.55: Score Element

NAME	DATA TYPE	DESCRIPTION
Offset	double	Position of scoring given in the operation coordinate system.
Side ="FromInside"	enumeration	Specifies the side from which the scoring tool works. Allowed values are: FromInside FromOutside

Figure 8-16: Parameters and coordinate system for cover application

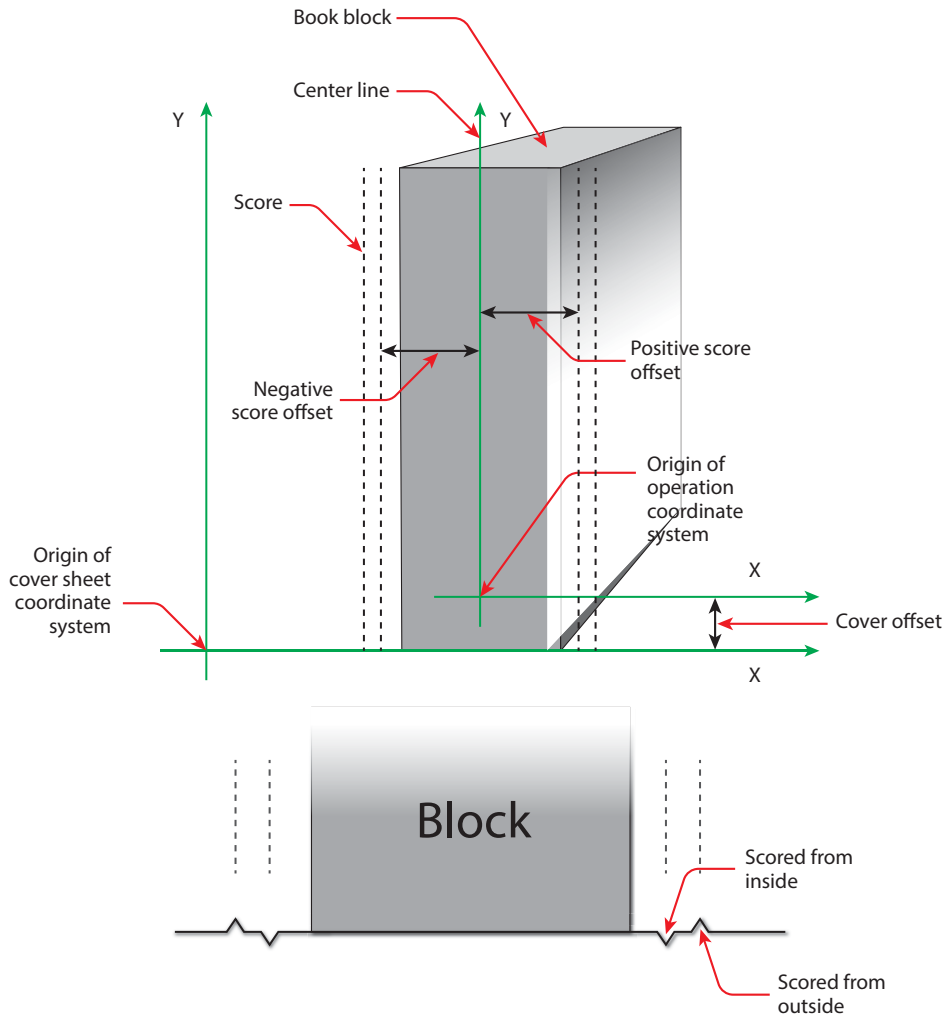

8.31 CreasingParams

New in JDF 1.1

CreasingParams define the parameters for creasing or grooving a sheet.

Resource Properties

- Resource Class: Parameter
- Intent Pairing: **FoldingIntent**
- Example Partition: "BlockName", "RibbonName", "SheetName", "SignatureName", "WebName"
- Input of Processes: **Creasing**

Table 8.56: CreasingParams Resource

NAME	DATA TYPE	DESCRIPTION
Crease *	element	Defines one or more crease lines.

8.32 CustomerInfo

Modified in JDF 1.3

The **CustomerInfo** resource contains information about the customer who orders the job. **CustomerInfo** has been moved from a direct element of **JDF** to a resource in **JDF 1.3**.

Before **JDF 1.3**, **CustomerInfo** was a subelement of a **JDF** node, and “inherited” down to child nodes. Starting with **JDF 1.3**, **CustomerInfo** became a resource that SHALL be linked like any other resource; there is no “inheritance”. Any node MAY link to the same **CustomerInfo** resource as its



Creating Better Job Tracking & Reporting

Customer information within JDF can provide a bridge between your CRM systems and production. How could JDF be used to automate the process of reporting to customers on the status of their jobs?

parent. A normative [CustomerInfo](#) is specified by a linked resource. An informative [CustomerInfo](#) MAY be retrieved by searching for [CustomerInfo](#) of parent nodes or ancestor elements

Resource Properties

Resource Class: [Parameter](#)

Resource referenced by: [Ancestor](#)

Input of Processes: [Any Process](#)

Table 8.57: [CustomerInfo](#) Resource

NAME	DATA TYPE	DESCRIPTION
BillingCode ?	string	A code to bill charges incurred while executing the node.
CustomerID ?	string	Customer identification used by the application that created the job. This is usually the internal customer number of the MIS system that created the job.
CustomerJobName ?	string	The name that the customer uses to refer to the job.
CustomerOrderID ?	string	The internal order number in the system of the customer. This number is usually provided when the order is placed and then referenced on the order confirmation or the bill.
CustomerProjectID ? New in JDF 1.2	string	The internal project id in the system of the customer. This number MAY be provided when the order is placed and then referenced on the order confirmation or the bill.
rRefs ? Deprecated in JDF 1.2	IDREFS	Array of IDs of any elements that are specified as ResourceRef elements. In version 1.1 it was the IDREF of a ContactRef . In JDF 1.2 and beyond, it is up to the implementation to maintain references.
Company ? Deprecated in JDF 1.1	refelement	Resource element describing the business or organization of the contact. In JDF 1.1 and beyond, Company affiliation of Contact elements is specified in Contact .
Contact * New in JDF 1.1	refelement	Resource element describing contacts associated with the customer. There SHOULD be one Contact [contains (@ ContactTypes , "Customer")]. Such a Contact specifies the primary customer's name, address etc.
CustomerMessage * New in JDF 1.2 Deprecated in JDF 1.5	element	Element that describes messages to the customer. Deprecation note: Use Comment instead.

8.32.1 CustomerMessage

New in JDF 1.2

Deprecated in JDF 1.5

8.33 CutBlock

Defines a cut block on a sheet. It is possible to define a block that contains a matrix of elements of equal size. In this scenario, the intermediate cut dimension is calculated from the information on element size, block size and the number of elements in both directions. Each cut block has its own coordinate system, which is defined by the [@BlockTrf](#) attribute.

Resource Properties

Resource Class: [Parameter](#)

Resource referenced by: [CuttingParams](#)

Table 8.58: [CutBlock](#) Resource (Sheet 1 of 2)

NAME	DATA TYPE	DESCRIPTION
AssemblyIDs ? New in JDF 1.3	NMTOKENS	The @AssemblyIDs of the Assembly , AssemblySection or StrippingParams [@BinderySignatureName] which are contained in this CutBlock .
BlockElementSize ?	XYPair	Element dimension in X and Y direction. The default value is equivalent to the XYPair value in @BlockSize .

Table 8.58: CutBlock Resource (Sheet 2 of 2)

NAME	DATA TYPE	DESCRIPTION
<i>BlockElementType</i> ?	enumeration	Element type. Allowed values are: <i>CutElement</i> – Cutting element. <i>PunchElement</i> – Punching element.
<i>BlockName</i>	NMTOKEN	Name of the block. Used for reference by the <i>CutMark</i> resource. Note: <i>CutBlock</i> resources are not partitioned although they are nested. The semantics of nested <i>CutBlock</i> elements are different.
<i>BlockSize</i>	XYPair	Size of the block.
<i>BlockSubdivision</i> = "1 1"	XYPair	Number (as integers) of elements in X and Y direction.
<i>BlockTrf</i> = "1 0 0 1 0 0"	matrix	Block transformation matrix. Defines the position and orientation of the block relative to the <i>Component</i> coordinate system.
<i>BlockType</i>	enumeration	Block type. Allowed values are: <i>CutBlock</i> – Block to be cut. <i>SaveBlock</i> – Protected block, cut only via outer contour. <i>TempBlock</i> – Auxiliary block that is not taken into account during cutting. <i>MarkBlock</i> – Contains no elements, only marks.
<i>CutWidth</i> ? New in JDF 1.4	double	Width in points of u-shaped knife, saw blade, etc.
<i>Assembly</i> ? New in JDF 1.3	refelement	<i>Assembly</i> that is referred to by <i>@AssemblyIDs</i> or contains the <i>AssemblySection</i> that is referred to by <i>@AssemblyIDs</i> .

8.34 CutMark

CutMark, along with *CutBlock*, provides the means to position cut marks on the sheet. After printing, these marks can be used to adapt the theoretical block positions (as specified in *CutBlock*) to the real position of the corresponding blocks on the printed sheet.

Resource Properties

Resource Class: Parameter

Resource referenced by: *Layout/MarkObject*









Table 8.59: CutMark Resource

NAME	DATA TYPE	DESCRIPTION
<i>Blocks</i> ? Modified in JDF 1.1	NMTOKENS	Values of the <i>@BlockName</i> partition attributes of the blocks defined by the <i>CutMark</i> resource.
<i>MarkType</i>	enumeration	Cut mark type. Allowed values are from: ▶ Table 8.60 MarkType Attribute Values.
<i>Position</i>	XYPair	Position of the logical center of the cut mark in the coordinates of the <i>MarkObject</i> that contains this mark. Note: The logical center of the cut mark does not always coincide with the center of the visible cut mark symbol.

Table 8.60: MarkType Attribute Values (Sheet 1 of 2)

VALUE	SYMBOL	DESCRIPTION
<i>CrossCutMark</i>		Centered at logical position.

Table 8.60: MarkType Attribute Values (Sheet 2 of 2)

VALUE	SYMBOL	DESCRIPTION
TopVerticalCutMark		Slightly above logical position.
BottomVerticalCutMark		Slightly below logical position.
LeftHorizontalCutMark		Slightly to the left of logical position.
RightHorizontalCutMark		Slightly to the right of logical position.
LowerLeftCutMark		Corner at logical position.
UpperLeftCutMark		Corner at logical position.
LowerRightCutMark		Corner at logical position.
UpperRightCutMark		Corner at logical position.

8.35 CuttingParams

New in JDF 1.1

CuttingParams describes the parameters of a **Cutting** process that uses nested **CutBlock** elements as input.

Resource Properties

Resource Class: Parameter

Intent Pairing: [FoldingIntent](#), [ShapeCuttingIntent](#)

Example Partition: "BlockName", "RibbonName", "SheetName", "SignatureName", "WebName"

Input of Processes: **Cutting**

Table 8.61: CuttingParams Resource (Sheet 1 of 2)

NAME	DATA TYPE	DESCRIPTION
NUpSeparation ? New in JDF 1.4	XYPair	Defines the number of CutBlock elements in x and y direction. For example, a 2-up book sawed apart would have <code>@NUpSeparation="2 1"</code> .
SheetLay ? New in JDF 1.5	enumeration	Lay of the input Component . Allowed value is from: ▶ SheetLay . Note: <code>@SheetLay</code> does not modify the coordinate references of the Cutting process.
Cut *	element	Cut elements describe an individual cut. The cuts shall be performed in the same sequence as they occur in this CuttingParams . Cut elements SHALL NOT be specified if CutBlock elements are specified.
CutBlock *	refelement	One or several CutBlock elements can be used to find the Cutting sequence. The CutBlock elements SHALL NOT be specified if Cut elements are specified.

Table 8.61: CuttingParams Resource (Sheet 2 of 2)

NAME	DATA TYPE	DESCRIPTION
CutMark * Deprecated in JDF 1.3	refelement	CutMark resources can be used to adapt the theoretical cut positions to the real positions of the corresponding blocks on the Component to be cut. Replaced by Component/Layout in JDF 1.3 and above.
FileSpec (CIP3) ? New in JDF 1.5	refelement	Reference to a CIP3 file that contains cutting instructions in the ▶ [CIP3 - PPF] format.

8.36 CylinderLayout

New in JDF 1.3

Describes the mapping of plates to cylinders on a newspaper web press. This information might be important for pre-press systems. For instance, if a system wants to indicate the cylinder position as human readable text on the plate.

Resource Properties

Resource Class: Parameter
 Example Partition: "PlateLayout", "Separation", "WebProduct"
 Output of Processes: **CylinderLayoutPreparation**

Table 8.62: CylinderLayout Resource

NAME	DATA TYPE	DESCRIPTION
DeviceID ?	NMTOKEN	Specifies the Device that this CylinderLayout belongs to.
CylinderPosition +	element	Specifies the position of a plate on a cylinder of a newspaper web press.
Layout ?	refelement	References the Layout that describes the plates to be mounted.

8.36.1 CylinderPosition

Table 8.63: CylinderPosition Element

NAME	DATA TYPE	DESCRIPTION
DeviceModuleIndex	integer	Defines a Module with @ModuleType="PrintModule" within the Device specified by CylinderLayout/@DeviceID . In a newspaper web press, "PrintModule" corresponds to a single cylinder.
PlatePosition	XYPair-RangeList	Specifies where to mount this plate onto the cylinder. See figure below for details.
PlateType = "Exposed"	enumeration	Specifies whether the plate contains content data or represents a dummy plate. Additionally, it indicates where in the workflow it will be produced. Allowed values are: Dummy – Indicates that the plate is a dummy plate. It SHALL be bent by a Bending process, but it is unlikely to be exposed by an ImageSetting process. Exposed – Indicates that the plate contains content data and SHALL be exposed by an ImageSetting process.
PlateUsage = "Original"	enumeration	Specifies, whether a plate has to be produced for a specific web run or not. Allowed values are: Original – indicates that the plate SHALL be produced specifically for this run. Reuse – indicates that a plate of a previous run will be reused (same plate position on the web press). For instance, a dummy on a specific CylinderPosition can be used in multiple web runs.

In ▶ Figure 8-17: Definition of the PlatePosition attribute on a newspaper web press, the direction of the view is from the plate cylinder towards the paper. If this direction is vectored as the direction of the former module, this is a left-printing spot. Otherwise it is a right-printing spot. If a 'left-printing spot' is considered, 'Side A' is to the left and 'Side B' to the right. And vice versa for a 'right-printing spot'. The plate position in X-dimension starts numbering at side B. Thus, for the innermost side B position X="0". For the outermost side A position X="1" for single-width presses. On dou-

ble-width presses, X="3" for the outermost side A position. On triple-width presses, X="5" for the outermost side A position.

Note: The "Back" and "Front" side have the same X position on corresponding segments of a web.

Figure 8-17: Definition of the PlatePosition attribute on a newspaper web press

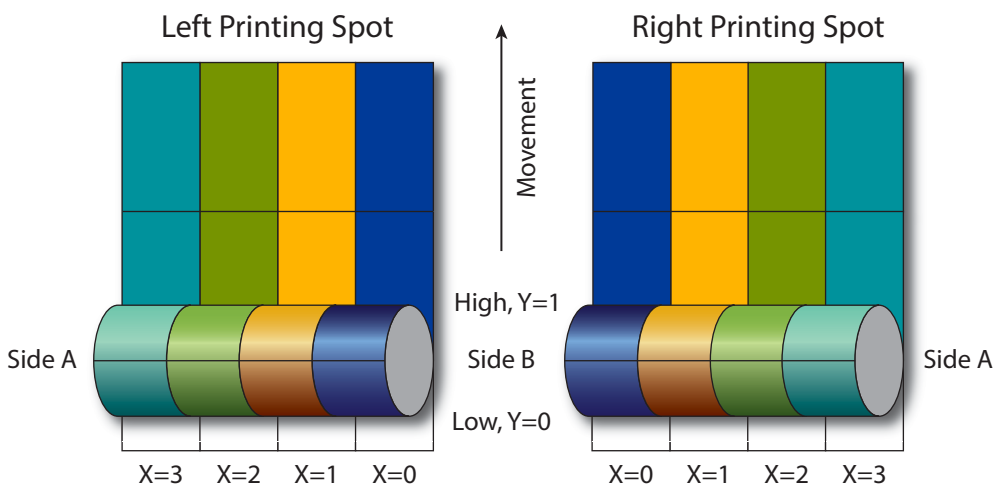

The sketch in ▶ Figure 8-18: Example of a single physical section of eight pages shows a single cylinder of a newspaper web press for a broad sheet production. The numbers indicate reader page numbers. The colored dots indicate color separations. Dummy means no content-bearing plates are mounted on this cylinder position. Instead, so called dummy forms are mounted.

Figure 8-18: Example of a single physical section of eight pages

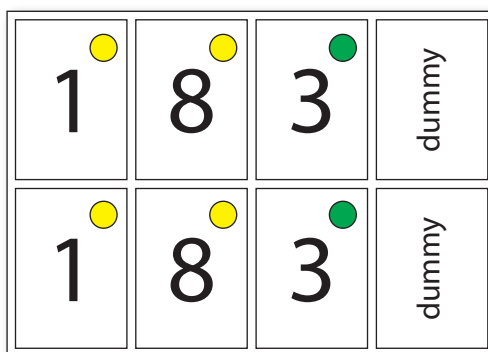

Example 8.16: CylinderLayout

The following **CylinderLayout** is an example representation of the cylinder layout as shown in the sketch.

```

<CylinderLayout Class="Parameter" DeviceID="DEV-001" ID="CL-001"
PartIDKeys="WebSetup PlateLayout Separation" Status="Available">
  <LayoutRef rRef="L-001"/>
  <CylinderLayout WebSetup="Run-1">
    <CylinderLayout PlateLayout="PL-001">
      <CylinderLayout Separation="Yellow">
        <!-- page 1 -->
        <CylinderPosition DeviceModuleIndex="2" PlatePosition="0 0"
          PlateType="Exposed" PlateUsage="Original"/>
        <CylinderPosition DeviceModuleIndex="2" PlatePosition="0 1"
          PlateType="Exposed" PlateUsage="Original"/>
      </CylinderLayout>
    </CylinderLayout>
  </CylinderLayout>
  <CylinderLayout PlateLayout="PL-002">
    <CylinderLayout Separation="Yellow">
      <!-- page 8 -->
      <CylinderPosition DeviceModuleIndex="2" PlatePosition="1 0"
        PlateType="Exposed" PlateUsage="Original"/>
      <CylinderPosition DeviceModuleIndex="2" PlatePosition="1 1"
        PlateType="Exposed" PlateUsage="Original"/>
    </CylinderLayout>
  </CylinderLayout>
  <CylinderLayout PlateLayout="PL-003">
    <CylinderLayout Separation="HKS57">
      <!-- page 3 -->
      <CylinderPosition DeviceModuleIndex="2" PlatePosition="2 0"
        PlateType="Exposed" PlateUsage="Reuse"/>
      <CylinderPosition DeviceModuleIndex="2" PlatePosition="2 1"
        PlateType="Exposed" PlateUsage="Reuse"/>
    </CylinderLayout>
  </CylinderLayout>
  <CylinderPosition DeviceModuleIndex="2" PlatePosition="3 0"
    PlateType="Dummy" PlateUsage="Reuse"/>
  <CylinderPosition DeviceModuleIndex="2" PlatePosition="3 1"
    PlateType="Dummy" PlateUsage="Reuse"/>
</CylinderLayout>
</CylinderLayout>

```

Example 8.17: CylinderLayout: Double-Spread-Page Plate

In case of a double-spread-page plate (or double-truck-page plate) the **CylinderPosition** MAY be set as:

```

<CylinderLayout Class="Parameter" DeviceID="DEV-001" ID="CL-001"
PartIDKeys="WebSetup PlateLayout Separation" Status="Available">
  <!-- ... -->
  <!-- PlatePosition (XYPairRangeList)-->
  <CylinderPosition DeviceModuleIndex="2" PlatePosition="0 0 ~ 1 0"
    PlateType="Exposed" PlateUsage="Original"/>
  <!-- ... -->
</CylinderLayout>

```

8.37 CylinderLayoutPreparationParams

New in JDF 1.3

CylinderLayoutPreparationParams specifies the parameters of the **CylinderLayoutPreparation** process.

Resource Properties

Resource Class:	Parameter
Example Partition:	"WebName", "WebProduct"

Input of Processes: **CylinderLayoutPreparation**

Table 8.64: CylinderLayoutPreparationParams Resource

NAME	DATA TYPE	DESCRIPTION
ProductionPath	refelement	ProductionPath describes the individual paper path through the different modules of a web press.

8.38 DBMergeParams

Deprecated in JDF 1.5

8.39 DBRules

Deprecated in JDF 1.5

8.40 DBSchema

Deprecated in JDF 1.5

8.41 DBSelection

Deprecated in JDF 1.5

8.42 DeliveryParams

[DeliveryParams](#) provides information needed by a **Delivery** process. A **Delivery** process is the sending or receiving of one or more products to one or more delivery destinations. Delivery is also used to specify the scheduled transfer of digital assets.

In order to instruct a digital delivery device to compress or encode the files one can use the input and output [RunList](#) with [FileSpec/@Compression](#) attribute, even if no URL is specified.

Resource Properties

Resource Class: Parameter

Intent Pairing: [ArtDeliveryIntent](#), [DeliveryIntent](#)

Input of Processes: **Delivery**

Table 8.65: DeliveryParams Resource (Sheet 1 of 2)

NAME	DATA TYPE	DESCRIPTION
DeliveryID ?	string	Deliveries with the same @DeliveryID are part of the same physical delivery. This attribute allows items from multiple individual JDF jobs to be delivered in one delivery.
Earliest ?	dateTime	@Earliest SHALL specify the earliest date and time after which the delivery is intended to be made.
EarliestDuration ?	duration	@EarliestDuration SHALL specify the earliest duration by which the delivery SHALL be made relative to the date and time that the order is ready for production.
Method ? Modified in JDF 1.5	string	Specifies a delivery method or brand (e.g., "ExpressMail" or "InterofficeMail"). Values include those from: ▶ Delivery Methods.
Pickup ? Deprecated in JDF 1.2	boolean	If "true", the merchandise is picked up. If "false", the merchandise is delivered. Replaced with @Transfer in JDF 1.2.
Required ?	dateTime	@Required SHALL specify the date and time by which the delivery is intended to be made.
RequiredDuration ?	duration	@RequiredDuration SHALL specify the time duration by which the delivery SHALL be made relative to the date and time that the order is ready for production.
ServiceLevel ? New in JDF 1.2	string	The service level of the specific carrier. Values include those from: ▶ Service Levels.

Table 8.65: DeliveryParams Resource (Sheet 2 of 2)

NAME	DATA TYPE	DESCRIPTION
<i>Transfer</i> ? New in JDF 1.2	enumeration	Describes the direction and responsibility of the transfer. Note: If these values are for <i>DeliveryIntent</i> / <i>@Transfer</i> or <i>DroplIntent</i> / <i>@Transfer</i> , then treat each occurrence of <i>DeliveryParams</i> below as <i>DeliveryIntent</i> . Allowed values are: <i>BuyerToPrinterDeliver</i> – The <i>DeliveryParams</i> describes an input to the job (e.g., a CD for inserting, a preprinted cover, etc.). In this case, the buyer delivers the merchandise to the printer. The printer SHALL specify in the quote a special <i>Contact</i> [contains(<i>./Part</i> / <i>@ContactTypes</i> ="Delivery")]. The <i>Contact</i> specifies where the buyer SHALL send the merchandise. <i>BuyerToPrinterPickup</i> – The <i>DeliveryParams</i> describes an input to the job (e.g., a CD for inserting, a preprinted cover, etc.). In this case, the printer picks up the merchandise. <i>Contact</i> [contains(<i>./Part</i> / <i>@ContactTypes</i> ="Pickup")] specifies where the printer has to pick up the merchandise. <i>PrinterToBuyerDeliver</i> – The <i>DeliveryParams</i> describes an output of the job. In this case, the printer delivers the merchandise to the buyer. The <i>Contact</i> [contains(<i>./Part</i> / <i>@ContactTypes</i> ="Delivery")] specifies where the printer SHALL send the merchandise. <i>PrinterToBuyerPickup</i> – The <i>DeliveryParams</i> describes an output of the job. In this case, the buyer picks up the merchandise. The printer SHALL specify in the quote a special <i>Contact</i> [contains(<i>./Part</i> / <i>@ContactTypes</i> ="Pickup")]. The <i>Contact</i> specifies where the buyer SHALL pick up the merchandise.
<i>Company</i> ? Deprecated in JDF 1.1	reference	Address and further information of the addressee. In JDF 1.1 and beyond, use <i>Contact/Company</i>
<i>Contact</i> * New in JDF 1.1	reference	Address and further information of the <i>Contact</i> responsible for this delivery.
<i>Drop</i> +	element	All locations where the product will be delivered.
<i>FileSpec</i> (<i>DeliveryContents</i>) ? New in JDF 1.6	reference	A <i>FileSpec</i> resource that references a document that SHALL be printed and packaged together with the delivered items.
<i>FileSpec</i> (<i>MailingList</i>) ? New in JDF 1.5	reference	A <i>FileSpec</i> resource pointing to a mailing list. The format of the referenced mailing list is implementation dependent.

8.42.1 Drop

Table 8.66: Drop Element (Sheet 1 of 2)

NAME	DATA TYPE	DESCRIPTION
<i>DropID</i> ? New in JDF 1.5	string	<i>Drop</i> elements with the same <i>@DropID</i> are part of the same drop. This attribute is provided to allow items from multiple individual JDF jobs to be delivered in one drop.
<i>Earliest</i> ?	dateTime	Specifies the earliest time after which the delivery SHALL be made.
<i>Method</i> ? Modified in JDF 1.5	string	Specifies a delivery method (e.g., "ExpressMail" or "InterofficeMail"). Values include those from: ▶ Delivery Methods.
<i>Pickup</i> ? Deprecated in JDF 1.2	boolean	If "true", the merchandise is picked up. If "false", the merchandise is delivered. Default= <i>DeliveryParams</i> / <i>@Pickup</i> . Replaced with <i>@Transfer</i> in JDF 1.2.
<i>Required</i> ?	dateTime	Specifies the time by which the delivery is intended to be made. Default value is from: <i>DeliveryParams</i> / <i>@Required</i>
<i>ServiceLevel</i> ? New in JDF 1.2	string	The service level of the specific carrier. Values include those from: ▶ Service Levels.

Table 8.66: Drop Element (Sheet 2 of 2)

NAME	DATA TYPE	DESCRIPTION
<i>TrackingID</i> ? New in JDF 1.2	string	The string that can help in tracking the delivery. The value of the <i>@TrackingID</i> attribute will depend on the carrier chosen to ship the products.
<i>Transfer</i> ? New in JDF 1.2	enumeration	Describes the direction and responsibility of the transfer. Allowed values are from: <i>DeliveryParams/@Transfer</i> .
<i>Company</i> ? Deprecated in JDF 1.1	refelement	Address and further information of the addressee. Defaults to the value of <i>Company</i> specified in the root <i>DeliveryParams</i> resource.
<i>Contact</i> * New in JDF 1.1	refelement	Address and further information of the contacts responsible for this delivery. Default= <i>DeliveryParams/Contact</i> .
<i>Dropltem</i> +	element	A <i>Drop</i> MAY consist of multiple products, which are represented by their respective <i>PhysicalResource</i> elements. Each <i>Dropltem</i> describes an individual resource that is part of this <i>Drop</i> .
<i>FileSpec</i> (<i>DeliveryContents</i>) ? New in JDF 1.6	refelement	Reference to a document that SHALL be printed and packaged together with the delivered items.

8.42.2 Dropltem

Table 8.67: Dropltem Element (Sheet 1 of 2)

NAME	DATA TYPE	DESCRIPTION
<i>ActualAmount</i> ? New in JDF 1.3	integer	Actual amount of items delivered in this drop. Note that this logs the information after the fact in a way that is similar to an <i>Audit</i> . <i>@ActualAmount</i> was placed here because it is very difficult to map the <i>DeliveryParams</i> structure of individual <i>Drop</i> and <i>Dropltem</i> elements to <i>ResourceLink</i> and <i>Audit</i> elements.
<i>ActualTotalAmount</i> ? New in JDF 1.3	integer	Actual <i>@TotalAmount</i> of items delivered in this drop. Note that this logs the information after the fact in a way that is similar to an <i>Audit</i> . <i>@ActualTotalAmount</i> was placed here because it is very difficult to map the <i>DeliveryParams</i> structure of individual <i>Drop</i> and <i>Dropltem</i> elements to <i>ResourceLink</i> and <i>Audit</i> elements.
<i>Amount</i> ?	integer	Specifies the number of <i>PhysicalResource</i> ordered. If <i>@Amount</i> is not specified, defaults to the total amount of the resource that is referenced by <i>PhysicalResource</i> .
<i>TotalAmount</i> ? New in JDF 1.3	integer	Total amount of individual items delivered in this drop. The <i>@TotalAmount</i> and <i>@Amount</i> differ if the <i>PhysicalResource</i> is a <i>Bundle</i> of multiple resources. The <i>@Amount</i> specifies the number of <i>Bundles</i> (e.g., boxes, pallets etc.). Whereas <i>@TotalAmount</i> specifies the number of final products (e.g., books, magazines etc.).
<i>TotalDimensions</i> ? New in JDF 1.3	shape	Total dimensions in points of all individual items, including packaging delivered in this drop.
<i>TotalVolume</i> ? New in JDF 1.3	double	Total volume in liters of all individual items, including packaging delivered in this drop.
<i>TotalWeight</i> ? New in JDF 1.3	double	Total weight of all individual items, including packaging delivered in this drop.
<i>TrackingID</i> ? New in JDF 1.2	string	The string that can help in tracking the delivery. The value of the <i>@TrackingID</i> attribute will depend on the carrier chosen to ship the products. Defaults to <i>Drop/@TrackingID</i> .
<i>Unit</i> ? Deprecated in JDF 1.6	string	Unit of measurement for the <i>@Amount</i> of the resource that is referenced by <i>PhysicalResource</i> Default value is from: <i>PhysicalResource/@Unit</i> .

Table 8.67: Dropltem Element (Sheet 2 of 2)

NAME	DATA TYPE	DESCRIPTION
Resource ? Modified in JDF 1.2	refelement	Description of the individual item to be delivered. It can be any kind of Resource .

8.43 DevelopingParams

New in JDF 1.1

[DevelopingParams](#) specifies information about the chemical and physical properties of the developing and fixing process for film and plates. Includes details of preheating, post-baking and post-exposure.

- Preheating is necessary for negative working plates. It hardens the exposed areas of the plate to make it durable for the subsequent developing process. The stability and uniformity of the preheat temperature influence the evenness of tints and the run length of the plate on press.
- Post-baking is an optional process of heating that is applied to most polymer plates to enhance the run length of the plate. A factor of 5 to 10 can be gained compared to plates that are not post-baked.
- Post-exposure is an optional exposure process for photopolymer plates to enhance the run length of the plate. A factor of 5 to 10 can be gained compared with plates that are not post-exposed.

Note: Postbaking and post-exposure are mutually exclusive.

Resource Properties

Resource Class: **Parameter**

Input of Processes: **ContactCopying, ImageSetting**

Table 8.68: DevelopingParams Resource

NAME	DATA TYPE	DESCRIPTION
PostBakeTemp ?	double	Temperature of the post-baking process in °C. @PostBakeTemp SHALL NOT be specified if @PostExposeTime is present.
PostBakeTime ?	duration	Duration of the post-baking process. @PostBakeTime SHALL NOT be specified if @PostExposeTime is present.
PostExposeTime ?	duration	Duration of the post-exposing process. @PostExposeTime SHALL NOT be specified if @PostBakeTime is present.
PreHeatTemp ?	double	Temperature of the preheating process in °C.
PreHeatTime ?	duration	Duration of the preheating process.

8.44 Device

Information about a specific device. This can include information on the device’s capabilities. For more information, see ▶ Section 3.8.5.3 ImplementationResource and ▶ Section 10.1 Capability and Constraint Definitions. [Device](#) describes the physical properties of the main device that executes a **JDF** process. See ▶ Chapter 6 Processes. Examples are a press or a finishing machine. See [Tool](#) for a description of auxiliary devices such as fork lifts.

Resource Properties

Resource Class: **Implementation**

Resource referenced by: [PhaseTime](#), [DeviceFilter](#), [IDInfo](#), [DevicInfo](#), [Queue](#), [QueueFilter](#), [DieLayout](#), [DieLayoutProductionParams/ConvertingConfig](#), [InkZoneCalculationParams](#), [RollStand](#), [StrippingParams](#)

Input of Processes: **Any Process**

Table 8.69: Device Resource (Sheet 1 of 3)

NAME	DATA TYPE	DESCRIPTION
DeviceClass ? New in JDF 1.5	NMTOKENS	Indicates the class of device. Multiple NMTOKENS SHALL be used to describe integrated devices with multiple classes. Values include those from: ▶ Device Classes.
DeviceFamily ? Deprecated in JDF 1.1	string	Manufacturer family type ID. The @DeviceFamily is replaced by the appropriate @ModelXXX attributes in this list.

Table 8.69: Device Resource (Sheet 2 of 3)

NAME	DATA TYPE	DESCRIPTION
<i>DeviceID</i> ? New in JDF 1.1	string	Name of the device. <i>@DeviceID</i> SHALL be unique within the workflow. <i>@DeviceID</i> SHALL be the same over time for a specific device instance (i.e., SHALL survive reboots). If the device sends JMF messages, this value SHALL also be used for <i>JMF/@SenderID</i> . For UPNP devices, this SHALL match UPNP:UDN. See ▶ [UPNP]. <i>@DeviceID</i> need not be specified when <i>Device</i> is used as a filter to specify a set of devices.
<i>DeviceType</i> ?	string	Manufacturer type ID, including a revision stamp. Type of the device. Used for grouping and filtering of devices.
<i>Directory</i> ? New in JDF 1.1	URL	Defines a directory where the URLs that are associated with this <i>Device</i> can be located. If <i>@Directory</i> is specified, it SHALL be an absolute URI ▶ [RFC3986] that implicitly also specifies a base URI which is used to resolve any relative URL of <i>Device</i> . See ▶ Appendix J Resolving Directory URL References and ▶ [FileURL].
<i>FriendlyName</i> ? New in JDF 1.1 Deprecated in JDF 1.4	string	Short user-friendly title. Deprecation note: Starting with JDF 1.4, use <i>@DescriptiveName</i> .
<i>ICSVersions</i> ? New in JDF 1.3	NMTOKENS	CIP4 Interoperability Conformance Specification (ICS) Versions that this <i>Device</i> complies with. The value of <i>@ICSVersions</i> SHALL conform to the value format described in ▶ Section 3.2.1 ICS Versions Value.
<i>JDFErrorURL</i> ? New in JDF 1.2	URL	URL where, by default, the device will post JDF output job tickets that are aborted or in error and when <i>NodeInfo/@TargetRoute</i> is not specified. If <i>@JDFErrorURL</i> is specified in the "file" scheme, it SHALL specify a directory. If not specified, <i>@JDFErrorURL</i> defaults to the value of <i>@JDFOutputURL</i> .
<i>JDFInputURL</i> ? New in JDF 1.2	URL	URL where, by default, the device can accept JDF input job tickets. If <i>@JDFInputURL</i> is specified in the "file" scheme, it SHALL specify a directory. The persistence of JDF tickets in this location is implementation dependent. If not specified, the device does not accept JDF without a JMF SubmitQueueEntry .
<i>JDFOutputURL</i> ? New in JDF 1.2	URL	URL where, by default, the device will post JDF output job tickets that are successfully completed and when <i>NodeInfo/@TargetRoute</i> is not specified. If <i>@JDFOutputURL</i> is specified in the "file" scheme, it SHALL specify a directory.
<i>JDFVersions</i> ? New in JDF 1.1	<i>JDFJMF</i> Versions	Whitespace separated list of supported JDF versions that this device supports (e.g., "1.0 1.1" specifies that both the 1.0 and 1.1 versions are supported).
<i>JMFSenderID</i> ? New in JDF 1.1	string	ID of the controller will process JMF messages for the device. This corresponds to the <i>@SenderID</i> attribute that is specified for the device in JMF messages. If a device emits its own JMF messages, this value SHALL match the <i>@DeviceID</i> .
<i>JMFURL</i> ? New in JDF 1.1	URL	URL of the device port that will accept JMF messages. A controller that manages a device MAY specify its own <i>@JMFURL</i> when responding to <i>KnownDevices</i> messages. This is how a controller inserts itself as the manager for a device.
<i>KnownLocalizations</i> ? New in JDF 1.2	languages	A list of all language codes supported by the device for localization. If not specified, then the device supports no localizations.
<i>Manufacturer</i> ? New in JDF 1.1	string	Manufacturer name.
<i>ManufacturerURL</i> ? New in JDF 1.1	string	Web site for manufacturer.
<i>ModelDescription</i> ? New in JDF 1.1	string	Long description for end user.

Table 8.69: Device Resource (Sheet 3 of 3)

NAME	DATA TYPE	DESCRIPTION
<i>ModelName</i> ? New in JDF 1.1	string	Model name.
<i>ModelNumber</i> ? New in JDF 1.1	string	Model number.
<i>ModelURL</i> ? New in JDF 1.1	string	Web site for model.
<i>PresentationURL</i> ? New in JDF 1.1	string	@ <i>PresentationURL</i> specifies a URL to a device-provided user interface for configuration, status, etc. For instance, if the device has an embedded web server, this is a URL to the configuration page hosted on that web server.
<i>Revision</i> ? New in JDF 1.6	string	Hardware or software version of the <i>Device</i> . Note: @ <i>SerialNumber</i> is independent of upgrades whereas @ <i>Revision</i> SHOULD be modified when hardware or software is changed. Note: @ <i>AgentVersion</i> is the version of the JDF interpreter whereas @ <i>Revision</i> applies to the hardware or software of the underlying ▶ Machine.
<i>SecureJMFURL</i> ? New in JDF 1.3	URL	URL of the device port that will accept JMF messages via the "https" protocol.
<i>SerialNumber</i> ? New in JDF 1.1	string	Serial number of the device.
<i>UPC</i> ? New in JDF 1.1	string	Universal Product Code for the device. A 12-digit, all-numeric code that identifies the consumer package. Managed by the Uniform Code.
<i>CostCenter</i> ?	element	MIS cost center ID.
<i>DeviceCap</i> * New in JDF 1.1	element	Description of the capabilities of the device. The <i>DeviceCap</i> elements are combined with a logical OR (i.e., if a JDF resides within any parameter space defined by a <i>DeviceCap</i> , the device can process the job). For details see ▶ Section 10 Device Capabilities.
<i>IconList</i> ? New in JDF 1.1	element	List of locations of icons that can be used to represent the <i>Device</i> .
<i>Location</i> ? New in JDF 1.4	element	Description of the device location.
<i>Module</i> * New in JDF 1.3	element	Individual modules that are represented by this <i>Device</i> .

8.44.1 Icon

New in JDF 1.1

An *Icon* represents a device in the user interface.

Table 8.70: Icon Element (Sheet 1 of 2)

NAME	DATA TYPE	DESCRIPTION
<i>BitDepth</i>	integer	Bit depth of one color.

Table 8.70: Icon Element (Sheet 2 of 2)

NAME	DATA TYPE	DESCRIPTION
<i>IconUsage</i> ?	enumerations	The <i>DeviceInfo</i> / <i>@DeviceStatus</i> of the device that this <i>Icon</i> represents. Any combination of values is allowed. If not specified, the icon is independent of the status of the device. Default value is: a list of all values (i.e., no limit on <i>Icon</i> use). Allowed values are: <i>Unknown</i> – No link to the device exists <i>Idle</i> <i>Down</i> <i>Setup</i> <i>Running</i> <i>Cleanup</i> <i>Stopped</i> Note: The meaning of the individual enumerations is described in the <i>DeviceInfo</i> message element. See ▶ Section 5.27 KnownDevices.
<i>Size</i>	XYPair	Height and width of the icon in pixels.
<i>FileSpec</i>	refelement	Details of the file containing the icon data.

8.44.2 IconList

New in JDF 1.1

The *IconList* is a list of individual icon descriptions.

Table 8.71: IconList Element

NAME	DATA TYPE	DESCRIPTION
<i>Icon</i> +	element	Individual icon description.

8.44.3 Module

New in JDF 1.3

A *Module* represents a physical machine or part of a *Device*.

Table 8.72: Module Element (Sheet 1 of 2)

NAME	DATA TYPE	DESCRIPTION
<i>DeviceType</i> ?	string	Manufacturer type ID, including a revision stamp.
<i>Manufacturer</i> ?	string	Manufacturer name.
<i>ManufacturerURL</i> ?	URL	Web site for manufacturer.
<i>ModelDescription</i> ?	string	Long description for end user.
<i>ModelName</i> ?	string	Model name.
<i>ModelNumber</i> ?	string	Model number.
<i>ModelURL</i> ?	string	Web site for model.
<i>ModuleID</i> ?	NMTOKEN	Identifier of the module. This is a unique identifier within the workflow. <i>@ModuleID</i> SHALL be the same over time for a specific <i>Module</i> instance (i.e., SHALL survive reboots). At least one of <i>@ModuleID</i> or <i>@ModuleIndex</i> SHALL be specified. If multiple logical devices share a physical <i>Module</i> , <i>@ModuleID</i> SHALL be identical. <i>@ModuleID</i> SHOULD be used to specify machines that comprise a <i>Device</i> .
<i>ModuleIndex</i> ?	integer	Zero-based index of the module within the machine. This index is used to reference an individual module. At least one of <i>@ModuleID</i> or <i>@ModuleIndex</i> SHALL be specified. <i>@ModuleIndex</i> SHOULD be used to specify identical modules (e.g., print modules in a complex device).

Table 8.72: Module Element (Sheet 2 of 2)

NAME	DATA TYPE	DESCRIPTION
<i>ModuleType</i> ?	NMTOKEN	Type of <i>Module</i> . Values include those from: ▶ Module Types. Note: The allowed values depend on the type of device. Each type of device has a separate table of values.
<i>Revision</i> ? New in JDF 1.6	string	Hardware or software version of the <i>Module</i> . See <i>Device</i> / <i>@Revision</i> .
<i>SerialNumber</i> ?	string	Serial number of the <i>Module</i> .
<i>SubModuleIndex</i> ?	integer	Zero-based index of the <i>Module</i> in the unit as specified by the parent <i>Module</i> . SHALL NOT be specified if <i>Module</i> is a direct child of <i>Device</i> .
<i>Module</i> *	element	Recursive modules that are part of this module.

8.45 DieLayout

New in JDF 1.3

DieLayout represents a die layout described in an external file. This resource is also used as the input for the actual die making process and is also used in *Stripping*. The external file is by preference a ▶ [DDES3] file. The usage of other files like CFF2, DDES2, DXF or proprietary formats is not excluded but MAY have a negative impact on interoperability.

Resource Properties

- Resource Class: Parameter
- Resource referenced by: *BinderySignature*, *ShapeCuttingParams*
- Input of Processes: *DieDesign*, *DieMaking*
- Output of Processes: *DieDesign*, *DieLayoutProduction*

Table 8.73: DieLayout Resource (Sheet 1 of 2)

NAME	DATA TYPE	DESCRIPTION
<i>CutBox</i> ? New in JDF 1.5	rectangle	A rectangle describing the bounding box of all cut lines in the <i>DieLayout</i> . This is sometimes referred to as the knife to knife dimensions of the <i>DieLayout</i> . If the position on the <i>Media</i> is not known, the lower left SHOULD be set to 0 0.
<i>DieSide</i> ? New in JDF 1.4	enumeration	Determines the die side for which the <i>DieLayout</i> is made. Allowed values are: <i>Down</i> – The <i>DieLayout</i> is made with the knives pointing downwards. <i>Up</i> – The <i>DieLayout</i> is made with the knives pointing upwards.
<i>MediaSide</i> ? New in JDF 1.4	enumeration	Determines the printing side for which the <i>DieLayout</i> is made. "Front" corresponds to the outside of a box, "Back" corresponds to the inside of a box. Allowed value is from: ▶ Side.
<i>Rotated</i> ? New in JDF 1.4	boolean	Indicates if some of the structural designs are oriented cross grain/flute in the layout.
<i>Waste</i> ? New in JDF 1.4	double	The percent of the material that is wasted. Inner waste, i.e. cut out windows, are not included in the waste.
<i>Device</i> * New in JDF 1.4	refelement	The devices for which this <i>DieLayout</i> was made (printing press and die cutter). Typically only the type of device would be used (e.g., the model of the die cutter).
<i>CutLines</i> ? New in JDF 1.6	element	Selects the die line separations from the file referenced by <i>FileSpec</i> . Additional details of the usage of the separations MAY be specified in the respective <i>ColorPool/Color</i> elements.
<i>FileSpec</i> ?	refelement	Reference to an external URL that represents the die. This is typically a CAD design file.

Table 8.73: DieLayout Resource (Sheet 2 of 2)

NAME	DATA TYPE	DESCRIPTION
Media ? New in JDF 1.4	refelement	Media for which this DieLayout was intended. The Media description defines important design parameters as the type of Media , dimensions, grain direction or flute direction.
RuleLength * New in JDF 1.4	element	Elements describing the length of die rules for the different types of rules. Each RuleLength element describes the accumulated length of all rules of a certain type.
Station *	element	Description of the stations in a DieLayout . One Station produces one shape.

8.45.1 RuleLength

New in JDF 1.4

Elements describing the length of die rules for the different types of rules. Each **RuleLength** element describes the accumulated length of all rules of a certain type.

Table 8.74: RuleLength Element

NAME	DATA TYPE	DESCRIPTION
DDESCutType	integer	Type of rule. Values for @DDESCutType SHALL be between "0" and "999". These values correspond to the line type as defined in ▶ [DDES3].
Length	double	Accumulated length of the rules of this type in the DieLayout , in points.

8.45.2 Station

Description of the stations in a **DieLayout**. One station produces one shape type. One **Station** element MAY represent multiple identical one-up stations on an N-up **DieLayout**.

Table 8.75: Station Element

NAME	DATA TYPE	DESCRIPTION
AssemblyIDs ? New in JDF 1.3	NMTOKENS	The list of @AssemblyIDs of the graphic elements that are processed by this Station . Note: @AssemblyIDs was added to JDF 1.3 Errata.
StationAmount = "1"	integer	The number of stations in the DieLayout with this @StationName .
StationName ?	string	The name of the 1-up design in the DieLayout .
ShapeDef ? New in JDF 1.4	refelement	The ShapeDef corresponding to this station in the DieLayout .

8.46 DieLayoutProductionParams

New in JDF 1.4

Parameters for the die layout.

Resource Properties

Resource Class: Parameter

Input of Processes: **DieLayoutProduction**

Table 8.76: DieLayoutProductionParams Resource (Sheet 1 of 2)

NAME	DATA TYPE	DESCRIPTION
Estimate ?	boolean	Determines if the process SHALL run in estimate mode or not. When in estimate mode multiple solutions SHOULD be generated.
Position ?	enumeration	The position of the DieLayout on the sheet. Allowed value is from: ▶ Anchor.

Table 8.76: DieLayoutProductionParams Resource (Sheet 2 of 2)

NAME	DATA TYPE	DESCRIPTION
ConvertingConfig +	element	A ConvertingConfig element describes a range of sheet sizes that can be taken into account to create a new DieLayout . Typically a ConvertingConfig will correspond to a single combination of printing press and further finishing equipment such as die cutters.
RepeatDesc +	element	Step and repeat parameters for a ShapeDef . There is either a single RepeatDesc giving the parameters for all ShapeDef resources at the input or there is exactly 1 RepeatDesc per ShapeDef in the input in which case the sequence of both determines which RepeatDesc should be used for a ShapeDef .

8.46.1 RepeatDesc

New in JDF 1.4

The [RepeatDesc](#) element describes the layout specs for a [ShapeDef](#).

Table 8.77: RepeatDesc Element

NAME	DATA TYPE	DESCRIPTION
AllowedRotate ?	enumeration	Allowed methods to rotate structural designs with respect to grain/flute. Allowed values are: None – No rotation at all. Grain – 0° or 180° rotation. MinorGrain – Device dependent small rotations that retain the general grain direction (e.g., +/- 10°). CrossGrain – Cross grain rotations, e.g. 90°, are acceptable.
GutterX ?	double	Gutter between columns (see also @GutterX2).
GutterX2 ?	double	Secondary gutter between columns. The gutter between columns (2n+0) and (2n+1) is @GutterX and between columns (2n+1) and (2n+2) is @GutterX2 . When @GutterX2 is not specified @GutterX2 = @GutterX . See ▶ Figure 8-25: RepeatDesc using Secondary Gutters.
GutterY ?	double	Gutter between rows (see also @GutterY2).
GutterY2 ?	double	Secondary gutter between rows. The gutter between rows (2n+0) and (2n+1) is @GutterY and between rows (2n+1) and (2n+2) is @GutterY2 . When @GutterY2 is not specified @GutterY2 = @GutterY . See ▶ Figure 8-25: RepeatDesc using Secondary Gutters.
LayoutStyle ?	NMTOKENS	The allowed styles for the layout. Values include: StraightNest Reverse2ndRow Reverse2ndRowAligned Reverse2ndColumn Reverse2ndColumnAligned Note: For diagrams of the above values, see ▶ Figure 8-19: Basic Shape for RepeatDesc/@LayoutStyle examples and the following five figures.
OrderQuantity ?	integer	The order quantity for the 1-up for which this layout will be optimized. This information SHALL be present when a layout is being made for more than one ShapeDef .
UseBleed ?	boolean	If true, the print bleed defined in the structural design SHALL be used to calculate the layout. If false, the outer cut SHALL be used.

The following figure shows the basic shape for subsequent figures that relate to *RepeatDesc*.

Figure 8-19: Basic Shape for RepeatDesc/@LayoutStyle examples

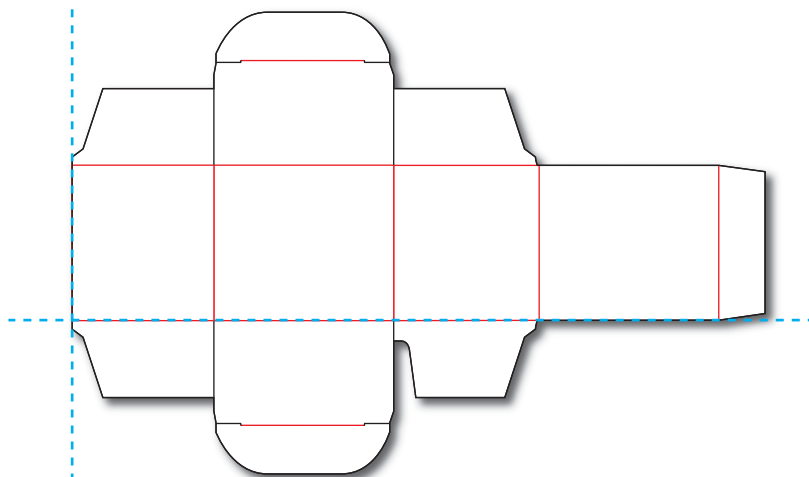
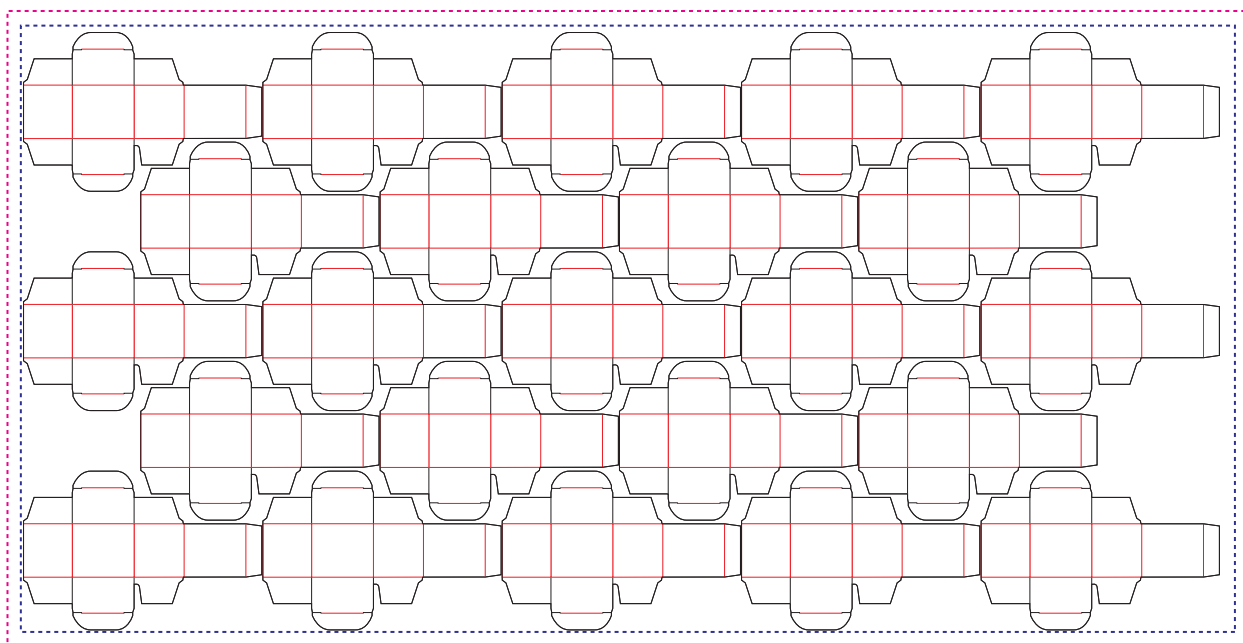

Figure 8-20: RepeatDesc/@LayoutStyle = "StraightNest"



RESOURCES

In the following figure, 1-ups on even rows are rotated 180 degrees. Even rows are shifted horizontally and vertically to obtain optimal nesting.

Figure 8-21: *RepeatDesc/@LayoutStyle = "Reverse2ndRow"*

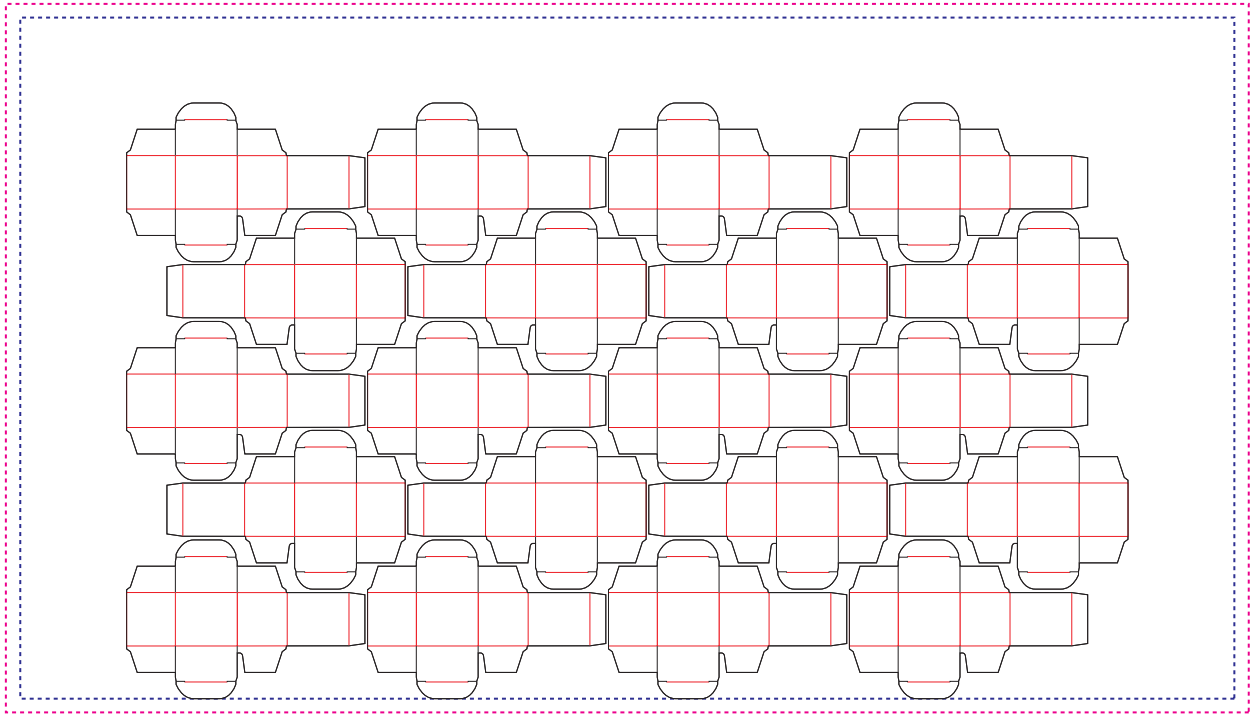

In the following figure, 1-ups on even rows are rotated 180 degrees. Even rows are shifted vertically to obtain optimal nesting. The even rows are not shifted horizontally (left and right edges are aligned between rows).

Figure 8-22: *RepeatDesc/@LayoutStyle = "Reverse2ndRowAligned"*

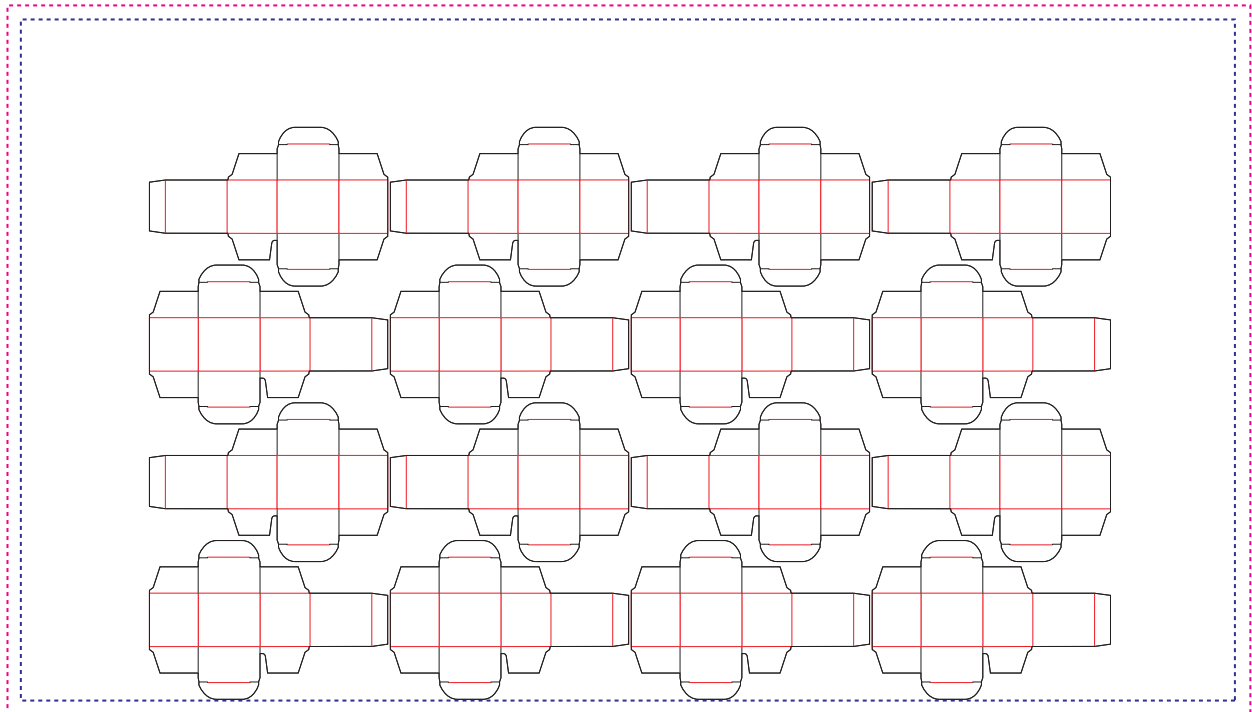

In the following figure, 1-ups on even columns are rotated 180 degrees. Even columns are shifted vertically and horizontally to obtain optimal nesting.

Figure 8-23: RepeatDesc/@LayoutStyle = "Reverse2ndColumn"

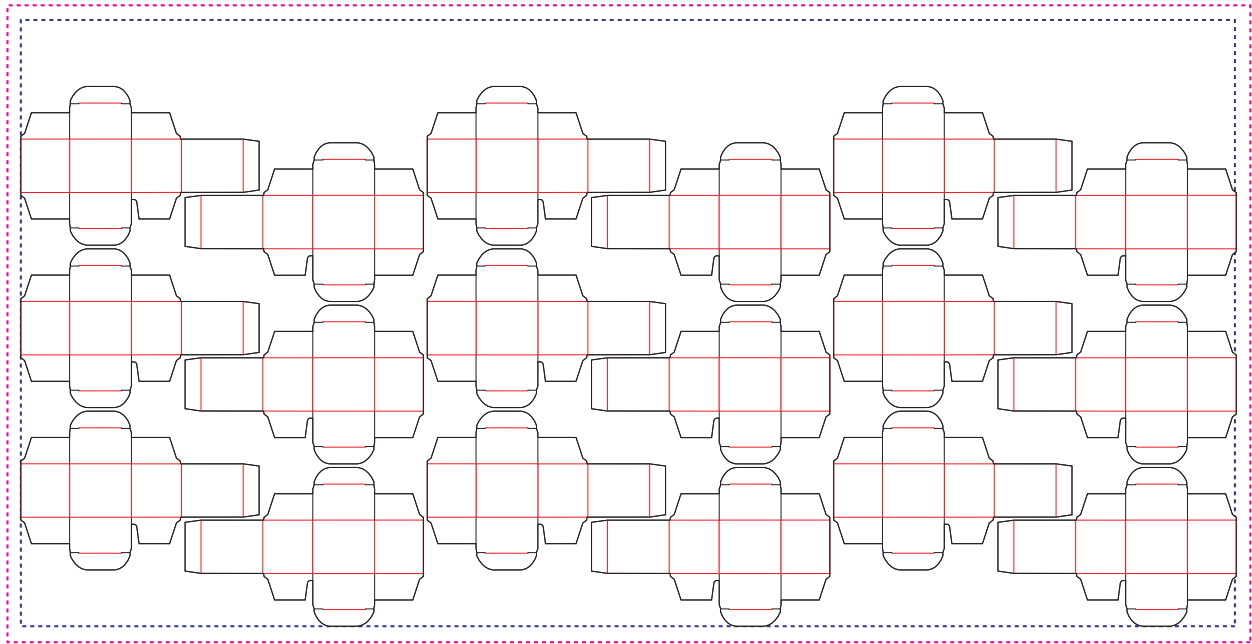

In the following figure, 1-ups on even columns are rotated 180 degrees. Even columns are shifted horizontally to obtain optimal nesting. No vertical shifting of even columns is done (top and bottom edges are aligned between columns).

Figure 8-24: RepeatDesc/@LayoutStyle = "Reverse2ndColumnAligned"

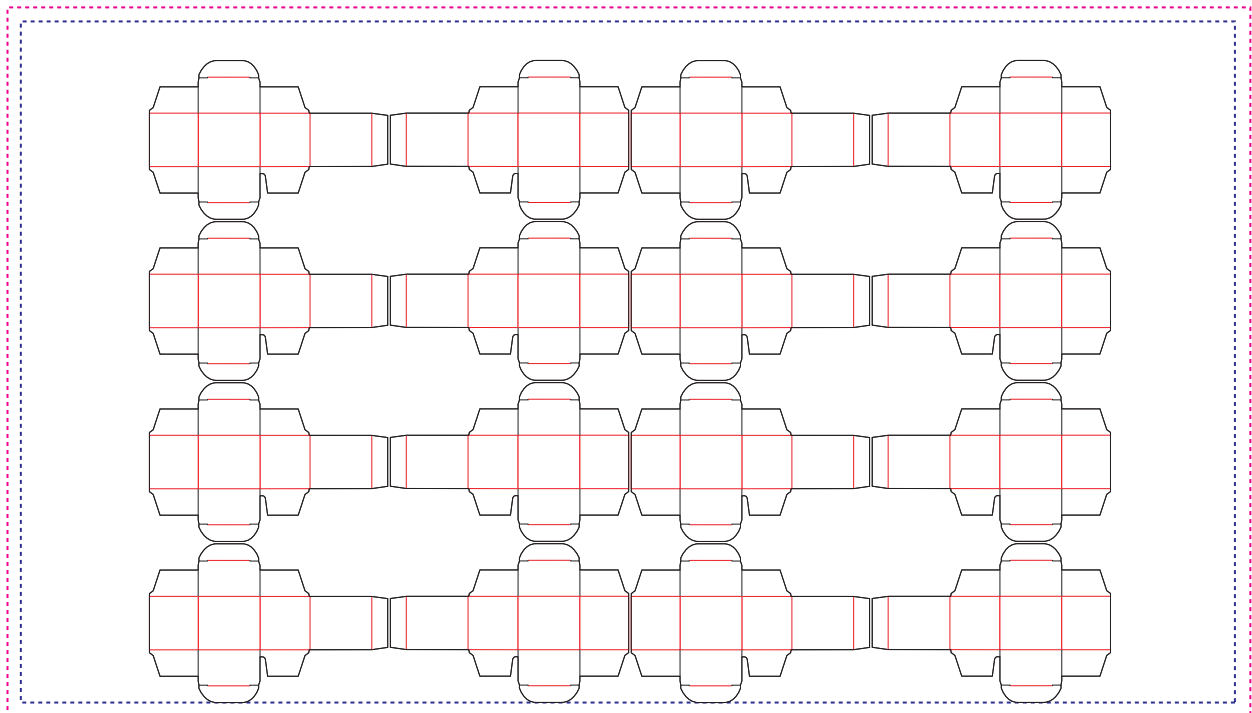

RESOURCES

In the following figure, @LayoutStyle="Reverse2ndRow", @GutterX="36", @GutterX2="70", @GutterY="20", @GutterY2="40".

Figure 8-25: RepeatDesc using Secondary Gutters

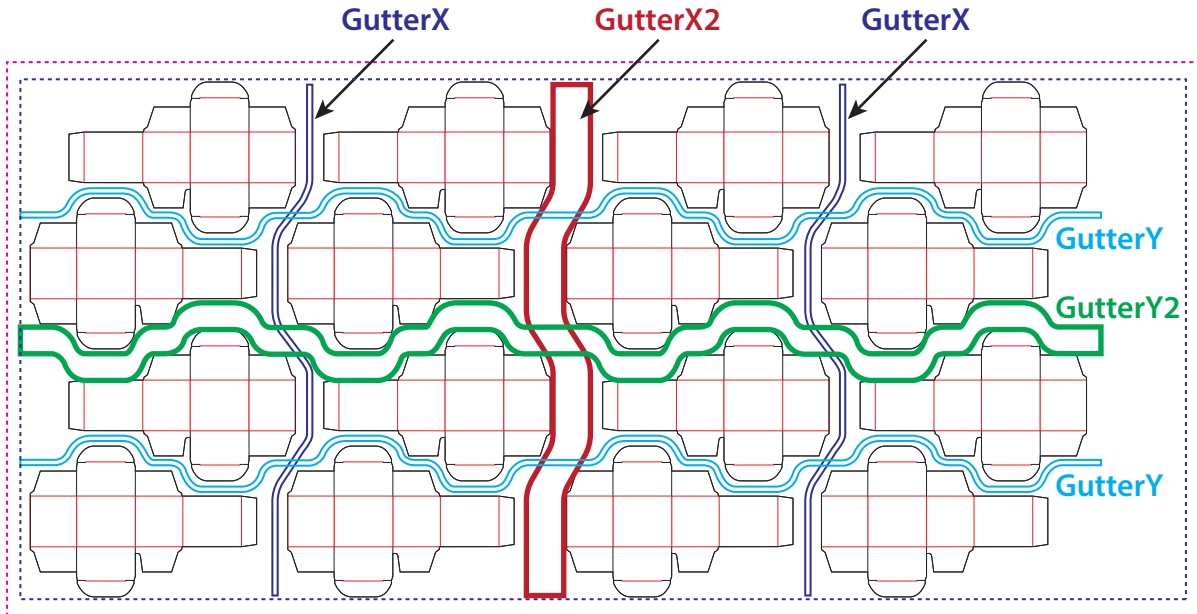

8.47 DigitalDeliveryParams

New in JDF 1.2

DigitalDeliveryParams specifies the parameters of the DigitalDelivery process.

Resource Properties

- Resource Class: Parameter
- Intent Pairing: ArtDeliveryIntent
- Example Partition: "Location"
- Input of Processes: DigitalDelivery

Table 8.78: DigitalDeliveryParams Resource (Sheet 1 of 2)

NAME	DATA TYPE	DESCRIPTION
DigitalDeliveryDirection?	enumeration	Describes which side activates the delivery. Allowed values are: Push – The artwork will be sent (the source end is active). Pull – The artwork will be retrieved (the destination end is active).
DigitalDeliveryProtocol?	NMTOKEN	Identifies the delivery network protocol. Values include: FTP HTTP HTTPS SMTP
Method? Modified in JDF 1.5	NMTOKEN	Identifies the delivery method. Values include: EMail NetworkCopy – This includes LAN and VPN. WebServer – Upload / Download from HTTP / FTP server. InstantMessaging Note: Values also include any brand name of a network provider. New in JDF 1.5

Table 8.78: DigitalDeliveryParams Resource (Sheet 2 of 2)

NAME	DATA TYPE	DESCRIPTION
Contact *	refelement	Source and destination address for the transfer of the artwork. The destination delivery address is specified as the Contact [@ContactTypes="Delivery"]/ComChannel. Exactly one such Contact SHALL be specified per destination. If multiple delivery destinations are specified within one DigitalDelivery process, such a Contact SHALL be partitioned with the partition key "Location". If the output RunList completely specifies the destination, a Contact [@ContactTypes="Delivery"] SHOULD be omitted. This is generally the case if @Method="NetworkCopy" or "WebServer". A Contact [@ContactTypes="Sender"] specifies the source address.

Compression & Encoding of the transferred files:

In order to instruct a digital delivery device to compress or encode the files one can use the input and output **RunList** with **FileSpec**/@Compression attribute, even if no URL is specified.

8.48 DigitalMedia

New in JDF 1.2

DigitalMedia represents processed removable digital media-based **Handling Resource**, such as tape or removable disk.

Resource Properties

Resource Class: Handling

Resource referenced by: **ArtDeliveryIntent**/**ArtDelivery**

Table 8.79: DigitalMedia Resource

NAME	DATA TYPE	DESCRIPTION
Capacity ?	integer	Size of the digital media in megabytes.
MediaLabel ?	string	Electronic label of the media.
MediaType	NMTOKEN	The digital media type. Values include: CD – Recordable compact disc. DAT – DAT tape backup media. DLT – DLT tape backup media. DVD – DVD disc. Exabyte – Exabyte tape backup media. HardDrive – Removable hard drives from a rack. Jaz – Jaz removable disk drive. Optical – Optical removable disk drive. Excluding CDs and DVDs. Tape – Tape backup media. Use only when the explicit tape type is not listed here. Zip – Zip removable disk drive.
MediaTypeDetails ?	string	The digital media type details — could be vendor or model name. For example: "8mm" or "VHS" for tape media.
RunList ?	refelement	Link to the relevant files on the media. The URLs specified in RunList / LayoutElement / FileSpec /@URL SHOULD be relative paths to the media's mount point.

8.49 DigitalPrintingParams

DigitalPrintingParams contains details of the **DigitalPrinting** process. The @PrintingType attribute in this resource defines two types of printing: "SheetFed" and "WebFed". The principal difference between them is the shape of the paper each is equipped to accept. Presses that execute "WebFed" processes use substrates that are continuous and cut after printing is accomplished. Most newspapers are printed on web presses. "SheetFed" printing, on the other hand, accepts pre-cut substrates.

8.49.1 Coordinate systems in DigitalPrinting

New in JDF 1.2

RESOURCES

► Figure 2-11: Press coordinate system used for web printing in ► Section 2.6 Coordinate Systems in JDF defines the coordinate system for **ConventionalPrinting** and **DigitalPrinting**.

Note: The paper feed direction of the idealized process is towards the X-axis, which corresponds to bottom edge first.

Resource Properties

Resource Class: Parameter

Example Partition: "BlockName", "DocRunIndex", "DocSheetIndex", "PartVersion", "Run", "RunIndex", "RunTags", "DocTags", "PageTags", "SetTags", "SheetIndex", "Separation", "SheetName", "Side", "SignatureName", "DocIndex"

Intent Pairing: **VariableIntent**

Input of Processes: **DigitalPrinting**

Table 8.80: DigitalPrintingParams Resource (Sheet 1 of 3)

NAME	DATA TYPE	DESCRIPTION
<i>Collate</i> ? New in JDF 1.1	enumeration	<p>Determines the sequencing of the sheets in the document and the documents in the job when multiple copies of a document or a job are requested as output. Document copies can be requested by specifying RunList/@DocCopies and job copies can be requested by specifying the output Component @Amount.</p> <p>Allowed values are:</p> <p>None – Do not collate sheets in the document or document(s) in the job.</p> <p>Sheet – Collate the sheets in each document; do not collate the documents in the job. The result of "Sheet" and "SheetAndSet" is the same when there is one document in the set. The result of "Sheet" and "SheetSetAndJob" is the same when there is one document in the set and one set in the job.</p> <p>SheetAndSet – Collate the sheets in the document and collate the documents in the set. Do not collate the sets in the job. The result of "SheetAndSet" and "SheetSetAndJob" is the same when there is one set in the job.</p> <p>SheetSetAndJob – Collate the sheets in the document, the documents in the set and the sets in the job.</p> <p>Example: Two documents, A and B, each have two sheets, A1, A2 and B1, B2. The number of document copies requested is one for both documents and the number of job copies requested is three (Component/@Amount="3"). The job contains no document set boundaries.</p> <p>If @Collate="None", the sheet order will be: A1A1A1 A2A2A2 B1B1B1 B2B2B2</p> <p>If @Collate="Sheet", the sheet order will be: A1A2 A1A2 A1A2 B1B2 B1B2 B1B2</p> <p>If @Collate="SheetAndSet" or "SheetSetAndJob", the sheet order will be: A1A2 B1B2 A1A2 B1B2 A1A2 B1B2</p>
<i>DirectProofAmount="0"</i> New in JDF 1.2	integer	<p>If greater than zero (>0), a set of proofs is directly produced, Subsequently an approval might be given by a person (e.g., the customer, foreman or floor manager) shortly after the first final-quality printed sheet is printed. Approval is needed for the actual print run, but not for setup. If the DigitalPrinting process is awaiting approval of a direct proof, the JDF node's @Status is switched to "Suspended" with the @StatusDetails="WaitForApproval".</p>
<i>ManualFeed = "false"</i> New in JDF 1.1	boolean	<p>Indicates whether the media will be fed manually.</p>
<i>NonPrintableMargin Bottom</i> ? New in JDF 1.2	double	<p>The width of the bottom margin measured inward from the edge of the media (before trimming if any) with respect to the idealized process coordinate system of the DigitalPrinting process. The DigitalPrinting process SHALL put marks up to, but not in, the non-printable margin area. The Media's origin is unaffected by @NonPrintableMarginBottom. These margins are independent of the PDL content.</p>
<i>NonPrintableMargin Left</i> ? New in JDF 1.2	double	<p>Same as @NonPrintableMarginBottom except for the left margin.</p>

Table 8.80: DigitalPrintingParams Resource (Sheet 2 of 3)

NAME	DATA TYPE	DESCRIPTION
NonPrintableMargin Right ? New in JDF 1.2	double	Same as @NonPrintableMarginBottom except for the right margin.
NonPrintableMargin Top ? New in JDF 1.2	double	Same as @NonPrintableMarginBottom except for the top margin.
OutputBin ? New in JDF 1.1 Modified in JDF 1.5	NMTOKENS	Specifies the bin or bins to which the finished documents SHALL be output. If multiple values are provided, the output bins SHALL be filled in sequence. See @StackAmount . Values include those from: ▶ Input Tray and Output Bin Names. Modification note: Starting with JDF 1.5 , the data type changes from NMTOKEN to NMTOKENS.
PageDelivery ? New in JDF 1.1	enumeration	Indicates how pages SHALL be delivered to the output bin or finisher. Note: These values refer to the orientation of the entire stack being output from the press, not individual sheets. For example, " SameOrderFaceDown " means that the stack can be picked up and turned over to find the output sheets in the same order as the input RunList with the first page on top facing up. Allowed values are: FanFold – The output is alternating face-up, face down. SameOrderFaceUp – Order as defined by the RunList , with the front sides of the media up and the first sheet on top. SameOrderFaceDown – Order as defined by the RunList , with the front sides of the media down and the first sheet on the bottom. ReverseOrderFaceUp – Sheet order reversed compared to " SameOrderFaceUp ", with the front sides of the media up and the last sheet on top. ReverseOrderFaceDown – Sheet order reversed compared to " SameOrderFaceDown ", with the front sides of the media down and the last sheet on the bottom.
PrintingType ? Modified in JDF 1.2	enumeration	Type of printing machine. Allowed values are: ContinuousFed – connected sheets including fan fold. New in JDF 1.2 SheetFed WebFed
PrintPass ? New in JDF 1.5	enumeration	Defines how many passes are required to lay down all separations. Allowed values are: OneShot – all separations are laid down in one pass; MultiShot – separations are laid down individually in multiple passes.
PrintQuality ? Deprecated in JDF 1.1	enumeration	Indicates how pages are to be delivered to the output bin or finisher. Allowed values are: High – Highest quality available on the printer. Normal – The default quality provided by the printer. Draft – Lowest quality available on the printer Deprecation note: Starting with JDF 1.1 , use InterpretingParams/@PrintQuality
SheetLay ?	enumeration	Lay of input media. Reference edge where paper is placed in feeder. Allowed value is from: ▶ SheetLay .

Table 8.80: DigitalPrintingParams Resource (Sheet 3 of 3)

NAME	DATA TYPE	DESCRIPTION
<p><i>Sides</i> ? New in JDF 1.3 Modified in JDF 1.5</p>	enumeration	<p>Indicates whether the <i>ByteMap</i> SHALL be imaged on one or both sides of the media. If the <i>RunList</i> input to <i>DigitalPrinting</i> is partitioned by <i>@Side</i> (either explicitly or implicitly using the <i>RunList/@SheetSides</i> attribute), then the input <i>RunList</i> provides a binding of front and back surfaces to sheets. If <i>@Sides="OneSidedFront"</i> or <i>"OneSidedBack"</i>, then that binding is ignored and one surface is imaged per sheet. If the <i>RunList (Surface)</i> does not provide the binding of surfaces to sides, then the <i>@Sides</i> attribute specifies the binding to be applied. When a different value for this attribute is encountered, it SHALL force a new sheet. However, when the same value for this attribute is restated for consecutive pages, it is the same as if that restatement were not present.</p> <p>Allowed values are: <i>OneSidedBack</i> New in JDF 1.5 <i>OneSidedFront</i> <i>OneSidedBackFlipX</i> Deprecated in JDF 1.5 <i>OneSidedBackFlipY</i> Deprecated in JDF 1.5 <i>TwoSided</i> New in JDF 1.5 <i>TwoSidedFlipX</i> Deprecated in JDF 1.5 <i>TwoSidedFlipY</i> Deprecated in JDF 1.5</p> <p>Note: Starting with JDF 1.5, the orientation of the front pages relative to back pages SHOULD be completely defined in the explicit or implied imposition <i>Layout</i>.</p>
<p><i>StackAmount</i> ? New in JDF 1.5</p>	integer	Specifies the maximum sheet count before switching to the next stacker in the list of <i>@OutputBin</i> values.
<p><i>ApprovalParams</i> ? New in JDF 1.2</p>	refelement	Details of the direct approval process, when <i>@DirectProofAmount</i> > 0.
<p><i>Component</i> ? New in JDF 1.1</p>	refelement	Describes the preprocessed media to be used. Different <i>Media</i> and/or <i>Component</i> resources MAY be specified in different partition leaves to enable content-driven input <i>Media</i> selection. At most one of <i>Media</i> or <i>Component</i> SHALL be specified per partition.
<p><i>Disjointing</i> ? New in JDF 1.1 Deprecated in JDF 1.6</p>	element	Describes how individual components are separated from one another in the output bin. Deprecation note: Starting with JDF 1.6 , use combined stacking.
<p><i>Ink</i> ? New in JDF 1.3 Deprecated in JDF 1.4</p>	refelement	If present indicates that overcoating SHALL be applied to the surface(s) of printed sheets and specifies the ink to be used for overcoating. Overcoating ink SHALL be applied after imaging colorants have been printed. Note: For selective image-wise overcoating (e.g., spot varnishing) a separate separation utilizing overcoating ink SHALL be specified. Deprecation note: Starting with JDF 1.4 , use the <i>Varnishing</i> process.
<p><i>Media</i> ? New in JDF 1.1</p>	refelement	Describes the media to be used. Different <i>Media</i> and/or <i>Component</i> resources MAY be specified in different partition leaves to enable content driven input <i>Media</i> selection. At most one of <i>Media</i> and <i>Component</i> SHALL be specified per partition.
<p><i>MediaSource</i> ? Deprecated in JDF 1.1</p>	refelement	Describes the media to be used. At most one of <i>MediaSource</i> and <i>Component</i> SHALL be specified. Replaced with <i>Media</i> in JDF 1.1 .

8.50 DividingParams

Deprecated in JDF 1.1.

Since the *Dividing* process has been replaced by *Cutting*, this resource is no longer needed.

8.51 ElementColorParams

New in JDF 1.2

ElementColorParams provides the current state of color management related metadata such as the targeted printing condition that a content element has been prepared for.

Resource Properties

Resource Class: Parameter

Resource referenced by: [ContentList/ContentData](#), [LayoutElement](#), [PageList](#), [PageList/PageData](#)

Table 8.81: ElementColorParams Resource

NAME	DATA TYPE	DESCRIPTION
AutomatedOverPrintParams ?	element	A resource that provides controls for the automated selection of overprinting of black text or graphics.
ColorManagementSystem ?	NMTOKEN	Identifies the preferred ICC color management system to use when performing color transformations on the particular LayoutElement . When specified, this attribute overrides any default selection of a color management system by an application and overrides the “CMM Type” value (bytes 4-7 of an ICC Profile Header) in any of the job related ICC profiles. This string attribute value identifies the manufacturer of the preferred CMM and SHALL match one of the registered four-character ICC CMM type values. Values include those from: <i>ICC Manufacturer’s Signature Registry</i> , see ▶ [ICC.1]. Example values: “ACME” for the Acme Corp. CMM.
ICCOutputProfileUsage ?	enumeration	This attribute specifies the usage of the output intent profile or specified printing condition from the PDL. Allowed values are: PDLActual – The embedded PDL output printing condition defines the actual output intent profile (e.g., the final press output). PDLReference – The embedded PDL output printing condition defines the reference output intent profile (e.g., the press profile for proofing). IgnorePDL – The embedded ICC output profile is incorrect and SHOULD be ignored.
AutomatedOverPrintParams ?	element	A resource that provides controls for the automated selection of overprinting of black text or graphics.
ColorantAlias *	element	Each resource instance specifies a replacement colorant name string to be used instead of one or more named colorant strings found in the Layout resource referenced element. Multiple ColorantAlias elements with identical values of ColorantAlias / @ReplacementColorantName SHALL NOT be specified in the same ElementColorParams resource context.
ColorCorrectionOp * New in JDF 1.5	element	List of ColorCorrectionOp subelements, each of which identifies a type of object and specifies the behavior of the color correction for that type of object.
ColorSpaceConversionOp ?	element	List of ColorSpaceConversionOp subelements, each of which identifies a type of object, defines the source color space for that type of object, and specifies the behavior of the conversion operation for that type of object. If not present, the default conversion behavior is derived from @ColorStandard . ColorSpaceConversionOp / @Operation is ignored in the context of ElementColorParams .
FileSpec (ActualOutputProfile) ?	refelement	A FileSpec resource pointing to an ICC profile that describes the characterization of an actual output target device.
FileSpec (ReferenceOutputProfile) ?	refelement	A FileSpec resource pointing to an ICC profile that describes a reference output print condition behavior that SHALL be simulated as a part of a requested color transformation. This profile corresponds to the output intent contained in a PDF/X file. It SHOULD be a specific implementation of ColorIntent / @ColorStandard .

8.52 EmbossingParams

New in JDF 1.1

[EmbossingParams](#) contains attributes and elements used in executing the **Embossing** process. **Embossing** can also be used to model a foil stamping process.

Resource Properties

Resource Class: Parameter

Intent Pairing: [EmbossingIntent](#)

Example Partition: "BlockName", "RibbonName", "SheetName", "SignatureName", "WebName"

Input of Processes: [Embossing](#)

Table 8.82: EmbossingParams Resource

NAME	DATA TYPE	DESCRIPTION
ModuleIndex ? New in JDF 1.4	integer	Index of the embossing module in a multi-function device such as a printing press. See Module for details. In a combined process, all modules of the device, including press modules, finishing modules and varnishing modules are counted to calculate @ModuleIndex .
Emboss *	element	One Emboss element is specified for each impression.

8.52.1 Emboss

Table 8.83: Emboss Element

NAME	DATA TYPE	DESCRIPTION
Direction Modified in JDF 1.3	enumeration	The direction of the image. Allowed value is from: ▶ EmbossDirection .
EdgeAngle ?	double	The angle of a beveled edge in degrees. Typical values are angles of: 30, 40, 45, 50 or 60 degrees. If @EdgeAngle is specified, @EdgeShape ="Beveled" SHALL be specified.
EdgeShape = "Rounded"	enumeration	The transition between the embossed surface and the surrounding media can be rounded or beveled (angled). Allowed values are: Beveled Rounded
EmbossingType Modified in JDF 1.3	enumeration	Specifies the type of embossing required. Allowed value is from: ▶ EmbossType .
Face ? New in JDF 1.6	enumeration	Position of the embossing on the product. Allowed value is from: ▶ Face .
Height ?	double	The height of the levels. This value specifies the vertical distance between the highest and lowest point of the stamp, regardless of the value of @Direction .
ImageSize ?	XYPair	The size of the bounding box of one single image.
Level ?	enumeration	The level of embossing. Allowed value is from: ▶ EmbossLevel .
Position ?	XYPair	Position of the lower left corner of the bounding box of the embossed image in the coordinate system of the Component .
IdentificationField ? New in JDF 1.4	refelement	If @EmbossingType ="Braille", IdentificationField SHALL describe the content of the Braille element.
Media ? New in JDF 1.4	refelement	If the @EmbossingType ="FoilEmbossing" or "FoilStamping", Media describes the foil.
Tool ? New in JDF 1.4	refelement	The tool used to perform the embossing described by this element.

8.53 Employee

Information about a specific device or machine operator (see ▶ Section 3.8.5.3 ImplementationResource). [Employee](#) is also used to describe the contact person who is responsible for executing a node, as defined in [NodeInfo](#).

Resource Properties

Resource Class: Implementation

Resource referenced by: [Abstract Audit](#), [Notification](#), [PhaseTime](#), [ModulePhase](#), [JMF](#), [Message](#), [DeviceInfo](#), [ModuleStatus](#), [ContentList/ContentData/ContentMetadata](#), [NodeInfo](#)Input of Processes: [Any Process](#)

Table 8.84: Employee Resource

NAME	DATA TYPE	DESCRIPTION
PersonalID ?	string	ID of the relevant MIS employee. The @PersonalID attribute SHALL be unique within the site.
Roles ? New in JDF 1.2 Modified in JDF 1.4	NMTOKENS	Defines the list of roles that the employee fills. Values include: Apprentice – Employee that is in training (“Auszubildender” / “Auszubildende” in German). Assistant – Assistant operator. Craftsman – Trained employee (“Geselle” / “Facharbeiter” in German). CSR – Customer Service Representative Manager – Manager. Master – Highly trained employee (“Meister” in German). Operator – Operator. ShiftLeader – The leader of the shift. StandBy – Employee who is allocated to a specific task on demand. New in JDF 1.4
Shift ?	string	Defines the shift to which the employee belongs.
CostCenter ?	element	MIS cost center ID.
Person ?	element	Describes the employee. If no Person resource is specified, the Employee resource represents any employee who fulfills the selection criteria.

8.54 EndSheetGluingParams

[EndSheetGluingParams](#) describes the attributes and elements used in executing the [EndSheetGluing](#) process.

Resource Properties

Resource Class: Parameter

Intent Pairing: [BindingIntent](#)Input of Processes: [EndSheetGluing](#)

Table 8.85: EndSheetGluingParams Resource

NAME	DATA TYPE	DESCRIPTION
EndSheet (Front) ? Modified in JDF 1.5	element	Information about the front end sheet. The @Side attribute of this element SHALL be “Front”. Modification note: Starting with JDF 1.5 , this element is optional.
EndSheet (Back) ? Modified in JDF 1.5	element	Information about the back end sheet. The @Side attribute of this element SHALL be “Back”. Modification note: Starting with JDF 1.5 , this element is optional.

8.54.1 EndSheet

Table 8.86: EndSheet Element

NAME	DATA TYPE	DESCRIPTION
<i>Offset</i> ? Deprecated in JDF 1.2	XYPair	Offset of end sheet in X and Y direction. In JDF 1.2 and beyond, <i>@Offset</i> is implied by the transformation matrix in ResourceLink/@Transformation of the <i>EndSheet</i> element's ComponentLink .
<i>Side</i>	enumeration	Location of the end sheet. Allowed value is from: ▶ Side
<i>GlueLine</i>	element	Description of the glue line.

Figure 8-26: Parameters and coordinate system used for EndSheetGluing

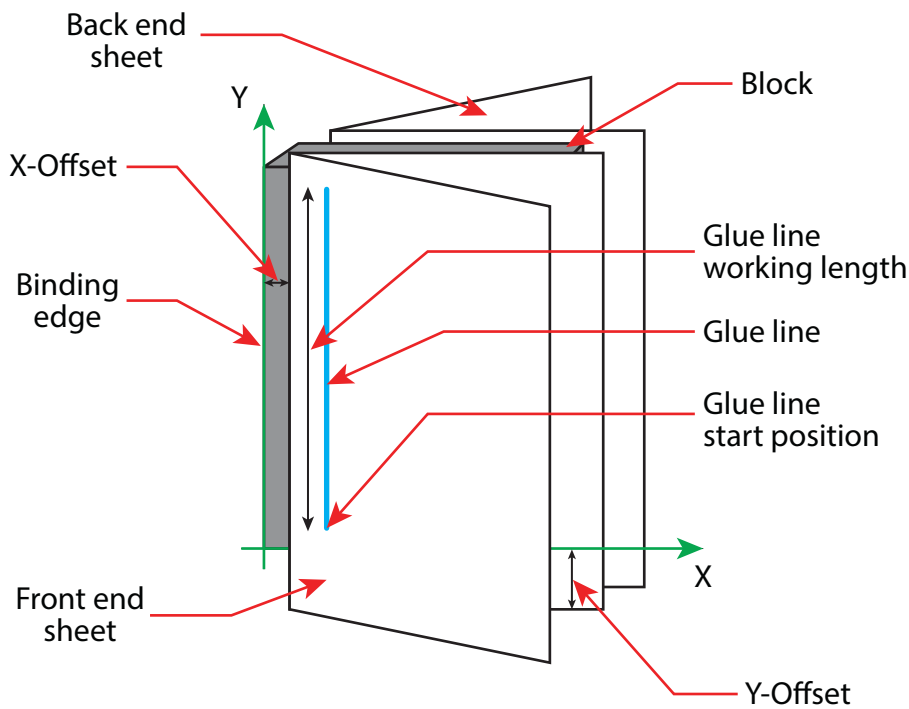

The process coordinate system is defined as follows: The Y-axis is aligned with the binding edge of the book block. It increases from the registered edge to the edge opposite to the registered edge. The X-axis is aligned with the registered edge. It increases from the binding side to the face side opposite the binding side.

8.55 ExposedMedia

ExposedMedia represents processed *Media* based *Handling Resource* such as film, plate or paper proof. It is also used as an input resource for the *Scanning* process. The *@ProductID* attribute SHALL be unique within the workflow.

Resource Properties

- Resource Class: Handling
- Resource referenced by: [ArtDeliveryIntent/ArtDelivery](#)
- Example Partition: "DocIndex", "RunIndex", "RunTags", "DocTags", "PageTags", "SetTags", "Separation", "SheetName", "Side", "SignatureName", "TileID", "WebName"
- Input of Processes: **Bending, ContactCopying, ConventionalPrinting, DigitalPrinting, ImageSetting, PreviewGeneration, Scanning, Varnishing**

Output of Processes: **Bending, ContactCopying, ImageSetting**

Table 8.87: ExposedMedia Resource

NAME	DATA TYPE	DESCRIPTION
ColorType ? New in JDF 1.3	enumeration	If this ExposedMedia represents a proof, @ColorType SHALL specify the color of the proof. Allowed values are: Color GrayScale Monochrome – Black and white.
PageListIndex ? New in JDF 1.3	IntegerRangeList	List of the indices of the PageData elements of the PageList specified in this ExposedMedia .
PlateType ? New in JDF 1.3	enumeration	Specifies whether a plate is exposed or a dummy plate. Allowed values are: Dummy – Specifies a dummy plate that has not been imaged. Usually, dummy plates are only needed on newspaper/web presses or for Varnishing . Exposed – The plate has been imaged.
Polarity = "true"	boolean	"false" if the media contains a negative image.
ProofName ? New in JDF 1.2	string	When this ExposedMedia specifies a proof, @ProofName is the name of the ProofingIntent/ProofItem that specified this proof in the product intent section.
ProofQuality ? Modified in JDF 1.2	enumeration	This attribute is present if the ExposedMedia resource describes a proof. Allowed values are: None – Not a proof or the quality is unknown. Deprecated in JDF 1.2 Halftone – Halftones are emulated. Contone – No halftones, but exact color. Conceptual – Color does not match precisely.
ProofType ? Modified in JDF 1.2	enumeration	Allowed values are: None – Not a proof or the type is unknown. Deprecated in JDF 1.2 Page – A page proof. Imposition – An imposition proof.
PunchType ?	string	Name of the registration punch scheme. See Bending . If not specified, no holes have been punched. Values include: Bacher Stoesser
Resolution ?	XYPair	Resolution of the output.
FileSpec (OutputProfile) ?	reference	A FileSpec resource pointing to an ICC profile that describes the output process for which this media was exposed.
Media	reference	Describes media specifics such as size and type.
PageList ? New in JDF 1.3	reference	Specification of page metadata for pages described by this ExposedMedia .
ScreeningParams ?	reference	Used to describe the screening in case of rasterized media.

8.56 ExternalImpositionTemplate

New in JDF 1.3

[ExternalImpositionTemplate](#) specifies a reference to an external imposition template.

Resource Properties

Resource Class: **Parameter**

RESOURCES

Resource referenced by: [LayoutPreparationParams](#), [StrippingParams](#)

Table 8.88: ExternalImpositionTemplate Resource

NAME	DATA TYPE	DESCRIPTION
FileSpec	reference	A reference to a file that contains an external imposition template in a private (non JDF) format.

8.57 FeedingParams

New in JDF 1.2

The parameters for any **JDF** feeder processing device.

Resource Properties

Resource Class: Parameter

Example Partition: "DocIndex", "RunIndex", "RunTags", "DocTags", "PageTags", "SetTags", "Separation", "SheetName", "Side", "SignatureName", "TileID", "WebName"

Input of Processes: **Feeding**

Table 8.89: FeedingParams Resource

NAME	DATA TYPE	DESCRIPTION
CollatingItem *	element	Defines the collating sequence of the input Component (s). If a CollatingItem is not defined, then one Component in the order of input ResourceLink list is consumed.
Feeder *	element	Defines the specifics of an individual Feeder . If a Component or Media from the input resource list is not referenced from a Feeder in this list, a system defined Feeder will be used.

8.57.1 CollatingItem

Table 8.90: CollatingItem Element (Sheet 1 of 2)

NAME	DATA TYPE	DESCRIPTION
Amount = "1"	integer	Determines how many consecutive items shall be consumed.
BundleDepth ?	integer	In case of nested bundles with @BundleType ="Stack", this parameter addresses the element to be consumed within the "tree" of such bundles. If the real bundle depth level (@BundleType ="Stack") is smaller than the value of @BundleDepth , individual stack items (i.e., the smallest available level) shall be consumed. If the input component referenced does not contain bundles, then this parameter is ignored. A @BundleDepth value of "0" means the Component itself. A value of "1" addresses the BundleItem elements referenced from the Component (i.e., the Component/Bundle/BundleItem/Component (Ref), and so on).
Orientation ?	enumeration	Named orientation of the CollatingItem relative to the input coordinate system. For details see ▶ Table 2.4 Matrices and Orientation values for describing the orientation of a Component. At most one of @Orientation or @Transformation SHALL be specified. If neither is specified, no transformation is applied. The transformation specified here is applied in addition to any orientation/transformation specified in the respective ResourceLink . Allowed value is from: ▶ Orientation.
Transformation ?	matrix	Transformation of the CollatingItem relative to the input coordinate system. For details see ▶ Table 2.4 Matrices and Orientation values for describing the orientation of a Component. At most one of @Orientation or @Transformation SHALL be specified. If neither is specified, no transformation is applied. The transformation specified here is applied in addition to any orientation/transformation specified in the respective ResourceLink .

Table 8.90: CollatingItem Element (Sheet 2 of 2)

NAME	DATA TYPE	DESCRIPTION
<i>TransformationContext</i> = "StackItem"	enumeration	This parameter specifies the object that SHALL be manipulated in orientation/transformation, and it is important to determine the sequence of stack items after flipping. Allowed values are: <i>CollateItem</i> – Apply to a <i>CollatingItem</i> as a whole. <i>Component</i> – Apply to each single element of a <i>CollatingItem</i> individually. <i>StackItem</i> – Apply individually to the smallest element on the stack that can be manipulated individually (e.g., to a single sheet in the case of a stack of sheets). Note: If @Amount="1", <i>Component</i> and <i>CollatingItem</i> are referring to the same object and, therefore, result in the same output.
<i>Component</i> ?	reference	References one of the input components to the process to be (partially) consumed by the <i>CollatingItem</i> element. This <i>Component</i> SHALL be an input of the <i>Feeding</i> process. Exactly one of <i>Component</i> or <i>Media</i> SHALL be specified.
<i>Media</i> ?	reference	References one of the input media to the process to be consumed by the <i>CollatingItem</i> element. This <i>Media</i> SHALL be an input of the <i>Feeding</i> process. Exactly one of <i>Component</i> or <i>Media</i> SHALL be specified.

Note: Most real world devices process stack items one by one, and hence will hardly ever support @TransformationContext="CollateItem". This requires some kind of buffer for the stack items belonging to a single collating item, and a flipping mechanism for the *PrintRolling* process.

8.57.2 Feeder

Table 8.91: Feeder Element (Sheet 1 of 2)

NAME	DATA TYPE	DESCRIPTION
<i>AlternatePositions</i> ?	IntegerList	Positions of alternate feeders including the feeder specified in @Position on a feeding chain. Alternate feeders share the load according to the policy defined in @FeederSynchronization. If not specified, it defaults to the value of @Position. @AlternatePositions SHALL be non-negative.
<i>FeederSynchronization</i> = "Primary"	enumeration	Specifies the synchronization of multiple <i>Feeder</i> elements with identical <i>Component</i> elements. Allowed values are: <i>Alternate</i> – The feeders specified in @Position SHALL alternate. <i>Backup</i> – This feeder is the backup feeder for the <i>Component</i> in case of a mis-feed or malfunction. The priority of backup feeders SHALL be defined by their position in @AlternatePositions. <i>Chain</i> – This feeder is activated as soon as the feeder prior to it in the list is empty. <i>Primary</i> – This feeder is the primary feeder for the <i>Component</i> .
<i>FeederType</i> ? Modified in JDF 1.4 Modified in JDF 1.5	NMTOKEN	Specifies the feeder type. Values include: <i>AddOn</i> – Add on feeder (e.g., CDs). <i>BookBlock</i> – A feeder for book blocks. New in JDF 1.4 <i>Folding</i> – A folding feeder that folds the input <i>Component</i> or <i>Media</i> . <i>Gluing</i> – A gluing feeder. <i>Roll</i> – Roll feeder for web processes. These are also known as unwinders. New in JDF 1.5 <i>Sheet</i> – Single sheet feeder. <i>Signature</i> – Single signature feeder.

Table 8.91: Feeder Element (Sheet 2 of 2)

NAME	DATA TYPE	DESCRIPTION
<i>Loading</i> ?	NMTOKEN	Specifies the feeder loading. Values include: Bundle – Stream feeder, using the output of the Bundling process. FanFold – Automatic loading of fan fold media. Manual – Manual loading of stacks. Online – Loaded by a gripper or conveyor. The "Online" value is also applicable for @FeederType="Roll" . PrintRoll – Automatic loading of single products from a print roll, using the output of the PrintRolling process.
<i>Opening = "None"</i>	enumeration	Specifies the opening of signatures. Allowed values are: Back – Overfold on back. Front – Overfold on front. None – Signatures are not opened. Sucker – Sucker opening, no overfold is required.
<i>Position</i> ?	integer	@Position of feeder on a collecting and gathering chain in chain movement direction. @Position="0" is first feeder feeding to the collecting and gathering chain. Only one Feeder SHALL be specified for any given @Position . If @Position is negative, it specifies the position counted from the back of the chain (e.g., "-1" = last position, "-2" = next to last position, etc.).
<i>Component</i> ?	refelement	Specifies the Component that SHALL be loaded into this Feeder . This Component SHALL be an input of the Feeding process. Exactly one of Component or Media SHALL be specified.
<i>FeederQualityParams</i> ?	element	Definition of the setup and policy for feeding quality.
<i>Media</i> ?	refelement	Specifies the Media that SHALL be loaded into this Feeder . This Media SHALL be an input of the Feeding process. Exactly one of Component or Media SHALL be specified.

8.57.3 FeederQualityParams

The **FeederQualityParams** element defines the setup and policy for feeding quality control. It is specified individually for each **Feeder**.

Table 8.92: FeederQualityParams Element

NAME	DATA TYPE	DESCRIPTION
<i>BadFeedQuality</i> ?	enumeration	Defines the operation of the bad feed quality control. Allowed value is from: ▶ FeedQuality.
<i>BadFeeds</i> ?	integer	Number of consecutive bad feeds until the device SHALL stop.
<i>DoubleFeedQuality</i> ?	enumeration	Defines the operation of the double feed quality control. Allowed value is from: ▶ FeedQuality.
<i>DoubleFeeds</i> ?	integer	Number of consecutive double feeds until the device SHALL stop.
<i>IncorrectComponentQuality</i> ?	enumeration	Defines the operation of the incorrect components quality control. Allowed value is from: ▶ FeedQuality.
<i>IncorrectComponents</i> ?	integer	Number of consecutive incorrect components until the device SHALL stop.

8.58 FileSpec

Specification of a file or a set of files. If a single **FileSpec** instance specifies a set of files, it SHALL do so using the **@FileFormat** and **@FileTemplate** attributes to specify a sequence of URLs. Otherwise, each **FileSpec** instance specifies a single file. If that single file is inside a container file (e.g., a zip file or is compressed or encoded as indicated by **@Compression**), the **FileSpec** instance SHALL define a **Container** subelement which, in turn, defines another **FileSpec** in-

stance specifying the container file. In such a case, the attributes of each **FileSpec** instance SHALL apply only to the properties of the file at that level.

Resource Properties

Resource Class: Parameter

Resource referenced by: [ApprovalSuccess/ApprovalDetails](#), [AssetListCreationParams](#), [ByteMap](#), [Color](#), [Color/FileSpec](#), [ColorCorrectionParams](#), [ColorCorrectionParams/ColorCorrectionOp](#), [ColorSpaceConversionOp](#), [ColorSpaceConversionParams](#), [DBMergeParams](#), [Device/IconList/Icon](#), [DieLayout](#), [ElementColorParams](#), [ExposedMedia](#), [ExternallImpositionTemplate](#), [FileSpec/Container](#), [FileSpec/FileAlias](#), [FormatConversionParams/TIFFFormatParams/TIFFEmbeddedFile](#), [ImageReplacementParams](#), [LayoutElement](#), [LayoutElementProductionParams](#), [PDLResourceAlias](#), [QualityControlResult](#), [ScanParams](#), [ShapeDef](#), [ShapeDefProductionParams/ObjectModel](#), [ShapeDefProductionParams/ShapeTemplate](#)

Example Partition: "Separation"

Table 8.93: FileSpec Resource (Sheet 1 of 5)

NAME	DATA TYPE	DESCRIPTION
Application ?	string	Creator application. See @AppVersion for the application version number.
AppOS ? Modified in JDF 1.2 Deprecated in JDF 1.6	string	Operating system of the application that created the file. Values include: DG_UX HP_UX IRIX Linux Mac Solaris Windows Note: Additional values can be used from the IANA Operating System Names ▶ [IANA-os] which allows up to 40 uppercase US ASCII alphabetical values as well as "-", "_", and "/" — but only for values not covered by the above values. For example, "OS/2". See ▶ Appendix L AppOS and OSVersion Attributes for combinations of @AppOS and @OSVersion values.
AppVersion ?	string	Version of the value of the @Application attribute. Examples are: "8.1" "8.1 (4331)" "9.0.3 SR3437"
Checksum ? New in JDF 1.1 Modified in JDF 1.1A	hexBinary	Checksum of the file being referenced using the RSA MD5 algorithm. In JDF 1.1A, the term RSA MD was extended to RSA MD5. The data type was modified to hexBinary to accommodate the 128 bit output of the MD5 algorithm. The @Checksum SHALL be for the entire file, not just parts of the file.

Table 8.93: FileSpec Resource (Sheet 2 of 5)

NAME	DATA TYPE	DESCRIPTION
<p><i>Compression</i>="None" Modified in JDF 1.2</p>	<p>NMTOKEN</p>	<p>Indicates the compression or encoding for the entire file. This is not compression used internally within the file.</p> <p>Values include:</p> <p>Base64 – A format for encoding arbitrary binary information for transmission by electronic mail. ▶ [RFC4648]</p> <p>BinHex – BinHex encoding converts an 8-bit file into a 7-bit format, similar to Uuencoding ▶ [RFC1741].</p> <p>Compress – UNIX compression ▶ [RFC1977].</p> <p>Deflate – The file is compressed using zip public domain compression format ▶ [RFC1951].</p> <p>Gzip – GNU zip compression technology ▶ [RFC1952].</p> <p>MacBinary – A format that combines the two forks of a Mac file, together with the file information, into a single binary data stream suitable for storage or transferring through non-Mac systems. ▶ [macbinary]</p> <p>None – The file is neither compressed nor encoded.</p> <p>UUEncode – A set of algorithms for converting files into a series of 7-bit ASCII characters that can be transmitted over the internet. ▶ [uuencode]</p> <p>ZLIB – ZLIB compression ▶ [RFC1950].</p>
<p><i>Disposition</i> ? Deprecated in JDF 1.2</p>	<p>enumeration</p>	<p>Indicates what the device SHALL do with the file when the process that uses this resource as an input resource completes.</p> <p>Allowed values are:</p> <p>Unlink – The device SHALL release the file.</p> <p>Delete – The device SHALL attempt to delete the file.</p> <p>Retain – The device SHALL do nothing with the file.</p> <p>Deprecation note: Starting with JDF 1.2, retention of assets is specified in the <i>Disposition</i> resource.</p>
<p><i>DocumentNaturalLanguage</i> ?</p>	<p>language</p>	<p>The natural language of the document this <i>FileSpec</i> refers to. If the document contains more than one language, the value is the primary language of the document.</p>
<p><i>Encoding</i> ? New in JDF 1.4</p>	<p>string</p>	<p>Encoding or code page of the file contents.</p> <p>Values include those from: IANA Character Set Names see ▶ [iana-character sets].</p>
<p><i>FileFormat</i> ?</p>	<p>string</p>	<p>A formatting string used with the <i>@FileTemplate</i> attribute to define a sequence of URLs in a batch process, each of which has the same semantics as the <i>@URL</i> attribute.</p> <p>Allowed values are from: ▶ Appendix H String Generation.</p> <p>Constraint: If neither <i>@URL</i> nor <i>@UID</i> is present, both <i>@FileFormat</i> and <i>@FileTemplate</i> SHALL be present, unless the resource is a pipe. If either <i>@URL</i> or <i>@UID</i> is specified, then <i>@FileFormat</i> and <i>@FileTemplate</i> SHALL NOT be specified.</p>
<p><i>FileSize</i> ? Modified in JDF 1.2</p>	<p>LongInteger</p>	<p>Size of the file in bytes. The data type was changed from integer to LongInteger in JDF 1.2.</p>
<p><i>FileTargetDeviceModel</i> ? New in JDF 1.2</p>	<p>string</p>	<p>Identifies the model of the JDF device for which the document was formatted, including manufacturer name, when the file is device-dependent.</p> <p>Default behavior: the file is device independent</p> <p>Value format is from: IEEE 1284-2000 device ID string.</p> <p>Note: The value of this attribute SHALL exactly match the IEEE 1284-2000 device ID string, except the length field SHALL NOT be specified. See the Microsoft Universal Plug-and-Play ▶ [UPNP] section 2.2.6 <i>DeviceId</i> parameter for details.</p> <p>Example: It shows only the REQUIRED fields for a PostScript document formatted for a <i>LaserBeam 9</i>: MANUFACTURER:ACME Co.;COMMAND SET:PS;MODEL:LaserBeam 9; (See ▶ [IEEE1284] clause 7.6).</p>

Table 8.93: FileSpec Resource (Sheet 3 of 5)

NAME	DATA TYPE	DESCRIPTION
<i>FileTemplate</i> ?	string	A template, used with <i>@FileFormat</i> , to define a sequence of URLs in a batch process, each of which has the same semantics as the <i>@URL</i> attribute. Constraint: If neither <i>@URL</i> nor <i>@UID</i> is present, both <i>@FileFormat</i> and <i>@FileTemplate</i> SHALL be present, unless the resource is a pipe. Allowed values are from: ▶ Appendix H String Generation.
<i>FileVersion</i> ? New in JDF 1.1	string	Version of the file referenced by this <i>FileSpec</i> .
<i>MimeType</i> ? Modified in JDF 1.2	string	MIME type or file type of the file (or files of identical type when specifying a sequence of file names using the <i>@FileFormat</i> and <i>@FileTemplate</i> attributes). See <i>@Compression</i> for the indication of compression or encoding of the file. See <i>@MimeTypeVersion</i> for the format version. If the file format has a MIME Media Type registered with IANA, see ▶ [IANA-mt], that value SHALL be used. Note: That ▶ [RFC2046] stipulates that MIME Media Types are case-insensitive. If the file format does not have a MIME Media Type registered with IANA, then the JDF specification defines string values, known as file types, which SHALL be used. Values include those from: ▶ Appendix G MimeTypes.
<i>MimeTypeVersion</i> ? New in JDF 1.2	string	The level or version of the file format identified by <i>@MimeType</i> , whether the value of <i>@MimeType</i> is a MIME Media Type or a file type value defined by the JDF spec. Example values include: "PDF/1.3", "PDF/1.4" and "PDF/X-1a:2001" for <i>@MimeType</i> ="application/pdf" "TIFF-IT/FP:1998", "TIFF-IT/CT:1998" and "TIFF-IT/LW/P1:1998" for <i>@MimeType</i> ="TIFF/IT" Values include those from: ▶ Appendix G MimeTypes.
<i>OSVersion</i> ? Modified in JDF 1.2 Deprecated in JDF 1.6	string	Version of the operating system specified by <i>@AppOS</i> . The IANA Registry provides a list. Values include those from: ▶ Table L.2 AppOS and OSVersion Examples.
<i>OverwritePolicy</i> ? New in JDF 1.2	enumeration	Policy that specifies the policy to follow when a file already exists and the <i>FileSpec</i> is used as an output resource. Allowed values are: <i>Overwrite</i> – Overwrite the old file. <i>RenameNew</i> – Rename the new file. <i>RenameOld</i> – Rename the old file. <i>NewVersion</i> – Create a new file version. Only valid when the <i>FileSpec</i> references a file on a version aware file system. <i>OperatorIntervention</i> – Present a dialog to an operator. <i>Abort</i> – Abort the process without modifying the old file.
<i>PageOrder</i> ?	enumeration	Indicates the order of pages in the file containing pages. Allowed values are: <i>Ascending</i> – The first page in the file is the lowest numbered page. <i>Descending</i> – The first page in the file is the highest numbered page.
<i>Password</i> ? New in JDF 1.3	string	Password or decryption key that is needed to read the file contents. Note: Since this password string is not encrypted, it SHOULD only be passed around within a protected environment.

Table 8.93: FileSpec Resource (Sheet 4 of 5)

NAME	DATA TYPE	DESCRIPTION
<p><i>RequestQuality</i> ? New in JDF 1.3</p>	<p>double</p>	<p><i>@RequestQuality</i> specifies a requested quality of the encoded data when reading image data with selected <i>@MimeType</i> values which support variable quality. <i>@RequestQuality</i> is ignored when the <i>FileSpec</i> is referenced from an output resource or the <i>FileSpec</i> does not reference image data which support variable quality.</p> <p>The value in the range of 0.0 to 1.0 represents a factor of the maximum quality encoded in the file. If left unspecified, the value defaults to 1.0, meaning all information encoded will be returned. The following details how values are interpreted for the supported <i>@MimeType</i> values:</p> <p>"image/jp2", "image/jpx" – The value represents the ratio of the encoding bitrate of the maximum bitrate layer encoded in the file.</p> <p>"image/gif" – The number represents a ratio of the total interleaved layers of the file.</p> <p>Note: Only interleaved GIF.</p> <p>"image/tiff" – The number represents the ratio of the total resolution of the complete image.</p> <p>Note: Only pyramid TIFF.</p>
<p><i>ResourceUsage</i> ?</p>	<p>NMTOKEN</p>	<p>If an element uses more than one <i>FileSpec</i> subelement, this attribute is used to refer from the parent element to a certain child element of this type, for example, see <i>FormatConversionParams</i>.</p> <p>Values include those from: ▶ Table 8.94 ResourceUsage Attribute Values.</p>
<p><i>SearchDepth</i> ? New in JDF 1.2</p>	<p>integer</p>	<p>Used when <i>@ResourceUsage</i>="SearchPath" to specify the maximum directory depth that will be recursively searched. 0 specifies this directory only, "INF" specifies an unlimited search.</p>
<p><i>UID</i> ? New in JDF 1.1</p>	<p>string</p>	<p>Internal ID of the referenced file. The <i>@UID</i> SHALL be unique within the workflow. This attribute is dependent on the type of file that is referenced:</p> <p>Values include:</p> <p>PDF – Variable unique identifier in the ID field of the PDF file's trailer.</p> <p>ICC Profile – The profile ID in bytes 84-99 of the ICC profile header.</p> <p>Others – Format specific.</p> <p>Constraint: If neither <i>@URL</i> nor <i>@UID</i> is present on an input <i>FileSpec</i>, and neither <i>@FileFormat</i> nor <i>@FileTemplate</i> is present, the referencing resource SHALL be a pipe. If either <i>@URL</i> or <i>@UID</i> is specified, then <i>@FileFormat</i> and <i>@FileTemplate</i> SHALL NOT be specified.</p>
<p><i>URL</i> ?</p>	<p>URL</p>	<p>Location of the file specified as either an absolute URI or a relative URI. If neither <i>@URL</i> nor <i>@UID</i> is present on an input <i>FileSpec</i>, and neither <i>@FileFormat</i> nor <i>@FileTemplate</i> is present, the referencing resource SHALL be a pipe. If either <i>@URL</i> or <i>@UID</i> is specified, then <i>@FileFormat</i> and <i>@FileTemplate</i> SHALL NOT be specified.</p> <p>If <i>@URL</i> is not specified in an output resource, the system-specified location will be assumed, but this value SHALL be updated as soon as the output resource is available. For example, an instruction for a digital delivery JDF device to compress the files MAY specify the output <i>RunList</i> with the <i>@Compression</i> attribute without the <i>@URL</i> attribute.</p> <p>See ▶ [RFC3986] and ▶ Appendix J Resolving Directory URL References and ▶ Appendix L FileSpec Use Cases for the syntax and examples. For the "file" URL scheme see also ▶ [RFC1738] and ▶ [FileURL].</p>
<p><i>UserFileName</i> ?</p>	<p>string</p>	<p>A user-friendly name which can be used to identify the file.</p> <p>MAY be used by an agent to identify a file on a device without knowing the file's internal location.</p>
<p><i>Container</i> ? New in JDF 1.2</p>	<p>refelement</p>	<p>Specifies the container for this file. When a container <i>FileSpec</i> is pointed to by <i>Container</i>, that <i>FileSpec</i> SHALL NOT also specify <i>@FileFormat</i> and <i>@FileTemplate</i> attributes.</p> <p>The container mechanism MAY be used recursively (e.g., for a zip file held in a tar file, a zip file in a zip file, an encoded zip file, etc.). See ▶ Appendix J Resolving Directory URL References for details.</p>

Table 8.93: FileSpec Resource (Sheet 5 of 5)

NAME	DATA TYPE	DESCRIPTION
Disposition ? New in JDF 1.2	element	Indicates what the device SHOULD do with the file when the process that uses this resource completes. If not specified here or in the parent RunList , the file specified by this FileSpec SHOULD NOT be deleted by the device. If FileSpec/Disposition is specified, it takes precedence over RunList/Disposition .
FileAlias *	element	Defines a set of mappings between file names that can occur in the document and URLs (which can refer to external files or parts of a MIME message).

Table 8.94: ResourceUsage Attribute Values

VALUE	DESCRIPTION
AbstractProfile	Used for ColorCorrectionOp/FileSpec and ColorSpaceConversionOp/FileSpec
ActualOutputProfile	Used for ElementColorParams/FileSpec
ColorProfile	Used in Color/FileSpec
CorrectionProfile	Used for ScanParams/FileSpec
DeviceLinkProfile	Used for ColorCorrectionOp/FileSpec and ColorSpaceConversionOp /FileSpec .
FinalTargetDevice	Used for ColorCorrectionParams/FileSpec and ColorSpaceConversionParams/FileSpec
InputFormat	Used for FormatConversionParams/FileSpec
OutputFormat	Used for FormatConversionParams/FileSpec
OutputProfile	Used for ExposedMedia/FileSpec
RasterFileLocation	Used for ByteMap/FileSpec
ReferenceOutputProfile	Used for ElementColorParams/FileSpec
ScanProfile	Used for ScanParams/FileSpec
SearchPath	Used for AssetListCreationParams/FileSpec and ImageReplacementParams/FileSpec .
SourceProfile	Used for ColorSpaceConversionOp/FileSpec
TargetProfile	Used for Color/FileSpec , Color/PrintConditionColor/FileSpec , ScanParams/FileSpec .
WorkingColorSpace	Used for ColorCorrectionParams/FileSpec and ColorSpaceConversionParams/FileSpec

8.58.1 Container

New in JDF 1.2

The **Container** specifies the containing file for a **FileSpec** (e.g., a zip file or tar archive). The **Container** elements MAY be specified recursively in their respective child **FileSpec** elements.

Table 8.95: Container Element

NAME	DATA TYPE	DESCRIPTION
FileSpec	refelement	Link to another FileSpec resource that describes the container (e.g., a packaging file, such as zip, Multipart/Related, tar file or an otherwise compressed or encoded file that contains the file represented by this FileSpec resource). The link value is only to be used for locating that container FileSpec resource. See ▶ Appendix J Resolving Directory URL References for details.

8.58.2 FileAlias

Table 8.96: FileAlias Element

NAME	DATA TYPE	DESCRIPTION
<i>Alias</i>	string	The filename which is expected to occur in the file.
<i>Disposition</i> ? Deprecated in JDF 1.2	enumeration	Indicates what the device SHALL do with the file referenced by this alias when the process that uses this resource as an input resource completes. Allowed values are: Unlink – The device SHALL release the file. Delete – The device SHALL attempt to delete the file. Retain – The device SHALL do nothing with the file. Deprecation note: Starting with JDF 1.2 , use FileSpec/Disposition .
<i>MimeType</i> ? Deprecated in JDF 1.2	string	MIME type of the file. Deprecation note: Starting with JDF/1.2 , use FileSpec/@MimeType .
<i>RawAlias</i> ? New in JDF 1.2	hexBinary	Representation of the original 8-bit byte stream of the alias name. Used to transport the original byte representation of an alias name when moving JDF tickets between computers with different locales.
<i>URL</i> ? Deprecated in JDF 1.2	URL	The URL which identifies the file the alias refers to. In JDF/1.2 and beyond, use FileSpec/@URL .
<i>FileSpec</i> ? New in JDF 1.2	refelement	For JDF version 1.2 and beyond, FileSpec SHALL be present, and SHALL contain a @URL attribute. FileSpec MAY contain additional properties of the file (e.g., Disposition , @MimeType , @MimeTypeVersion , etc.).

8.59 FoldingParams

FoldingParams describes the folding parameters, including the sequence of folding steps. It is also possible to execute the predefined steps of the folding catalog. After each folding step of a folding procedure, the origin of the coordinate system SHALL be moved to the lower left corner of the intermediate folding product. For details see ▶ Section 2.6.5 Product Example: Simple Brochure.

The specification of **@SheetLay** and reference edges (i.e., "Front", "Rear", "Left" and "Right") for the description of an operation (e.g., the positioning of a tool) is done by means of determined names as shown in ▶ Figure 8-27: Names of the reference edges of a sheet in the **FoldingParams** resource below.

Figure 8-27: Names of the reference edges of a sheet in the **FoldingParams** resource

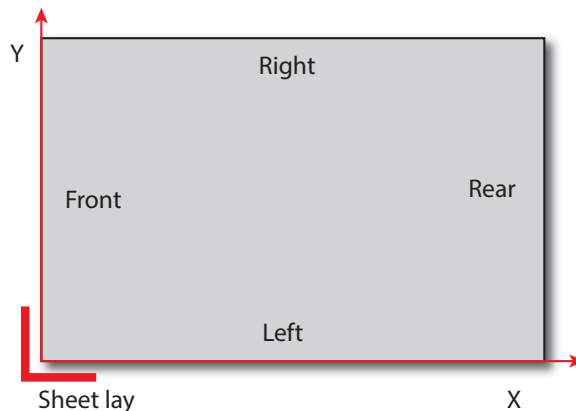

Resource Properties

Resource Class:

Parameter

Intent Pairing:

FoldingIntent

Example Partition:

"BlockName", "RibbonName", "SheetName", "SignatureName", "WebName"

Input of Processes: **Folding**

Table 8.97: FoldingParams Resource

NAME	DATA TYPE	DESCRIPTION
<i>DescriptionType</i> ? Deprecated in JDF 1.2	enumeration	How the folding operations are described. Allowed values are: <i>FoldProc</i> – Detailed description of each individual fold. <i>FoldCatalog</i> – Selection of fold procedure from ▶ Fold Catalog. Deprecation note: Starting with JDF 1.2 , <i>@FoldCatalog</i> defines the topology of the folding scheme. The specifics of each individual fold can be described using <i>Fold</i> elements. If both <i>@FoldCatalog</i> and <i>Fold</i> are specified, <i>Fold</i> takes precedence
<i>FoldCatalog</i> ? Modified in JDF 1.4	string	Describes the type of fold. Values include those from: ▶ Fold Catalog.
<i>FoldingDetails</i> ? New in JDF 1.6	NMTOKEN	<i>@FoldingDetails</i> is a system dependent descriptor of the folding. <i>@FoldingDetails</i> MAY be used to differentiate differing fold dimensions with the same general topology.
<i>FoldSheetIn</i> ? Deprecated in JDF 1.1	XYPair	Input sheet format. If the specified size does not match the size of the X and Y dimensions of the input <i>Component</i> , all coordinates of the folding procedure are scaled accordingly. The scaling factors in the X and Y directions MAY differ. Implementation Note: This attribute SHOULD always match the <i>@Size</i> attribute of the input <i>Component</i> , which is the default.
<i>SheetLay</i> = "Left"	enumeration	Lay of input media. Allowed value is from: ▶ SheetLay. Note: <i>@SheetLay</i> does not modify the coordinate references of the Folding process.
<i>FileSpec</i> (CIP3) ? New in JDF 1.5	reference	Reference to a CIP3 file that contains folding instructions in the ▶ [CIP3 – PPF] format.
<i>Fold</i> * New in JDF 1.1	element	Describes the folding operations in the sequence in which they are to be carried out. It is RECOMMENDED to specify a set of subsequent <i>Fold</i> operations as multiple <i>Fold</i> elements in one Folding procedure, rather than specifying a combined process that combines multiple Folding processes. If both <i>@FoldCatalog</i> and <i>Fold</i> elements are specified, the <i>Fold</i> elements have precedence, and the <i>@FoldCatalog</i> specifies only the topology. For instance, a cover-fold with a page size ratio of 0.52 to 0.48 would still be defined as an "F4-1".
<i>FoldOperation</i> * Deprecated in JDF 1.1	element	Abstract element that describes the folding operations in the sequence in which they are to be carried out. Replaced by the explicit <i>Fold</i> element in JDF 1.1 and beyond.

8.60 FontParams

FontParams describes how fonts are handled when converting PostScript or other PDL files to PDF.

Resource Properties

Resource Class: Parameter

Example Partition: "DocIndex", "RunIndex", "RunTags", "DocTags", "PageTags", "SetTags", "SheetName", "Side", "SignatureName"

Input of Processes: **PSToPDFConversion**

Table 8.98: FontParams Resource (Sheet 1 of 2)

NAME	DATA TYPE	DESCRIPTION
<i>AlwaysEmbed</i> ?	NMTOKENS	One or more names of fonts that are always to be embedded in the PDF file. Each name SHALL be the PostScript language name of the font. An entry that occurs in both the <i>@AlwaysEmbed</i> and <i>@NeverEmbed</i> lists constitutes an error.

Table 8.98: FontParams Resource (Sheet 2 of 2)

NAME	DATA TYPE	DESCRIPTION
<i>CannotEmbedFontPolicy</i> ="Warning"	enumeration	Determines what occurs when a font cannot be embedded. Allowed values are: Error – Log an error and abort the process if any font can not be found or embedded. Warning – Warn and continue if any font cannot be found or embedded. OK – Continue without warning or error if any font can not be found or embedded.
<i>EmbedAllFonts</i> ="false"	boolean	If "true", specifies that all fonts, except those in the <i>@NeverEmbed</i> list, are to be embedded in the PDF file.
<i>MaxSubsetPct</i> ?	integer	The maximum percentage of glyphs in a font that can be used before the entire font is embedded instead of a subset. This value is only used if <i>@SubsetFonts</i> ="true".
<i>NeverEmbed</i> ?	NMTOKENS	One or more names of fonts that are never to be embedded in the PDF file. Each name SHALL be the PostScript language name of the font. An entry that occurs in both the <i>@AlwaysEmbed</i> and <i>@NeverEmbed</i> lists constitutes an error.
<i>SubsetFonts</i> ?	boolean	If "true", font subsetting is enabled. If "false", it is not. Font subsetting embeds only those glyphs that are used, instead of the entire font. This reduces the size of a PDF file that contains embedded fonts. If font subsetting is enabled, the decision whether to embed the entire font or a subset is determined by number of glyphs in the font that are used and the value of <i>@MaxSubsetPct</i> . Note: Embedded instances of multiple master fonts are always subsetted, regardless of the setting of <i>@SubsetFonts</i> .

8.61 FontPolicy

FontPolicy defines the policies that devices SHALL follow when font errors occur while PDL files are being processed. When fonts are referenced by PDL files but are not provided, devices SHALL provide one of the following two fallback behaviors:

- 1 The device provides a standard default font that is substituted whenever a font cannot be found.
- 2 The device provides an emulation of the missing font.

If neither fallback behavior is requested (i.e., both *@UseDefaultFont* and *@UseFontEmulation* are "false"), then the process SHALL fail if a referenced font is not provided. The **FontPolicy** allows jobs to specify whether either of these fallback behaviors are to be employed when missing fonts occur.

Resource Properties

Resource Class: Parameter

Example Partition: "DocIndex", "RunIndex", "RunTags", "DocTags", "PageTags", "SetTags", "SheetName", "Side", "SignatureName"

Input of Processes: Interpreting, Trapping

Table 8.99: FontPolicy Resource

NAME	DATA TYPE	DESCRIPTION
<i>PreferredFont</i>	NMTOKEN	The name of a font that SHALL be used as the default font for this job. It is not an error if the device cannot use the specified font as its default font.
<i>UseDefaultFont</i>	boolean	If "true", the device SHALL resort to a default font if a font cannot be found. Note: This is the normal behavior of the PostScript interpreter, which defaults to Courier when a font cannot be found.
<i>UseFontEmulation</i>	boolean	If "true", the device SHALL emulate a requested font if a font cannot be found.

8.62 FormatConversionParams

New in JDF 1.1

Deprecated in JDF 1.5

For [TIFFFormatParams](#), see . ▶ Section 8.126.2 TIFFFormatParams.

8.63 GatheringParams

[GatheringParams](#) contains the attributes of the [Gathering](#) process.

Resource Properties

Resource Class: Parameter

Input of Processes: [Gathering](#)

Table 8.100: [GatheringParams](#) Resource

NAME	DATA TYPE	DESCRIPTION
Disjointing ? Deprecated in JDF 1.6	element	Description of the separation properties between individual components on a gathered pile. The default case is that no physical separation between components is used and this element is omitted. Deprecation note: Starting with JDF 1.6 , use a combined stacking process.

Figure 8-28: Coordinate system used for [Gathering](#)

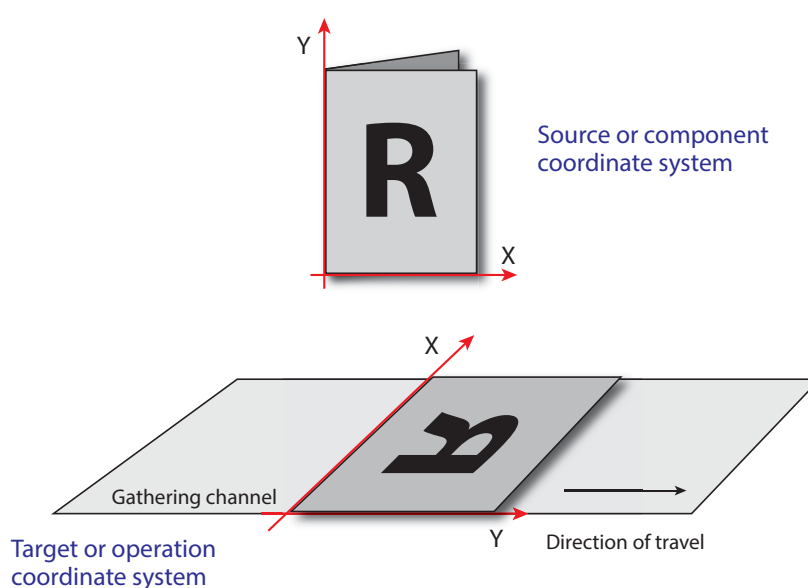

8.64 GlueApplication

New in JDF 1.1

[GlueApplication](#) specifies glue application in hard and softcover book production.

Resource Properties

Resource Class: Parameter

Resource referenced by: [CasingInParams](#), [CoverApplicationParams](#), [GluingParams/Glue](#), [SpineTapingParams](#)

Intent Pairing: [BindingIntent](#)

Table 8.101: [GlueApplication](#) Resource

NAME	DATA TYPE	DESCRIPTION
GluingTechnique	enumeration	Type or technique of gluing application. Allowed values are: SpineGluing SideGluingFront SideGluingBack
GlueLine	element	Structure of the glue line.

Figure 8-29: Parameters and coordinate system for GlueApplication

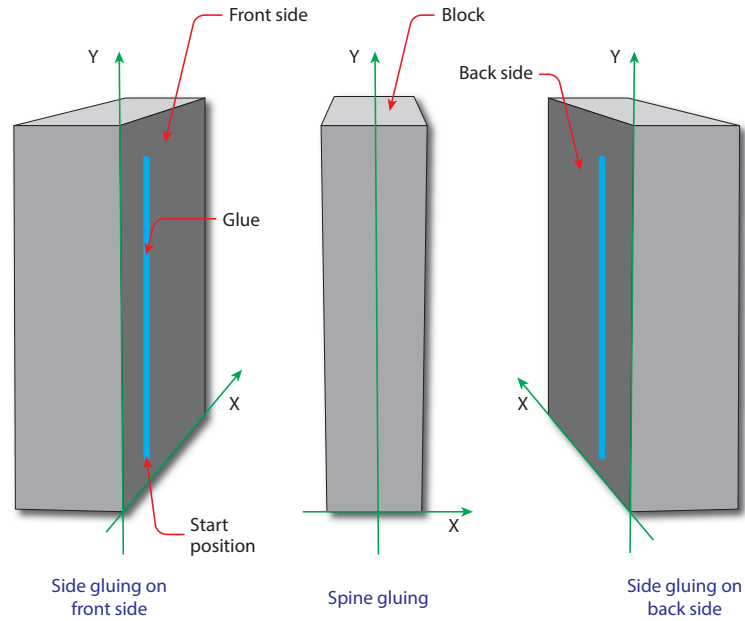

8.65 GluingParams

New in JDF 1.1

GluingParams define the parameters for applying a generic line of glue to a component.

Resource Properties

Resource Class: **Parameter**
 Intent Pairing: **BindingIntent**
 Example Partition: **"WebName", "WebProduct"**
 Input of Processes: **Gluing**

Table 8.102: GluingParams Resource

NAME	DATA TYPE	DESCRIPTION
<i>GluingProductionID</i> ? New in JDF 1.3	string	Defines a gluing scheme for production.
<i>GlueLine</i> *	element	Definition of one or more <i>GlueLine</i> line applications.

8.65.1 Glue

The **Glue** element describes how to apply a line of glue.

Table 8.103: Glue Element

NAME	DATA TYPE	DESCRIPTION
<i>WorkingDirection</i> ? Modified in JDF 1.5	enumeration	Direction from which the tool is working. Allowed value is from: ▶ WorkingDirection. Modification Note: Starting in JDF 1.5 , @WorkingDirection is optional.
<i>GlueApplication</i> ? Modified in JDF 1.3	refelement	Describes the glue application. Exactly one of <i>GlueApplication</i> or <i>GlueLine</i> SHALL be specified.
<i>GlueLine</i> ? New in JDF 1.3	element	Structure of the glue line used for generic gluing. Exactly one of <i>GlueApplication</i> or <i>GlueLine</i> SHALL be specified.

8.66 HeadBandApplicationParams

New in JDF 1.1

HeadBandApplicationParams specifies how to apply head bands in hardcover book production.

Resource Properties

Resource Class: Parameter

Input of Processes: **HeadBandApplication**

Table 8.104: HeadBandApplicationParams Resource

NAME	DATA TYPE	DESCRIPTION
<i>BottomBrand</i> ?	string	Bottom head band brand. If not specified, defaults to the value of <i>@TopBrand</i> .
<i>BottomColor</i> ?	enumeration	Color of the bottom head band. If not specified, defaults to the value of <i>@TopColor</i> . Allowed value is from: ▶ NamedColor.
<i>BottomColorDetails</i> ? New in JDF 1.4	string	A more specific, specialized or site-defined name for the color. If <i>@BottomColorDetails</i> is supplied, <i>@BottomColor</i> SHOULD also be supplied.
<i>BottomLength</i> ?	double	Length of the carrier material of the bottom head band along binding edge. If not specified, both head bands are on one carrier.
<i>StripMaterial</i> ?	enumeration	Strip material. Allowed value is from: ▶ StripMaterial.
<i>TopBrand</i> ?	string	Top head band brand.
<i>TopColor</i> ?	enumeration	Color of the top head band. Allowed value is from: ▶ NamedColor.
<i>TopColorDetails</i> ? New in JDF 1.4	string	A more specific, specialized or site-defined name for the color. If <i>@TopColorDetails</i> is supplied, <i>@TopColor</i> SHOULD also be supplied.
<i>TopLength</i> ?	double	Length of carrier material of the top head band along binding edge. If not specified, both head bands are on one carrier which has the length of the book block.
<i>Width</i> ?	double	Width of the head bands and carrier.
<i>GlueLine</i> *	element	The carrier can be applied to the book block with glue. The coordinate system for the <i>GlueLine</i> is defined in ▶ Section 8.54 EndSheetGluingParams.

8.67 HoleList

HoleList is used to describe holes or rows of holes in **Intent Resources** or **Media**. Note that it was an intent resource sub-element prior to JDF 1.2.

Resource Properties

Resource Class: Parameter

Resource referenced by: **BindingIntent/CoilBinding, BindingIntent/PlasticCombBinding, BindingIntent/StripBinding, BindingIntent/WireCombBinding, BindingIntent/BindList/BindItem/CoilBinding, BindingIntent//BindItem/PlasticCombBinding, BindingIntent/BindList/BindItem/StripBinding, BindingIntent/BindList/BindItem/WireCombBinding, HoleMakingIntent, Media**

Table 8.105: HoleList Resource

NAME	DATA TYPE	DESCRIPTION
<i>Hole</i> * Modified in JDF 1.1	element	Description of individual holes. See ▶ Section 9.26 Hole.
<i>HoleLine</i> * New in JDF 1.1	element	Array of all <i>HoleLine</i> elements. See ▶ Section 9.27 HoleLine.

8.68 HoleMakingParams

HoleMakingParams specifies the shape and positions of holes in a **Component**.

Default behavior for @HoleCount: For dealing with the default case of **@HoleCount** (i.e., when it is not supplied), intelligent systems will take into consideration job parameters like the length of the binding edge or distance of holes to the paper edges to calculate the appropriate number of holes. For production of the holes and selection/production of the matching binding element, the “system specified” values need to match 100% between the **HoleMaking** and the binding process for obvious reasons. In practice, if no details are specified for **HoleMaking**, they SHOULD also be absent for binding. In this case, either the operator provides the missing value when setting up the binding device for the job, or the device itself needs to have some kind of automatic hole detection mechanism.

Resource Properties

Resource Class:	Parameter
Resource referenced by:	CoilBindingParams , PlasticCombBindingParams , RingBindingParams , StripBindingParams , WireCombBindingParams
Intent Pairing:	HoleMakingIntent
Example Partition:	"SheetName", "SignatureName"
Input of Processes:	HoleMaking

Table 8.106: HoleMakingParams Resource (Sheet 1 of 2)

NAME	DATA TYPE	DESCRIPTION
Center ? Modified in JDF 1.1	XYPair	Position of the center of the hole pattern relative to the Component coordinate system if @HoleType is not "Explicit". If not specified, it defaults to the value implied by @HoleType .
CenterReference = "TrailingEdge" New in JDF 1.1	enumeration	Defines the reference coordinate system for @Center . Allowed values are: TrailingEdge – Physical coordinate system of the component. RegistrationMark – The center is relative to a registration mark.
Extent ?	XYPair	Size (Bounding Box) of the hole in points if @HoleType is not "Explicit". If @Shape is "Round", only the first entry of @Extent is evaluated and defines the hole diameter. If not specified, it defaults to the value implied by @HoleType .
HoleCount ? New in JDF 1.2	IntegerList	For patterns with @HoleType whose enumeration values begin with a "P", "W" or "C", this parameter specifies the number of consecutive holes and spaces. The first entry defines the number of holes, the second entry defines the number of spaces, and consecutive entries alternately define holes (h) and spaces (s), for instance: "2 2 2" = "h h s s h h". "0 3 3 3 3" = "s s s h h h s s s h h h". Note: @HoleCount is typically applied to patterns with @HoleType whose enumeration values begin with a "P", "W" or "C" in ▶ Table K.1 Naming Scheme for Hole Patterns. Default behavior: see “Default behavior for @HoleCount ”
HoleReferenceEdge ? New in JDF 1.1 Deprecated in JDF 1.2	enumeration	The edge of the media relative to where the holes are to be punched. Use with @HoleType . Default value: if @HoleType is "Explicit", "Pattern"; otherwise "Left". Allowed values are: Left Right Top Bottom Pattern – Specifies that the reference edge implied by the value of @HoleType in ▶ Appendix K Hole Pattern Catalog is used. Deprecation note: Starting with JDF 1.1, use an explicit @Transformation or @Orientation of the input Component . If either @Transformation or @Orientation along with @HoleReferenceEdge is specified, the result is the matrix product of both transformations. @Transformation or @Orientation SHALL be applied first.

Table 8.106: HoleMakingParams Resource (Sheet 2 of 2)

NAME	DATA TYPE	DESCRIPTION
HoleType New in JDF 1.1	enumerations	Predefined hole pattern. Multiple hole patterns are specified as one NMTO-KENS string (e.g., 3-hole ring binding and 4-hole ring binding holes on one piece of media). Allowed values are: Explicit – Holes are defined in an array of hole elements. 2HoleEuro – Replaced by either <i>R2m-DIN</i> or <i>R2m-ISO</i> . Deprecated in JDF 1.0 3HoleUS – Replaced by <i>R3I-US</i> . Deprecated in JDF 1.0 4HoleEuro – Replaced by either <i>R4m-DIN-A4</i> or <i>R4m-DIN-A5</i> . Deprecated in JDF 1.0 Allowed values are from: ▶ Appendix K Hole Pattern Catalog.
Shape ? Modified in JDF 1.1	enumeration	Shape of the holes if @HoleType is not "Explicit". Default value is: value implied by @HoleType . Allowed values are: Elliptic Round Rectangular
Hole *	element	Description of individual Hole elements.
HoleLine * New in JDF 1.1	element	Description of HoleLine elements.
RegisterMark ? New in JDF 1.1	refelement	Reference to the registration mark that defines the coordinate system origin for HoleMaking .

8.69 IdentificationField

[IdentificationField](#) contains information about a mark on a document (e.g., a bar code) used for OCR-based verification purposes or document separation.

Resource Properties

Resource Class: Parameter

Resource referenced by: [AbstractPhysicalResource](#), [Disjointing](#), [EmbossingParams/Emboss](#), [Layout/MarkObject](#), [LayoutElementProductionParams/LayoutElementPart/BarcodeProductionParams](#)

Table 8.107: IdentificationField Resource (Sheet 1 of 2)

NAME	DATA TYPE	DESCRIPTION
<p><i>BoundingBox</i> ?</p>	<p>rectangle</p>	<p>Box that provides the boundaries of the mark that indicates where the IdentificationField is placed. If the IdentificationField is specified in a Layout, the coordinate system is defined by the MarkObject containing the IdentificationField. If no Layout context is available, the origin of the coordinate system is defined as the lower left corner of the resource surface that @Position specifies when the specified surface is viewed in its natural orientation.</p> <p>Each item in the list below specifies a value of @Position and the corner that is the origin for the specified value when the viewer is positioned in front of the front surface. For example, when @Position="Left", the origin is the bottom-back corner of left surface when viewed from the front surface of the resource and lower left corner when viewed from the left surface.</p> <p>"Front" – Bottom left corner "Left" – Bottom back corner "Back" – Bottom right corner "Right" – Bottom front corner "Top" – Front-left corner "Bottom" – Back left corner</p> <p>If no @BoundingBox is defined and the IdentificationField is specified</p> <ul style="list-style-type: none"> outside the context of a Layout Then the complete visible surface SHALL be scanned for an appropriate bar code. within the context of a Layout Then the implied @BoundingBox is specified by MarkObject/@ClipBox. <p>The @BoundingBox is used only as metadata when searching or scanning IdentificationField elements and not used when generating IdentificationField elements in a LayoutElementProduction process.</p> <p>Modification note: Starting with JDF 1.4, all text is new.</p>
<p><i>Encoding</i> ? Modified in JDF 1.4</p>	<p>enumeration</p>	<p>Encoding of the information.</p> <p>Allowed values are:</p> <p>ASCII – Plain-text font. Barcode – Any bar code. New in JDF 1.3 BarCode1D – One-dimensional bar code. Deprecated in JDF 1.3 BarCode2D – Two-dimensional bar code. Deprecated in JDF 1.3 Braille – Braille text. New in JDF 1.4 RFID – Radio Frequency Identification tag. New in JDF 1.3</p>
<p><i>EncodingDetails</i> ?</p>	<p>NMTOKEN</p>	<p>Details about the encoding type. An example is the bar code scheme.</p> <p>Values include those from: ▶ Table 8.108 EncodingDetails Attribute Values.</p>
<p><i>Format</i> ? Modified in JDF 1.2</p>	<p>regExp</p>	<p>Regular expression that defines the expected format of the expression (e.g., the number of digits, alphanumeric or numeric). Note that this field MAY also be used to define constant fields (e.g., the end of document markers or packaging labels). If not specified, any expression is valid. Exactly one of @Format, @Value or the pair @ValueFormat and @ValueTemplate SHALL be specified.</p>
<p><i>Orientation</i> ?</p>	<p>matrix</p>	<p>Orientation of the contents within the IdentificationField. The coordinate system is defined in the system of the sheet or component where the IdentificationField resides. @Orientation is used only as metadata when searching or scanning IdentificationField elements and not used when generating IdentificationField elements in a LayoutElementProduction process.</p>
<p><i>Page</i> ?</p>	<p>integer</p>	<p>If @Position="Page", this refers to the page where the IdentificationField can be found. Negative values denote an offset relative to the last page in a stack of pages.</p>

Table 8.107: IdentificationField Resource (Sheet 2 of 2)

NAME	DATA TYPE	DESCRIPTION
<i>Position</i> ?	enumeration	Position with respect to the instance document or <i>PhysicalResource</i> to which the resource refers. Allowed values are: <i>Header</i> – Sheet before the document. <i>Trailer</i> – Sheet after the document. <i>Page</i> – A page of the document. <i>Top</i> – The top of the resource. <i>Bottom</i> – The bottom of the resource. <i>Left</i> – The left side of the resource. <i>Right</i> – The right side of the resource. <i>Front</i> – The front side of the resource. <i>Back</i> – The back side of the resource. <i>Any</i> – Deprecated in JDF 1.2
<i>Purpose</i> ?	enumeration	Purpose defines the usage of the field. Allowed values are: <i>Label</i> – Used to mark a product or component. <i>Separation</i> – Used to separate documents. <i>Verification</i> – Used for verification of documents.
<i>PurposeDetails</i> ? New in JDF 1.3	NMTOKEN	More detail about the usage of the barcode. Values include: <i>ProductIdentification</i> – End product identification (e.g., scanning in the super market).
<i>Value</i> ? New in JDF 1.1	string	Fixed value of the <i>IdentificationField</i> (e.g., on a label). Exactly one of <i>@Format</i> , <i>@Value</i> or the pair <i>@ValueFormat</i> and <i>@ValueTemplate</i> SHALL be specified.
<i>ValueFormat</i> ? New in JDF 1.3	string	A formatting string used with <i>@ValueTemplate</i> to define fixed and/or variable content of barcodes or text. Allowed values are from: ▶ Appendix H String Generation. Constraint: Exactly one of <i>@Format</i> , <i>@Value</i> or the pair <i>@ValueFormat</i> and <i>@ValueTemplate</i> SHALL be specified.
<i>ValueTemplate</i> ? New in JDF 1.3	string	A list of values used with <i>@ValueFormat</i> to define fixed and/or variable content of barcodes or text. If <i>MetadataMap</i> elements are present, <i>MetadataMap/@Name</i> SHALL be included in <i>@ValueTemplate</i> to select the data from the <i>MetadataMap</i> . Allowed values are from: ▶ Appendix H String Generation. Constraint: Exactly one of <i>@Format</i> , <i>@Value</i> or the pair <i>@ValueFormat</i> and <i>@ValueTemplate</i> SHALL be specified.
<i>BarcodeDetails</i> ? New in JDF 1.3	element	Additional specification for complex barcodes.
<i>ExtraValues</i> ? New in JDF 1.3	element	Additional values encoded in the <i>IdentificationField</i> .
<i>MetadataMap</i> * New in JDF 1.5	element	Describes the mapping of metadata that is encoded in an <i>IdentificationField</i> to <i>@PartIDKeys</i> . This allows for automated selective finishing based on bar codes.

The following list provides a sample of barcode encoding details. Values that are not present in this list MAY be valid in a **JDF** workflow.

Table 8.108: EncodingDetails Attribute Values (Sheet 1 of 2)

VALUE	DESCRIPTION	VALUE	DESCRIPTION
BOBST		ITF_14	

Table 8.108: EncodingDetails Attribute Values (Sheet 2 of 2)

VALUE	DESCRIPTION	VALUE	DESCRIPTION
BrailleASCII New in JDF 1.4	A binary representation for 6 dot Braille messages. See ▶ [Braille ASCII].	ITF_6	
BrailleUnicode New in JDF 1.4	A binary representation for Braille messages. See ▶ [Braille Unicode].	ITF_16	
CODABAR		KURANDT	
CODABAR_Tradional		LAETUS_PHARMA	
CODABLOCK		MSI	
CODABLOCK_F		NDC_HRI	
Code128		PARAF	
Code25		Plessey	
Code39		PDF417	
Code39_Extended		PZN	
DATAMATRIX Deprecated in JDF 1.3	Deprecation note: Starting with JDF 1.3, use "HIBC_ - DATAMATRIX"	QR	
EAN	includes Bookland_EAN and ISSN.	RSS_14	
EAN_13		RSS_14_Stacked	
EAN_8		RSS_14_Stacked_Omnidir	
EAN_Coupon		RSS_14_Truncated	
EAN_128		RSS_Limited	
HIBC_Code39		RSS_Expanded	
HIBC_Code128		RSS_Expanded_Stacked	
HIBC_Code39_2		UPC_A	
HIBC_CODABLOCK_F		UPC_Coupon	
HIBC_QR		UPC_E	
HIBC_DATAMATRIX		UPC_SCS	
Interleave25			

8.69.1 BarcodeDetails

Table 8.109: BarcodeDetails Element (Sheet 1 of 2)

NAME	DATA TYPE	DESCRIPTION
<i>BarcodeVersion</i> ?	NMTOKEN	The version of a barcode. Values include those from: ▶ Table 8.112 BarcodeVersion Values – for an HIBC_DATAMATRIX. Values include those from: ▶ Table 8.113 BarcodeVersion Values – for QR barcodes.

Table 8.109: BarcodeDetails Element (Sheet 2 of 2)

NAME	DATA TYPE	DESCRIPTION
ErrorCorrectionLevel ?	NMTOKEN	<p>Error correction level for barcodes having a separately definable error correction level.</p> <p>Each value can be used only for certain values of IdentificationField/@EncodingDetails.</p> <p>Values include:</p> <p>PDF417_EC_0 – for @EncodingDetails="PDF417"</p> <p>PDF417_EC_1 – for @EncodingDetails="PDF417"</p> <p>PDF417_EC_2 – for @EncodingDetails="PDF417"</p> <p>PDF417_EC_3 – for @EncodingDetails="PDF417"</p> <p>PDF417_EC_4 – for @EncodingDetails="PDF417"</p> <p>PDF417_EC_5 – for @EncodingDetails="PDF417"</p> <p>PDF417_EC_6 – for @EncodingDetails="PDF417"</p> <p>PDF417_EC_7 – for @EncodingDetails="PDF417"</p> <p>PDF417_EC_8 – for @EncodingDetails="PDF417"</p> <p>QR_EC_L – for @EncodingDetails="QR"</p> <p>QR_EC_M – for @EncodingDetails="QR"</p> <p>QR_EC_Q – for @EncodingDetails="QR"</p> <p>QR_EC_H – for @EncodingDetails="QR"</p>
XCells ?	integer	<p>The number of cells in x direction of a matrix barcode. For "DATAMATRIX" this field can be omitted since @BarcodeVersion already defines this.</p> <p>For "PDF417" this is the number of codewords/row.</p>
YCells ?	integer	<p>The number of cells in y direction of a matrix barcode. For "DATAMATRIX" this field can be omitted since @BarcodeVersion already defines this.</p> <p>For "PDF417" this is the number of rows.</p>

8.69.2 ExtraValues

Table 8.110: ExtraValues Element

NAME	DATA TYPE	DESCRIPTION
Usage	NMTOKEN	<p>The usage of the value.</p> <p>Values include:</p> <p>Supplemental – UPC supplemental 2/5 digit symbology</p> <p>CompositeCode – This is applicable for barcodes like RSS-14 that have an optional composite code part.</p> <p>Coupon – The additional message for the EAN128 part of a UPC or EAN coupon.</p>
Value	string	Additional value of the IdentificationField as specified in @Usage .

8.69.3 Usage of barcode attributes

The following table specifies whether the attributes [@Height](#), [@Magnification](#) and [@Ratio](#) are applicable for a given barcode type that is specified by [@EncodingDetails](#).

Table 8.111: Usage of Barcode Attributes for Certain Barcode Types (Sheet 1 of 2)

ENCODINGDETAILS VALUES (BARCODE TYPES)	HEIGHT	MAGNIFICATION	RATIO
Code25	Used	Used	Used
Code39			
Code39_Extended			
Interleave25			
MSI			
Plessey			

Table 8.111: Usage of Barcode Attributes for Certain Barcode Types (Sheet 2 of 2)

ENCODINGDETAILS VALUES (BARCODE TYPES)	HEIGHT	MAGNIFICATION	RATIO
CODABAR Code128 EAN_13 EAN_8 EAN_128 HIBC_Code39 HIBC_Code128 ITF_14 ITF_16 NDC_HRI PARAF UPC_A UPC_E UPC_SCS	Used	Used	Not used
BOBST KURANDT LAETUS_PHARMA	Used	Not used	Not used
RSS_14 RSS_14_Stacked RSS_14_Stacked_Omnidir RSS_14_Truncated RSS_Limited RSS_Expanded RSS_Expanded_Stacked	Not used	Used	Not used
PZN	Not used	Not used	Not used

The following table specifies valid values of [BarcodeDetails/@BarcodeVersion](#) for a "HIBC_DATAMATRIX" barcode:
Modification note: Starting with JDF 1.3, these values are for "HIBC_DATAMATRIX" rather than "DATAMATRIX"

Table 8.112: BarcodeVersion Values – for an HIBC_DATAMATRIX

VALUES			
DM_8_by_18	DM_16_by_16	DM_26_by_26	DM_72_by_72
DM_8_by_32	DM_16_by_36	DM_32_by_32	DM_80_by_80
DM_10_by_10	DM_16_by_48	DM_40_by_40	DM_88_by_88
DM_12_by_12	DM_18_by_18	DM_44_by_44	DM_96_by_96
DM_12_by_26	DM_20_by_20	DM_48_by_48	DM_104_by_104
DM_12_by_36	DM_22_by_22	DM_52_by_52	DM_120_by_120
DM_14_by_14	DM_24_by_24	DM_64_by_64	DM_132_by_132
			DM_144_by_144

The following table specifies valid values of [BarcodeDetails/@BarcodeVersion](#) for a QR barcode.

Table 8.113: BarcodeVersion Values – for QR barcodes (Sheet 1 of 2) (Sheet 1 of 2) (Sheet 1 of 2)

VALUES							
QR_1	QR_6	QR_11	QR_16	QR_21	QR_26	QR_31	QR_36

Table 8.113: BarcodeVersion Values – for QR barcodes (Sheet 2 of 2) (Sheet 2 of 2) (Sheet 2 of 2)

VALUES							
QR_2	QR_7	QR_12	QR_17	QR_22	QR_27	QR_32	QR_37
QR_3	QR_8	QR_13	QR_18	QR_23	QR_28	QR_33	QR_38
QR_4	QR_9	QR_14	QR_19	QR_24	QR_29	QR_34	QR_39
QR_5	QR_10	QR_15	QR_20	QR_25	QR_30	QR_35	QR_40

Example 8.18: Barcode

The following example illustrates the description of a barcode in a **LayoutElementProduction** process:

```
<LayoutElementProductionParams Class="Parameter" ID="BarcodeParams" Status="Available">
  <LayoutElementPart>
    <BarcodeProductionParams>
      <IdentificationField Encoding="Barcode"
        EncodingDetails="EAN_13" Purpose="Label"
        PurposeDetails="ProductIdentification" Value="0123456789128"/>
      <BarcodeReproParams Height="73.50" Magnification="1.0">
        <BarcodeCompParams CompensationProcess="Printing" CompensationValue="10.0"/>
      </BarcodeReproParams>
    </BarcodeProductionParams>
  </LayoutElementPart>
</LayoutElementProductionParams>
```

8.70 IDPrintingParams

Deprecated in JDF 1.1

8.71 ImageCompressionParams

Prior to **JDF 1.2** the filtering in **ImageCompressionParams** was based on the terminology in PostScript and PDF. Many image compression and decompression filters require additional information in the form of a filter parameter dictionary, and additional filter parameters have been added to meet this need.

Resource Properties

Resource Class: Parameter

Resource referenced by: [ContentList/ContentData](#), [FormatConversionParams](#), [LayoutElement](#), [PageList](#), [PageList/PageData](#)

Example Partition: "DocIndex", "RunIndex", "RunTags", "DocTags", "PageTags", "SetTags", "SheetName", "Side", "SignatureName"

Input of Processes: [ImageReplacement](#), [PDLCreation](#), [PSToPDFConversion](#)

Table 8.114: ImageCompressionParams Resource

NAME	DATA TYPE	DESCRIPTION
ImageCompression *	element	Specifies how images are to be compressed.

8.71.1 ImageCompression

Table 8.115: ImageCompression Element (Sheet 1 of 3)

NAME	DATA TYPE	DESCRIPTION
AntiAliasImages="false"	boolean	If "true", anti-aliasing is permitted on images. If "false", anti-aliasing is not permitted. Anti-aliasing increases the number of bits per component in downsampled images to preserve some of the information that is otherwise lost by downsampling. Anti-aliasing is only performed if the image is actually downsampled and if @ImageDepth has a value greater than the number of bits per color component in the input image.

Table 8.115: ImageCompression Element (Sheet 2 of 3)

NAME	DATA TYPE	DESCRIPTION
<i>AutoFilterImages</i> = "true" Modified in JDF 1.2	boolean	SHALL NOT be specified unless <i>@EncodeImages</i> is "true". This attribute is not used if <i>@ImageType</i> ="Monochrome". If "true", the filter defined by <i>@ImageAutoFilterStrategy</i> is applied to photos and the "FlateEncode" filter is applied to screen shots. If "false", the <i>@ImageFilter</i> compression method is applied to all images.
<i>ConvertImagesToIndexed</i> ?	boolean	If "true", the application converts images that use fewer than 257 colors to an indexed color space for compactness. This attribute is used only when <i>@ImageType</i> ="Color".
<i>DCTQuality</i> ="0"	double	A value between 0.0 and 1.0 that indicates "how much" the process SHALL compress images when using a "DCTEncode" filter. 0.0 means "do as loss-less compression as possible." 1.0 means "do the maximum compression possible."
<i>DownsampleImages</i> ="false" Modified in JDF 1.1A	boolean	If "true", sampled color images are downsampled using the resolution specified by <i>@ImageResolution</i> . If "false", downsampling is not carried out and the image resolution in the PDF file is the same as that in the source file.
<i>EncodeColorImages</i> ? Deprecated in JDF 1.1	boolean	If "true", color images are encoded using the compression filter specified by the value of the <i>@ImageFilter</i> key. If "false", no compression filters are applied to color sampled images.
<i>EncodeImages</i> ="false" New in JDF 1.1 Modified in JDF 1.1A	boolean	If "true", images are encoded using the compression filter specified by the value of the <i>@ImageFilter</i> key. If "false", no compression filters are applied to sampled images.
<i>ImageAutoFilterStrategy</i> ? New in JDF 1.2	NMTOKEN	Selects what image compression strategy to employ if passing through an image that is not already compressed. Values include: JPEG – Lossy JPEG compression for low-frequency images and lossless Flate compression for high-frequency images. JPEG2000 – Lossy JPEG2000 compression for low-frequency images and lossless JPEG2000 compression for high-frequency images.
<i>ImageDepth</i> ?	integer	Specifies the number of bits per component in the downsampled image when <i>@DownsampleImages</i> ="true". If not specified, the downsampled image has the same number of bits per sample as the original image.
<i>ImageDownsampleThreshold</i> ="2.0"	double	Sets the image downsample threshold for images. This is the ratio of image resolution to output resolution above which downsampling can be performed. For example, if <i>@ImageDownsampleThreshold</i> ="1.5" and <i>@ImageResolution</i> ="72" then the input image would not be downsampled unless it has a resolution greater than $(72 * 1.5) = 108$ dpi
<i>ImageDownsampleType</i> ?	enumeration	Downsampling algorithm for images. Allowed values are: Average – The program averages groups of samples to get the new downsampled value. Bicubic – The program uses bicubic interpolation on a group of samples to get a new downsampled value. Subsample – The program picks the middle sample from a group of samples to get the new downsampled value.

Table 8.115: ImageCompression Element (Sheet 3 of 3)

NAME	DATA TYPE	DESCRIPTION
<i>ImageFilter</i> ? Modified in JDF 1.3	NMTOKEN	Specifies the compression filter to be used for images. Ignored if <i>@AutoFilterImages="true"</i> or if <i>@EncodeImages="false"</i> . Values include: <i>CCITTFaxEncode</i> – Used to select CCITT Group 3 or 4 facsimile encoding. Used only if <i>@ImageType="Monochrome"</i> . <i>DCTEncode</i> – Used to select JPEG compression. <i>FlateEncode</i> – Used to select zip compression. <i>JBIG2Encode</i> – Used to select JBIG2 encoding. Used only if <i>@ImageType="Monochrome"</i> . New in JDF 1.3 <i>JPEG2000</i> – Used to select JPEG2000/Wavelet compression. New in JDF 1.2 <i>LZWEncode</i> – LZW compression. <i>PackBits</i> – A simple byte-oriented run length scheme. Modification note: Starting with JDF 1.1 , the data type changes from enumeration to NMTOKEN in order to allow for extensions.
<i>ImageResolution</i> ?	double	Specifies the minimum resolution for downsampled color images in dots per inch. This value is used only when <i>@DownsampleImages="true"</i> . The application downsamples only images that are above that resolution to that actual resolution.
<i>ImageType</i> Modified in JDF 1.5	enumerations	Specifies the kind of images that are to be manipulated. Allowed values are: <i>All</i> – Image compression is applied to all image types. New in JDF 1.5 <i>Color</i> <i>Grayscale</i> <i>Monochrome</i>
<i>JPXQuality</i> ? New in JDF 1.2	integer	Specifies the image quality. Valid values are greater than or equal to one (1) and less than or equal to 100. One (1) means lowest quality (highest compression), 99 means visually lossless compression, and 100 means numerically lossless compression.
<i>CCITTFaxParams</i> ? New in JDF 1.2	element	The equivalent of the PostScript <i>Rows</i> and <i>BlackIs1</i> parameters, which are implicit in the raster data to be compressed.
<i>DCTParams</i> ? New in JDF 1.2	element	Provides the equivalents of the PostScript <i>Columns</i> , <i>Rows</i> and <i>Colors</i> attributes, which are assumed to be implicit in the raster data to be compressed.
<i>FlateParams</i> ? New in JDF 1.2	element	The equivalent of the PostScript <i>Columns</i> , <i>BitsPerComponent</i> and <i>Colors</i> parameters, which are implicit in the raster data to be compressed.
<i>JBIG2Params</i> ? New in JDF 1.3	element	Provides the JBIG2 compression parameters.
<i>JPEG2000Params</i> ? New in JDF 1.3	element	Provides the JPEG2000 compression parameters.
<i>LZWParams</i> ? New in JDF 1.2	element	The equivalent of the PostScript <i>Columns</i> , <i>BitsPerComponent</i> and <i>Colors</i> parameters, which are implicit in the raster data to be compressed

8.71.2 CCITTFaxParams

New in JDF 1.2

Table 8.116: CCITTFaxParams Element (Sheet 1 of 2)

NAME	DATA TYPE	DESCRIPTION
<i>EncodedByteAlign</i> ?	boolean	A flag indicating whether the CCITTFaxEncode filter inserts an extra 0 bits before each encoded line so that the line begins on a byte boundary.
<i>EndOfBlock</i> ?	boolean	A flag indicating whether the CCITTFaxEncode filter appends an end-of-block pattern to the encoded data

Table 8.116: CCITTFaxParams Element (Sheet 2 of 2)

NAME	DATA TYPE	DESCRIPTION
<i>EndOfLine</i> ?	boolean	A flag indicating whether the CCITTFaxEncode filter prefixes an end-of-line bit pattern to each line of encoded data.
<i>K = "0"</i>	integer	An integer that selects the encoding scheme to be used. < 0 – Pure two-dimensional encoding (Group 4, TIFF compression = 4) = 0 – Pure one-dimensional encoding (Group 3, 1-D, TIFF compression = 2) > 0 – Mixed one- and two-dimensional encoding (Group 3, 2-D, TIFF compression = 3), in which a line encoded one-dimensionally can be followed by at most K – 1 lines encoded two-dimensionally
<i>Uncompressed = "false"</i>	boolean	A flag to indicate whether the file generated can use uncompressed encoding when advantageous.

8.71.3 DCTParams

New in JDF 1.2

Table 8.117: DCTParams Element

NAME	DATA TYPE	DESCRIPTION
<i>ColorTransform = "Automatic"</i>	enumeration	Color transformation algorithm. Allowed values are: <i>None</i> – Colors are not to be transformed. <i>YUV</i> – RGB raster values are to be transformed to YUV before encoding and from YUV to RGB after decoding. If four channels are present, transform CMYK values to YUVK before encoding and from YUVK to CMYK after decoding. <i>Automatic</i> – "YUV" for 3-channel raster data, "None" otherwise. Note: YUV is equivalent to YCbCr in TIFF terminology.
<i>HSamples</i> ?	IntegerList	A sequence of horizontal sampling factors—one entry per color channel in the raster data. If not specified, the implied default is "1" for every channel.
<i>HuffTable</i> ?	DoubleList	Huffman tables for DC and AC components. If present, there SHALL be at least one HuffTable element for each color channel.
<i>QFactor="1.0"</i>	double	A scale factor applied to the elements of @QuantTable.
<i>QuantTable</i> ?	DoubleList	Quantization tables. If present, there SHALL be one @QuantTable entry for each color channel.
<i>SourceCSs</i> ? Deprecated in JDF 1.6	enumerations	Identifies which of the incoming color spaces will be operated on. If @SourceCSs is not specified then ColorSpaceConversionOp SHALL apply to all color spaces. Allowed values are from: ▶ SourceColorSpace. Note: JDF 1.1 defined that CalRGB be treated as RGB, CalGray as Gray, and ICC-Based color spaces as one of Gray, RGB or CMYK depending on the number of channels. Note: In JDF 1.2, the data type was erroneously specified as enumeration, not enumerations.
<i>VSamples</i> ?	IntegerList	A sequence of vertical sampling factors—one entry per color channel in the raster data. If not specified, the implied default is "1" for every channel.

When the *DCTParams* element is a subelement of *ImageCompressionParams* used in a *Rendering* process to generate TIFF files, YUV is equivalent to YCbCr in TIFF terminology. The *HSamples* and *VSamples* values are used to set YCbCrSubSampling or CIELabSubSampling. This means that they are only relevant for data supplied as Lab, or data where @ColorTransform is "YUV"; that the first element SHALL be 1 in each case; that the fourth element SHALL be 1 where CMYK data is to be compressed; and that the second and third elements SHALL equal each other.

8.71.4 FlateParams

New in JDF 1.2

Table 8.118: FlateParams Element

NAME	DATA TYPE	DESCRIPTION
<i>Effort</i> ?	integer	A code controlling the amount of memory used and the execution speed for Flate compression. Allowed values range from 0 to 9. A value of 0 compresses rapidly but not tightly, using little auxiliary memory. A value of 9 compresses slowly but as tightly as possible, using a large amount of auxiliary memory.
<i>Predictor</i> = "1"	integer	A code that selects the predictor function: Note: On 1X PNG predictors, these values select the specific PNG predictor function(s) to be used, as indicated above. When decoding the predictor function is explicitly encoded in the incoming data. Values include: 1 – No predictor (normal encoding or decoding). 2 – TIFF Predictor 2. 10 – PNG predictor, None function. 11 – PNG predictor, Sub function. 12 – PNG predictor, Up function. 13 – PNG predictor, Average function. 14 – PNG predictor, Path function. 15 – PNG predictor in which the encoding filter automatically chooses the optimum function separately for each row.

8.71.5 JBIG2Params

New in JDF 1.3

Table 8.119: JBIG2Params Element

NAME	DATA TYPE	DESCRIPTION
<i>JBIG2Lossless</i> ?	boolean	If "true" requires JBIG2 compressed images to retain the exact representation of the original image without loss.

8.71.6 JPEG2000Params

New in JDF 1.3

Table 8.120: JPEG2000Params Element (Sheet 1 of 2)

NAME	DATA TYPE	DESCRIPTION
<i>CodeBlockSize</i> ?	integer	The nominal code block width and height. SHALL be a power of 2.
<i>LayerRates</i> ?	DoubleList	Compression bit ratio for each layer. If specified, there SHALL be the same number of doubles in this list as @LayersPerTile in ascending order. Small values correspond to maximum compression and 1.0 corresponds to no compression (lossless). If available, @LayerRates SHOULD be supplied.
<i>LayersPerTile</i> = "1"	integer	Specifies the number of quality layers per tile at the same resolution.
<i>NumResolutions</i> ?	integer	The number of resolution levels encoded in the file.
<i>ProgressionOrder</i> ?	enumeration	Per tile progression order. Allowed values are: LRCP – layer-resolution-component-position progressive (i.e., rate scalable). RLCP – Resolution-layer-component-position progressive (i.e., resolution scalable). RPCL – Resolution-position-component-layer progressive. PCRL – Position-component-resolution-layer progressive. CPRL – Component-position-resolution-layer progressive.

Table 8.120: JPEG2000Params Element (Sheet 2 of 2)

NAME	DATA TYPE	DESCRIPTION
<i>TileSize</i> ?	XYPair	The width and height of each encoding tile. If not specified the image is considered to be a single tile.

8.71.7 LZWParams

New in JDF 1.2

Table 8.121: LZWParams Element

NAME	DATA TYPE	DESCRIPTION
<i>EarlyChange</i> = "1"	integer	A code indicating when to increase the code word length. The TIFF specification can be interpreted to imply that increases in code word length are postponed as long as possible. However, some existing implementations of LZW increase the code word length one code word earlier than necessary. The PostScript language supports both interpretations. If <i>@EarlyChange</i> is "0", code word length increases are postponed as long as possible. If it is "1", they occur one code word earlier. Note: The default SHOULD NOT be used when this <i>LZWParams</i> element is in <i>ImageCompressionParams</i> used as an input resource to a <i>FormatConversion</i> process that is creating TIFF files.
<i>Predictor</i> = "1"	integer	A code that selects the predictor function: 1 – No predictor (normal encoding or decoding). 2 – TIFF Predictor 2. 10 – PNG predictor, None function. 11 – PNG predictor, Sub function. 12 – PNG predictor, Up function. 13 – PNG predictor, Average function. 14 – PNG predictor, Path function. 15 – PNG predictor in which the encoding filter automatically chooses the optimum function separately for each row. Note: On 1X PNG predictors, these values select the specific PNG predictor function(s) to be used, as indicated above. When decoding, the predictor function is explicitly encoded in the incoming data.

8.72 ImageEnhancementParams

ImageEnhancementParams describes the controls for manipulating images.

New in JDF 1.5

Resource Properties

Resource Class: Parameter

Input of Processes: *ImageEnhancement*

Table 8.122: ImageEnhancementParams Resource

NAME	DATA TYPE	DESCRIPTION
<i>ImageEnhancementOp</i> *	element	Each <i>ImageEnhancementOp</i> describes an individual enhancement operation. The XML order of <i>ImageEnhancementOp</i> elements is significant. Multiple elements that apply to the same object SHALL be applied in that XML order.

8.72.1 ImageEnhancementOp

New in JDF 1.5

Table 8.123: ImageEnhancementOp Element

NAME	DATA TYPE	DESCRIPTION
<i>ObjectTags</i> ?	NMTOKENS	Tags associated with individual objects that this <i>ImageEnhancementOp</i> SHALL be applied to. Each tag specified in <i>@ObjectTags</i> is logically anded with the object type(s) specified by <i>@SourceObjects</i> , enabling first qualification by object type (such as image), and then tags associated with those objects. The values of <i>@ObjectTags</i> depends on the PDL that the color correction is applied to. <i>@ObjectTags</i> SHALL apply only to objects whose tag pool includes all the tags in the value of <i>@ObjectTags</i> .
<i>Operation</i>	NMTOKEN	Individual enhancement operation name. Values include: <i>BestGuess</i> – Best guess automated improvements based on image analysis. <i>Blurring</i> – Image blurring. <i>RedEyeRemoval</i> – Automated removal of red eye artifacts in images. <i>Sharpening</i> – Image sharpening.
<i>OperationDetails</i> ?	string	Additional details of the <i>@Operation</i> . The values are implementation specific.
<i>SourceObjects</i> ?	enumerations	Identifies which class(es) of incoming graphical objects SHALL be operated on. If <i>@SourceObjects</i> is not specified then <i>ImageEnhancementOp</i> SHALL apply to all object classes. Allowed values are from: ▶ <i>SourceObjects</i> .

8.73 ImageReplacementParams

ImageReplacementParams specifies parameters to control image replacement within production workflows.

Resource Properties

Resource Class: Parameter

Example Partition: "DocIndex", "RunIndex", "RunTags", "DocTags", "PageTags", "SetTags", "SheetName", "Side", "SignatureName"

Input of Processes: *ImageReplacement*

Table 8.124: ImageReplacementParams Resource (Sheet 1 of 2)

NAME	DATA TYPE	DESCRIPTION
<i>IgnoreExtensions</i> ?	NMTOKENS	Identifies a set of filename extensions that will be trimmed during searches for high-resolution images. These extensions are what will be stripped from the end of an image name to find a base name. The leading dot "." is included. The values are examples: Values include: .lay .e .samp
<i>ImagePreScanStrategy</i> ? New in JDF 1.2	NMTOKEN	Specifies the image pre-scanning strategy to be used on the input document data before starting the <i>RIPing</i> . Values include: <i>NoPreScan</i> – Do not pre-scan the document looking for references to images. <i>PreScan</i> – Pre-scan the document looking for references to images and making sure the data are accessible now so that the RIP will not encounter a fault later. <i>PreScanAndGather</i> – Pre-scan the document looking for references to images, and copy the data to a temporary place so that the RIP will be able to access the data with a predictable and small well-bounded delay later.

Table 8.124: ImageReplacementParams Resource (Sheet 2 of 2)

NAME	DATA TYPE	DESCRIPTION
ImageReplacementStrategy	enumeration	Identifies how externally referenced images will be handled within the associated process. Allowed values are: Omit – Complete process maintaining only references to external data. Proxy – Complete process using available proxy images. Replace – Replace external references with image data during processing. AttemptReplacement – Attempt to replace external references with image data during processing. If replacement fails, complete the process using available proxy images.
MaxResolution ? Deprecated in JDF 1.1	double	Reduces the resolution of images with a resolution higher than @MaxResolution. Replaced with a link to ImageCompressionParams in the process.
MaxSearchRecursion ?	integer	Identifies how many levels of recursion in the search path will be traversed while trying to locate images. A value of 0 indicates that no recursion is desired.
MinResolution ?	double	Specifies the minimum resolution that an image SHALL have in order to be embedded. If not specified, images of any resolution can be embedded.
ResolutionReductionStrategy ? Deprecated in JDF 1.1	enumeration	Identifies the mechanism used for reducing the image resolution. Allowed values are: Downsample Subsample Bicubic Deprecation note: Starting with JDF 1.1, use a link to ImageCompressionParams in the process.
FileSpec (SearchPath) + New in JDF 1.1	reference	Specification of the paths to search when trying to locate the referenced data. FileSpec replaces the SearchPath text.
SearchPath * Deprecated in JDF 1.1	element	String that identifies the paths to search when trying to locate the referenced data.

8.73.1 SearchPath

Table 8.125: SearchPath Element

NAME	DATA TYPE	DESCRIPTION
	text	Text content of the SearchPath .

8.74 ImageSetterParams

[ImageSetterParams](#) specifies the settings for an imagesetter. A number of settings are OEM-specific, while others are so widely used they MAY be supported between vendors. Both filmsetter settings and platesetter settings are described with this resource.

Resource Properties

- Resource Class: Parameter
- Resource referenced by: [PreviewGenerationParams](#)
- Intent Pairing: [ProofingIntent](#)
- Input of Processes: [ImageSetting](#)

Table 8.126: ImageSetterParams Resource (Sheet 1 of 3)

NAME	DATA TYPE	DESCRIPTION
AdvanceDistance ?	double	Additional media advancement beyond the media dimensions on a web fed device.

Table 8.126: ImageSetterParams Resource (Sheet 2 of 3)

NAME	DATA TYPE	DESCRIPTION
<i>BurnOutArea</i> ? New in JDF 1.1	XYPair	Size of the burnout area. The area defined by <i>@BurnOutArea</i> is exposed, regardless of the size of the image. If not specified or "0 0", only the area defined by the image is exposed.
<i>CenterAcross</i> ?	enumeration	Specifies the axis around which a device SHALL center an image if the device is capable of doing so. Allowed value is from: ▶ Axis.
<i>CutMedia</i> ?	boolean	Indicates whether or not to cut the media (Web-Fed).
<i>ManualFeed</i> ? New in JDF 1.2	boolean	Indicates whether the media will be fed manually.
<i>MirrorAround</i> ="None"	enumeration	This attribute specifies the axis around which a device SHALL mirror an image if the device is capable of doing so. Allowed value is from: ▶ Axis.
<i>NonPrintableMargin Bottom</i> ? New in JDF 1.3	double	The width of the bottom margin measured inward from the edge of the <i>Media</i> with respect to the idealized process coordinate system of the <i>ImageSetting</i> process. The <i>Media</i> origin is unaffected by <i>@NonPrintableMarginBottom</i> . These margins are independent of the PDL content.
<i>NonPrintableMargin Left</i> ? New in JDF 1.3	double	Same as <i>@NonPrintableMarginBottom</i> except for the left margin.
<i>NonPrintableMargin Right</i> ? New in JDF 1.3	double	Same as <i>@NonPrintableMarginBottom</i> except for the right margin.
<i>NonPrintableMargin Top</i> ? New in JDF 1.3	double	Same as <i>@NonPrintableMarginBottom</i> except for the top margin.
<i>Polarity</i> = "Positive"	enumeration	Definition of the polarity of the image. Allowed value is from: ▶ Polarity.
<i>Punch</i> ? Deprecated in JDF 1.3	boolean	If "true", indicates that the device SHALL create registration punch holes. Use a combined process with a <i>Bending</i> process to specify punching in JDF 1.3 and beyond.
<i>PunchType</i> ? Deprecated in JDF 1.3	string	Name of the registration punch scheme (e.g., <i>Bacher</i>). Use a combined process that includes a <i>Bending</i> process to specify punching in JDF 1.3 and beyond.
<i>Resolution</i> ?	XYPair	Resolution of the output. If not specified, the default is taken from the resolution of the input ByteMap.
<i>RollCut</i> ?	double	Length of media to be cut off of a roll, in points.
<i>Sides</i> = "OneSidedFront" New in JDF 1.2	enumeration	Indicates whether the content layout SHALL be imaged on one or both sides of the media. <i>@Sides</i> SHALL NOT be used unless <i>ImageSetterParams</i> describes output to a proofer. Allowed values are from: ▶ Table 8.127 Sides Attribute Values.
<i>SourceWorkStyle</i> ? New in JDF 1.2	enumeration	When proofing in a "RIP once, output many" (ROOM) workflow, <i>@SourceWorkStyle</i> specifies the direction in which the bytemaps have been prepared for press. The device SHALL use this information to calculate a transformation that results in a proof that is identical to the press sheet. Allowed value is from: ▶ WorkStyle.
<i>TransferCurve</i> ?	Transfer-Function	Area coverage correction of the device.

Table 8.126: ImageSetterParams Resource (Sheet 3 of 3)

NAME	DATA TYPE	DESCRIPTION
FitPolicy ? New in JDF 1.2	element	Describes the hardware image fitting algorithms. Allows printing even if the size of the imagable area of the media does not match the requirements of the data.

Table 8.127: Sides Attribute Values

VALUE	DESCRIPTION
OneSidedBackFlipX	Page content is imaged on the back side of media so that the corresponding page cells back up to a blank front cell when flipping around the X axis. Equivalent to "WorkAndTumble" with a blank front side.
OneSidedBackFlipY	Page content is imaged on the back side of media so that the corresponding page cells back up to a blank front cell when flipping around the Y axis. Equivalent to "WorkAndTurn" with a blank front side.
OneSidedFront	Page content is imaged on the front side of media. This is the only value that is valid for filmsetting and platesetting. The default.
TwoSidedFlipX	Page content is imaged on both the front and back sides of media sheets so that the corresponding page cells back up to each other when flipping around the X axis. Equivalent to "WorkAndTumble".
TwoSidedFlipY	Page content is imaged on both the front and back sides of media sheets so that the corresponding page cells back up to each other when flipping around the Y axis. Equivalent to "WorkAndTurn".

8.75 Ink

Ink describes the ink, primer, toner or varnish that is applied to a substrate when printing or varnishing. Whereas **Color** describes the visual properties of a colorant, **Ink** describes the physical material that is applied to the substrate. The default unit of measurement for **Ink** is @Unit = "g" (gram).

Resource Properties

Resource Class: Consumable
 Example Partition: "FountainNumber", "Separation", "SheetName", "Side", "SignatureName", "WebName"
 Intent Pairing: **ColorIntent**
 Input of Processes: **ConventionalPrinting, DigitalPrinting, Varnishing**

Table 8.128: Ink Resource (Sheet 1 of 2)

NAME	DATA TYPE	DESCRIPTION
ColorName ? Deprecated in JDF 1.4	string	Link to a definition of the color specifics. The value of @ColorName color SHOULD match the @Name attribute of a Color defined in a ColorPool resource that is linked to the process that is using the Ink resource. Instead of linking the ColorPool resource directly, it MAY be referenced by another resource that is linked to the process. Note: A @ColorName attribute is used differently in other resources where it refers to a @NamedColor as defined in ▶ Section A.3.35 NamedColor. Deprecation note: Starting with JDF 1.4 , use @Separation partition key.
Family ?	NMTOKEN	Ink family. Values include: Ink – any ink that is used as a colorant. Primer – any ink that is used as a primer. Varnish – liquid that is similar to ink Toner – liquid that is similar to ink
InkName ?	string	The fully qualified ink name including the ink @Family name. For instance, "PANTONE 138 C" is a member of the PANTONE family.

Table 8.128: Ink Resource (Sheet 2 of 2)

NAME	DATA TYPE	DESCRIPTION
<i>SpecialInk</i> ? Modified in JDF 1.5	NMTOKENS	Specific ink attributes. Values include those from: ▶ Ink and Varnish Coatings.
<i>SpecificYield</i> ?	double	Weight per area at total coverage in g/m ² .

8.76 InkZoneCalculationParams

InkZoneCalculationParams specifies the parameters for the *InkZoneCalculation* process.

Resource Properties

Resource Class: Parameter
 Example Partition: "TileID", "WebName"
 Input of Processes: *InkZoneCalculation*

Table 8.129: InkZoneCalculationParams Resource

NAME	DATA TYPE	DESCRIPTION
<i>FountainPositions</i> ?	DoubleList	Even number of positions. Each pair specifies the beginning and end of the ink slides belonging to a certain fountain. The positions are in coordinates of the printable width along the cylinder axis. The first pair is associated with the first fountain position (corresponds to the partition <i>@FountainNumber="0"</i>), the second pair with the second fountain position (<i>@FountainNumber="1"</i>), etc.
<i>PrintableArea</i> ?	rectangle	Position and size of the printable area of the print cylinder in the coordinates of the <i>Preview</i> resource. The partition <i>@TileID</i> SHALL be used for each plate together with this attribute in case of multiple plates per cylinder. Multiple plates per cylinder MAY be used in web printing. The default case SHALL specify a rectangle that encompasses the complete image to be printed.
<i>ZoneHeight</i> ?	double	The width of one zone in the feed direction of the printing machine being used.
<i>Zones</i> ? Modified in JDF 1.2	integer	The number of ink zones of the press.
<i>ZonesY</i> ?	integer	Number of ink zones in feed direction of the press.
<i>ZoneWidth</i> ? Modified in JDF 1.2	double	The width of one zone of the printing machine being used. The width of a zone SHOULD be the width of an ink slide.
<i>Device</i> ? New in JDF 1.2	refelement	<i>Device</i> provides a reference to the press that the <i>InkZoneProfile</i> is defined for and MAY be used to gather information on ink zone geometry.

8.77 InkZoneProfile

InkZoneProfile specifies ink zone settings that are specific to the geometry of the printing device being used. *InkZoneProfile* elements are independent of the device details.

Resource Properties

Resource Class: Parameter
 Example Partition: "FountainNumber", "Separation", "SheetName", "Side", "SignatureName", "WebName"
 Input of Processes: *ConventionalPrinting*

Output of Processes: **InkZoneCalculation**

Table 8.130: InkZoneProfile Resource

NAME	DATA TYPE	DESCRIPTION
<i>ZoneHeight</i> ?	double	The width of one zone in the feed direction of the printing machine being used.
<i>ZoneSettingsX</i>	DoubleList	Each entry of the <i>@ZoneSettingsX</i> attribute is the value of one ink zone in the X direction. The first entry is the first zone, and the number of entries equals the number of zones of the printing device being used. Allowed values are in the range [0, 1] where 0 SHALL specify no ink and 1 SHALL specify 100% coverage.
<i>ZoneSettingsY</i> ?	DoubleList	Each entry of the <i>@ZoneSettingsY</i> attribute is the value of one ink zone in the Y direction. The first entry is the first zone, and the number of entries equals the number of zones of the printing device being used. Allowed values are in the range [0, 1] where 0 SHALL specify no ink and 1 SHALL specify 100% coverage.
<i>ZoneWidth</i>	double	The width of one zone of the printing machine being used. Typically, the width of a zone is the width of an ink slide.

8.78 InsertingParams

InsertingParams specifies the parameters for the **Inserting** process. ▶ Table 8.132 Location of Inserts shows the various components involved in an inserting process, and how they interact.

Resource Properties

Resource Class: **Parameter**

Intent Pairing: **BindingIntent, InsertingIntent**

Input of Processes: **Inserting**

Table 8.131: InsertingParams Resource





NAME	DATA TYPE	DESCRIPTION
<i>FinishedPage</i> ? New in JDF 1.2	integer	Finished page number of the mother Component on which the child Component SHALL be placed. <i>@FinishedPage</i> SHALL NOT be specified unless <i>@InsertLocation="FinishedPage"</i> . Corresponds to <i>InsertingIntent/@Folio</i> .
<i>InsertLocation</i> Modified in JDF 1.2	enumeration	Where to place the “child” sheet. Allowed values are: Back FinishedPage – Place the child exactly onto the page specified in <i>@FinishedPage</i> . New in JDF 1.2 Front Overfold – Place onto the overfold side. Replaces “OverfoldLeft” and “OverfoldRight”. New in JDF 1.2 OverfoldLeft – Deprecated in JDF 1.2 OverfoldRight – Deprecated in JDF 1.2 Modification note: Starting with JDF 1.2, this attribute is renamed from <i>@Location</i> due to a name clash with the <i>@Location</i> partition key.
<i>Method = "BlowIn"</i>	enumeration	Inserting method. Allowed values are: BindIn – Apply glue to fasten the insert. BlowIn – Loose insert.
<i>SheetOffset</i> ? Deprecated in JDF 1.1	XYPair	Offset between the sheet to be inserted and the “mother” sheet. <i>@SheetOffset</i> is implied by the transformation matrix in <i>ResourceLink/@Transformation</i> of the child’s <i>ComponentLink</i> .
<i>GlueLine</i> *	element	Array of all <i>GlueLine</i> elements. The coordinate system is defined by the mother Component .

Location of Inserts

New in JDF 1.2

The following graphics depict the various values of *InsertingParams/@InsertLocation*:

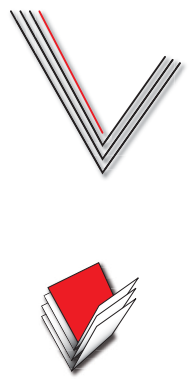
Table 8.132: Location of Inserts

FRONT	BACK	OVERFOLD	FINISHED PAGE
			
<p>Child on "Front" of mother component — is used for fixed inserts (e.g., gluing of inserts and so forth on signatures).</p>	<p>Child on "Back" of mother component — is used for fixed inserts (e.g., gluing of inserts on signatures).</p>	<p>The mother component is opened at the overfold and the child is placed in the center of the mother. "Overfold" is used for loose inserts (e.g., inserts into newspapers).</p>	<p>Child on "FinishedPage" X of mother component — can be used for loose and fixed inserts.</p>

8.79 InterpretedPDLData

Represents the results of the **Interpreting** or **RasterReading** process. The details of this resource are not specified, as it is assumed to be implementation dependent.

Resource Properties

Resource Class: **Parameter**

Resource referenced by: **RunList**

8.80 InterpretingParams

InterpretingParams contains the parameters needed to interpret PDL pages. **InterpretingParams** itself is a generic resource that contains attributes that are relevant to all PDLs. PDL-specific details resources MAY be included as subelements of this generic resource. This specification defines one additional PDL-specific resource instance:

PDFInterpretingParams.

Resource Properties

Resource Class: **Parameter**

Intent Pairing: **ProofingIntent**

Example Partition: "DocIndex", "RunIndex", "RunTags", "DocTags", "PageTags", "SetTags", "SheetName", "Side", "SignatureName"

Input of Processes: **Interpreting**

Table 8.133: InterpretingParams Resource (Sheet 1 of 3)

NAME	DATA TYPE	DESCRIPTION
<i>Center</i> = "false"	boolean	Indicates whether or not the finished page image SHALL be centered within the imagable area of the media. @Center is ignored if <i>FitPolicy</i> / <i>@SizePolicy</i> ="ClipToMaxPage" and clipping is specified.
<i>FitToPage</i> ? Deprecated in JDF 1.1	boolean	Specifies whether the finished page contents SHALL be scaled to fit the media. In JDF 1.1 and beyond, use <i>FitPolicy</i> .

Table 8.133: InterpretingParams Resource (Sheet 2 of 3)

NAME	DATA TYPE	DESCRIPTION
<i>MirrorAround</i> = "None"	enumeration	This attribute specifies the axis around which a RIP SHALL mirror an image. Note: This is mirroring in the RIP and not in the hardware of the output device. Allowed value is from: ▶ Axis.
<i>Polarity</i> = "Positive"	enumeration	The image SHALL be RIPPed in the specified polarity. Note that this is a polarity change in the RIP and not a polarity change in the hardware of the output device. Allowed value is from: ▶ Polarity.
<i>Poster</i> ? Deprecated in JDF 1.5	XYPair	Specifies whether the page contents SHALL be expanded such that each page covers X by Y pieces of media. Deprecation note: Starting with JDF 1.5, use Tiling instead of @Poster and @PosterOverlap.
<i>PosterOverlap</i> ? Deprecated in JDF 1.5	XYPair	This pair of real numbers identifies the amounts of overlap in points for the poster tiles across the horizontal and vertical axes, respectively. Deprecation note: Starting with JDF 1.5, use Tiling instead of @Poster and @PosterOverlap.
<i>PrintQuality</i> = "Normal" New in JDF 1.1	enumeration	Generic switch for setting the quality of an otherwise inaccessible device. Allowed values are: High – Highest quality available on the printer. Normal – The default quality provided by the printer. Draft – Lowest quality available on the printer.
<i>Scaling</i> ?	XYPair	A pair of positive real values that indicates the scaling factor for the content. Values between 0 and 1 specify that the contents SHALL be reduced, while values greater than 1 specify that the contents SHALL be expanded. Any scaling defined in FitPolicy SHALL be applied after the scaling defined by this attribute.
<i>ScalingOrigin</i> ?	XYPair	A pair of real values that identifies the point in the unscaled PDL page that remains at the same position after scaling. This point is defined in the coordinate system of the PDL page. For example, the @ScalingOrigin of a PDL page with dimensions "300 400" scaled from the PDL page center would be "150 200", regardless of the value of @Scaling. Modification note: Starting with JDF 1.4, 1) the default value MAY be set to an implementation defined value; the default value is no longer specified as "0 0" in this document; 2) the phrase "PDL page" replaces "Page"; 3) this attribute specifies the point which is not shifted when scaling is applied and doesn't specify a new origin (i.e., lower left of the page).
<i>FitPolicy</i> ? New in JDF 1.1	element	Allows printing even if the size of the imagable area of the media does not match the requirements of the data. This replaces the deprecated @FitToPage attribute. This FitPolicy resource SHALL be ignored in a combined process with LayoutPreparation .
<i>InterpretingDetails</i> ? New in JDF 1.5	element	Container for interpreter-specific details.
<i>Media</i> * New in JDF 1.1 Modified in JDF 1.2	refelement	This resource provides a description of the physical media that will be marked. The physical characteristics of the media MAY affect decisions made during Interpreting . The cardinality was changed to "*" in JDF 1.2 in order to support description of multiple media types (e.g., Film, Plate and Paper). If multiple Media are specified, Media/@MediaType defines the type of Media . If multiple Media with Media/@MediaType="Paper" are specified in a proofing environment, the first Media is the proofer paper and the second Media is the final device paper.
<i>ObjectResolution</i> *	element	Indicates the resolution at which the PDL contents will be interpreted in DPI. These elements MAY be different from the ObjectResolution elements provided in the resource.

Table 8.133: InterpretingParams Resource (Sheet 3 of 3)

NAME	DATA TYPE	DESCRIPTION
PDFInterpretingParams ? New in JDF 1.1	element	Details of interpreting for PDF. Note that this is a subelement in JDF 1.1 and beyond, and not an instance as in JDF 1.0.

8.80.1 InterpretingDetails

New in JDF 1.5

[InterpretingDetails](#) contains PDL-specific instructions for an interpreter.

Table 8.134: InterpretingDetails Element

NAME	DATA TYPE	DESCRIPTION
MinLineWidth ?	double	If present, this attribute specifies the minimum width in points for PDL line objects. If a line is defined with a width smaller than this value it SHALL be adjusted to a line width equal to this value. Note: This attribute is useful for managing the consistency of thin lines across different digital printing systems that have varying imaging resolutions.

8.80.2 PDFInterpretingParams

New in JDF 1.1

Table 8.135: PDFInterpretingParams Element (Sheet 1 of 2)

NAME	DATA TYPE	DESCRIPTION
EmitPDFBG = "true"	boolean	Indicates whether BlackGeneration functions SHALL be emitted.
EmitPDFHalftones = "true"	boolean	Indicates whether halftones SHALL be emitted.
EmitPDFTransfers = "true"	boolean	Indicates whether transfer functions SHALL be emitted.
EmitPDFUCR = "true"	boolean	Indicates whether under color removal functions SHALL be emitted.
HonorPDFOverprint = "true"	boolean	Indicates whether or not overprint settings in the file SHALL be honored. If "true", the setting for overprint SHALL be honored. If "false", it is expected that the device does not directly support overprint and that the PDF is pre-processed to simulate the effect of the overprint settings.
ICColorAsDeviceColor = "false"	boolean	Indicates whether colors specified by ICC color spaces are to be treated as device colorants.
OCGDefault = "FromPDF" New in JDF 1.3	enumeration	Specifies whether optional content groups (OCGs or layers) in the PDF being interpreted and not explicitly listed in subsidiary OCGControl subelements, are to be included in the InterpretedPDLData produced by the Interpreting process. Allowed values are: Exclude – All layers not explicitly listed are to be excluded. FromPDF – The guidelines in the PDF reference are to be used to determine whether to include each layer that is not explicitly listed. Include – All layers not explicitly listed are to be included.
OCGIntent ? New in JDF 1.3	NMTOKEN	If @OCGDefault="FromPDF" , then the value of @OCGIntent sets the intent for which OCGs SHALL be selected. Values include: Design – As described in ▶ [PDF1.6]. View – As described in ▶ [PDF1.6].

Table 8.135: PDFInterpretingParams Element (Sheet 2 of 2)

NAME	DATA TYPE	DESCRIPTION
<i>OCGProcess</i> ? New in JDF 1.3	enumeration	If @OCGDefault="FromPDF", then the value of @OCGProcess sets the purpose for which the Interpreting process is being performed. This, in turn, sets which value from a relevant optional content usage dictionary SHALL be used to determine whether each OCG is included in the <i>InterpretedPDLData</i> . Allowed values are: Export – PDF ExportState in the export subdictionary. Print – PDF PrintState in the print subdictionary. View – PDF ViewState in the view subdictionary. Additional values are defined in ▶ [ISO19593-1:2016] or MAY be site specific.
<i>OCGZoom</i> = "1.0" New in JDF 1.3	double	If @OCGDefault="FromPDF", then the value of @OCGZoom sets the magnification that SHALL be assumed in comparisons with the zoom dictionary in a relevant optional content usage dictionary to determine whether each OCG is included in the <i>InterpretedPDLData</i> . A @OCGZoom value of 1.0 corresponds to be a magnification of 100%.
<i>PrintPDFAnnotations</i> = "false" Modified in JDF 1.3	boolean	Indicates whether the contents of annotations on PDF pages SHALL be included in the output. This only refers to annotations that are set to print in the PDF file excluding trap annotations. Trap annotations are controlled with @PrintTrapAnnotations.
<i>PrintTrapAnnotations</i> ? New in JDF 1.3	boolean	Indicates whether the contents of trap annotations on PDF pages SHALL be included in the output.
<i>TransparencyRenderingQuality</i> ?	double	Values are 0 to 1. A value of 0 represents the lowest allowable quality; 1 represents the highest achievable quality.
<i>OCGControl</i> * New in JDF 1.3	element	<i>OCGControl</i> provides a list of the OCGs (layers) that SHALL be explicitly included or excluded in the <i>InterpretedPDLData</i> . Any OCGs not listed in an <i>OCGControl</i> element SHALL follow the rules set by @OCGDefault.
<i>ReferenceXObjectParams</i> ? New in JDF 1.4	element	Describes how the interpreter should handle PDF Reference XObjects.

8.80.3 ReferenceXObjectParams

New in JDF 1.4

Table 8.136: ReferenceXObjectParams Element

NAME	DATA TYPE	DESCRIPTION
<i>Mode</i>	NMTOKEN	Specifies how to handle a Reference XObject's reference. Values include: Ignore – The reference SHALL be ignored, and no content is imaged for that Reference XObject. If proxy content is supplied with the Reference XObject, it SHALL be imaged. ResolveAlways – An attempt SHALL be made to resolve the reference and image the graphics described by that reference. ResolveIfPDFX5 – An attempt SHALL be made to resolve the reference ONLY if the PDF file is a valid PDF/X-5 file, AND the referenced file passes the criteria required by PDF/X-5, see ▶ [ISO15930-8:2010].
<i>FileSpec</i> (SearchPath) *	refelement	An ordered list of search paths to search when an XObject provides a relative file specification for its target file. If not specified, then the directory that contains the PDF file being interpreted will be searched, and SHALL NOT be searched recursively.

8.81 JacketingParams

New in JDF 1.1

Description of the setup of the jacketing machinery. Jacket height and width (1 and 4 in the ▶ Figure 8-30: Setup of the jacketing machinery) are specified within the **Component** that describes the jacket.

Resource Properties

Resource Class: Parameter
 Intent Pairing: **BindingIntent**
 Input of Processes: **Jacketing**

Table 8.137: JacketingParams Resource

NAME	DATA TYPE	DESCRIPTION
<i>FoldingDistance</i> ? New in JDF 1.4	double	Distance from the fold at <i>@FoldingWidth</i> to the other fold. If not specified, it defaults to the width of the jacket minus double the value of <i>@FoldingWidth</i> (symmetrical folds).
<i>FoldingWidth</i>	double	Definition of the dimension of the folding width of the front cover fold, see ▶ Figure 8-31: Parameters and coordinate system for jacketing. All other measurements are implied by the dimensions of the book.

Figure 8-30: Setup of the jacketing machinery

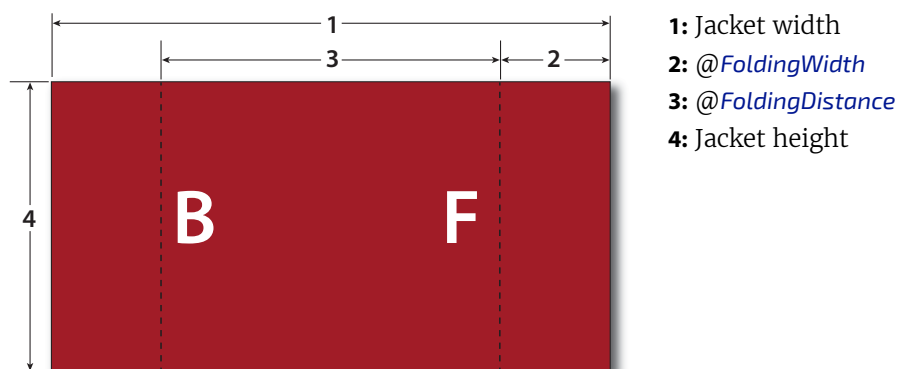
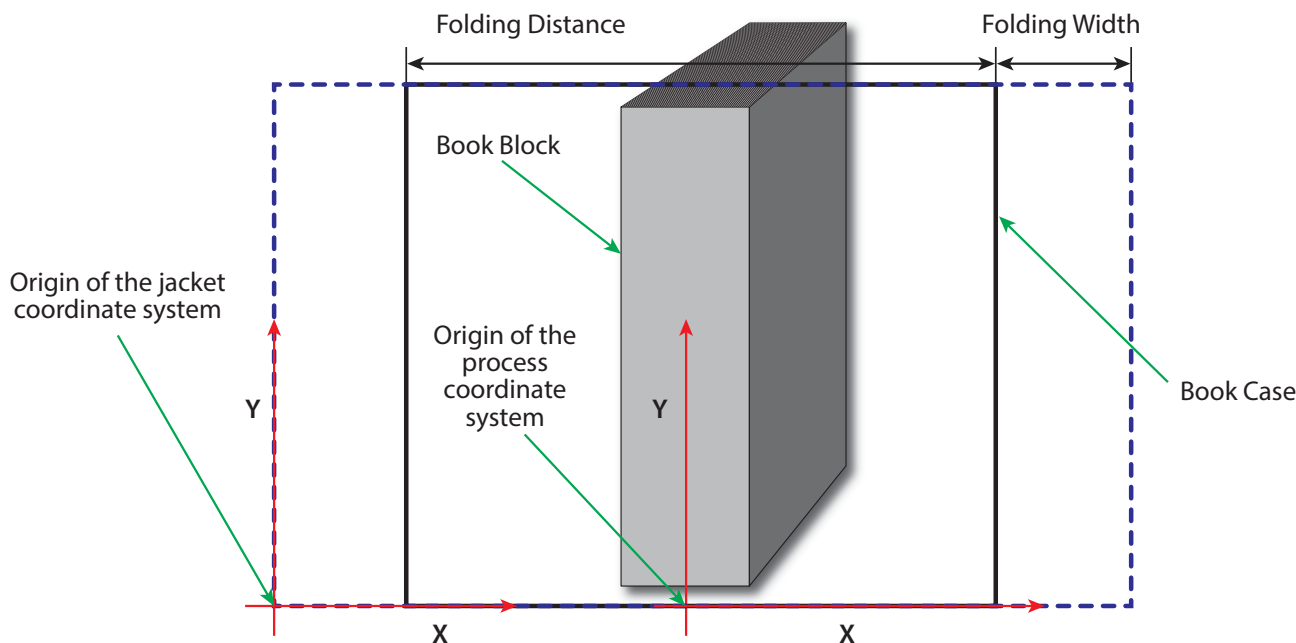

Figure 8-31: Parameters and coordinate system for jacketing



8.82 LabelingParams

New in JDF 1.1

RESOURCES

LabelingParams defines the details of the **Labeling** process.

Resource Properties

Resource Class: Parameter

Input of Processes: **Labeling**

Table 8.138: LabelingParams Resource

NAME	DATA TYPE	DESCRIPTION
<i>Application</i> ?	NMTOKEN	Application method of the label. Values include: Glue – Glued onto the component. Loose – Loosely laid onto the component. SelfAdhesive – Self adhesive label. Staple – Stapled onto the component.
<i>CTM</i> ? Deprecated in JDF 1.6	matrix	Position and orientation of the label lower left corner relative to the lower left corner of the component surface as defined by <i>@Position</i> . Deprecation note: Use <i>@Offset</i> and ComponentLink(Label)/@Orientation .
<i>Offset</i> ? New in JDF 1.6	XYPair	Position of the lower left corner of the label after applying the rotation defined in ComponentLink(Label)/@Orientation relative to the lower left corner of the component surface as defined by <i>@Position</i> .
<i>Position</i> ?	enumeration	Position of the label on the bundle. Allowed value is from: ▶ Face.
<i>FileSpec</i> ? New in JDF 1.5	refelement	A FileSpec resource pointing to an address list. The format of the referenced mailing list is implementation dependent.

8.83 LaminatingParams

New in JDF 1.1

LaminatingParams specifies the parameters needed for laminating.

Resource Properties

Resource Class: Parameter

Intent Pairing: **LaminatingIntent**

Example Partition: "SheetName", "Side"

Input of Processes: **Laminating**

Table 8.139: LaminatingParams Resource (Sheet 1 of 2)

NAME	DATA TYPE	DESCRIPTION
<i>AdhesiveType</i> ?	string	Type of adhesive used. Valid only when <i>@LaminatingMethod</i> ="DispersionGlue".
<i>GapList</i> ?	DoubleList	List of non-laminated gap positions in the X direction of the laminating tool in the coordinate system of the Component . The zero-based even entries define the absolute position of the start of a gap, and the odd entries define the end of a gap. If not specified, the complete area defined by <i>@LaminatingBox</i> is laminated.
<i>HardenerType</i> ?	string	Type of hardener used. Valid only when <i>@LaminatingMethod</i> ="DispersionGlue".
<i>LaminatingBox</i> ? Modified in JDF 1.4	rectangle	Area on the Component that SHALL be laminated. Modification note: Starting with JDF 1.4 , <i>@LaminatingBox</i> becomes optional to enable Laminating yes/no style definitions.
<i>LaminatingMethod</i> ?	enumeration	Laminating technology that SHALL be applied. Allowed values are: CompoundFoil DispersionGlue Fusing – New in JDF 1.3 Unknown – Deprecated in JDF 1.2

Table 8.139: LaminatingParams Resource (Sheet 2 of 2)

NAME	DATA TYPE	DESCRIPTION
<i>ModuleIndex</i> ? New in JDF 1.4	integer	Index of the laminating module in a multi-function device, such as a printing press. See Module for details. In a combined process, all modules of the device, including press modules, finishing modules and varnishing modules are counted to calculate @ModuleIndex .
<i>NipWidth</i> ? New in JDF 1.3	double	Width of the nip in points that SHALL be formed between the fusing rollers and the component in the Laminating process.
<i>Temperature</i> ?	double	Temperature that SHALL be used in the Laminating process.

8.84 Layout

Represents the root of the layout structure. [Layout](#) is used both for fixed-layout and for automated printing.

Resource Properties

Resource Class: Parameter

Resource referenced by: [LayoutIntent](#), [Component](#), [CylinderLayout](#), [InsertSheet](#)

Intent Pairing: [LayoutIntent](#)

Example Partition: "SignatureName", "WebName", "RibbonName", "SheetName", "Side", "PartVersion"

Input of Processes: [ConventionalPrinting](#), [CylinderLayoutPreparation](#), [DigitalPrinting](#), [Imposition](#), [InkZoneCalculation](#)

Output of Processes: [LayoutPreparation](#), [Stripping](#)

Table 8.140: Layout Resource (Sheet 1 of 4)

NAME	DATA TYPE	DESCRIPTION
<i>Automated</i> ?	boolean	If "true", the Imposition process is expected to perform automated imposition. Layout/@Automated SHALL only be specified in the root partition of Layout . Default value is: "false" in the root partition of Layout
<i>BaseOrdReset=</i> <i>"PagePool"</i> New in JDF 1.4	enumeration	Policy on how the @Ord attribute of an entry SHALL be calculated when extracting a page from a RunList and positioning it in the Layout . Allowed values are: PagePool – The ▶ Base Ord is reset to point to the first page entry of the ▶ Page Pool at the beginning of each ▶ Page Pool processed by the ▶ Imposition Template . PagePoolList – At the beginning of processing of the ▶ Imposition Template , the ▶ Base Ord is reset to point to the first page entry of the first ▶ Page Pool to be processed by the ▶ Imposition Template . This results in all ▶ Page Pools that will be processed by the ▶ Imposition Template to be treated as a ▶ Page Pool List .
<i>LockOrigins</i> ?= <i>"false"</i> New in JDF 1.3	boolean	Determines the relationship of the coordinate systems for front and back surfaces. When "false", all contents for all surfaces are transformed into the first quadrant, in which the origin is at the lower left corner of the surface. When "true", contents for the front surface are imaged into the first quadrant (as above), but contents for the back surface are imaged into the second quadrant, in which the origin is at the lower right. This allows the front and back origins to be aligned even if the exact media size is unknown. The @LockOrigins was copied from the deprecated Sheet resource.
<i>MaxCollect</i> ? New in JDF 1.4	integer	Maximum number of sheets that will be collected into a signature. @MaxCollect modifies the pagination when automated imposition is selected. Specifying @MaxCollect can effectively cause a ▶ Page Pool or ▶ Page Pool List to be broken into "sub" ▶ Page Pools . Each of these "sub" ▶ Page Pools provides the set of pages mapped onto a single collect, and are processed sequentially out of the "parent" ▶ Page Pool (or ▶ Page Pool List). Thus each sub- ▶ Page Pool effectively restarts the ord counting within the ▶ Imposition Template (i.e., treat a sub- ▶ Page Pool as if a new ▶ Page Pool were being started with the imposition template). If not specified, all sheets SHALL be collected.

Table 8.140: Layout Resource (Sheet 2 of 4)

NAME	DATA TYPE	DESCRIPTION
<i>MaxDocOrd</i> ="1" New in JDF 1.1 Deprecated in JDF 1.4	integer	Zero-based maximum number of instance documents that are consumed from a <i>RunList</i> each time the <i>Layout</i> is executed, assuming the <i>Imposition</i> process is automated. Deprecation note: See <i>@MaxOrd</i> .
<i>MaxOrd</i> ? Deprecated in JDF 1.4	integer	Zero-based maximum number of placed objects that are consumed from a <i>RunList</i> each time the <i>Layout</i> is executed, assuming the <i>Imposition</i> process is automated. If not specified, it SHALL be calculated from the <i>@Ord</i> values of the <i>ContentObject</i> elements in the <i>Layout</i> . Deprecation note: <i>@MaxOrd</i> has no meaning if negative <i>@Ord</i> values exist in an automated <i>Layout</i> . The consumer SHALL calculate the implied 2 values for increasing and decreasing the explicit <i>@Ord</i> values in an automated <i>Layout</i> by evaluating the actual values of <i>ContentObject/@Ord</i> . Increment from Front = 1+max(<i>ContentObject/@Ord_+</i>) where " <i>@Ord_+</i> " specifies positive values of <i>@Ord</i> ; Decrement from Back = max (abs ((<i>ContentObject/@Ord_-</i>)) where " <i>@Ord_-</i> " specifies negative values of <i>@Ord</i> . See ▶ Section 6.3.18 Imposition for details.
<i>MaxSetOrd</i> ="1" New in JDF 1.1 Deprecated in JDF 1.4	integer	Zero-based maximum number of document sets that are consumed from a <i>RunList</i> each time the <i>Layout</i> is executed, assuming the <i>Imposition</i> process is automated. Deprecation note: See <i>@MaxOrd</i> .
<i>MinCollect</i> ? New in JDF 1.4	integer	Minimum number of sheets that will be collected into a signature. <i>@MinCollect</i> modifies the pagination when automated imposition is selected.
<i>Name</i> ? New in JDF 1.1 Deprecated in JDF 1.4	string	Unique name of the <i>Layout</i> . The <i>@Name</i> is used for external reference to a <i>Layout</i> . Deprecation note: Starting with JDF 1.4, use <i>@DescriptiveName</i> .
<i>NonPrintableMargin Bottom</i> ?	double	The width in points of the bottom margin measured inward from the edge of the paper <i>Media</i> with respect to the idealized process coordinate system of the final printing process. The <i>Media</i> origin is unaffected by <i>@NonPrintableMarginBottom</i> . These margins are independent of the PDL content.
<i>NonPrintableMargin Left</i> ?	double	Same as <i>@NonPrintableMarginBottom</i> except for the left margin.
<i>NonPrintableMargin Right</i> ?	double	Same as <i>@NonPrintableMarginBottom</i> except for the right margin.
<i>NonPrintableMargin Top</i> ?	double	Same as <i>@NonPrintableMarginBottom</i> except for the top margin.
<i>OrdsConsumed</i> ? New in JDF 1.4	IntegerRangeList	Range of <i>@Ord</i> values of the <i>RunList (Document)</i> that are consumed by this <i>Layout</i> section. SHALL NOT be specified unless <i>@Automated</i> ="true".

Table 8.140: Layout Resource (Sheet 3 of 4)

NAME	DATA TYPE	DESCRIPTION
<i>SheetCountReset</i> ? New in JDF 1.4	enumeration	<p>Policy as to when the automated imposition variables <i>@SheetCount</i> and <i>@TotalSheetCount</i> are reset. See ▶ Section 6.3.18.2 Variables for Automated Imposition.</p> <p>Allowed values are:</p> <p><i>Continue</i> – <i>@SheetCount</i> continues to increment for each sheet generated by the current ▶ Imposition Template.</p> <p><i>PagePool</i> – <i>@SheetCount</i> is reset to zero upon start of processing of a new ▶ Page Pool and <i>@TotalSheetCount</i> is determined for that new ▶ Page Pool..</p> <p><i>PagePoolList</i> – <i>@SheetCount</i> is reset to zero upon start of processing of an ▶ Imposition Template, and <i>@TotalSheetCount</i> is recalculated.</p> <p>Note: The value of <i>@TotalSheetCount</i> MAY depend on the sheets generated from successive ▶ Imposition Templates (for example, if the current ▶ Imposition Template has <i>@SheetCountReset</i>="PagePoolList", and the subsequent ▶ Imposition Template has <i>@SheetCountReset</i>="Continue", <i>@TotalSheetCount</i> will include the sheets generated by both ▶ Imposition Templates.</p> <p>Note: <i>@SheetCount</i> and <i>@TotalSheetCount</i> are always reset to zero at the beginning of processing of a set regardless of the value of <i>Layout/</i> <i>@SheetCountReset</i>.</p>
<i>SheetNameFormat</i> ? New in JDF 1.4	string	<p>A formatting string used with <i>@SheetNameTemplate</i> to algorithmically construct <i>@SheetName</i>. <i>@SheetNameFormat</i> and <i>@SheetNameTemplate</i> are used to identify individual parts of the <i>Layout</i> in an automated environment.</p> <p>Allowed values are from: ▶ Appendix H String Generation.</p>
<i>SheetNameTemplate</i> ? New in JDF 1.4	string	<p>A list of values used with <i>@SheetNameFormat</i> to algorithmically construct <i>@SheetName</i>. <i>@SheetNameFormat</i> and <i>@SheetNameTemplate</i> are used to identify individual parts of the <i>Layout</i> in an automated environment.</p> <p>Allowed values are from: ▶ Appendix H String Generation.</p>
<i>SourceWorkStyle</i> ? New in JDF 1.3	enumeration	<p>Indicates which <i>@WorkStyle</i> was used to create the <i>Layout</i>. This is only informative and can be useful when creating double sided proofs.</p> <p>Allowed value is from: ▶ WorkStyle.</p>
<i>SurfaceContentsBox</i> ? New in JDF 1.3	rectangle	<p>This box, specified in <i>Layout</i>-coordinate space, defines the area into which <i>MarkObject</i> or <i>ContentObject</i> elements are distributed. The lower left corner of the rectangle specified by the value of this attribute establishes the coordinate system onto which the content is mapped and SHOULD have a value of "0 0". <i>@SurfaceContentsBox</i> MAY imply clipping.</p> <p>This attribute SHOULD be supplied in order to get predictable placement of content. If this attribute is not supplied, a rectangle with the origin at "0 0" and an extent that MAY be dependent on the dimensions of one of the <i>Media</i> is implied.</p>
<i>TemplateType</i> = "Normal" New in JDF 1.4	enumeration	<p>Specifies the type of automated ▶ Imposition Template being defined. If <i>@TemplateType</i>="ConditionalSheets", then this ▶ Imposition Template SHALL only specify conditional sheet definitions (see <i>Layout/SheetCondition</i>). Typically, such an ▶ Imposition Template defines conditional sheets to be generated at the beginning and/or end of job and/or set. SHALL ONLY be specified if <i>Layout/</i><i>@Automated</i>="true".</p> <p>Allowed values are:</p> <p><i>ConditionalSheets</i> – the ▶ Imposition Template contains ONLY conditional sheet definitions</p> <p><i>Normal</i> – the ▶ Imposition Template contains at least one sheet definition that consumes pages from the <i>RunList</i> (Document), and may contain conditional sheet definitions. If this value is specified in a partition leaf, this leaf SHALL NOT contain conditional sheet definitions.</p>

Table 8.140: Layout Resource (Sheet 4 of 4)

NAME	DATA TYPE	DESCRIPTION
InsertSheet * Deprecated in JDF 1.4	refelement	Additional sheets that are to be inserted before and/or after a document. Depending on which partition level the InsertSheet is defined, it specifies how to complete the sheet or surface in an automated printing environment. Deprecation note: Starting with JDF 1.4 , use Layout/PageCondition for "FillSheet", "FillSurface", and "FillSignature" operations; use Layout/SheetCondition for an insert sheet.
LayerList ? New in JDF 1.1	element	List of LayerDetails elements.
LogicalStackParams ? New in JDF 1.4	element	When specified, configures the imposition engine to place content onto one or more ▶ Logical Stacks distributed on a common set of sheets. Layout/LogicalStackParams SHALL only be specified in the root Layout element AND only when Layout/@Automated="true" . All ▶ Logical Stacks defined by LogicalStackParams SHALL be used in all ▶ Imposition Templates. See ▶ Section 6.3.18.4.1 Using Logical Stacks.
Media * New in JDF 1.1 Modified in JDF 1.3	refelement	Describes the media to be used. If multiple Media are specified, Media/@MediaType species the type of Media , typically Paper, Plate or Film. Multiple Media with the same Media/@MediaType SHALL NOT be specified in one Layout . Note that at least one Media SHALL be specified in the partitioned Layout tree in JDF 1.3 or above.
MediaSource ? Deprecated in JDF 1.1	refelement	Describes the media to be used. Replaced by Media in JDF 1.1 .
PageCondition * New in JDF 1.4	element	The PageCondition elements are used only with automated imposition. They define restrictions on which page content MAY be placed in a Layout/ContentObject . If any PageCondition restricts placing a page into a ContentObject , the page SHALL NOT be placed into that ContentObject .
PlacedObject * New in JDF 1.3	element	Provides a list of the PlacedObject (i.e., ContentObject and MarkObject) elements to be placed onto the surface. Contains the marks on the surface in rendering order. All PlacedObject elements SHALL be specified in the partition leaves of the Layout . See ▶ Section 8.84.17.1.2 Position of PlacedObject Elements in Layout. Note: PlacedObject is not a container but an abstract type.
SheetCondition ? New in JDF 1.4	element	Specifies the conditions under which the optional sheet defined by this Layout SHALL be produced. SheetCondition SHALL only be present when Layout/@Automated="true" .
Signature * Deprecated in JDF 1.3	element	The Signature element has been replaced by a Layout partition, namely Layout [@SignatureName] . In JDF 1.3 and beyond, Signature/@Name has been replaced by the partition key Layout/@SignatureName .
TransferCurvePool ? New in JDF 1.1	refelement	Describes the relationship of transfer curves and coordinate systems within the various processes.

8.84.1 CIELABMeasuringField

Information about a color measuring field. The color is specified as a CIE-L*a*b* value.

Table 8.141: CIELABMeasuringField Element (Sheet 1 of 2)

NAME	DATA TYPE	DESCRIPTION
Center	XYPair	Position of the center of the color measuring field in the coordinates of the MarkObject that contains this mark. If the measuring field is defined within a ColorControlStrip , @Center refers to the rectangle defined by @Center and @Size of the ColorControlStrip .
CIELab	LabColor	L*a*b* color specification.

Table 8.141: CIELABMeasuringField Element (Sheet 2 of 2)

NAME	DATA TYPE	DESCRIPTION
<i>DensityStandard</i> ? Deprecated in JDF 1.1	enumeration	Density filter standard used during density measurements. Allowed values are: ANSIA – ANSI Status A ANSIE – ANSI Status E ANSII – ANSI Status I ANSIT – ANSI Status T. DIN16536 DIN16536NB Deprecation note: Starting with JDF 1.1, use ColorMeasurementConditions/@DensityStandard .
<i>Diameter</i> ? Modified in JDF 1.1	double	Diameter of the measuring field.
<i>Light</i> Deprecated in JDF 1.1	NMTOKEN	Type of light. Values include: D50 D65
<i>Observer</i> ? Deprecated in JDF 1.1	integer	Observer in degree (2 or 10). In JDF 1.1 and beyond, use ColorMeasurementConditions/@Observer .
<i>Percentages</i> ?	DoubleList	Percentage values for each separation. The number of array elements SHALL match the number of separations.
<i>ScreenRuling</i> ?	DoubleList	Screen ruling values in lines per inch for each separation. The number of array elements SHALL match the number of separations.
<i>ScreenShape</i> ?	string	Shape of screening dots.
<i>Setup</i> ? Deprecated in JDF 1.1	string	Description of measurement setup. Deprecation note: Starting with JDF 1.1, use details from ColorMeasurementConditions
<i>Tolerance</i> ? Modified in JDF 1.1	double	Tolerance in ΔE.
ColorMeasurementConditions ? New in JDF 1.1	refelement	Detailed description of the measurement conditions for color measurements.

8.84.2 ColorControlStrip

[ColorControlStrip](#) describes a color control strip. The type of the color control strip is given in the [@StripType](#) attribute. The lower left corner of the control strip box is used as the origin of the coordinate system used for the definition of the measuring fields. Its coordinates (x_0 , y_0) can be calculated using the following formula:

$$x_0 = x - \frac{w}{2} \cos(\varphi) + \frac{h}{2} \sin(\varphi)$$

$$y_0 = y - \frac{w}{2} \sin(\varphi) + \frac{h}{2} \cos(\varphi)$$

Where:

x = X element of the [@Center](#) attribute

y = Y element of the [@Center](#) attribute

w = X element of the [@Size](#) attribute

h = Y element of the [@Size](#) attribute

φ = Value of the [@Rotation](#) attribute

Table 8.142: ColorControlStrip Element

NAME	DATA TYPE	DESCRIPTION
<i>Center</i> ? Modified in JDF 1.4	XYPair	Position of the center of the color control strip in the coordinates of the MarkObject that contains this mark. Modification note: Starting with JDF 1.4, @Center is optional.

Table 8.142: ColorControlStrip Element

NAME	DATA TYPE	DESCRIPTION
<i>Rotation</i> ? Modified in JDF 1.4	double	Rotation in degrees. Positive graduation figures indicate counter-clockwise rotation; negative figures indicate clockwise rotation.
<i>Size</i> ? Modified in JDF 1.4	XYPair	Size, in points, of the color control strip. Modification note: Starting with JDF 1.4, @Size is optional.
<i>StripType</i> ? Modified in JDF 1.5	string	Type of color control strip. This attribute MAY be used for specifying a pre-defined, company-specific color control strip. Modification note: Starting with JDF 1.5, the data type of this attribute was changed from NMTOKEN to string.
<i>CIELABMeasuringField</i> * New in JDF 1.1	element	Details of a CIELAB measuring field that is part of this <i>ColorControlStrip</i> .
<i>DensityMeasuringField</i> * New in JDF 1.1	refelement	Details of a density measuring field that is part of this <i>ColorControlStrip</i> .
<i>SeparationSpec</i> * New in JDF 1.4	element	Ordered list of separations that comprise the <i>ColorControlStrip</i> . If neither <i>CIELABMeasuringField</i> nor <i>DensityMeasuringField</i> are specified, the geometry is implied by the value of @StripType.

8.84.3 ContentObject

ContentObject elements identify containers for page content on a surface. They SHALL be filled from the content *RunList* of the *Imposition* process. For print applications where page count varies from instance document to instance document, imposition templates can automatically assign pages to the correct surface and *PlacedObject* position.

Table 8.143: ContentObject Element

NAME	DATA TYPE	DESCRIPTION
<i>DocOrd</i> ? New in JDF 1.1	integer	Reference to an index of an instance document in the content <i>RunList</i> . This references an instance document with an index module. <i>Layout</i> /@MaxDocOrd equals @DocOrd in an automated layout scenario. The index can either be known explicitly from a variable <i>RunList</i> or implicitly from the index within an indexable content definition language (e.g., PPML).
<i>ID</i> ? New in JDF 1.5	ID	Identifier for referencing this <i>ContentObject</i> from <i>MarkObject</i> /@ContentRef.
<i>Ord</i> ? Modified in JDF 1.4	integer	A zero-based reference to an index in the content <i>RunList</i> . The index is incremented for every page of the <i>RunList</i> with @IsPage="true". The @Ord value of the first page of a <i>RunList</i> has the value "0". If <i>Layout</i> /@Automated="true", @Ord MAY be a negative integer in a <i>ContentObject</i> . In this case, the explicit @Ord for each iteration of the automated <i>Layout</i> is calculated by subtracting the appropriate number of @Ord values from the back of the document. For details on automated <i>Layout</i> , see ▶ Section 6.3.18 Imposition.
<i>OrdExpression</i> ?	string	Function to calculate an @Ord value dynamically, using a value of <i>s</i> for signature number and <i>n</i> for total number of pages in the instance document. The @Ord or @DocOrd and @OrdExpression are mutually exclusive in one <i>PlacedObject</i> . Value format is from: ▶ Section 8.84.17.5 Using Expressions in the OrdExpression Attribute.
<i>SetOrd</i> ? New in JDF 1.1	integer	A non-negative, zero-based reference to an index of a document set in the content <i>RunList</i> . This references an instance document with an index module. <i>Layout</i> /@MaxSetOrd=@SetOrd in an automated layout scenario. The index can either be known explicitly from a variable <i>RunList</i> or implicitly from the index within an indexable content definition language (e.g., PPML).

8.84.4 DensityMeasuringField

DensityMeasuringField contains information about a density measuring field.

Table 8.144: DensityMeasuringField Element

NAME	DATA TYPE	DESCRIPTION
<i>Center</i>	XYPair	Position of the center of the density measuring field in the coordinates of the MarkObject that contains this mark. If the measuring field is defined within a ColorControlStrip , @Center SHALL refer to the rectangle defined by @Center and @Size of the ColorControlStrip .
<i>Density</i> Modified in JDF 1.1A	DoubleList	Density value for each process color measured with filter. The data type was modified to NumberList in JDF 1.1A in order to accommodate density values >1.0. The sequence of colors SHALL be C M Y K, as in the data type CMYKColor.
<i>Diameter</i>	double	Diameter of the density measuring field.
<i>DotGain</i>	double	Percentage of dot gain.
<i>Percentage</i>	double	Film percentage or equivalent.
<i>Screen</i>	string	Description of the screen.
<i>Separation</i>	string	Reference to a separation that this DensityMeasuringField applies to. When DensityMeasuringField is used as an element, it is a standard attribute, otherwise when DensityMeasuringField is used as a resource, @Separation SHALL be defined as a @Separation partition key.
<i>Setup ?</i>	string	Description of measurement setup.
<i>ToleranceBlack</i>	XYPair	Upper and lower black measurement limits (in density units).
<i>ToleranceCyan</i>	XYPair	Upper and lower cyan measurement limits (in density units).
<i>ToleranceDotGain</i>	XYPair	Upper and lower measurement limits (in%).
<i>ToleranceMagenta</i>	XYPair	Upper and lower magenta measurement limits (in density units).
<i>ToleranceYellow</i>	XYPair	Upper and lower yellow measurement limits (in density units).
ColorMeasurementConditions ? New in JDF 1.1	refelement	Detailed description of the measurement conditions for color measurements.

8.84.5 DynamicField

DynamicField provides a description of dynamic text replacements for a **MarkObject** element. This element SHALL be used for production purposes such as defining bar codes for variable data printing. **DynamicField** elements are not intended as a placeholders for actual content such as addresses. Rather, they are marks with dynamic data such as time stamps and database information. Dynamic objects are **MarkObject** elements with additional OPTIONAL **DynamicField** elements that define text replacement.

Table 8.145: DynamicField Element (Sheet 1 of 2)

NAME	DATA TYPE	DESCRIPTION
<i>Format</i>	string	Format string in C printf format that defines the replacement. Values are from: ▶ Appendix H String Generation.
<i>InputField ?</i> Deprecated in JDF 1.1	string	String that SHALL be replaced by the DynamicInput element in the contents RunList referenced by @Ord or @OrdExpression.
<i>Ord ?</i> Deprecated in JDF 1.4	integer	Reference to an index in the contents RunList that contains DynamicInput elements. Constraint: At most one of @Ord or @OrdExpression SHALL be specified. Deprecation note: Starting with JDF 1.4, @Ord SHALL be specified in the parent MarkObject element.

Table 8.145: DynamicField Element (Sheet 2 of 2)

NAME	DATA TYPE	DESCRIPTION
<i>OrdExpression</i> ? Deprecated in JDF 1.4	string	Expression to calculate the reference to an index in the contents <i>RunList</i> that contains <i>DynamicInput</i> fields. Values format is from: ▶ Section 8.84.17.5 Using Expressions in the OrdExpression Attribute. Constraint: At most one of @Ord or @OrdExpression SHALL be specified.
<i>ReplaceField</i> ?	string	String that SHALL be replaced by the instantiated text expression as defined by the @Format and @Template attributes in the file referenced by <i>MarkObject</i> /@Ord, <i>MarkObject</i> /@OrdExpression or <i>MarkObject</i> /LayoutElement. If @ReplaceField is not specified, the device that processes the <i>DynamicField</i> SHALL format the <i>DynamicField</i> .
<i>Template</i>	string	Template to define a sequence of variables consumed by @Format. Allowed values are from: ▶ Appendix H String Generation. Deprecation note: Starting with JDF 1.4, <i>RunList</i> / <i>DynamicInput</i> /@Name (mentioned here in JDF 1.3) no longer defines further variables because <i>DynamicInput</i> has been deprecated.
<i>DeviceMark</i> ? New in JDF 1.1 Deprecated in JDF 1.4	element	<i>DeviceMark</i> defines the formatting parameters for the mark. If not specified, the <i>DeviceMark</i> settings defined in <i>LayoutPreparationParams</i> or in the <i>Layout</i> tree are assumed.

Example 8.19: Layout: DynamicField Element

In this example the text “__xxx__” in the file MyReplace.pdf would be replaced by the sentence “Replacement Text for Joe and John go in here at 14:00 on Mar-31-2000”. MyReplace.pdf is placed at the position defined by the @CTM of the *MarkObject* and Variable.pdf is placed at the position defined by the @CTM of the *ContentObject*.

```
<RunList Class="Parameter" ID="L3" PartIDKeys="Run" Status="Available">
  <MetadataMap DataType="string" Name="i1" ValueFormat="%s" ValueTemplate="s1">
    <!--This expression maps the value of /Dokument/Rezipient/@Name to a
      variable "s1"-->
    <Expr Name="s1" Path="/Dokument/Rezipient/@Name"/>
  </MetadataMap>
  <LayoutElement ElementType="Graphic">
    <FileSpec URL="File:///Variable.pdf"/>
  </LayoutElement>
</RunList>
<Layout Class="Parameter" ID="Link0003" Status="Available">
  <!--The MarkObject in the Layout hierarchy: -->
  <ContentObject CTM="1 0 0 1 0 0" Ord="0"/>
  <MarkObject CTM="1 0 0 1 10 10">
    <LayoutElement ElementType="Graphic">
      <FileSpec URL="File:///MyReplace.pdf"/>
    </LayoutElement>
    <DynamicField
      Format="Replacement Text for %s goes in here at %s on %s"
      Ord="0" ReplaceField="__xxx__" Template="i1,Time,Date"/>
    <DynamicField Format="More Replacement Text for %s go in here"
      Ord="0" ReplaceField="__yyy__" Template="SignatureName"/>
  </MarkObject>
</Layout>
```

8.84.6 FillMark

New in JDF 1.5

Table 8.146: FillMark Element (Sheet 1 of 2)

NAME	DATA TYPE	DESCRIPTION
<i>KnockoutBleed</i> ?	double	Bleed in points that the fill SHALL grow into (positive values) from the knockout area. Note: This attribute implies the same bleed for all separations.

Table 8.146: FillMark Element (Sheet 2 of 2)

NAME	DATA TYPE	DESCRIPTION
<i>KnockoutRefs</i> ?	IDREFS	Reference to the <i>PlacedObject</i> elements that SHALL not be filled by this <i>FillMark</i> . The knockout boundaries are defined by the value of <i>@KnockoutSource</i> .
<i>KnockoutSource</i>	enumeration	Definition of the source of the knockout from the referenced <i>PlacedObject</i> elements. Allowed values are: <i>ClipPath</i> – Use the clip path as defined by the referenced <i>PlacedObject</i> / <i>@ClipPath</i> . <i>SourceClipPath</i> – Use the clip path as defined by the referenced <i>PlacedObject</i> / <i>@SourceClipPath</i> . <i>TrimClipPath</i> – Use the clip path as defined by the referenced <i>PlacedObject</i> / <i>@TrimClipPath</i> . <i>TrimBox</i> – Use the clip path as defined by the referenced <i>PlacedObject</i> / <i>@TrimCTM</i> and <i>PlacedObject</i> / <i>@TrimSize</i> .
<i>MarkColor</i> *	element	Definition of the separations used to fill the mark.

8.84.7 LayerDetails

New in JDF 1.1

This element provides information about individual layers.

Table 8.147: LayerDetails Element

NAME	DATA TYPE	DESCRIPTION
<i>Name</i> ?	string	Unique name of the layer.

8.84.8 LayerList

New in JDF 1.1

This element provides a container for an ordered list of *LayerDetails* elements. The individual elements are referenced by their zero-based index in the *LayerList* using the *@LayerIDs* partition key.

Table 8.148: LayerList Element

NAME	DATA TYPE	DESCRIPTION
<i>LayerDetails</i> *	element	Details of the individual layers.

8.84.9 LogicalStackParams

New in JDF 1.4

Table 8.149: LogicalStackParams Element (Sheet 1 of 2)

NAME	DATA TYPE	DESCRIPTION
<i>MaxStackDepth</i> ?	integer	Maximum number of imposed sheets to generate as an ▶ Imposed Sheet Set (the size of the ▶ Logical Stack). Implementations SHALL generate the minimum stack size to accommodate the available number of ▶ Logical Sheets if the total number of required sheets for the last stack is smaller than <i>@MaxStackDepth</i> .

Table 8.149: LogicalStackParams Element (Sheet 2 of 2)

NAME	DATA TYPE	DESCRIPTION
<i>Restrictions</i> ="None"	enumeration	Describes any restrictions set on the placement of a ▶ Recipient Set's ▶ Logical Sheets within or across ▶ Imposed Sheet Sets. Allowed values are: <i>None</i> – A recipient set's ▶ Logical Sheets may be placed across both ▶ Logical Stacks and ▶ Imposed Sheet Sets. <i>WithinImposedSheetSet</i> – A ▶ Recipient Set's ▶ Logical Sheets SHALL be placed within a single ▶ Imposed Sheet Set. <i>WithinLogicalStack</i> – A ▶ Recipient Set's ▶ Logical Sheets SHALL be placed within a single ▶ Logical Stack.
<i>Stack</i> +	element	Describes parameters to control the sequencing of ▶ Logical Sheets onto individual ▶ Logical Stacks.

8.84.10 MarkActivation

New in JDF 1.4

MarkActivation specifies the condition of when to apply the mark in an automated *Layout*.

Table 8.150: MarkActivation Element

NAME	DATA TYPE	DESCRIPTION
<i>Context</i>	NMTOKEN	The context in which the iteration is counted. Values include: <i>CollectSheetIndex</i> – a parameter maintained by the imposition engine to count sheets (e.g., in the context of a signature). Its value starts at 0 and is incremented by one for each sheet. If <i>Layout/@MaxCollect</i> is specified, its maximum value is one less than <i>Layout/@MaxCollect</i> . Otherwise, it continues to increment per sheet until completion of the page-pool/page-pool-list processing through the ▶ Imposition Template. See ▶ Section 6.3.18 Imposition. <i>DocIndex</i> – A partition key. <i>SetDocIndex</i> – A partition key. <i>SetIndex</i> – A partition key. <i>SheetIndex</i> – A partition key. <i>SubDocIndex0, ...</i> – A parameter maintained by the imposition engine. See ▶ Section 6.3.18 Imposition.
<i>Index</i>	IntegerRangeList	The enclosing <i>MarkObject</i> is active and its specified mark SHALL be imaged if the value of the variable specified by <i>@Context</i> is equal to one of the values of this attribute.

8.84.10.1 Dynamic Marks

JobField and *@Ord* are mutually exclusive within one *MarkObject*.

The elements marked as dynamic marks in the table above can be used for three purposes:

- If *@Ord* is specified, the PDL of the mark is provided by the *RunList (Marks)* and the dynamic mark subelement subelements provide metadata about the mark to a press controller or bindery equipment. This is the usual behavior of existing imposition engines. A single *MarkObject* SHALL NOT contain multiple mark subelements that are represented by the same PDL, for instance there MAY be only one marks layer for an entire surface.
- If *@Ord* is not present, but *JobField* is present, an imposition device SHOULD dynamically generate the mark based on information in *JobField*.
- If none of *@Ord* and *JobField* are present, a mark SHOULD be dynamically drawn based on the information within the subelement. The marks are positioned relative to the *@CTM* of the *MarkObject*. A single *MarkObject* SHOULD NOT contain multiple dynamic mark subelements. Note that the **JDF** specification of dynamic marks other than *JobField* are in flux and that the behavior described here might change in future versions of **JDF**.

8.84.11 MarkObject

MarkObject elements identify containers for production marks on a surface. If the containing **Layout** is used as an input to **Imposition**, then the PDL SHOULD exist and the marks SHOULD be filled from the **RunList (Marks)** of the **Imposition** process. The content data in individual **MarkObject** elements MAY contain multiple logical marks.

Table 8.151: MarkObject Element (Sheet 1 of 2)

NAME	DATA TYPE	DESCRIPTION
ContentRef ? New in JDF 1.4	IDREF	@ ContentRef refers to the ContentObject that this MarkObject is related to. @ ContentRef is used to define the object that metadata for generating dynamic marks MAY be extracted from.
LayoutElementPageNum ? New in JDF 1.1 Modified in JDF 1.3 Deprecated in JDF 1.4	integer	Page number to use from the PDL file described by LayoutElement . Modification note: Starting with JDF 1.3 , the default value of "0" is removed. Deprecation note: Starting with JDF 1.4 , PDL for marks SHOULD be referenced via RunList (Marks) .
Ord ? Modified in JDF 1.4	integer	A non-negative reference to an index in the RunList (Marks) . The index is incremented for every page of the RunList with @ IsPage ="true". The first page of a RunList has the value 0. Modification note: Starting with JDF 1.4 , at most one of @ Ord or DeviceMark SHALL be specified. For JDF 1.3 only, at most one of LayoutElement , @ Ord or JobField SHALL be specified.
CIELABMeasuringField *	element	CIELABMeasuringField describes a mark for measuring color accuracy in the CIE L*a*b* color space.
ColorControlStrip * Modified in JDF 1.1	refelement	ColorControlStrip describes a color control strip.
CutMark * Modified in JDF 1.1	refelement	CutMark describes cut marks on a sheet.
DensityMeasuringField Modified in JDF 1.1	refelement	DensityMeasuringField describes a mark for measuring ink density.
DeviceMark ? New in JDF 1.4	element	DeviceMark specifies all formatting options for dynamic marks. JobField/DeviceMark specifies the formatting parameters of the JobField and all other dynamically generated marks are positioned with @ CTM . Constraint: At most one of @ Ord or DeviceMark SHALL be specified. Creation note: Starting with JDF 1.4 , DeviceMark is reintroduced after being deprecated in JDF 1.3 .
DynamicField *	element	Definition of text replacement for a MarkObject . MarkObject/DynamicField specifies text replacement within an existing PDL mark.
FillMark * New in JDF 1.5	element	Specifies marks that define a fill layer, e.g., for backlit displays.
IdentificationField *	refelement	Specific information about this kind of mark object. See below for information regarding dynamically generated marks.
JobField ? New in JDF 1.1 Modified in JDF 1.4	element	JobField specifies the metadata of a given dynamic slug line. Modification note: Starting with JDF 1.4 , the maximum number of JobField elements per MarkObject is limited to 1; previously, there was no limit. For JDF 1.3 only, at most one of LayoutElement , @ Ord or JobField SHOULD be specified.
LayoutElement ? Deprecated in JDF 1.4	refelement	PDL description of the mark. The LayoutElement and @ Ord are mutually exclusive within one MarkObject . Modification note: For JDF 1.3 only, at most one of LayoutElement , @ Ord or JobField SHALL be specified. Deprecation note: Starting with JDF 1.4 , PDL for marks SHALL be referenced via RunList(Marks) .

Table 8.151: MarkObject Element (Sheet 2 of 2)

NAME	DATA TYPE	DESCRIPTION
MarkActivation * New in JDF 1.4	element	Rules about when to apply the mark in an automated Layout . If no MarkActivation is specified, the MarkObject is unconditionally active. If multiple MarkActivation elements are specified, all conditions SHALL be met for the mark to be active. MarkActivation SHALL NOT be specified unless Layout/@Automated="true" .
RefAnchor ? New in JDF 1.4	element	Details of the coordinate system that this mark is placed relative to. This MAY be either the sheet coordinate system or the coordinate system of a referenced PlacedObject . If the anchor point in the referenced object (PlacedObject or sheet surface) is modified (e.g., due to a change in @TrimSize), the CTM of the placed object of this DeviceMark SHALL be modified accordingly. Note: RefAnchor does NOT modify the origin of the CTM of this PlacedObject . It is only used to recalculate relative shifts.
RegisterMark * Modified in JDF 1.1	refelement	RegisterMark describes a register mark that can be used to measure color registration.
ScavengerArea * New in JDF 1.1	refelement	ScavengerArea describes a scavenger area for removing excess ink from printed sheets.

8.84.12 PageCondition

New in JDF 1.4

The **PageCondition** element defines restrictions on when page content SHALL NOT be placed in a **ContentObject** of a **Layout**. Before placing page content from a **RunList** into a **ContentObject** the **PageCondition/@RestrictedContentObjects** attribute SHALL be checked for the **@Ord** of the **ContentObject**. If the **@Ord** of the **ContentObject** is in the **@RestrictedContentObjects** attribute value, the alternate content, if any, SHALL be placed in the **ContentObject**. After skipping a restricted **ContentObject**, the **Imposition** process SHALL then place the current page content into the location defined by the next **ContentObject** (after that specified by the **@RestrictedContentObject**). This corresponds to incrementing the effective **@Ord** value of the page in the **RunList** by 1, effectively incrementing the total number of pages of the **RunList**. If the next **ContentObject** is also restricted, then the process is repeated. **PageCondition** elements are processed in their XML order.

Table 8.152: PageCondition Element

NAME	DATA TYPE	DESCRIPTION
Condition ?	enumeration	Specifies the conditions when the PageCondition applies. Condition SHALL NOT be specified if Part elements are present. Allowed values are: PagePoolStart – the condition is true when the @Ord refers to the first page of a ▶ Page Pool in the RunList . PagePoolEnd – after processing of the ▶ Page Pool is completed, the condition is true for all unused @Ord positions in the current collect. PagePoolListStart – the condition is true when the @Ord refers to the first page of an aggregated set of ▶ Page Pools in the RunList . PagePoolListEnd – after processing of the ▶ Page Pool list is completed, the condition is true for all unused ord positions in the current collect.
RestrictedContentObjects	IntegerList	List of @Ord values of those ContentObject elements into which page content that matches the conditions as specified in Part or PageCondition/@Condition SHALL NOT be placed.
Part *	element	Specifies the conditions when the PageCondition applies. Multiple Part elements specify alternate page conditions (ORing of them). Part elements SHALL NOT be specified if @Condition is present.
RunList ?	refelement	Alternate page content that SHALL be placed into the ContentObject elements that are specified in @RestrictedContentObjects when the PageCondition evaluates to "true". The first page of the referenced RunList SHALL be used. Note: The behavior of providing alternate content using RunList is defined only if @Condition is specified.

Example 8.20: PageCondition

New in JDF 1.4

```
<Layout BaseOrdReset="PagePoolList" Class="Parameter" ID="L000004"
PartIDKeys="SheetName Side" Status="Available">
  <PageCondition RestrictedContentObjects="1 -1">
    <!--
      This example assumes that the pages of a sequence of documents of the
      RunList are to be treated as an aggregate page pool, and the pages are
      to be saddle stitch imposed onto a continuous sequence of sheets. Some
      documents of the sequence represent a start of a new chapter where their
      DocTag is set to the value 'Chapter'. These chapter starts force the
      first page of each chapter to be placed on the right side finished page.
    -->
    <Part DocRunIndex="0" DocTags="Chapter"/>
  </PageCondition>
</Layout SheetName="Mysheet">
  <Layout Side="Front">
    <ContentObject CTM="1 0 0 1 0 0" Ord="-1"/>
    <!-- Outside left -->
    <ContentObject CTM="1 0 0 1 595 0" Ord="0"/>
    <!-- outside right -->
  </Layout>
  <Layout Side="Back">
    <ContentObject CTM="1 0 0 1 0 0" Ord="1"/>
    <!-- inside left-->
    <ContentObject CTM="1 0 0 1 595 0" Ord="-2"/>
    <!-- inside right-->
  </Layout>
</Layout>
</Layout>
```

8.84.13 PlacedObject

The marks that are to be placed on the designated surface of a **Layout** come in two varieties: **ContentObject** or **MarkObject** elements. All inherit characteristics from the **AbstractPlacedObject** which is described below.

8.84.13.1 AbstractPlacedObject

Table 8.153: Abstract PlacedObject Element (Sheet 1 of 3)

NAME	DATA TYPE	DESCRIPTION
<i>Anchor</i> ? New in JDF 1.4	enumeration	Specifies the anchor point of the PlacedObject that SHALL remain in place on the surface when the value of @TrimSize changes. @Anchor is specified in the coordinate system of the PlacedObject prior to application of @CTM . Note: The @Anchor attribute is metadata used to identify (to an imposition generation utility) a fixed anchor point reference to an abstract content page. This may occur when a Layout resource is used as a template for that utility. @Anchor SHALL have no effect on processing when a Layout resource is input to the Imposition process. Allowed value is from: ▶ Anchor.
<i>AssemblyIDs</i> ? New in JDF 1.5	NMTOKENS	Identification of the Assembly elements if Stripping describes an imposition scheme for multiple Assembly elements. @AssemblyIDs MAY contain multiple NMTOKENS, when the Assembly resource specifies an intermediate product that contains multiple final assemblies BinderySignature .
<i>ClipBox</i> ?	rectangle	Clipping rectangle in terms of the coordinates of the @SurfaceContentsBox . @ClipBox SHALL NOT be present if PlacedObject/@ClipBoxFormat is supplied.
<i>ClipBoxFormat</i> ? New in JDF 1.4	string	A formatting string used with @ClipBoxTemplate to algorithmically construct @ClipBox . @ClipBoxFormat SHALL ONLY be present if PlacedObject/@ClipBox is not supplied and Layout/@Automated="true" . Allowed values are from: ▶ Appendix H String Generation.

Table 8.153: Abstract PlacedObject Element (Sheet 2 of 3)

NAME	DATA TYPE	DESCRIPTION
<i>ClipBoxTemplate</i> ? New in JDF 1.4	string	A list of values used with <i>@ClipBoxFormat</i> to algorithmically construct <i>@ClipBox</i> . <i>@ClipBoxTemplate</i> SHALL ONLY be present if <i>PlacedObject</i> / <i>@ClipBox</i> is not supplied and <i>Layout</i> / <i>@Automated</i> ="true". Allowed values are from: ▶ Appendix H String Generation.
<i>ClipPath</i> ? New in JDF 1.3	PDFPath	Clip path for the <i>PlacedObject</i> in the coordinates of the <i>@SurfaceContentsBox</i> (lower left of <i>@SurfaceContentsBox</i> is used as reference zero point, same as for <i>@ClipBox</i>). The actual clip region is the intersection of <i>@ClipBox</i> and <i>@ClipPath</i> , or the intersection of <i>@ClipBox</i> and <i>@SourceClipPath</i> . In both cases two regions are applied sequentially and the resulting clip region is smaller than either of those regions. <i>@ClipPath</i> and <i>@SourceClipPath</i> SHALL NOT be specified in the same <i>PlacedObject</i> . <i>@ClipPath</i> SHOULD be specified when both <i>@ClipPath</i> and <i>@SourceClipPath</i> are known because <i>@ClipPath</i> provides a more stable coordinate system (not sensitive to shifts caused by editing the page).
<i>CompensationCTMFormat</i> ? New in JDF 1.4	string	A formatting string used with <i>@CompensationCTMTemplate</i> to algorithmically construct a compensation CTM that SHALL be multiplied with to calculate the compensated CTM for an occurrence of this <i>PlacedObject</i> . <i>@CompensationCTMFormat</i> SHALL NOT be present unless <i>Layout</i> / <i>@Automated</i> ="true". Allowed values are from: ▶ Appendix H String Generation.
<i>CompensationCTMTemplate</i> ? New in JDF 1.4	string	A list of values used with <i>@CompensationCTMFormat</i> to algorithmically construct a compensation CTM that SHALL be multiplied with to calculate the compensated CTM for an occurrence of this <i>PlacedObject</i> . <i>@CompensationCTMTemplate</i> SHALL NOT be present unless <i>Layout</i> / <i>@Automated</i> ="true". Allowed values are from: ▶ Appendix H String Generation.
<i>CTM</i>	matrix	The coordinate transformation matrix (CTM — a Postscript term) of the object in the <i>@SurfaceContentsBox</i> . For details, see ▶ Figure 2-8: Equation for surface coordinate system transformations. The origin of the source coordinate system is the lower left (expressed in the source coordinate system) of the object and the origin of the destination coordinate system is lower left of the <i>@SurfaceContentsBox</i> . For details, see ▶ Section 2.6.1.1 Source Coordinate Systems. Note: <i>@CTM</i> SHALL be recalculated if the object is replaced afterwards with a new object with different dimensions.
<i>HalfTonePhaseOrigin</i> = "0 0"	XYPair	Location of the origin for screening of this <i>ContentObject</i> . Specified in the coordinate system of <i>@SurfaceContentsBox</i> .
<i>LayerID</i> ? New in JDF 1.1	integer	If a <i>Layout</i> supports layering (e.g., for versioning), <i>@LayerID</i> specifies the index of the <i>Layout</i> / <i>LayerList</i> / <i>LayerDetails</i> element in <i>Layout</i> / <i>LayerList</i> that a <i>ContentObject</i> belongs to (e.g., the language layer version). The details of the layers are specified in the <i>Layout</i> / <i>LayerList</i> / <i>LayerDetails</i> element.
<i>LogicalStackOrd</i> ? New in JDF 1.4	integer	0-based ▶ Logical Stack identifier that this <i>PlacedObject</i> belongs to. <i>@LogicalStackOrd</i> SHALL match the <i>@LogicalStackOrd</i> of an entry in <i>Layout</i> / <i>LogicalStackParams</i> / <i>Stack</i> .
<i>OrdID</i> ? New in JDF 1.1	integer	If a <i>Layout</i> supports layering (e.g., for versioning), elements that belong to the same final page SHOULD have a matching <i>@OrdID</i> .

Table 8.153: Abstract PlacedObject Element (Sheet 3 of 3)

NAME	DATA TYPE	DESCRIPTION
<i>SourceClipPath</i> ? Modified in JDF 1.3	PDFPath	Clip path for the PlacedObject in the source coordinate system. @ <i>SourceClipPath</i> is applied to the referenced source object in addition to any clipping that is internal to the object. Internal transformation of the source object (Rotation key in PDF, Orientation Tag in TIFF etc.) SHALL be applied prior to applying @ <i>SourceClipPath</i> . @ <i>ClipPath</i> and @ <i>SourceClipPath</i> SHALL NOT be specified in the same PlacedObject . See @ <i>ClipPath</i> for more details. See ▶ Section 2.6.1.1 Source Coordinate Systems for definitions of source coordinate systems.
<i>TrimClipPath</i> ? New in JDF 1.4	PDFPath	The die cutting path for the PlacedObject in the coordinates of the @ <i>SurfaceContentsBox</i> (lower left of @ <i>SurfaceContentsBox</i> is used as reference zero point, same as for @ <i>ClipBox</i>). That path can be used for proofing purpose. Note: The @ <i>TrimClipPath</i> attribute may be used by an imposition generation utility when a Layout resource is used as a template for that utility. This attribute has no effect on processing when a Layout resource is input to the Imposition process.
<i>TrimCTM</i> ? New in JDF 1.1	matrix	The transformation matrix of the trim box to be applied to the object's referenced content in the coordinate system of @ <i>SurfaceContentsBox</i> . Note that imposition programs that execute the Layout SHALL recalculate the @ <i>CTM</i> in case the referenced content is replaced with new referenced content having different dimensions, otherwise the position of the content inside the trim box will shift. This recalculation is based on @ <i>Anchor</i> , @ <i>TrimCTM</i> , @ <i>TrimSize</i> and trim box. Note: The @ <i>TrimCTM</i> attribute may be used by an imposition generation utility when a Layout resource is used as a template for that utility. @ <i>TrimCTM</i> SHALL have no effect on processing when a Layout resource is input to the Imposition process.
<i>TrimSize</i> ? New in JDF 1.2 Modified in JDF 1.4	XYPair	The size of the object's trim box as viewed in the object source coordinates (@ <i>TrimCTM</i> scaling and rotation NOT applied). Modified in JDF 1.4 @ <i>TrimSize</i> is needed when replacing the object by a new object with a different dimension. When a Layout resource is input to the Imposition process, @ <i>TrimSize</i> specifies the bounding box to be used for text layout when processing a MarkObject/DeviceMark or for scaling and rotation when processing PlacedObject/FitPolicy . Note: Recalculation of PlacedObject/@CTM is only necessary when the Stripping process or application needs to replace some pages from the provided RunList (using the Layout as a kind of imposition "template"). To ensure correct placement of a new page in the Layout , PlacedObject/@CTM recalculations SHOULD always be done according to PlacedObject/@TrimCTM and PlacedObject/@TrimSize . Together, these two attributes represent the trimming information of the imposition software page, which is not always the same as the original RunList page trimming information (= LayoutElement/@SourceTrimBox when real trim box of the object is known). Usage of both PlacedObject elements @ <i>TrimCTM</i> and @ <i>TrimSize</i> attributes will allow page replacements on any type of imposition Layout .
<i>Type</i> ? Deprecated in JDF 1.1	enumeration	Describes the kind of PlacedObject . Allowed values are: Content Mark
<i>FitPolicy</i> ? New in JDF 1.4	element	SHALL NOT be present when Layout/@Automated="false" . Specifies automated fit policy for the page cell described by the PlacedObject . When present, PlacedObject/@TrimSize SHALL also be present in the PlacedObject , and represents the cell size for this PlacedObject .

8.84.14 SheetCondition

New in JDF 1.4

Table 8.154: SheetCondition Element

NAME	DATA TYPE	DESCRIPTION
Condition ?	enumerations	<p>When present, defines an optional sheet by specifying each condition (equivalent to a logical or) under which the optional sheet is produced.</p> <p>Note: Terms below can be found in ▶ Table 6.48 Glossary for Automated Imposition.</p> <p>Values include:</p> <p>Begin – At the beginning of imposition processing (all sets in case of multiple Recipient Sets).</p> <p>End – At the end of imposition processing.</p> <p>BeginSet – At the beginning of processing of an individual Recipient Set.</p> <p>EndSet – At the end of processing of an individual Recipient Sets.</p> <p>PagePoolBegin – At the beginning of processing of a Page Pool.</p> <p>PagePoolEnd – At the the end of processing of a Page Pool.</p> <p>PagePoolListBegin – At the beginning of processing of a Page Pool List.</p> <p>PagePoolListEnd – At the end of processing of a Page Pool List.</p> <p>LogicalStackBegin – adds a Logical Sheet to the beginning of each Logical Stack generated as part of an Imposed Sheet Set.</p> <p>LogicalStackEnd – adds a Logical Sheet to the end of each Logical Stack generated as part of an Imposed Sheet Set.</p> <p>LogicalStackSetBegin – At the beginning of generation of a set of Logical Stacks.</p> <p>Note: @LogicalStackOrd SHALL be used to indicate the Logical Stack on which the conditional sheet is placed.</p> <p>LogicalStackSetEnd – At the end of generation of a set of Logical Stacks.</p> <p>Note: @LogicalStackOrd SHALL be used to indicate the Logical Stack on which the conditional sheet is placed.</p> <p>ImposedSheetSetBegin – At the beginning of generation of an Imposed Sheet Set.</p> <p>Note: This generates a separator sheet not counted as part of the Imposed Sheet Set. Any MarkObject elements specifying @LogicalStackOrd are ignored.</p> <p>ImposedSheetSetEnd – At the end of generation of an ▶ Imposed Sheet Set.</p> <p>Note: This generates a separator sheet not counted as part of the Imposed Sheet Set. Any MarkObject elements specifying @LogicalStackOrd are ignored.</p>
RunList ?	refelement	<p>Supplies content for any ContentObject elements specified within the optional sheet definition. All ContentObject elements in the optional sheet definition SHALL reference content supplied by this RunList.</p>

8.84.15 Signature

Deprecated in JDF 1.3

All attributes that were defined in [Signature](#) have been moved into [Layout](#).

8.84.16 Stack

New in JDF 1.4

Table 8.155: Stack Element (Sheet 1 of 2)

NAME	DATA TYPE	DESCRIPTION
LogicalStackOrd	integer	<p>0-based ▶ Logical Stack identifier that specifies which ▶ Logical Stack is controlled by this Stack element. The value of Stack/@LogicalStackOrd SHALL correspond to a PlacedObject/@LogicalStackOrd value.</p>

Table 8.155: Stack Element (Sheet 2 of 2)

NAME	DATA TYPE	DESCRIPTION
<i>LogicalStackSequence</i> e="SheetIndex"	enumeration	Specifies how Logical Sheets SHALL be placed onto the Logical Stack. Allowed values are: <i>SheetIndex</i> – Logical Sheets are placed in the order of ascending @ <i>SheetIndex</i> . <i>DescendingSheetIndex</i> – Logical Sheets are placed in the order of descending @ <i>SheetIndex</i> .

8.84.17 More about Layout

8.84.17.1 Migrating from a Pre-JDF 1.3 Layout to a Partitioned Layout

New in JDF 1.3

The **Layout** resource was significantly modified in **JDF 1.3**. This section describes how a pre-**JDF 1.3** **Layout** can be transformed into a **JDF 1.3** **Layout** and what restrictions MAY be applied to a **JDF 1.3** **Layout** so that it can be easily transformed into a pre-**JDF 1.3** **Layout** or a PJTF layout.

Note: This section is not applicable when **Layout/@Automated="true"** for any partitions.

8.84.17.1.1 Partition Key restrictions:

If "SignatureName", "SheetName" or "Side" are specified in @*PartIDKeys*, the order SHALL be specified as "SignatureName SheetName Side".

Only a **Layout** with exactly @*PartIDKeys*="SignatureName SheetName Side" can be translated into a **JDF 1.2** **Layout** or a PJTF. Thus, it is highly RECOMMENDED to use exactly this partitioning of the **Layout** in **JDF 1.3** whenever possible. Any other partitioning will make consumption by existing products very unlikely.

8.84.17.1.2 Position of PlacedObject Elements in Layout

In order to avoid ambiguities in the layering order, **MarkObject** elements and **ContentObject** elements SHALL only be specified in the leaves of partitioned resources.

Example 8.21: Invalid MarkObject

The following INVALID example is correct according to Section 3.10.5.1 Subelements in Partitioned Resources. If standard partitioning inheritance were permitted for **MarkObject** elements and **ContentObject** elements it would be unclear whether the **ContentObject** in Sheet01 is layered over or under <MarkObject Ord="1">:

```
<Layout Class="Parameter" ID="L3"
  PartIDKeys="SignatureName SheetName Side" Status="Available">
  <!-- INVALID, this PlacedObject is not in a leaf partition and not used -->
  <!-- since it is overwritten by <MarkObject Ord="1"> -->
  <MarkObject CTM="0.0 1.0 -1.0 0.0 176.69 23.62" Ord="0">
    <RegisterMark Center="0.0 0.0" MarkType="Cross" MarkUsage="PaperPath"/>
  </MarkObject>
  <Layout SignatureName="Sig00">
    <!-- INVALID, this PlacedObject is not in a leaf partition -->
    <MarkObject CTM="0.0 1.0 -1.0 0.0 176.69 23.62" Ord="1">
      <RegisterMark Center="0.0 0.0" MarkType="Cross" MarkUsage="PaperPath"/>
    </MarkObject>
  </Layout>
  <Layout SheetName="Sheet00">
    <Layout Side="Front">
      <MarkObject CTM="0.0 1.0 -1.0 0.0 176.69 23.62" Ord="2">
        <RegisterMark Center="0.0 0.0" MarkType="Arc" MarkUsage="PaperPath"/>
      </MarkObject>
      <ContentObject CTM="0.0 1.0 -1.0 0.0 176.69 23.62" Ord="0"/>
    </Layout>
  </Layout>
  <Layout SheetName="Sheet01">
    <Layout Side="Front">
      <!-- Not clear whether this is layered over or under <MarkObject Ord="0"> -->
      <ContentObject CTM="0.0 1.0 -1.0 0.0 176.69 23.62" Ord="0"/>
    </Layout>
  </Layout>
</Layout>
```

Example 8.22: MarkObject

This VALID example is contains the same *PlacedObject* elements as the previous example but they are correctly specified in the leaves of the partitioned *Layout*.

```
<Layout Class="Parameter" ID="L3"
  PartIDKeys="SignatureName SheetName Side" Status="Available">
  <Layout SignatureName="Sig00">
    <Layout SheetName="Sheet00">
      <Layout Side="Front">
        <MarkObject CTM="0.0 1.0 -1.0 0.0 176.69 23.62" Ord="2">
          <RegisterMark Center="0.0 0.0" MarkType="Arc" MarkUsage="PaperPath"/>
        </MarkObject>
        <ContentObject CTM="0.0 1.0 -1.0 0.0 176.69 23.62" Ord="0"/>
      </Layout>
    </Layout>
  </Layout>
  <Layout SheetName="Sheet01">
    <Layout Side="Front">
      <MarkObject CTM="0.0 1.0 -1.0 0.0 176.69 23.62" Ord="1">
        <RegisterMark Center="0.0 0.0" MarkType="Cross" MarkUsage="PaperPath"/>
      </MarkObject>
      <ContentObject CTM="0.0 1.0 -1.0 0.0 176.69 23.62" Ord="0"/>
    </Layout>
  </Layout>
</Layout>
```

8.84.17.2 CTM Definitions

New in JDF 1.2

The following are explanations of the terms used in this section and beyond:

- **Dimensions of object** – The width and height of either the box defined to include all drawings for this file format, or the artificial box that includes these drawings for file formats that have no clearly defined box for this.
- **Trim box of the signature page** – A rectangle that indicates where the trim box of object SHALL be positioned. This is the equivalent to the area the user is intended to see in the final product. Positioning the trim box of the object inside the trim box of the signature page is implementation-specific (usually it is centered).
- **Trim box of the object** – A rectangle that is PDL-specific that indicates the area of the object that indicates the intended trimming area.

8.84.17.3 Finding the Trim Box of an Object

LayoutElement/@SourceTrimBox always takes precedence over boxes defined inside the PDL. Make sure that *LayoutElement/@SourceTrimBox* is updated after replacing elements. The following is a list of names used for the real trim box in various file formats:

- PostScript (PS) – **PageSize**
- Encapsulated PostScript (EPS) – **CropBox**
- Portable Document Format (PDF) – **TrimBox**
- Raster files – entire area

If this information is not available, alternative sources for trim box information can include:

- EPS – **HiResBoundingBox** then **BoundingBox**
- PDF – **CropBox** then **MediaBox**

Note: These boxes might not be correct in all cases.

8.84.17.4 Using Ord to Reference Elements in RunList Resources

New in JDF 1.1A

The *@Ord* attribute in *ContentObject* or *MarkObject* elements represents a reference to a *logical* element in a *RunList*. The index is incremented for every page of the *RunList* with *@IsPage="true"*. The reference is not changed by repartitioning the *RunList*. The content and marks *RunList* are referenced independently. The following examples illustrate the usage of *@Ord*.

Example 8.23: RunList: Simple Multi-File Unseparated RunList

This example specifies all pages contained in File1.pdf and File2.pdf. File 1 has 6 pages, file 2 has an unknown number of pages.

```
<RunList Class="Parameter" ID="L3" PartIDKeys="Run" Status="Available">
  <RunList NPage="6" Pages="0 ~ 5" Run="1">
    <LayoutElement>
      <FileSpec URL="File:///File1.pdf"/>
    </LayoutElement>
  </RunList>
  <RunList Pages="0 ~ -1" Run="2">
    <LayoutElement>
      <FileSpec URL="File:///File2.pdf"/>
    </LayoutElement>
  </RunList>
</RunList>
```

Table 8.156: Example (1) of Ord Attribute in PlacedObject Elements

ORD	FILE	PAGE	ORD	FILE	PAGE
0	File1	0	1	File1	1
2	File1	2	3	File1	3
4	File1	4	5	File1	5
6	File2	0	7	File2	1
8	File2	2	(n)	File2	(n - 6)

Example 8.24: RunList: Simple Multi-File Separated RunList

This example specifies two pages contained in Presep.pdf and following that, pages 1, 3 and 5 of each preprepared file.

```
<RunList Class="Parameter" ID="Link0003" PartIDKeys="Run Separation" Status="Available">
  <RunList NPage="2" Run="1" SkipPage="3">
    <LayoutElement>
      <FileSpec URL="File:///Presep.pdf"/>
    </LayoutElement>
    <RunList FirstPage="0" IsPage="false" Separation="Cyan"/>
    <RunList FirstPage="1" IsPage="false" Separation="Magenta"/>
    <RunList FirstPage="2" IsPage="false" Separation="Yellow"/>
    <RunList FirstPage="3" IsPage="false" Separation="Black"/>
  </RunList>
  <RunList IsPage="true" Pages="1 3 5" Run="2">
    <RunList IsPage="false" Separation="Cyan">
      <LayoutElement>
        <FileSpec URL="File:///Cyan2.pdf"/>
      </LayoutElement>
    </RunList>
    <RunList IsPage="false" Separation="Magenta">
      <LayoutElement>
        <FileSpec URL="File:///Magenta2.pdf"/>
      </LayoutElement>
    </RunList>
    <RunList IsPage="false" Separation="Yellow">
      <LayoutElement>
        <FileSpec URL="File:///Yellow2.pdf"/>
      </LayoutElement>
    </RunList>
    <RunList IsPage="false" Separation="Black">
      <LayoutElement>
        <FileSpec URL="File:///Black2.pdf"/>
      </LayoutElement>
    </RunList>
  </RunList>
</RunList>
```

Table 8.157: Example (2) of Ord Attribute in PlacedObject Elements

ORD	FILE	PAGE	SEPARATION	ORD	FILE	PAGE	SEPARATION
0	PreSep	0	Cyan	0	Presep	1	Magenta
0	PreSep	2	Yellow	0	Presep	3	Black
1	PreSep	4	Cyan	1	Presep	5	Magenta
1	PreSep	6	Yellow	1	Presep	7	Black
2	Cyan2	1	Cyan	2	Magenta2	1	Magenta
2	Yellow2	1	Yellow	2	Black2	1	Black
3	Cyan2	3	Cyan	3	Magenta2	3	Magenta
3	Yellow2	3	Yellow	3	Black2	3	Black
4	Cyan2	5	Cyan	4	Magenta2	5	Magenta
4	Yellow2	5	Yellow	4	Black2	5	Black

8.84.17.5 Using Expressions in the OrdExpression Attribute

Expressions can use the operators +, -, *, /, % and parentheses, operating on integers and two variables: *s* for signature number (starting at 0) and *n* for number of pages to be imposed in one document. Signature number denotes the number of times that a complete set of placed objects has been filled with content from the run list. The operators have the same meaning as in the C programming language. Expressions are evaluated with normal “C” operator precedence. Multiplication SHALL be expressed by explicitly including the * operator (i.e., use “2*s”, not “2 s”). Remainders are discarded.

Example 8.25: OrdExpression

Saddle stitched booklet for variable page length documents.

The following describes the ord expressions for a booklet with varying page lengths. The example page assignments are for a book of 13–16 pages.

Table 8.158: OrdExpression for Varying Page Length Booklet

ORDEXPRESSION	ITERATION 1	ITERATION 2	ITERATION 3	ITERATION 4
$2*s$	0	2	4	6
$4*((n+3)/4)-(s*2)-1$	15	13	11	9
$2*s+1$	1	3	5	7
$4*((n+3)/4)-(s*2)-2$	14	12	10	8

Example 8.26: DocOrd Usage

Two-sided business cards four per sheet.

The following describes the Ord and DocOrd usage for a 4-up step + repeat business card.

Table 8.159: DocOrd Usage

MAXDOCORD	SIDE	ORD	DOCORD
4	Front	0	0
4	Front	0	1
4	Front	0	2
4	Front	0	3
4	Back	1	0
4	Back	1	1
4	Back	1	2
4	Back	1	3

8.85 LayoutElement

LayoutElement is needed for **LayoutElementProduction**. It describes some text, an image, one or more pages or anything else that is used in the production of the layout of a product.

Resource Properties

Resource Class: Parameter

Resource referenced by: [LayoutElement/Dependencies](#), [LayoutElementProductionParams/LayoutElementPart](#), [RunList](#)

Example Partition: "PageNumber"

Input of Processes: [LayoutElementProduction](#), [ShapeDefProduction](#)

Output of Processes: [LayoutElementProduction](#)

Table 8.160: LayoutElement Resource (Sheet 1 of 3)

NAME	DATA TYPE	DESCRIPTION
ClipPath ? Modified in JDF 1.2	PDFPath	Path that describes the outline of the LayoutElement in the coordinate space of the LayoutElement of <code>@ElementType="Page"</code> that results from the LayoutElementProduction process. The default case is that there is no clip path. <code>@ClipPath</code> , <code>@SourceClipBox</code> , PlacedObject/@SourceClipPath and PlacedObject/@ClipBox if supplied, SHALL be concatenated.
ContentDataRefs ? New in JDF 1.4	IDREFS	IDs of ContentData elements in the referenced ContentList . ContentData elements provide metadata related to the product to be published. <code>@ContentDataRefs</code> SHALL NOT be specified if no ContentList is specified.

Table 8.160: LayoutElement Resource (Sheet 2 of 3)

NAME	DATA TYPE	DESCRIPTION
<i>ElementType</i> ? Modified in JDF 1.3	enumeration	Describes the content type for this <i>LayoutElement</i> . Allowed values are from: ▶ <i>ElementType</i> .
<i>HasBleeds</i> ? Modified in JDF 1.2	boolean	If "true", the file has bleeds. If not specified, the set of values of <i>PageList/PageData/@HasBleeds</i> selected by <i>@PageListIndex</i> is applied.
<i>IgnorePDLCopies="false"</i> New in JDF 1.1	boolean	If "true", any PDL defined copy count SHALL be ignored.
<i>IgnorePDLImposition="true"</i> New in JDF 1.1	boolean	If "true", any PDL defined imposition definition SHALL be ignored. Examples are PDF with embedded PJTF or PPML with a PRINT_LAYOUT. If <i>@IgnorePDLImposition="false"</i> and JDF also defines imposition, the imposed sheets of the PDL are treated as pages in the context of JDF imposition. The front and back surfaces of the PDL and JDF imposition SHOULD be matched. Note that it is strongly discouraged to specify imposition both in the PDL and JDF , and that this might result in undesired behavior.
<i>IsBlank</i> ? New in JDF 1.2	boolean	If "true", the <i>LayoutElement</i> has no content marks and is blank. If not specified, the set of values of <i>PageList/PageData/@IsBlank</i> selected by <i>@PageListIndex</i> is applied. Note that in JDF 1.2 the description erroneously stated that <i>@IsBlank="false"</i> specifies a blank page.
<i>IsPrintable</i> ? Modified in JDF 1.2	boolean	If "true", the file is a PDL file and can be printed. Possible file types include PCL, PDF or PostScript files. Application files such as MS Word have <i>@IsPrintable="false"</i> . If not specified, the set of values of <i>PageList/PageData/@IsPrintable</i> selected by <i>@PageListIndex</i> is applied.
<i>IsTrapped</i> ? Modified in JDF 1.2	boolean	If "true", the file has been trapped. If not specified, the set of values of <i>PageList/PageData/@IsTrapped</i> selected by <i>@PageListIndex</i> is applied.
<i>PageListIndex</i> ? New in JDF 1.2	IntegerRangeList	List of the indices of the <i>PageData</i> elements of the <i>PageList</i> specified in this <i>LayoutElement</i> . Note that this list MAY be overridden by the <i>RunList</i> that contains this <i>LayoutElement</i> and refers to a subset of this <i>LayoutElement</i> . <i>PageList</i> SHALL be specified if <i>@PageListIndex</i> is specified.
<i>SetLevel</i> ? New in JDF 1.4	XPath	Specifies the mapping for the structure of a document of type MultiSet to the structure processed by the PDL processor. If specified, the XPath expression selects a node set from the structured PDL's hierarchy. Each node of that node set is processed by the PDL processor as a JDF set. If not specified, the nodes that are processed as a set by the PDL processor SHALL be defined by the PDL. If the PDL does not define which nodes represent sets, then which nodes represent sets is undefined. Note: An example of a PDL that can define which nodes represent sets is ISO 16612-2 (PDF/VT), where the <i>DPartRoot/@RecordLevel</i> can provide that mapping.
<i>SourceBleedBox</i> ? Modified in JDF 1.2	rectangle	A rectangle that describes the bleed area of the element to be included. This rectangle is expressed in the source coordinate system of the object. If not specified, the set of values of <i>PageList/PageData/@SourceBleedBox</i> selected by <i>@PageListIndex</i> is applied.
<i>SourceClipBox</i> ? Modified in JDF 1.2	rectangle	A rectangle that defines the region of the element to be included. This rectangle is expressed in the source coordinate system of the object. If not specified, the set of values of <i>PageList/PageData/@SourceClipBox</i> selected by <i>@PageListIndex</i> is applied.
<i>SourceMediaBox</i> ? New in JDF 1.4	rectangle	A rectangle that defines the intended media size of the element. This rectangle is expressed in the source coordinate system of the object.
<i>SourceTrimBox</i> ? Modified in JDF 1.2	rectangle	A rectangle that describes the intended trimmed size of the element to be included. This rectangle is expressed in the source coordinate system of the object. If not specified, the set of values of <i>PageList/PageData/@SourceTrimBox</i> selected by <i>@PageListIndex</i> is applied.

Table 8.160: LayoutElement Resource (Sheet 3 of 3)

NAME	DATA TYPE	DESCRIPTION
<i>Template</i> ? Modified in JDF 1.2	boolean	@ <i>Template</i> is "false" when this layout element is self-contained. This attribute is "true" if the <i>LayoutElement</i> represents a template that SHALL be completed with information from a database. If not specified, the value of <i>PageList/PageData/@Template</i> is applied.
<i>ColorPool</i> ? New in JDF 1.2	refelement	Definition of the color details.
<i>ContentList</i> ? New in JDF 1.4	refelement	<i>ContentList</i> with additional metadata. Constraint: At most one of <i>ContentList</i> and <i>PageList</i> SHALL be specified.
<i>Dependencies</i> ? New in JDF 1.2	element	List of dependent references (e.g., fonts, external images, etc.).
<i>ElementColorParams</i> ? New in JDF 1.2	refelement	Color details of the <i>LayoutElement</i> . If not specified, the value of <i>PageList/PageData/ElementColorParams</i> is applied.
<i>FileSpec</i> ? Modified in JDF 1.2	refelement	URL plus metadata about the physical characteristics of a file representing the <i>LayoutElement</i> . If not present, then only metadata is known but not the content file.
<i>ImageCompressionParams</i> ? New in JDF 1.2	refelement	Specification of the image compression properties. If not specified, the value of <i>PageList/PageData/ImageCompressionParams</i> is applied.
<i>PageList</i> ? New in JDF 1.2	refelement	Specification of page metadata for pages described by this <i>LayoutElement</i> . Constraint: At most one of <i>ContentList</i> and <i>PageList</i> SHALL be specified.
<i>ScreeningParams</i> ? New in JDF 1.2	refelement	Specification of the screening properties. If not specified, the value of <i>PageList/PageData/ScreeningParams</i> is applied.
<i>SeparationSpec</i> * Modified in JDF 1.2	element	List of used separation names. If not specified, the value of <i>PageList/PageData/SeparationSpec</i> applies.

8.85.1 Dependencies

New in JDF 1.2

This element provides a container for dependent references of the *LayoutElement*.

Table 8.161: Dependencies Element

NAME	DATA TYPE	DESCRIPTION
<i>LayoutElement</i> *	refelement	Description of dependent elements (e.g., fonts, images, etc.).

8.86 LayoutElementProductionParams

New in JDF 1.3

LayoutElementProductionParams is needed for *LayoutElementProduction*. This resource contains detailed information about the type of *LayoutElement* to be produced. Before **JDF 1.4**, it only contains information for automated production of barcodes. Starting with **JDF 1.4**, the description of positioning of the graphics is added.

Resource Properties

Resource Class: Parameter

Intent Pairing: *VariableIntent*

Input of Processes: **LayoutElementProduction**

Table 8.162: LayoutElementProductionParams Resource

NAME	DATA TYPE	DESCRIPTION
ActionPool ? New in JDF 1.4	element	A pool of Action elements that describe the restrictions that are applied to the created output
FileSpec (DataList) ? New in JDF 1.5	refelement	References a data list containing record information for variable data production. The format of the referenced data is implementation specific.
LayoutElementPart * *	element	Description of the specific parameters for generating a LayoutElement .
ShapeDef ? New in JDF 1.4	refelement	A resource describing the shape of the LayoutElement to be produced.
TestPool ? New in JDF 1.4	element	Container for zero or more test elements that are referenced from Action elements in the ActionPool . TestPool SHALL be supplied if ActionPool is present.

Example 8.27: LayoutElementProductionParams: Page Shape

The following example requests four pages with a trim size of A4 and a 5mm bleed.

Note: 14.17pts = 5mm.

```
<!-- Page Shape Sample
    Date: Aug 2, 2007 Version: 2
    A page with a certain size -->
<JDF DescriptiveName="Page sample for shape" ID="n001" JobPartID="ID34"
    Status="Waiting" Type="LayoutElementProduction" Version="1.6" xmlns="http://www.CIP4.org/JDF-
FSchema_1_1">
  <ResourcePool>
    <LayoutElementProductionParams Class="Parameter" ID="LEPPParams" Status="Available"/>
    <LayoutElement Class="Parameter" ID="LayElOut"
      SourceMediaBox="0 0 595.27 822.05"
      SourceTrimBox="28.34 28.34 566.93 793.71" Status="Unavailable"/>
  </ResourcePool>
  <ResourceLinkPool>
    <LayoutElementProductionParamsLink Usage="Input" rRef="LEPPParams"/>
    <LayoutElementLink Usage="Output" rRef="LayElOut"/>
  </ResourceLinkPool>
  <AuditPool>
    <Created Author="XYZ Corporation" TimeStamp="2006-01-09T09:00:00+01:00"/>
  </AuditPool>
</JDF>
```

Example 8.28: LayoutElementProductionParams: Label Shape

The following example requests a label shape with an explicit triangular cut path.

```
<!-- Shape Sample for a label with a cut line
      Date: Jan 9, 2005 Version: 1.00
      A page with a certain size -->
<JDF DescriptiveName="Page sample for shape" ID="n001" JobPartID="ID400"
      Status="Waiting" Type="LayoutElementProduction" Version="1.6" xmlns="http://www.CIP4.org/JD-
FSchema_1_1">
  <ResourcePool>
    <LayoutElementProductionParams Class="Parameter" ID="LEPParams" Status="Available">
      <ShapeDef>
        <Shape CutPath="..." DDESCutType="101" ShapeType="Path"/>
      </ShapeDef>
    </LayoutElementProductionParams>
    <LayoutElement Class="Parameter" ID="LayElOut"
      SourceMediaBox="0 0 595.27 822.05"
      SourceTrimBox="28.34 28.34 566.93 793.71" Status="Unavailable"/>
  </ResourcePool>
  <ResourceLinkPool>
    <LayoutElementProductionParamsLink Usage="Input" rRef="LEPParams"/>
    <LayoutElementLink Usage="Output" rRef="LayElOut"/>
  </ResourceLinkPool>
  <AuditPool>
    <Created Author="ABC-Corporation" TimeStamp="2006-01-09T09:00:00+01:00"/>
  </AuditPool>
</JDF>
```

Example 8.29: LayoutElementProductionParams: Box Shape

The following example requests a box that is described by an external CAD file.

```
<!-- Shape Sample for a box defined by a CAD file
      Date: Jan 9, 2005 Version: 1.00
      A page with a certain size -->
<JDF DescriptiveName="Page sample for shape" ID="n001" JobPartID="ID100"
      Status="Waiting" Type="LayoutElementProduction" Version="1.6" xmlns="http://www.CIP4.org/JD-
FSchema_1_1">
  <ResourcePool>
    <LayoutElementProductionParams Class="Parameter" ID="LEPParams" Status="Available">
      <ShapeDef>
        <FileSpec URL="file://myserver/myshare/olive.dd3"/>
      </ShapeDef>
    </LayoutElementProductionParams>
    <LayoutElement Class="Parameter" ID="LayElOut" Status="Unavailable"/>
  </ResourcePool>
  <ResourceLinkPool>
    <LayoutElementProductionParamsLink Usage="Input" rRef="LEPParams"/>
    <LayoutElementLink Usage="Output" rRef="LayElOut"/>
  </ResourceLinkPool>
  <AuditPool>
    <Created Author="ZYX Corporation" TimeStamp="2006-01-09T09:00:00+01:00"/>
  </AuditPool>
</JDF>
```

8.86.1 LayoutElementPart

LayoutElementPart is a generic placeholder for specifying details of **LayoutElementProduction**. Currently only details of barcode production have been fleshed out but additional processes are anticipated. Note that the ordering of **LayoutElementPart** elements might become significant in future versions.

Table 8.163: LayoutElementPart Element (Sheet 1 of 2)

NAME	DATA TYPE	DESCRIPTION
ID ? New in JDF 1.4	ID	ID of the LayoutElementPart .

Table 8.163: *LayoutElementPart* Element (Sheet 2 of 2)

NAME	DATA TYPE	DESCRIPTION
Comment ?	element	Human readable instructions on how this LayoutElementPart should be processed.
BarcodeProductionParams ?	element	Description of the specific parameters for barcode production.
ColorCorrectionParams ? New in JDF 1.5	refelement	Parameters of ColorCorrection that have been applied to this LayoutElementPart .
ImageCompressionParams ? New in JDF 1.5	refelement	Image compression that has been applied to this LayoutElementPart .
ImageEnhancementParams ? New in JDF 1.5	refelement	Image enhancement operations that have been applied to this LayoutElementPart
LayoutElement ? New in JDF 1.4	refelement	Specification of an existing LayoutElement that is used to initially populate this LayoutElementPart . Any LayoutElement resources that are specified here SHALL also be specified as input resources to the LayoutElementProduction process.
PositionObj ? New in JDF 1.4	element	Definition of the size and position of this LayoutElementPart

8.86.2 BarcodeProductionParams

[BarcodeProductionParams](#) describes of the specific parameters for barcode production.

Table 8.164: *BarcodeProductionParams* Element

NAME	DATA TYPE	DESCRIPTION
BarcodeReproParams ?	element	Description of the formatting and reproduction parameters for barcode production.
IdentificationField	refelement	Description of the barcode metadata.

8.86.3 PositionObj

New in JDF 1.4

[PositionObj](#) describes the size and position of the [LayoutElementPart](#).

Table 8.165: *PositionObj* Element (Sheet 1 of 2)

NAME	DATA TYPE	DESCRIPTION
Anchor ?	enumeration	@Anchor specifies the origin (0,0) of the coordinate system in the unrotated LayoutElementPart . Allowed value is from: ▶ Anchor .
CTM ?	matrix	Specifies the transformation matrix of the origin of LayoutElementPart as specified by @Anchor . Not that this is not necessarily the actual CTM that will position a given LayoutElementPart . The actual CTM SHALL be recalculated based on the values of @Anchor and @Size .
PageRange ?	IntegerRangeList	Reader page index in the PageList .
PositionPolicy ?	enumeration	Specifies the level of freedom when applying the values specified in PositionObj . Allowed value is from: ▶ PositionPolicy .

Table 8.165: PositionObj Element (Sheet 2 of 2)

NAME	DATA TYPE	DESCRIPTION
<i>RelativeSize</i> ?	XYPair	Specifies the size of the unrotated and unscaled object, relative to the parent specified in <i>RefAnchor</i> .
<i>RotationPolicy</i> ?	enumeration	Specifies the level of freedom when applying the values specified in <i>PositionObj</i> . Allowed value is from: ▶ PositionPolicy.
<i>Size</i> ?	XYPair	Specifies the size of the unrotated and unscaled object, in points.
<i>SizePolicy</i> ?	enumeration	Specifies the level of freedom when applying the values specified in <i>PositionObj</i> . Allowed value is from: ▶ PositionPolicy.
<i>RefAnchor</i> ?	element	Reference to a <i>LayoutElementPart</i> that this <i>LayoutElementPart</i> is positioned relative to. If <i>RefAnchor</i> is not specified, <i>PositionObj</i> refers to the lower left of the first page specified in page range.

Example 8.30: LayoutElementProductionParams: PositionObj

```

<!--This is a "well placed" CTM defined mark
  The anchor defines the 0,0 point to be transformed
  The element to be placed is referenced by LayoutElement/FileSpec/URL
-->
<LayoutElementPart>
  <PositionObj Anchor="BottomLeft" CTM="1 0 0 1 0 0" PageRange="0" PositionPolicy="Exact">
    <RefAnchor Anchor="BottomLeft" AnchorType="Parent"/>
  </PositionObj>
  <LayoutElement Class="Parameter">
    <FileSpec Class="Parameter" MimeType="application/pdf" URL="bkg.pdf"/>
  </LayoutElement>
</LayoutElementPart>
<!--This is a "roughly placed" reservation in the middle of the page-->
<LayoutElementPart ID="1000006">
  <PositionObj Anchor="Center" PageRange="0" PositionPolicy="Free">
    <RefAnchor Anchor="Center" AnchorType="Parent"/>
  </PositionObj>
  <LayoutElement Class="Parameter" ElementType="Image">
    <Comment ID="c000007">
      Please add an image of a palm tree on a beach here!
    </Comment>
  </LayoutElement>
</LayoutElementPart>
<!--This is a "well placed" CTM defined mark. The anchor defines the
  0,0 point used as the RefAnchor for the element to be transformed -->
<LayoutElementPart>
  <PositionObj Anchor="BottomLeft" CTM="1 0 0 1 2 3" PageRange="0" PositionPolicy="Exact">
    <RefAnchor Anchor="BottomLeft" AnchorType="Parent"/>
  </PositionObj>
  <BarcodeProductionParams>
    <!--barcode details here-->
    <IdentificationField Encoding="Barcode" EncodingDetails="CODABAR"/>
  </BarcodeProductionParams>
</LayoutElementPart>
<!--This is a "roughly placed" container for marks
  The anchor at top left is defined in the !Unrotated! orientation.
  It is placed at the left (=0.0) bottom(=0.0) position of the page.
  The text flows bottom to top (=Rotate 90 = counterclockwise)
  do we need margins?
-->
<LayoutElementPart ID="1000009">
  <PositionObj Anchor="TopLeft" CTM="0 1 -1 0 0 0" PageRange="1" PositionPolicy="Free">
    <RefAnchor Anchor="BottomCenter" AnchorType="Parent"/>
  </PositionObj>
</LayoutElementPart>
<!--This is a barcode inside the previous container
  The anchor at bottom left is defined in the !Unrotated! orientation.
  It is placed at the left (=0.0) bottom(=0.0) position of the container.
-->
<LayoutElementPart ID="1000010">
  <PositionObj Anchor="BottomLeft" CTM="1 0 0 1 0 0">
    <RefAnchor Anchor="BottomLeft" AnchorType="Parent" rRef="1000009"/>
  </PositionObj>
  <BarcodeProductionParams>
    <!--barcode details here-->
    <IdentificationField Encoding="Barcode" EncodingDetails="CODABAR"/>
  </BarcodeProductionParams>
</LayoutElementPart>

```

Example 8.31: LayoutElementProductionParams: Preflight

```

<LayoutElementProductionParams Class="Parameter" ID="r000005" Status="Unavailable">
  <Comment ID="c000006" Name="Instruction">
    Add any human readable instructions here
  </Comment>
  <ActionPool>
    <Action DescriptiveName="set number of pages to 4" ID="A000007"
      Severity="Error" TestRef="T000008"/>
    <Action
      DescriptiveName="set number of separations to 6 on page 0 and 3"
      ID="A000009" Severity="Error" TestRef="T000010">
      <PreflightAction SetRef="T000011"/>
    </Action>
    <Action
      DescriptiveName="separation to black only on page 1 and 2"
      ID="A000012" Severity="Error" TestRef="T000013">
      <PreflightAction SetRef="T000014"/>
    </Action>
    <Action
      DescriptiveName="Warn when effective resolution<300 dpi"
      ID="A000018" Severity="Warning" TestRef="T000019"/>
  </ActionPool>
  <TestPool>
    <Test ID="T000008">
      <not>
        <IntegerEvaluation ValueList="4">
          <BasicPreflightTest Name="NumberOfPages"/>
        </IntegerEvaluation>
      </not>
    </Test>
    <Test ID="T000010">
      <not>
        <StringEvaluation>
          <BasicPreflightTest ListType="UniqueList" MaxOccurs="6"
            MinOccurs="6" Name="SeparationList"/>
        </StringEvaluation>
      </not>
    </Test>
    <Test ID="T000011">
      <IntegerEvaluation ValueList="0 3">
        <BasicPreflightTest Name="PageNumber"/>
      </IntegerEvaluation>
    </Test>
    <Test ID="T000013">
      <not>
        <StringEvaluation>
          <BasicPreflightTest Name="SeparationList"/>
          <Value Value="Black"/>
        </StringEvaluation>
      </not>
    </Test>
    <Test ID="T000014">
      <IntegerEvaluation ValueList="1 ~ 2">
        <BasicPreflightTest Name="PageNumber"/>
      </IntegerEvaluation>
    </Test>
    <Test ID="T000019">
      <XYPairEvaluation ValueList="0 0 ~ 300 300">
        <BasicPreflightTest Name="EffectiveResolution"/>
      </XYPairEvaluation>
    </Test>
  </TestPool>
</LayoutElementProductionParams>

```

8.87 LayoutPreparationParams

New in JDF 1.1

RESOURCES

LayoutPreparationParams provides the parameters of the **LayoutPreparation** process, which provides the details of how finished page contents will be imaged onto media. This resource has a provision for specifying either a multi-up grid of content page cells or an imposition layout of finished pages. The **LayoutPreparation** also provides means to specify creeping gutters for booklet imposition. In the case where attributes of **LayoutPreparationParams** used to explicitly control creep are specified, the **@MinGutter** and **@GutterPolicy** attributes of **FitPolicy**, which affect the adjustment of gutter widths, SHALL NOT be specified.

A multi-up grid of pages can be ‘step and repeated’ across, down, or through a stack of sheets in any axis order.

Note: For all resources, the coordinate system for all parameters is defined with respect to the process coordinate system as defined in ▶ Section 2.6.3 Coordinate Systems of Resources and Processes. The process coordinate system for **LayoutPreparation** is defined by the **Layout** resource coordinate system.

Resource Properties

Resource Class: Parameter
 Intent Pairing: **LayoutIntent**
 Example Partition: "DocIndex", "DocRunIndex", "RunIndex", "SetIndex", "SheetName"
 Input of Processes: **LayoutPreparation**

Table 8.166: LayoutPreparationParams Resource (Sheet 1 of 6)

NAME	DATA TYPE	DESCRIPTION
BindingEdge ? New in JDF 1.3	enumeration	Indicates which finished page edge should be bound. The binding edge is defined relative to the orientation of the page cell containing the first reader page in the finished print component with content on it. Allowed values are: Left Right Top Bottom None
BackMarkList ?	NMTOKENS	List of marks that are to be marked on each back surface. The appearance of the marks are defined by the process implementation. Values include: CIELABMeasuringField ColorControlStrip ColorRegisterMark CutMark DensityMeasuringField IdentificationField JobField PaperPathRegisterMark RegisterMark ScavengerArea
CreepValue ?	XYPair	This parameter specifies horizontal and vertical creep compensation value in points. The first value specifies the creep compensation of all horizontal gutters, and the second value specifies the creep compensation of all vertical gutters. The numbers specify the distance in points by which the respective explicitly creeping gutter either increments (positive values) or decrements (negative values) in width from one sheet to the next for a given sequence of sheets related to the same bound component. If not specified, it MAY be calculated based on the information taken from media.

Table 8.166: LayoutPreparationParams Resource (Sheet 2 of 6)

NAME	DATA TYPE	DESCRIPTION
<i>FinishingOrder</i> = "GatherFold"	enumeration	<p>Specifies the order of operations for finishing a bound booklet created from multiple imposed sheets.</p> <p>The LayoutPreparation process uses this information (in addition to the values of <i>@PageDistributionScheme</i> and <i>@FoldCatalog</i>) in order to completely determine how content pages are distributed on the sequence of sheets that comprise the pages of a single booklet.</p> <p>Allowed values are:</p> <p>FoldGather – The sheets of a document are first folded according to the value of the <i>@FoldCatalog</i> attribute and then gathered on a pile. Usually applies to finishing of perfect-bound documents.</p> <p>FoldCollect – The sheets of a document are first folded, according to the value of the <i>@FoldCatalog</i> attribute, and then collected on a saddle. Usually applies to finishing of both perfect-bound and saddle-stitched booklets.</p> <p>Gather – The sheets of a document are gathered on a pile. No folding is assumed.</p> <p>GatherFold – The sheets of a document are first gathered on a pile then folded according to the value of the <i>@FoldCatalog</i> attribute. Usually applies to finishing of both perfect-bound and saddle-stitched booklets.</p>
<i>FoldCatalog</i> ?	string	<p>Description of the type of fold that will be applied to all printed sheets.</p> <p>The LayoutPreparation process uses the fold description specified by this attribute (in addition to the values of <i>@PageDistributionScheme</i> and <i>@FinishingOrder</i>) to determine the proper distribution of pages on the surfaces of the sheets</p> <p>If not present, no folding other than the folding that is implied by <i>@PageDistributionScheme</i>="Saddle" is assumed.</p> <p>Values include those from: ▶ Fold Catalog.</p>
<i>FoldCatalogOrientation</i> ="Rotate0" New in JDF 1.3	enumeration	<p>This attribute specifies the orientation of how the identified fold catalog entry SHALL be interpreted for the purposes of mapping input pages onto the imposition layout (not for purposes of performing the folding, if any, or orienting the sheet).</p> <p>Allowed value is from: ▶ Orientation.</p>
<i>FrontMarkList</i> ?	NMTOKENS	<p>List of marks that are to be marked on each front surface. The appearance of the marks are defined by the process implementation.</p> <p>Values include:</p> <p>See @BackMarkList.</p>
<i>Gutter</i> ? Modified in JDF 1.2	XYPair	<p>Width of the horizontal and vertical gutters formed between rows and columns of page cells of a multi-up sheet layout. The gutter width is defined as the distance between the <i>PageCell</i>/<i>@TrimSize</i> defined trim boxes of adjacent page cells. The first value specifies the width of all horizontal gutters, and the second value specifies the width of all vertical gutters. If no gutters are defined because either the <i>@NumberUp</i> attribute is not specified or its explicit values are equal to one, this attribute SHALL be ignored.</p> <p>In the case where a gutter is identified as creeping by either <i>@VerticalCreep</i> or <i>@HorizontalCreep</i>, then the values of <i>@Gutter</i> specify the initial width of explicitly creeping gutters where the gutter width may increment or decrement depending on the <i>@CreepValue</i> attribute. If a value of <i>@CreepValue</i> is negative then <i>@Gutter</i> SHALL be interpreted as the starting gutter width of the outermost sheet; otherwise it SHALL be interpreted as the starting gutter width of the innermost sheet.</p> <p><i>@Gutter</i> is applied in addition to any <i>@Border</i> specified in the <i>PageCell</i>.</p>
<i>GutterMinimumLimit</i> ? New in JDF 1.3	XYPair	<p>Specifies the minimum width of the explicitly creeping horizontal and vertical gutter(s). If an explicitly creeping gutter shrinks to a width equal to or less than this value, all subsequent gutters SHALL be set to this value. If <i>@GutterMinimumLimit</i> is specified and neither <i>@Gutter</i> nor <i>@CreepValue</i> is specified, the device SHOULD calculate creep in a device specific manner.</p>

Table 8.166: LayoutPreparationParams Resource (Sheet 3 of 6)

NAME	DATA TYPE	DESCRIPTION
<p><i>HorizontalCreep</i> ? Modified in JDF 1.2</p>	IntegerList	<p>Specifies which horizontal gutters creep. The allowed values are zero-based indexes that reference horizontal gutters formed by multiple rows of pages in a multi-up page layout specified by the second value of <i>@NumberUp</i>. The value for an entry in this list SHALL be between zero and two (2) less then the second value of <i>@NumberUp</i>.</p> <p>If not specified, then horizontal gutters SHALL NOT creep.</p> <p>Gutters identified by this attribute are known as explicitly creeping gutters whereas those not identified are known as implicitly creeping gutters.</p> <p>Note: In order preserve the absolute position of the center lines of all gutters across all sheets, only specify alternating gutters starting with gutter index zero.</p>
<p><i>ImplicitGutter</i> ? New in JDF 1.3</p>	XYPair	<p>Specifies the initial gutter width in points for implicitly creeping horizontal and vertical gutters. The first number corresponds to horizontal gutters and the second number corresponds to vertical gutters. The particular sheet to which this initial gutter applies (innermost or outermost) depends upon the polarity of the creep increment specified by <i>@CreepValue</i> (see <i>@Gutter</i>).</p>
<p><i>ImplicitGutterMinimumLimit</i> ? New in JDF 1.3</p>	XYPair	<p>Specifies the minimum width in points of implicitly creeping vertical and horizontal gutter(s). If an implicitly creeping gutter shrinks to a width equal to or less than this value, all subsequent gutters SHALL be set to this value.</p>
<p><i>NumberUp</i> ?</p>	XYPair	<p>Specifies a regular, multi-up grid of <i>PageCell</i> elements into which content finished pages are mapped. The first value specifies the number of columns of page cells and the second value specifies the number of rows of page cells in the multi-up grid (both numbers are integers).</p> <p>The relative positioning of the page cells within the multi-up grid are defined by the explicit or implied values of the <i>@Gutter</i>, <i>@HorizontalCreep</i>, <i>@VerticalCreep</i> and <i>@CreepValue</i> attributes.</p> <p>The distribution of content pages from the content <i>RunList</i> into the page cells is defined by the explicit or implied values of the <i>@PageDistributionScheme</i>, <i>@PresentationDirection</i>, <i>@Sides</i>, <i>@FinishingOrder</i> and <i>@FoldCatalog</i> attributes and the implicit number of sheets comprising the bound component.</p>
<p><i>PageDistributionScheme="Sequential"</i> Modified in JDF 1.5</p>	NMTOKEN	<p>Specifies how finished pages are to be distributed onto a multi-up grid of finished <i>PageCell</i> elements defined by the values of the <i>@NumberUp</i> attribute.</p> <p>Values include those from: ▶ Table 8.167 PageDistributionScheme Attribute Values</p> <p>Note: Page distribution ordering depends upon the implied number of sheets per finished <i>Component</i> and how the imposed sheets are to be folded during finishing as well as the order of gathering and folding. Refer to the <i>@FoldCatalog</i> and <i>@FinishingOrder</i> attributes.</p> <p>Note: The <i>@NumberUp</i> attribute SHALL always specify a multi-up layout appropriate for a given finished page distribution ordering and <i>@FoldCatalog</i>. Setting this attribute does not imply the multi-up grid dimensions are appropriate for the selected page distribution scheme.</p> <p>Note: In all cases, the order of finished pages as represented by the content <i>RunList</i> SHALL be either in reader order or in an order appropriate for multi-up saddle stitching. Refer to the <i>@PageOrder</i> attribute.</p> <p>Modification note: Starting with JDF 1.5, there are new values.</p>
<p><i>PageOrder="Reader"</i></p>	NMTOKEN	<p>The assumed ordering of the finished pages in the <i>RunList</i>.</p> <p>Values include:</p> <p>Booklet – The finished pages are ordered in the <i>RunList</i> and SHALL be processed exactly in the order as specified by <i>@PresentationDirection</i>. <i>@NumberUp</i> SHALL still be set to the appropriate value and is not implied by specifying <i>@PageOrder="Booklet"</i>. <i>@PageOrder="Booklet"</i> SHALL NOT be used in conjunction with <i>@FoldCatalog</i>.</p> <p>Reader – The finished pages are in reader order in the <i>RunList</i>.</p>

Table 8.166: LayoutPreparationParams Resource (Sheet 4 of 6)

NAME	DATA TYPE	DESCRIPTION															
<i>PresentationDirection</i> ?	enumeration	<p>Indicates the order in which finished pages will be distributed into the page cells of the <i>@NumberUp</i> layout. If <i>@PageDistributionScheme</i>="Saddle", <i>@PresentationDirection</i> applies to sets of two adjacent pages. This allows positioning of multiple page pairs for saddle stitching onto one sheet.</p> <p>Allowed values are:</p> <p>FoldCatalog – Finished pages are imaged so that the result is compatible with a finished product produced from the folding catalog as specified in <i>@FoldCatalog</i>.</p> <p>XYZ – Permutations of the letters XYZ and xyz so that exactly one of upper or lower case of x, y and z define the order in which finished pages SHALL be flowed along each axis with respect to the coordinate system of the front side of the sheet. In case of duplex printing, where z is specified first, the pages from the original PDL that immediately follow a page that is imaged on the front side of the sheet shall be positioned on the back side of the media back-to-back to the position of the front page. If Z is specified first, the pages from the original PDL that immediately precede a page that is imaged on the front side of the sheet shall be positioned on the back side of the media back-to-back to the position of the front page.</p> <p>Note: This restriction for duplex printing ensures that <i>@PresentationDirection</i> values that can represent cut & stack impositions create stacks of correctly aligned front and back pages. The first letter of the triplet specifies the initial axis of flow. The second letter of the triplet specifies the second axis of flow and so on.</p> <p>X – Specifies flowing left to right across a sheet surface. x – Specifies flowing right to left across a sheet surface. Y – Specifies flowing bottom to top vertically across a sheet surface. y – Specifies flowing top to bottom vertically across a sheet surface. Z – Specifies flowing bottom of stack to top of it through the stack. z – Specifies flowing top of stack to bottom of it through the stack.</p> <p>Examples: The following table specifies how cells are ordered on a simplex 4-up layout for a 2-sheet stack depending on <i>@PresentationDirection</i>. In each example, the left set of 4 numbers represent the top sheet as seen from the top and the right set of 4 numbers represent the bottom sheet as seen after the stack is turned along the y-axis of the 2-sheet stack.</p> <table border="1"> <thead> <tr> <th><i>Xyz</i></th> <th><i>xyz</i></th> <th><i>XYZ</i></th> <th><i>Zxy</i></th> <th><i>yxZ</i></th> </tr> </thead> <tbody> <tr> <td>1 2 5 6</td> <td>2 1 6 5</td> <td>7 8 3 4</td> <td>4 2 1 3</td> <td>7 5 3 1</td> </tr> <tr> <td>3 4 7 8</td> <td>4 3 8 7</td> <td>5 6 1 2</td> <td>8 6 5 7</td> <td>8 6 4 2</td> </tr> </tbody> </table>	<i>Xyz</i>	<i>xyz</i>	<i>XYZ</i>	<i>Zxy</i>	<i>yxZ</i>	1 2 5 6	2 1 6 5	7 8 3 4	4 2 1 3	7 5 3 1	3 4 7 8	4 3 8 7	5 6 1 2	8 6 5 7	8 6 4 2
<i>Xyz</i>	<i>xyz</i>	<i>XYZ</i>	<i>Zxy</i>	<i>yxZ</i>													
1 2 5 6	2 1 6 5	7 8 3 4	4 2 1 3	7 5 3 1													
3 4 7 8	4 3 8 7	5 6 1 2	8 6 5 7	8 6 4 2													
<i>Rotate</i> ="Rotate0"	enumeration	<p>Orthogonal rotation including the implied translation to be applied to the grid of <i>PageCell</i> elements on the entire surface relative to the process coordinate system.</p> <p>Allowed values are:</p> <p>Rotate0</p> <p>Rotate90 – 90° counterclockwise rotation.</p> <p>Rotate180 – 180° rotation.</p> <p>Rotate270 – 90° clockwise rotation.</p> <p>Note: For details of orthogonal rotations, refer to ▶ Table 2.4 Matrices and Orientation values for describing the orientation of a Component. If a <i>@RotatePolicy</i> value other than "NoRotate" is specified in <i>FitPolicy</i>, the actual rotation specified in <i>@Rotate</i> MAY be modified accordingly.</p> <p>Note: A rotation of the grid also rotates the gutters (i.e., it is applied after all other parameters have been evaluated and applied).</p>															
<i>Sides</i> ="OneSidedFront"	enumeration	<p>Indicates whether the content layout is to be imaged on one or both sides of the media. When the content layout consists of multiple input <i>RunList</i> pages to be imposed on a single surface, <i>@Sides</i> applies to the entire unfolded sheet.</p> <p>When a different value for the <i>@Sides</i> attribute is encountered, it SHALL force a new sheet. However, when the same value for the <i>@Sides</i> attribute is restated for consecutive pages, it is the same as if that restatement was not present.</p> <p>Allowed values are from: ▶ Table 8.127 Sides Attribute Values.</p>															

Table 8.166: LayoutPreparationParams Resource (Sheet 5 of 6)

NAME	DATA TYPE	DESCRIPTION					
<i>StackDepth</i> ?	integer	The number of sheets in a stack that are processed when imposing down the Z axis. If not specified, the entire job defines one stack.					
<i>StepDocs</i> ? Modified in JDF 1.2	XYPair	<p>A list of two integers specifying how to impose multiple instance documents on one sheet. The first value specifies the document repeats along the X axis, the second value specifies the repeats along the Y axis. Each entry of <i>@NumberUp</i> SHALL be an integer multiple of <i>@StepRepeat</i> * <i>@StepDocs</i>. Positive values define grouped step and repeat whereas negative values define alternating step and repeat. The following examples, where documents are denoted A and B while pages are denoted 1 and 2, have <i>@PresentationDirection="Xyz"</i>, <i>@NumberUp="4 4"</i> and <i>@StepRepeat="2 2 1"</i> and <i>@StepDocs =:</i></p> <table border="1" data-bbox="564 568 1493 792"> <tr> <td data-bbox="564 568 935 792"> <p>"2 1" (2 documents in X, 1 in Y)</p> <p>A1 A1 B1 B1 A1 A1 B1 B1 A2 A2 B2 B2 A2 A2 B2 B2</p> </td> <td data-bbox="935 568 1493 792"> <p>"1 2" (1 document in X, 2 in Y)</p> <p>A1 A1 A2 A2 A1 A1 A2 A2 B1 B1 B2 B2 B1 B1 B2 B2</p> </td> </tr> </table>	<p>"2 1" (2 documents in X, 1 in Y)</p> <p>A1 A1 B1 B1 A1 A1 B1 B1 A2 A2 B2 B2 A2 A2 B2 B2</p>	<p>"1 2" (1 document in X, 2 in Y)</p> <p>A1 A1 A2 A2 A1 A1 A2 A2 B1 B1 B2 B2 B1 B1 B2 B2</p>			
<p>"2 1" (2 documents in X, 1 in Y)</p> <p>A1 A1 B1 B1 A1 A1 B1 B1 A2 A2 B2 B2 A2 A2 B2 B2</p>	<p>"1 2" (1 document in X, 2 in Y)</p> <p>A1 A1 A2 A2 A1 A1 A2 A2 B1 B1 B2 B2 B1 B1 B2 B2</p>						
<i>StepRepeat</i> ?	IntegerList	<p>A list of three integers that specifies the number of identical pages to impose. The first value specifies the repeats along the X axis, the second value specifies the repeats along the Y axis, and the third value specifies the repeats down the stack — the Z axis. Each entry of <i>@NumberUp</i> SHALL be an integer multiple of <i>@StepRepeat</i> * <i>@StepDocs</i>. Positive values define grouped step and repeat, whereas negative values define alternating step and repeat. Note that negative values are illegal for the third component, since the total depth of the stack might be unknown. The following examples have <i>@PresentationDirection="Xyz"</i>, <i>@NumberUp="4 4"</i> and <i>@StepRepeat =:</i></p> <table border="1" data-bbox="564 1093 1493 1285"> <tr> <td data-bbox="564 1093 743 1285"> <p>"2 2 1"</p> <p>1 1 2 2 1 1 2 2 3 3 4 4 3 3 4 4</p> </td> <td data-bbox="743 1093 935 1285"> <p>"-2 2 1"</p> <p>1 2 1 2 1 2 1 2 3 4 3 4 3 4 3 4</p> </td> <td data-bbox="935 1093 1126 1285"> <p>"-2 -2 1"</p> <p>1 2 1 2 3 4 3 4 1 2 1 2 3 4 3 4</p> </td> <td data-bbox="1126 1093 1318 1285"> <p>"2 -2 1"</p> <p>1 1 2 2 3 3 4 4 1 1 2 2 3 3 4 4</p> </td> <td data-bbox="1318 1093 1493 1285"> <p>"1 4 1"</p> <p>1 2 3 4 1 2 3 4 1 2 3 4 1 2 3 4</p> </td> </tr> </table>	<p>"2 2 1"</p> <p>1 1 2 2 1 1 2 2 3 3 4 4 3 3 4 4</p>	<p>"-2 2 1"</p> <p>1 2 1 2 1 2 1 2 3 4 3 4 3 4 3 4</p>	<p>"-2 -2 1"</p> <p>1 2 1 2 3 4 3 4 1 2 1 2 3 4 3 4</p>	<p>"2 -2 1"</p> <p>1 1 2 2 3 3 4 4 1 1 2 2 3 3 4 4</p>	<p>"1 4 1"</p> <p>1 2 3 4 1 2 3 4 1 2 3 4 1 2 3 4</p>
<p>"2 2 1"</p> <p>1 1 2 2 1 1 2 2 3 3 4 4 3 3 4 4</p>	<p>"-2 2 1"</p> <p>1 2 1 2 1 2 1 2 3 4 3 4 3 4 3 4</p>	<p>"-2 -2 1"</p> <p>1 2 1 2 3 4 3 4 1 2 1 2 3 4 3 4</p>	<p>"2 -2 1"</p> <p>1 1 2 2 3 3 4 4 1 1 2 2 3 3 4 4</p>	<p>"1 4 1"</p> <p>1 2 3 4 1 2 3 4 1 2 3 4 1 2 3 4</p>			
<i>SurfaceContentsBox</i> ? Modified in JDF 1.1A	rectangle	<p>This box, specified in <i>Layout</i> coordinate space, defines the area into which <i>PageCell</i> elements are distributed. The lower left corner of the rectangle specified by the value of this attribute establishes the coordinate system onto which the content is mapped and SHOULD have a value of "0 0". <i>@SurfaceContentsBox</i> MAY imply clipping. This attribute SHOULD be supplied in order to obtain predictable placement of content. If this attribute is not supplied, a rectangle with the origin at "0 0" and an extent that MAY be dependent on the dimensions of the <i>Media</i> is implied.</p>					
<i>VerticalCreep</i> ?	IntegerList	<p>Specifies which vertical gutters creep. The allowed values are zero-based indexes that reference vertical gutters. These are formed by multiple columns of pages in a multi-up page layout specified by the first value of <i>@NumberUp</i>. The value for an entry in this list SHALL be between zero and two (2) less than the first value of <i>@NumberUp</i>. An index value outside of this range is ignored. If not specified, then vertical gutters SHALL NOT creep.</p> <p>Gutters identified by this attribute are known as explicitly creeping gutters whereas those not identified are known as implicitly creeping gutters.</p> <p>Note: In order to preserve the absolute position of the center lines of all gutters across all sheets, only specify alternating gutters starting with gutter index zero.</p>					
<i>DeviceMark</i> ?	element	Details how device-dependent marks are to be generated. If not specified, the marks are device-dependent.					

Table 8.166: LayoutPreparationParams Resource (Sheet 6 of 6)

NAME	DATA TYPE	DESCRIPTION
ExternalImpositionTemplate ? New in JDF 1.3	reference	Reference to an external imposition template in a proprietary format. LayoutPreparationParams SHOULD NOT contain information that overlaps information specified in ExternalImpositionTemplate . Information specified in LayoutPreparationParams overrides parameters specified in ExternalImpositionTemplate .
FitPolicy ?	element	Details how to fit the grid of PageCell elements onto the @SurfaceContentsBox .
ImageShift ?	element	Details how to place the grid of PageCell elements into the @SurfaceContentsBox . ImageShift SHALL be applied before any transformations of the grid of PageCell elements as specified by @Rotate or FitPolicy . The reference origin of the grid of page cells is the lower left corner of the trim box of the lower left page cell of the grid of the first sheet prior to applying any creep. Note that ImageShift will generally be required to allow for space when @CreepValue is positive.
InsertSheet *	reference	Additional sheets to be inserted before, after or within a job.
JobField *	element	Specific information about this kind of mark object.
Media ?	reference	Specific information about the media.
PageCell ? Modified in JDF 1.1A	element	PageCell elements describe how page contents will be imaged onto individual page cells. At most one PageCell SHALL be specified and it is applied to all page cells on both surfaces of a sheet.

Figure 8-32: Cut and stack imposition example



Table 8.167: PageDistributionScheme Attribute Values (Sheet 1 of 2)

VALUE	DESCRIPTION
Perfect	Distribute finished pages onto a sequence of one or more signatures in proper order for perfect binding. For this page distribution scheme, creep is usually not used.
PerfectFront New in JDF 1.5	Distribute finished pages onto a sequence of one or more signatures in proper order for perfect binding. Only front pages, in finished product reader order, are placed in the signature layout. For left hand binding, only right facing page cells contain pages and left facing page cells are empty. For right hand binding, only left facing page cells contain pages and right facing page cells are empty. For top binding, only bottom facing page cells contain pages and top facing page cells are empty. For bottom binding, only top facing page cells contain pages and bottom facing page cells are empty. For this page distribution scheme, creep is usually not used.
Saddle	Distribute finished pages onto a sequence of one or more imposition layouts in proper order for saddle stitch binding. For this page distribution scheme, creep SHALL be applied only to odd-numbered vertical gutters where any even-numbered gutters SHALL automatically creep in the opposite direction.

Table 8.167: PageDistributionScheme Attribute Values (Sheet 2 of 2)

VALUE	DESCRIPTION
SaddleFront New in JDF 1.5	Distribute finished pages onto a sequence of one or more imposition layouts in proper order for saddle stitch binding where only the reader order front pages respective of the finished product are placed in the signature layout. For left hand binding, only right facing page cells contain pages and left facing page cells are empty. For right hand binding, only left facing page cells contain pages and right facing page cells are empty. For top binding, only bottom facing page cells contain pages and top facing page cells are empty. For bottom binding, only top facing page cells contain pages and bottom facing page cells are empty. For this page distribution scheme, creep SHALL be applied only to odd-numbered vertical gutters where any even-numbered gutters SHALL automatically creep in the opposite direction.
Sequential	The finished pages are distributed onto the multi-up layout according to the value of the @PresentationDirection attribute.

8.87.1 PageCell

Table 8.168: PageCell Element (Sheet 1 of 2)

NAME	DATA TYPE	DESCRIPTION
Border ? Modified in JDF 1.1A	double	<p>A number indicating the width in points of a drawn border line, that appears around the trim region specified by the explicit or implied value of @TrimSize. A value of "0" specifies no border.</p> <p>If the value of this attribute is non-zero and positive, then a border of that specified width will be drawn to the outside of the page cell whose inside dimension is the same as the explicit or implied value of the @TrimSize attribute. The border marks SHALL NOT overwrite the page contents of the trimmed page. Note that when the page cells are distributed evenly over the area of the @SurfaceContentsBox, the page cells position and/or size can be adjusted to accommodate the border.</p> <p>If the value of this attribute is non-zero and negative, then a border of a width specified by the absolute value of this attribute will be drawn to the inside of the page cell whose outside dimension is the same as the explicit or implied value of the @TrimSize attribute. The border marks MAY overwrite the page contents of the trimmed page.</p> <p>The rectangle defined by the inside edge of the border defines a @ClipBox beyond which no content will be imaged.</p>
ClipBox ?	rectangle	<p>Defines a rectangle with an origin relative to the lower left corner of the page cell rectangle defined by the explicit or implied value of the @TrimSize attribute. Page content data imaged outside of the region defined by this rectangle SHALL be clipped. If @ClipBox is larger than @TrimSize, it is used to specify a bleed region. If not specified, its default value is "0 0 X Y" where X and Y are the explicit or implied values of @TrimSize.</p>
MarkList ?	NMTOKENS	<p>List of marks that are to be marked on each page cell. The appearance of the marks are defined by the process implementation.</p> <p>Values include:</p> <ul style="list-style-type: none"> CIELABMeasuringField ColorControlStrip ColorRegisterMark CutMark DensityMeasuringField IdentificationField JobField PaperPathRegisterMark RegisterMark ScavengerArea

Table 8.168: PageCell Element (Sheet 2 of 2)

NAME	DATA TYPE	DESCRIPTION
<i>Rotate</i> ="Rotate0"	enumeration	Orthogonal rotation to be applied to the contents in each page cell. Allowed values are: <i>Rotate0</i> <i>Rotate90</i> – 90° counterclockwise rotation. <i>Rotate180</i> – 180° rotation. <i>Rotate270</i> – 90° clockwise rotation. Note: For details of orthogonal rotation, refer to ▶ Table 2.4 Matrices and Orientation values for describing the orientation of a Component. If a <i>@RotatePolicy</i> value other than "NoRotate" is specified in <i>FitPolicy</i> , the actual rotation specified in <i>@Rotate</i> MAY be modified accordingly.
<i>TrimSize</i> ? Modified in JDF 1.1A	XYPair	Defines the dimensions of the page cell. The lower left corner of the rectangle specified by the value of this attribute establishes the coordinate system into which the page content is mapped. If not specified, <i>@TrimSize</i> is calculated by subtracting the gutters from the <i>LayoutPreparationParams</i> / <i>@SurfaceContentsBox</i> and dividing by the appropriate <i>@NumberUp</i> value.
<i>Color</i> ?	reference	Color of the border.
<i>DeviceMark</i> ?	element	Details how device dependent marks are to be generated. Defaults to the value of <i>DeviceMark</i> in the parent <i>LayoutPreparationParams</i> .
<i>FitPolicy</i> ?	element	Details how page content is fit into the page cells. If the dimensions of the page contents vary, <i>FitPolicy</i> is applied to the contents of each cell individually.
<i>ImageShift</i> ?	element	Element which describes how content SHALL be placed into the page cells. X and Y are specified in the coordinate system of the <i>PageCell</i> .

8.87.2 ImageShift

ImageShift elements describe how the grid of page cells will be imaged onto media, when *ImageShift* is specified in the context of *LayoutPreparationParams*. When *ImageShift* is specified in the context of a *PageCell*, it specifies how content is imaged into the respective page cells.

Table 8.169: ImageShift Element (Sheet 1 of 2)

NAME	DATA TYPE	DESCRIPTION
<i>PositionX</i> ?	enumeration	Indicates how content SHALL be positioned horizontally. The <i>@ShiftBack</i> and <i>@ShiftFront</i> are applied after <i>@PositionX</i> and <i>@PositionY</i> . Allowed values are: <i>Center</i> – Center the content horizontally without regard to limitations of the receiving container. <i>Left</i> – Position the left edge of the content so that it is coincident with the left edge of the receiving container. <i>Right</i> – Position the right edge of the content so that it is coincident with the right edge of the receiving container. <i>Spine</i> – Position the content so that it is coincident with the vertical binding edge of the receiving container. New in JDF 1.2 <i>None</i> – Place the content wherever the print data specify. Deprecated in JDF 1.3

Table 8.169: ImageShift Element (Sheet 2 of 2)

NAME	DATA TYPE	DESCRIPTION
<i>PositionY</i> ?	enumeration	Indicates how content SHALL be positioned vertically. The <i>@ShiftBack</i> and <i>@ShiftFront</i> are applied after <i>@PositionX</i> and <i>@PositionY</i> . Allowed values are: Bottom – Position the bottom edge of the content so that it is coincident with the bottom edge of the receiving container. Center – Center the content horizontally without regard to limitations of the receiving container. Top – Position the top edge of the content so that it is coincident with the top edge of the receiving container. Spine – Position the content so that it is coincident with the horizontal binding edge of the receiving container. New in JDF 1.2 None – Place the content wherever the print data specify. Deprecated in JDF 1.3
<i>ShiftBack</i> ?	XYPair	The amount in X and Y direction by which the content SHALL be shifted on the back side of the receiving container. If not specified, <i>@ShiftBack</i> SHALL be calculated from <i>@ShiftFront</i> so that the content remains aligned.
<i>ShiftFront</i> ="0 0"	XYPair	The amount in X and Y direction by which the content SHALL be shifted on the front side of the receiving container.

Example 8.32: LayoutPreparationParams for cross folded saddle stiched imposition.

The figure below illustrates the **JDF** in this example. It demonstrates a 4-up, cross folded, saddle stitched imposition with vertical gutter creep. The **JDF** assumes that the dimensions of the *RunList* page's trim rectangle matches *PageCell/@TrimSize*, whose dimensions are m by n (width and height) in the **JDF** example below. The sheet with the widest creep gutter is on the top of the logical sheet stack.

The following terms are used in the figure:

- **reference grid** refers to the dashed red box around page cells of outermost sheet, which indicates the size of the reference grid used in calculating grid placement relative to the *@SurfaceContentsBox* origin using *LayoutPreparationParams/@ImageShift*
- **SCBxo, SCByo, SFx, SFy, m, n** and **vg** are used in the **JDF** example below.

Figure 8-33: Diagram of a 4-up cross-folded saddle-stitch imposition with vertical gutter creep

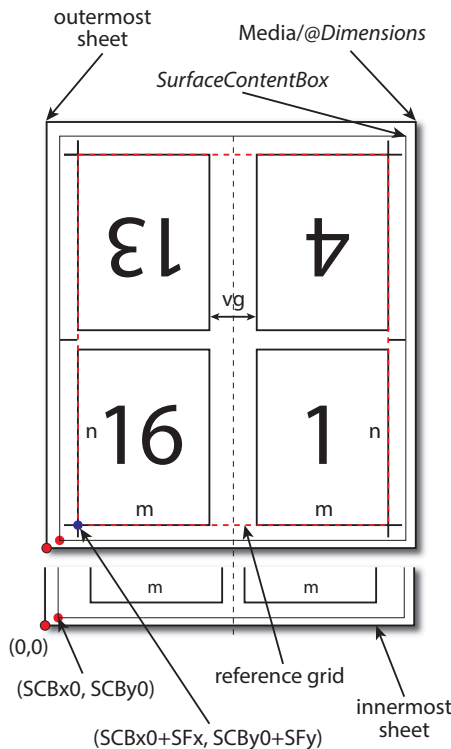

```

<LayoutPreparationParams BindingEdge="Left" Class="Parameter"
  CreepValue="0 -5" FinishingOrder="FoldCollect" FoldCatalog="F8-7"
  FoldCatalogOrientation="Flip270" FrontMarkList="CutMark"
  Gutter="20 20" GutterMinimumLimit="5 5" ID="LPP_2" NumberUp="2 2"
  PageDistributionScheme="Saddle" Sides="TwoSidedFlipY"
  Status="Available" StepRepeat="1 1 1"
  SurfaceContentsBox="0 0 612 792" VerticalCreep="0">
  <!-- Note: the value of some attributes in LayoutPreparationParams and
    subElements relate to symbols in the above Figure:
    SurfaceContentsBox="SCBx0 SCBy0 SCBx1 SCBy1"
    GutterMinimumLimit="hml vml"
    CreepValue="0 -vc"
    Gutter="hg vg"
    TrimSize="m n"
    ShiftFront="SFx SFy"
  -->
  <PageCell TrimSize="612 792">
    <ImageShift PositionX="Spine" PositionY="Center"/>
  </PageCell>
  <ImageShift PositionX="Left" PositionY="Bottom" ShiftFront="20 20"/>
</LayoutPreparationParams>

```

Example 8.33: LayoutPreparationParams for step and repeat saddle stitched imposition

The figure below illustrates the **JDF** in this example. It demonstrates a 2-up, step-and-repeat, saddle stitched imposition with vertical spine gutter creep. The **JDF** assumes that the dimensions of source content page rectangle matches **PageCell/@TrimSize**, whose dimensions are m by n (width and height) in the **JDF** example below.

The following terms are used in the figure:

- **reference grid** refers to the dashed red box around page cells of innermost sheet, which indicates the size of the reference grid used in calculating grid placement relative to the **@SurfaceContentsBox** origin using **LayoutPreparationParams/@ImageShift**
- **SCBxo**, **SCByo**, **SFx**, **SFy**, **m**, **n**, **vg** and **vig** are used in the **JDF** below.

Figure 8-34: Diagram of a step-and-repeat 2-up saddle-stitch imposition with vertical spine gutter creep

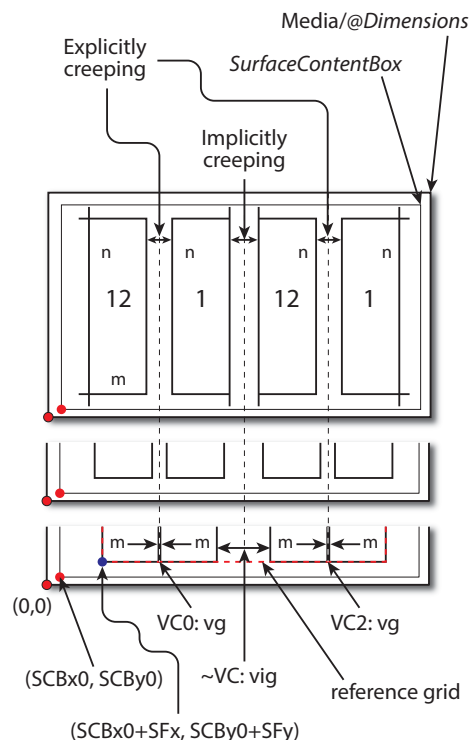

RESOURCES

```

<LayoutPreparationParams Class="Parameter" CreepValue="0 5"
  FinishingOrder="GatherFold" FoldCatalog="F4-1"
  FoldCatalogOrientation="Flip0" FrontMarkList="CutMark"
  Gutter="0 10" ID="LPP_1" ImplicitGutter="0 30"
  ImplicitGutterMinimumLimit="0 20" NumberUp="4 1"
  PageDistributionScheme="Saddle" Sides="TwoSidedFlipY"
  Status="Available" StepRepeat="2 1 1"
  SurfaceContentsBox="0 0 612 792" VerticalCreep="0 2">
  <!-- Note: folding pattern F4-1 applies to each of the two 2x1 signatures
    Note: step and repeat by two in X direction logically divides grid
    into two 2x1 signatures
    Note: first (VC0) and third (VC2) vertical gutters are explicitly
    creeping and the rest (~VC) are implicitly creeping
  Note: Positive vertical creep value indicates initial gutter
    Widths of inner most Sheet
  Note: cut marks are located relative to largest page cell grid trim box
  Note: the value of some attributes in LayoutPreparationParams and subElements
    relate to symbols in the above Figure:
    SurfaceContentsBox="SCBx0 SCBx1 SCBy0 SCBy1"
    ImplicitGutter="0 vig"
    ImplicitGutterMinimumLimit="0 vig1"
    CreepValue="0 +vc"
    Gutter="0 vg"
    TrimSize="m n"
    ShiftFront="SFx SFy"
  -->
  <PageCell TrimSize="612 792">
    <ImageShift PositionX="Spine" PositionY="Bottom"/>
  </PageCell>
  <ImageShift PositionX="Left" PositionY="Bottom" ShiftFront="20 20"/>
</LayoutPreparationParams>

```

8.88 LayoutShift

New in JDF 1.4.

LayoutShift defines the parameters for separation dependent paper stretch compensation.

Resource Properties

Resource Class: Parameter
 Example Partition: @SheetName, @Side, @Separation
 Input of Processes: LayoutShifting

Table 8.170: LayoutShift Resource

NAME	DATA TYPE	DESCRIPTION
ShiftPoint +	element	Description of separation dependent transformations for a given point on the Layout .

8.88.1 ShiftPoint

Table 8.171: ShiftPoint Element

NAME	DATA TYPE	DESCRIPTION
CTM	matrix	@CTM that SHALL be applied to the separation after all other transformations.
Position	XYPair	Point that this ShiftPoint applies to. Note: The interpolation algorithm between ShiftPoint positions is implementation dependent.

Example 8.34: LayoutShift

New in JDF 1.4.

Example of modifying the absolute positions of the "Black" separation with `ShiftPoint/@Position`.

```

<!-- LayoutShift SHOULD be partitioned: at least Side and Separation
will make sense -->
<LayoutShift Class="Parameter" ID="r000005"
PartIDKeys="Side Separation" Status="Unavailable">
  <!-- LayoutShift SHOULD be partitioned: at least Side and Separation
will make sense-->
  <!-- Note that the interpolation algorithm between positions is
implementation dependent-->
  <LayoutShift Side="Front">
    <LayoutShift Separation="Cyan">
      <ShiftPoint CTM="1 0 0 1 0 0" Position="360 500"/>
      <ShiftPoint CTM="1 0 0 1 0 2" Position="1800 500"/>
      <ShiftPoint CTM="1 0 0 1 1 0" Position="360 1500"/>
      <ShiftPoint CTM="1 0 0 1 1 2" Position="1800 1500"/>
      <ShiftPoint CTM="1 0 0 1 2 0" Position="360 2500"/>
      <ShiftPoint CTM="1 0 0 1 2 2" Position="1800 2500"/>
      <ShiftPoint CTM="1 0 0 1 3 0" Position="360 3500"/>
      <ShiftPoint CTM="1 0 0 1 3 2" Position="1800 3500"/>
    </LayoutShift>
    <LayoutShift Separation="Magenta">
      <ShiftPoint CTM="1 0 0 1 1 1" Position="360 500"/>
      <ShiftPoint CTM="1 0 0 1 1 3" Position="1800 500"/>
      <ShiftPoint CTM="1 0 0 1 2 1" Position="360 1500"/>
      <ShiftPoint CTM="1 0 0 1 2 3" Position="1800 1500"/>
      <ShiftPoint CTM="1 0 0 1 3 1" Position="360 2500"/>
      <ShiftPoint CTM="1 0 0 1 3 3" Position="1800 2500"/>
      <ShiftPoint CTM="1 0 0 1 4 1" Position="360 3500"/>
      <ShiftPoint CTM="1 0 0 1 4 3" Position="1800 3500"/>
    </LayoutShift>
    <LayoutShift Separation="Yellow">
      <ShiftPoint CTM="1 0 0 1 2 2" Position="360 500"/>
      <ShiftPoint CTM="1 0 0 1 2 4" Position="1800 500"/>
      <ShiftPoint CTM="1 0 0 1 3 2" Position="360 1500"/>
      <ShiftPoint CTM="1 0 0 1 3 4" Position="1800 1500"/>
      <ShiftPoint CTM="1 0 0 1 4 2" Position="360 2500"/>
      <ShiftPoint CTM="1 0 0 1 4 4" Position="1800 2500"/>
      <ShiftPoint CTM="1 0 0 1 5 2" Position="360 3500"/>
      <ShiftPoint CTM="1 0 0 1 5 4" Position="1800 3500"/>
    </LayoutShift>
    <LayoutShift Separation="Black">
      <ShiftPoint CTM="1 0 0 1 3 3" Position="360 500"/>
      <ShiftPoint CTM="1 0 0 1 3 5" Position="1800 500"/>
      <ShiftPoint CTM="1 0 0 1 4 3" Position="360 1500"/>
      <ShiftPoint CTM="1 0 0 1 4 5" Position="1800 1500"/>
      <ShiftPoint CTM="1 0 0 1 5 3" Position="360 2500"/>
      <ShiftPoint CTM="1 0 0 1 5 5" Position="1800 2500"/>
      <ShiftPoint CTM="1 0 0 1 6 3" Position="360 3500"/>
      <ShiftPoint CTM="1 0 0 1 6 5" Position="1800 3500"/>
    </LayoutShift>
  </LayoutShift>
</LayoutShift>

```

8.89 LongitudinalRibbonOperationParams

Deprecated in JDF 1.1.

8.90 ManualLaborParams

New in JDF 1.1

`ManualLaborParams` describes the parameters to qualify generic manual work within graphic arts production. Additional `Comment` elements will generally be needed to describe the work in human readable form.

Resource Properties

Resource Class: Parameter

Input of Processes: **ManualLabor**

Table 8.172: ManualLaborParams Resource

NAME	DATA TYPE	DESCRIPTION
<i>LaborType</i> Modified in JDF 1.4	NMTOKEN	Type of manual labor that is performed. Values include: <i>CarvePotato</i> – Carve a potato for potato printing. <i>CreateCoatingForm</i> – Create a form to apply coatings during or after printing. <i>EditArt</i> – Unspecific art editing (for work on specific files LayoutElementProduction SHALL be used). <i>EditMarks</i> – Marks editing. <i>EditTraps</i> – Traps editing. <i>ManageJob</i> – General work on the job. <i>PhoneCallToCustomer</i> – Phone calls to ask/inform the customer. <i>SeparateBlanks</i> – Manual separation of blanks from a sheet after die cutting. New in JDF 1.4 Modification note: Starting with JDF 1.3 , the data type is changed from the erroneous NMTOKENS.

8.91 Media

Media describes a physical element that represents a raw, unexposed printable surface such as a paper sheet, film or plate. *@Gloss*, *@MediaColorName* and *@Opacity* attributes provide media characteristics pertinent to color management.

Resource Properties

Resource Class: Consumable

Resource referenced by: *Color/Media*, *Media*, *DieLayout*, *DigitalPrintingParams*, *EmbossingParams/Emboss*, *ExposedMedia*, *FeedingParams/Feeder*, *FeedingParams/CollatingItem*, *ImageSetterParams*, *InterpretingParams*, *Layout*, *LayoutPreparationParams*, *Media/MediaLayers*, *RasterReadingParams*, *ShapeDef*, *StrippingParams*, *Tile*

Intent Pairing: *MediaIntent*, *HoleMakingIntent*, *ProofingIntent*

Example Partition: "Location", "SheetName", "Side", "SignatureName", "TileID", "WebName"

Input of Processes: **Bending**, **BoxPacking**, **Bundling**, **CaseMaking**, **ConventionalPrinting**, **ContactCopying**, **Cutting**, **DigitalPrinting**, **Embossing**, **Feeding**, **ImageSetting**, **Laminating**, **Varnishing**, **Wrapping**

Output of Processes: **Cutting**, **Feeding**

Table 8.173: Media Resource (Sheet 1 of 6)

NAME	DATA TYPE	DESCRIPTION
<i>BackBrightness</i> ? New in JDF 1.5	double	Equivalent to <i>@Brightness</i> (see below), but applied to the back surface of the Media . If not specified, the value of <i>@Brightness</i> SHALL be applied to the front and back surfaces of the Media .
<i>BackCoatingDetail</i> ? New in JDF 1.4	NMTOKEN	Identical to <i>@FrontCoatingDetail</i> (see below), but applied to the back surface of the media. If not specified, the value of <i>@FrontCoatingDetail</i> SHALL be applied to the front and back surfaces of the Media . Values include: <i>Cast</i>
<i>BackCoatings</i> ?	enumeration	Identical to <i>@FrontCoatings</i> (see below), but applied to the back surface of the media. If not specified, the value of <i>@FrontCoatingDetail</i> SHALL be applied to the front and back surfaces of the Media . Allowed value is from: ▶ Coating.
<i>BackGlossValue</i> ? New in JDF 1.2	double	Identical to <i>@FrontGlossValue</i> (see below), but applied to the back surface of the media. If not specified, the value of <i>@FrontGlossValue</i> SHALL be applied to the front and back surfaces of the Media .

Table 8.173: Media Resource (Sheet 2 of 6)

NAME	DATA TYPE	DESCRIPTION
<i>BackISOPaperSubstrate</i> ? New in JDF 1.6	enumeration	Identical to <i>@ISOPaperSubstrate</i> (see below), but applied to the back surface of paper material defined in accordance with the print substrate set forth in ▶ [ISO12647-2:2013]. If not specified, the value of <i>@ISOPaperSubstrate</i> SHALL be applied to the front and back surfaces of the <i>Media</i> . Allowed value is from: ▶ ISOPaperSubstrate.
<i>Brightness</i> ? Modified in JDF 1.5	double	Reflectance percentage of diffuse blue reflectance as defined by ▶ [ISO2470-1:2016]. The reflectance is reported per ▶ [ISO2470-1:2016] as the diffuse blue reflectance factor of the media in percent to the nearest 0.5% reflectance factor. See also <i>@BackBrightness</i> . Modification note: Starting with JDF 1.5, the brightness MAY be specified separately for the front and back surfaces by specifying both <i>@Brightness</i> and <i>@BackBrightness</i> .
<i>CIEtint</i> ? New in JDF 1.2	double	Average CIE tint value. Average CIE tint is calculated according to equations given in ▶ [TAPPI T560].
<i>CIEWhiteness</i> ? New in JDF 1.2	double	Average CIE whiteness value. Average CIE whiteness is calculated according to equations given in ▶ [TAPPI T560].
<i>ColorName</i> ? New in JDF 1.1 Deprecated in JDF 1.2	string	Link to a definition of the color specifics. The value of <i>@ColorName</i> color SHOULD match the <i>@Name</i> attribute of a <i>Color</i> defined in a <i>ColorPool</i> resource that is linked to the process using this <i>Media</i> resource. Deprecation note: Starting with JDF 1.2, use <i>@MediaColorName</i> and <i>@MediaColorNameDetails</i> .
<i>CoreWeight</i> ? New in JDF 1.3	double	Weight of the core of a roll, in grams [g].
<i>Dimension</i> ? Modified in JDF 1.4	XYPair	The X and Y dimensions of the <i>Media</i> , measured in points. <i>@Dimension</i> specifies the outer bounding box of the <i>Media</i> . The X, Y values of <i>@Dimension</i> establishes the user coordinate system into which content is mapped (i.e., the origin is in the lower left corner of the rectangle defined by 0 0 X Y). In case of "Roll" media, the X coordinate specifies the reel width and the Y coordinate specifies the length of the web in points. If a <i>@Dimension</i> coordinate is unknown, the value SHALL be "0". If not specified, the dimension is unknown. If either or both X or Y="0" (i.e., unknown), the default orientation is assumed to be portrait (i.e., Y > X). Values include those from: ▶ Appendix F Media Size. New in JDF 1.4 Modification note: Starting with JDF 1.4, the description states that <i>@Dimension</i> specifies the outer bounding box of the <i>Media</i> and new values are specified.
<i>Flute</i> ? New in JDF 1.3	NMTOKEN	Single, capital letter that specifies the flute type of corrugated media. See ▶ Section 8.91.2.2 Corrugated Media. Values include those from: ▶ Flute Types.
<i>FluteDirection</i> ? New in JDF 1.3	enumeration	Direction of the flute of corrugated media in the coordinate system of the <i>Media</i> . See ▶ Section 8.91.2.2 Corrugated Media. Allowed value is from: ▶ MediaDirection. A value of "SameDirection" SHALL NOT be specified.
<i>FrontCoatingDetail</i> ? New in JDF 1.4	NMTOKEN	Describes (beyond <i>@FrontCoatings</i>) the coating to the front surface of the media and possibly the technology used to apply the coating. Values include: Cast
<i>FrontCoatings</i> ? Modified in JDF 1.4	enumeration	What pre-process coating has been applied to the front surface of the media. Allowed value is from: ▶ Coating.
<i>FrontGlossValue</i> ? New in JDF 1.2	double	Gloss of the front side of the of the media in gloss units as defined by ▶ [ISO8254-1:2009]. Refer also to ▶ [TAPPI T480] for examples of gloss calculation.

Table 8.173: Media Resource (Sheet 3 of 6)

NAME	DATA TYPE	DESCRIPTION
<p><i>Grade</i> ? Modified in JDF 1.5 Deprecated in JDF 1.6</p>	integer	<p>The <i>@Grade</i> of the media on a scale of 1 through 5. The <i>@Grade</i> is ignored if <i>@MediaType</i> is not "Paper".</p> <p><i>@Grade</i> of paper material is defined in accordance with the paper "types" set forth in ▶ [ISO12647-2:2004].</p> <p>If a workflow supports <i>@ISOPaperSubstrate</i>, and both <i>@Grade</i> and <i>@ISOPaperSubstrate</i> are present, it SHALL use <i>@ISOPaperSubstrate</i>.</p> <p>Note: ▶ [ISO12647-2:2004] paper type attribute values do NOT align with U.S. GRACOL paper grade attribute values (e.g., ▶ [ISO12647-2:2004] type 1 does not equal U.S. GRACOL grade 1).</p> <p>The values define offset printing paper types.</p> <p>Allowed values are:</p> <ul style="list-style-type: none"> 1 – Gloss-coated paper. 2 – Matt-coated paper. 3 – Gloss-coated, web paper. 4 – Uncoated, white paper. 5 – Uncoated, yellowish paper. <p>Deprecation note: Use <i>@ISOPaperSubstrate</i> and apply the table in ▶ Section E.3 Paper Grade.</p>
<p><i>GrainDirection</i> ? New in JDF 1.1 Modified in JDF 1.3</p>	enumeration	<p>Direction of the grain in the coordinate system defined by <i>@Dimension</i>.</p> <p>Allowed value is from: ▶ MediaDirection.</p>
<p><i>HoleCount</i> ? Deprecated in JDF 1.1</p>	integer	<p>The number of holes that are to be punched in the media (either pre- or post-punched). In JDF/1.1, use <i>@HoleType</i>, <i>Hole</i> or <i>HoleLine</i>, which includes the number of holes.</p>
<p><i>HoleType</i> = "None" New in JDF 1.1</p>	enumerations	<p>Predefined hole pattern. Multiple hole patterns are allowed (e.g., 3-hole ring binding and 4-hole ring binding holes on one piece of media). For details of the hole types, refer to ▶ Appendix K Hole Pattern Catalog.</p> <p>Allowed values are:</p> <ul style="list-style-type: none"> None – No holes. Explicit – Holes are defined in a <i>HoleList</i>. <p>Allowed values are from: ▶ Appendix K Hole Pattern Catalog.</p>
<p><i>ImagableSide</i> ?</p>	enumeration	<p>Side of the chosen medium that can be marked.</p> <p>Allowed values are:</p> <ul style="list-style-type: none"> Front Back Both Neither
<p><i>InnerCoreDiameter</i> ? New in JDF 1.4</p>	double	<p>Specifies the inner diameter of the core of a roll, in points. See also <i>@OuterCoreDiameter</i> and <i>@RollDiameter</i>.</p>
<p><i>InsideLoss</i> ? New in JDF 1.3</p>	double	<p>The inside loss of corrugated board material in microns [µm]. See ▶ Section 8.91.2.1 Inside Loss and Outside Gain.</p> <p>Note: <i>@InsideLoss</i> + <i>@OutsideGain</i> NEED NOT be exactly equal to thickness.</p>
<p><i>ISOPaperSubstrate</i> ? New in JDF 1.5</p>	enumeration	<p><i>@ISOPaperSubstrate</i> supersedes <i>@Grade</i> and adds new values to allow for improved papers.</p> <p>If a workflow supports <i>@ISOPaperSubstrate</i>, and both <i>@Grade</i> and <i>@ISOPaperSubstrate</i> are present, it SHALL use <i>@ISOPaperSubstrate</i>.</p> <p><i>@ISOPaperSubstrate</i> SHALL specify the type of paper material defined in ▶ [ISO12647-2:2013].</p> <p>Allowed value is from: ▶ ISOPaperSubstrate.</p> <p>Note: See ▶ Section E.3 Paper Grade for a mapping to the paper grade values defined in ISO12647-2:2004</p>
<p><i>LabColorValue</i> ? New in JDF 1.2</p>	LabColor	<p><i>@LabColorValue</i> is the CIELAB color value of the media, computed as specified in ▶ [TAPPI T527].</p>

Table 8.173: Media Resource (Sheet 4 of 6)

NAME	DATA TYPE	DESCRIPTION
<i>MediaColorName</i> ? Modified in JDF 1.1	enumeration	A name for the color. If more specific, specialized or site-defined media color names are needed, use <i>@MediaColorNameDetails</i> . Allowed value is from: ▶ NamedColor.
<i>MediaColorNameDetails</i> ? New in JDF 1.2	string	A more specific, specialized or site-defined name for the media color. If <i>@MediaColorNameDetails</i> is supplied, <i>@MediaColorName</i> SHOULD also be supplied.
<i>MediaQuality</i> ? New in JDF 1.4	string	Named quality description of the media. Media with the same properties except for <i>@Dimension</i> SHOULD have the same value of <i>@MediaQuality</i> . For folding carton quality, multiple named quality description systems are in use (e.g., GC1, SBB, etc.). For an overview, see ▶ [Pro Carton].
<i>MediaSetCount</i> ?	integer	When the input media is grouped in sets, identifies the number of pieces of media in each set. For example, if the <i>@MediaTypeDetails</i> is "PreCutTabs", a <i>@MediaSetCount</i> of "5" would indicate that each set includes five tab sheets.
<i>MediaType</i> ? Modified in JDF 1.5	NMTOKEN	Describes the general type of the <i>Media</i> . Allowed value is from: ▶ MediaType. Note: Although the table of values in ▶ Appendix A.3.34 MediaType is declared as an enumeration the data type for <i>@MediaType</i> is, as shown, an NMTOKEN which permits other values not shown in the ▶ MediaType table.
<i>MediaTypeDetails</i> ? Modified in JDF 1.5	NMTOKEN	Additional details of the chosen medium. Constraint: If <i>@MediaTypeDetails</i> is specified, <i>@MediaType</i> SHALL be specified. Values include those from: ▶ MediaType Details.
<i>MediaUnit</i> = "Sheet" Modified in JDF 1.2	enumeration	Describes the format of the media as it is delivered to the device. Allowed values are: Continuous – Continuously connected sheets that can be fan folded. New in JDF 1.2 Roll – Continuous web on a reel. Sheet – Individual cut sheets.
<i>Opacity</i> ? Modified in JDF 1.2	enumeration	The opacity of the media. See <i>@OpacityLevel</i> to specify the degree of opacity for any of these values. Allowed value is from: ▶ Opacity.
<i>OpacityLevel</i> ? New in JDF 1.2	double	Normalized TAPPI opacity (Cn), as defined and computed in ▶ [ISO2471:2008]. Refer also to ▶ [TAPPI T519] for calculation examples.
<i>OuterCoreDiameter</i> ? New in JDF 1.3	double	Specifies the outer diameter of the core of a roll, in points. See also <i>@InnerCoreDiameter</i> and <i>@RollDiameter</i> .
<i>OutsideGain</i> ? New in JDF 1.3	double	The outside gain of corrugated board material in microns [µm]. See ▶ Section 8.91.2.1 Inside Loss and Outside Gain. Note: <i>@InsideLoss</i> + <i>@OutsideGain</i> NEED NOT be exactly equal to thickness.
<i>PlateTechnology</i> ? New in JDF 1.3 Modified in JDF 1.4	enumeration	Exposure technology of the plates. Allowed values are: FlexoAnalogSolvent New in JDF 1.4 FlexoAnalogThermal New in JDF 1.4 FlexoDigitalSolvent New in JDF 1.4 FlexoDigitalThermal New in JDF 1.4 FlexoDirectEngraving New in JDF 1.4 InkJet – Exposure with inkjet technology. Note that <i>@FrontCoatings="InkJet"</i> specifies paper or transparency media, not plates. Thermal – Thermal exposure. UV – Ultraviolet exposure. Visible – Visible light exposure.

Table 8.173: Media Resource (Sheet 5 of 6)

NAME	DATA TYPE	DESCRIPTION
<i>Polarity</i> ?	enumeration	Polarity of the chosen medium. Allowed value is from: ▶ <i>Polarity</i> .
<i>PrePrinted</i> = "false"	boolean	Indicates whether the media is preprinted.
<i>PrintingTechnology</i> ? New in JDF 1.4 Modified in JDF 1.5	NMTOKEN	Describes the printing technology that the media or coatings on the media are intended for or optimized for. Values include those from: ▶ Printing Technologies.
<i>Recycled</i> ? Deprecated in JDF 1.2	boolean	If "true", recycled media is requested. If not specified, the <i>Media</i> might have recycled content. In JDF 1.2 and beyond, use <i>@RecycledPercentage</i> .
<i>RecycledPercentage</i> ? New in JDF 1.2	double	The percentage, between 0 and 100, of recycled material that the media SHALL contain.
<i>ReliefThickness</i> ? New in JDF 1.4	double	The thickness of the relief, measured in microns [µm]. The floor thickness can be calculated as (<i>@Thickness</i> - <i>@ReliefThickness</i>). See ▶ Figure 8-36: Relief and floor thickness for a flexo plate or flexo sleeve.
<i>RollDiameter</i> ?	double	Specifies the diameter of a roll, in points. See also <i>@InnerCoreDiameter</i> and <i>@OuterCoreDiameter</i> .
<i>ShrinkIndex</i> ? New in JDF 1.1	XYPair	Specifies the ratio of the media linear dimension after shrinking to that prior to shrinking. The X value specifies the index in the major shrink axis, whereas the Y value specifies the index in the minor shrink axis. Used to describe shrink wrap media.
<i>SleeveInterlock</i> ? New in JDF 1.4	NMTOKEN	The type of interlock (or notch) to use for a flexo sleeve. Values include those from: ▶ Figure 8-37: Types of interlocks for flexo sleeve.
<i>StockType</i> ? New in JDF 1.1 Modified in JDF 1.4	NMTOKEN	<i>@StockType</i> defines the base size when calculating North American or Japanese paper weights. See ▶ Section E Media Weight for details including pre-defined values.
<i>Texture</i> ? New in JDF 1.1 Modified in JDF 1.6	NMTOKEN	The texture of paper media. Values include those from: ▶ <i>Texture</i> .
<i>Thickness</i> ?	double	The thickness of the chosen medium, measured in microns [µm]. Note: Thickness is often referred to as caliper.
<i>UserMediaType</i> ? Deprecated in JDF 1.1	NMTOKEN	A human-readable description of the type of media. The value can be used by an operator to select the correct media to load. The semantics of the values will be site-specific. Deprecation note: Starting with JDF 1.1 , <i>@UserMediaType</i> has been merged into <i>@MediaTypeDetails</i> .
<i>Weight</i> ?	double	Weight of the chosen medium, measured in grams per square meter [g/m ²]. See ▶ Appendix E Media Weight for details on converting anachronistic paper weights to g/m ² .
<i>WrapperWeight</i> ? New in JDF 1.3	double	Weight of the wrapper of a roll, in grams [g].
<i>Certification</i> * New in JDF 1.6	element	<i>Certification</i> SHALL specify a paper certification level that the paper fulfills.
<i>Color</i> ? Deprecated in JDF 1.1	refelement	A <i>Color</i> resource that provides the color of the chosen medium.

Table 8.173: Media Resource (Sheet 6 of 6)

NAME	DATA TYPE	DESCRIPTION
ColorMeasurementConditions ? New in JDF 1.2	reference	Detailed description of the measurement conditions for color measurements used to measure @LabColorValue.
HoleList ? New in JDF 1.3	reference	Explicit list of holes. HoleList SHALL be specified if @HoleType="Explicit".
MediaLayers ? New in JDF 1.3	element	MediaLayers describes the layer structure of media such as corrugated or self adhesive materials.
TabDimensions ? New in JDF 1.4	element	Specifies the dimensions of the tabs when @MediaTypeDetails="TabStock", "PreCutTabs" or "FullCutTabs". Note: See BindingIntent/Tabs (▶ Table 7.35 Tabs Element) (rather than MediaIntent) for how tabbed media is specified in product intent.

Figure 8-35: Paper roll with some roll-specific information

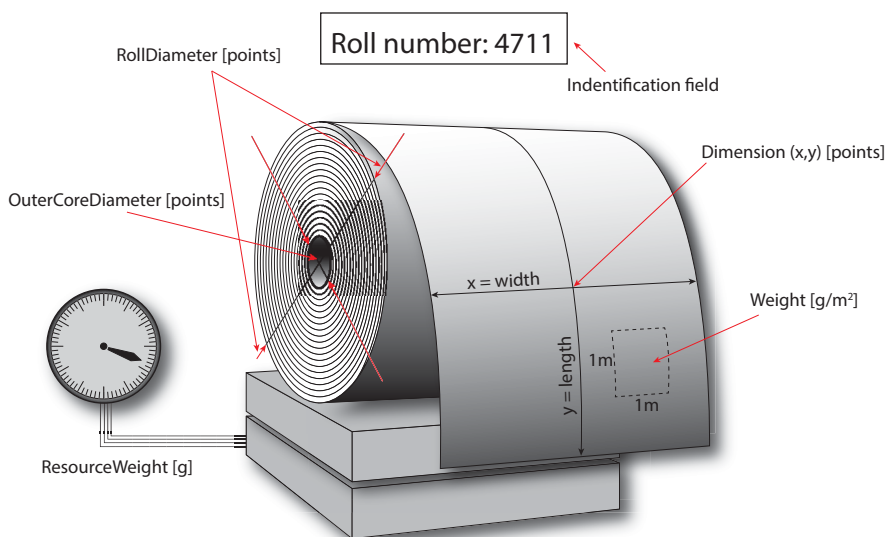

Figure 8-36: Relief and floor thickness for a flexo plate or flexo sleeve

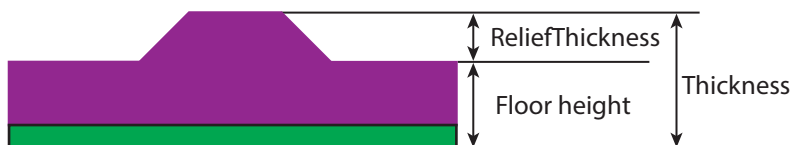
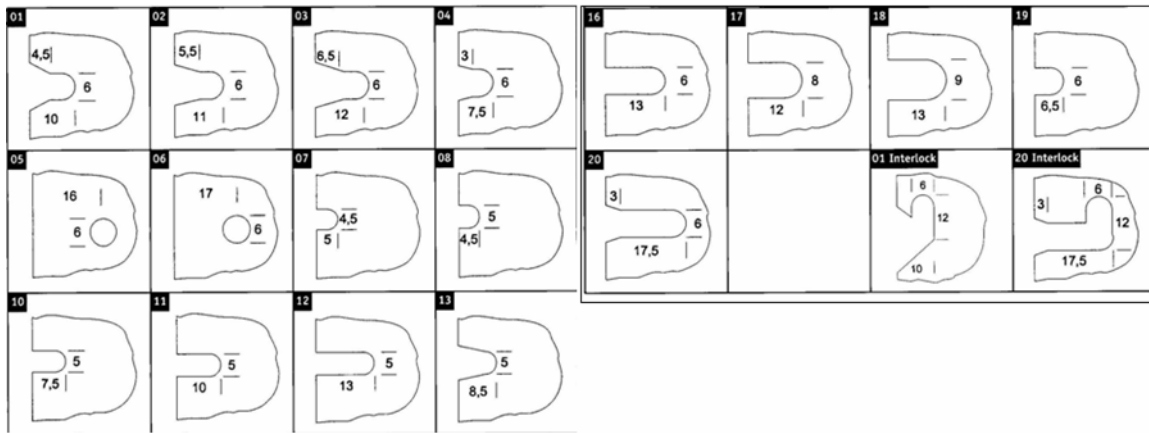

Figure 8-37: Types of interlocks for flexo sleeve^a



a. The dimensions in the figure are specified in mm.

8.91.1 TabDimensions

New in JDF 1.4

Specifies the size and placement of tabs in a bank and in a set of tab stock.

Table 8.174: TabDimensions Element

NAME	DATA TYPE	DESCRIPTION
<i>TabEdge</i> ?	enumeration	Indicates which edge of the media has tabs. Sets the coordinate system for <i>@TabOffset</i> , <i>@TabExtensionDistance</i> , and <i>@TabWidth</i> . Allowed value is : ▶ Edge.
<i>TabExtensionDistance</i> ?	double	The positive distance in points that the tab extends beyond the body of the other media. Note: Same as <i>BindingIntent/Tabs/@TabExtensionDistance</i> . Note: This value is always included in the value of the overall extent of the <i>Media</i> defined by <i>Media/@Dimension</i> . See ▶ Figure 8-38: Diagram of a single bank of tabs.
<i>TabOffset</i> ?	double	Specifies the magnitude of the distance in points from the two corners to the edge of the first “tab pitch” point of the first tab in the bank along the <i>@TabEdge</i> . This distance is the same on both ends of the bank of tabs. See ▶ Figure 8-38: Diagram of a single bank of tabs.
<i>TabSetCollationOrder</i> ?	enumeration	Collation order of media provided in sets. Applicable to sets of pre-cut tabs. See ▶ Figure 8-38: Diagram of a single bank of tabs. Allowed values is from: ▶ Table 8.175 TabSetCollationOrder Attribute Values.
<i>TabsPerBank</i> ?	integer	Specifies the number of equal-sized tabs in a single bank if all positions were filled. Note: Banks can have tabs only in some of the possible positions. Note: Same as <i>BindingIntent/Tabs/@TabsPerBank</i> . <i>Media/@MediaSetCount</i> specifies the number of tabs per set. A set can consist of one or more banks. If <i>Media/@MediaSetCount</i> is not an even multiple of <i>@TabsPerBank</i> , the last bank in each set is partially filled.
<i>TabWidth</i> ?	double	The width along the <i>@TabEdge</i> of each tab as measured along the mid-line of the tab. Each tab is centered within a space called the “tab pitch”. See ▶ Figure 8-38: Diagram of a single bank of tabs.

Table 8.175: TabSetCollationOrder Attribute Values

VALUE	DESCRIPTION	EXAMPLE
Forward	The first tab in reader order SHALL be placed towards the top of the stack.	
Reverse	The first tab in reader order SHALL be placed towards the bottom of the stack.	

Figure 8-38: Diagram of a single bank of tabs



RESOURCES

8.91.2 More about Media

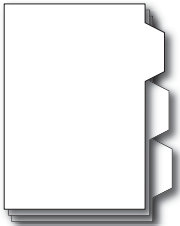
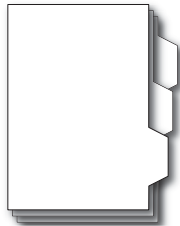
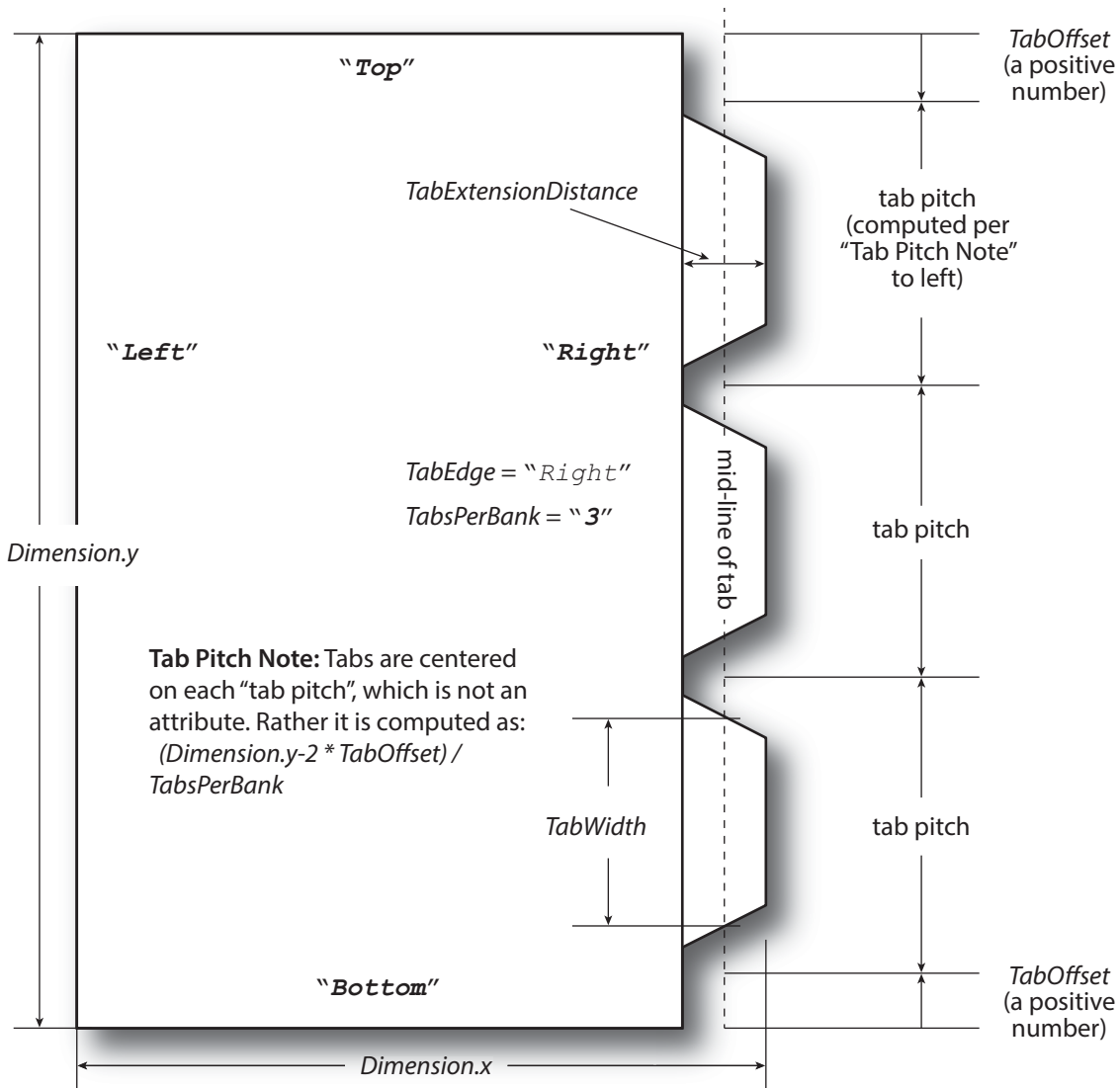
8.91.2.1 Inside Loss and Outside Gain

Inside loss and outside gain: dimensional values used in the mechanical design phase of a box.

Note: IL + OG is not exactly equal to thickness. Thickness is most often referred to as caliper.

Figure 8-39: Inside Loss, Outside Gain

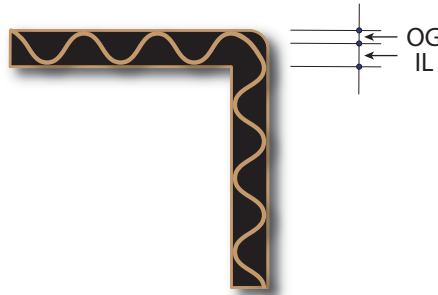

8.91.2.2 Corrugated Media

Corrugated material consists of multiple sheets of paper (called liners) with fluted material in between. For background information on corrugated media, see ▶ [Corrugated Packaging]. Corrugated media comes in different variants.

- Number of layers:
 - single face (1 liner, 1 flute)
 - single wall (2 liners, 1 flute)
 - double wall (3 liners, 2 flutes)
 - triple wall (4 liners, 3 flutes)
- Flute size and frequency: A, B, C, E, F flute. See ▶ [Corrugated Packaging].

Example 8.35: Media: Corrugated

The following example describes single wall corrugated media with two liners and a "B" type flute.

```
<Media Class="Consumable"
  DescriptiveName="B Flute 190Y 180D 1050x1210"
  Dimension="1050.0 120.0" ID="M123456" InsideLoss="1000.0"
  MediaType="CorrugatedBoard" MediaTypeDetails="SingleWall"
  MediaUnit="Sheet" OutsideGain="1380.0"
  ProductID="B190Y180D1050x120" Status="Available"
  Thickness="2382.0" Weight="600">
  <MediaLayers>
    <!-- FrontLiner -->
    <Media DescriptiveName="190gsm clay coated"
      FrontCoatings="Coated" MediaType="Paper" Weight="190"/>
    <!-- Flute -->
    <Media DescriptiveName="Flute" Flute="B"
      FluteDirection="ShortEdge" MediaType="Paper"
      MediaTypeDetails="Flute" Weight="180"/>
    <!-- BackLiner -->
    <Media DescriptiveName="180gsm white top" MediaType="Paper" Weight="180"/>
  </MediaLayers>
</Media>
```

8.91.2.3 Self adhesive Media

Self adhesive media is described as a **MediaLayers** element with nested **Media** and **GlueLine** elements.

Example 8.36: Media: Self Adhesive

The following example describes labels with removable glue on a 60 gram base.

```

<Media Class="Consumable"
  DescriptiveName="40# Fasson coated label stock"
  Dimension="1134.0 0" ID="M123456" MediaType="SelfAdhesive"
  MediaUnit="Roll" ProductID="7890123" Status="Available"
  Thickness="1000.0" Weight="150">
  <MediaLayers>
    <!-- Front -->
    <Media DescriptiveName="Antique Cream Smooth WS IL"
      MediaType="Paper" Weight="90"/>
    <!-- Glue -->
    <GlueLine AreaGlue="true" DescriptiveName="Permanent 91A"
      GlueBrand="Uhu" GlueType="Hotmelt"/>
    <!-- Back -->
    <Media DescriptiveName="Blue Glassine 50" MediaType="Paper" Weight="50"/>
  </MediaLayers>
</Media>

```

8.91.2.4 Flexo Plate Media

A sample of a Flexo plate with dimensions of 900 mm x 1200 mm, a base of 177 microns and a total thickness of 1143 microns.

A raw plate can contain several separations from multiple jobs. The real printing dimensions can only be determined when all elements of the mounting process are known: circumference of the sleeve on which the flat plate will be mounted, thickness of the mounting tape, thickness of base and thickness of the photo-polymer.

Example 8.37: Media: Flexo Plate

```

<Media BatchID="Batch 12345" Brand="BrandB" Class="Consumable"
  DescriptiveName="" Dimension="2551.181 3401.574" ID="M123456"
  Manufacturer="PlateManufacturerA" MediaType="Plate"
  PlateTechnology="FlexoDigitalThermal" ProductID="FlexoPlate"
  ReliefThickness="500" Status="Available" Thickness="1143">
  <!-- MediaLayers contains 2 items: the base layer and the
    photopolymer layer of the flexo plate -->
  <MediaLayers>
    <Media DescriptiveName="Base" MediaType="Plate"
      MediaTypeDetails="FlexoPlateBase" Thickness="177"/>
    <Media DescriptiveName="Photopolymer Layer" MediaType="Plate"
      MediaTypeDetails="FlexoPlatePhotopolymer" Thickness="966"/>
  </MediaLayers>
</Media>

```

8.91.2.5 Flexo Sleeve Media

The Flexo sleeve has dimensions of 500 x 250 mm, a base of 1249 microns and a total thickness of 2810 microns. The sleeve dimensions are identical to the printing dimensions (no distortion).

Example 8.38: Media: Flexo Sleeve

```
<Media BatchID="Batch 6789" Brand="BrandB" Class="Consumable"
  DescriptiveName="Sleeve" Dimension="1417.32 750.0" ID="M123456"
  Manufacturer="PlateManufacturerB" MediaType="Sleeve"
  PlateTechnology="FlexoDigitalSolvent" ProductID="FlexoSleeve"
  ReliefThickness="500" Status="Available" Thickness="2810">
  <!-- MediaLayers contains 2 items: the base layer and the
    photopolymer layer of the flexo plate -->
  <MediaLayers>
    <Media DescriptiveName="Base" MediaType="Plate"
      MediaTypeDetails="FlexoPlateBase" Thickness="1249"/>
    <Media DescriptiveName="Photopolymer Layer" MediaType="Plate"
      MediaTypeDetails="FlexoPhotopolymer" Thickness="1570"/>
  </MediaLayers>
</Media>
```

8.92 MediaSource

Deprecated in JDF 1.1

8.93 MiscConsumable

New in JDF 1.3

The **MiscConsumable** resource is intended for cost accounting, inventory control and availability scheduling of supplies used in the production workflow where a more detailed parameterization of the resource is not necessary.

MiscConsumable SHOULD not be used to describe resources that are already more specifically defined in **JDF** such as **Ink**, **Media**, **Pallet**, **RegisterRibbon**, **Strap** or **UsageCounter**.

MiscConsumable resources MAY appear as inputs to any **JDF** process. The default unit for amounts of **MiscConsumable** is countable objects.

Certain types of **MiscConsumable** elements such as **MiscConsumable**[@ConsumableType="WasteContainer"] are typically “consumed” by being filled. The sense of the @Amount attribute for such resources shall be the quantity of unused or empty waste containers that are available. If @Unit is a volume, distance or weight instead of countable objects, such @Amount will still represent the remaining unused capacity of the waste container.

Resource Properties

Resource Class: Consumable

Input of Processes: Any Process

Table 8.176: MiscConsumable Resource

NAME	DATA TYPE	DESCRIPTION
<i>Color</i> ? New in JDF 1.6	enumeration	@Color specifies the machine readable color of the consumable. Allowed value is from: ▶ NamedColor.
<i>ColorDetails</i> ? New in JDF 1.6	string	@ColorDetails specifies additional details of the color of the consumable that MAY be site specific and MAY be human readable. @Color SHOULD be specified if @ColorDetails is supplied.
<i>ConsumableType</i> ? Modified in JDF 1.5	NMTOKEN	Identifies the type of MiscConsumable (machine-readable). A human-readable (possibly localized) description of the consumable SHOULD also be supplied in @DescriptiveName. Additional machine readable details MAY be provided in @TypeDetails. Values include those from: ▶ Table 8.177 ConsumableType Attribute Values.
<i>TypeDetails</i> ? New in JDF 1.6	NMTOKEN	Additional details of the consumable such as material.

Table 8.177: ConsumableType Attribute Values

VALUE	DESCRIPTION
BackReinforcement	Strip of material that is used to reinforce the spines of a hardcover book. New in JDF 1.6
ChannelBinder	Metal clamp used for channel binding. See ChannelBinding for details.

Table 8.177: ConsumableType Attribute Values

VALUE	DESCRIPTION
Coil	Metal or plastic wire coil used for coil binding. See CoilBinding for details.
Comb	Metal or plastic comb used for comb binding. See PlasticCombBinding or WireCombBinding for details.
Cover	Additional cover used for loose binding. See ChannelBinding , CoilBinding , PlasticCombBinding , RingBinding , StripBinding or WireCombBinding for details.
Developer	Chemicals used in filmsetters and platesetters.
Electricity	Electrical energy. Typically monitored for CO2 tracking. Measured in kWh. New in JDF 1.5
FuserOil	Silicon oil.
Gas	Natural gas. Typically monitored for CO2 tracking. Measured in m ³ . New in JDF 1.5
Glue	Glue is used in many postpress processes.
Grommet	Specifies an eyelet-like shape placed in a hole. New in JDF 1.6
Hardener	Glue hardener used in two component adhesives. New in JDF 1.6
Headband	Head band for a hardcover book. New in JDF 1.4
PaperBand	Paper band, e.g. as used for Wrapping .
Paperclips Deprecated in JDF 1.6	
PaperWrap	Paper wrapper, e.g. as used for Wrapping .
PlasticBand	Plastic band, e.g. as used for Wrapping .
RegistrationRibbon Deprecated in JDF 1.6	Deprecation note: Use RegisterRibbon .
RegisterRibbon	Register ribbons in books. See BlockPreparation for details.
RingBinder	Ring binder used for ring binding. See RingBinding for details.
RubberBand	Rubber band, e.g. as used for Wrapping .
ShrinkWrap	Shrink wrapping material, e.g. as used for Wrapping .
Staples	Prefabricated staples used for Stitching . Use Wire when the staples are not prefabricated.
Strap	Straps are used in a Strapping process. New in JDF 1.6
StripBinder	Strip binder used for strip binding. See StripBinding for details.
Tape	Adhesive tape, e.g. as used for SpineTaping .
Thread	Thread used for ThreadSealing or ThreadSewing . New in JDF 1.6
WasteContainer	Waste container, e.g. for used ink or toner.
Wire	Bulk wire used for forming staples or other bindings.

8.94 NodeInfo

The [NodeInfo](#) resource contains information about planned scheduling and message routing. It allows MIS to plan, schedule and invoice jobs or job parts. Prior to **JDF 1.3**, [NodeInfo](#) was a direct subelement of the **JDF** node and not a resource.

Modification note: Starting with **JDF 1.3**, [NodeInfo](#) is a resource that SHALL be linked (via [NodeInfoLink](#)) like any other resource; there is no “inheritance”. However, a node MAY link to the same [NodeInfo](#) resource as its parent

Note: The NORMATIVE [NodeInfo](#) is specified by a linked resource. An informative [NodeInfo](#) MAY be retrieved by searching the [NodeInfo](#) of parent nodes or [Ancestor](#) elements.

Resource Properties

Resource Class: Parameter

Resource referenced by: [Ancestor](#)

Input of Processes: [Any Process](#)

Table 8.178: NodeInfo Resource (Sheet 1 of 2)

NAME	DATA TYPE	DESCRIPTION
CleanupDuration ?	duration	Estimated duration of the clean-up phase of the process.
DueLevel ?	enumeration	Description of the severity of a missed deadline. Allowed values are: JobCancelled – The job is cancelled if the deadline is missed. Penalty – Missing the deadline incurs a penalty. Trivial – Missing the deadline has minor or no consequences. Unknown – Consequences of missing the deadline are not known. Deprecated in JDF 1.2
End ?	dateTime	Date and time at which the process is scheduled to end.
FirstEnd ?	dateTime	Earliest date and time at which the process SHALL end.
FirstStart ?	dateTime	Earliest date and time at which the process SHALL begin.
IPPVersion ? New in JDF 1.1	XYPair	A pair of numbers (as integers) indicating the version of the IPP protocol to use when communicating to IPP devices. The X value is the major version number.
JobPriority = "50" New in JDF 1.1	integer	The scheduling priority for the node where 100 is the highest and 0 is the lowest. Amongst the nodes that can be processed in the JDF instance, all higher priority nodes are to be processed before any lower priority ones. If one or more of the deadline oriented attributes (e.g., @FirstStart or @LastEnd) is specified, such attribute(s) SHALL be honored before considering @JobPriority . The priority from JDF (QueueSubmissionParams/@Priority or QueueEntryPriParams/@Priority) takes precedence over NodeInfo/@JobPriority . Modification note: Starting with JDF 1.4 , scheduling priority in the first paragraph is described in terms of the node rather than the job
LastEnd ?	dateTime	Latest date and time at which the process SHALL end. This is the deadline to which @DueLevel refers.
LastStart ?	dateTime	Latest date and time at which the process SHALL begin.
MergeTarget ? Deprecated in JDF 1.1	boolean	If @MergeTarget ="true" and this node has been spawned, it SHALL be merged with its direct ancestor by the controller that executes this node. The path of the ancestor is specified in the last Ancestor element located in the AncestorPool of this node. It is an error to specify both @MergeTarget and @TargetRoute in one node. Note: @MergeTarget has been deprecated in JDF 1.1 because avoiding concurrent access to the ancestor node is ill defined and cannot be implemented in an open system without proprietary locking mechanisms.
NaturalLang ? New in JDF 1.6	language	Language selected for human readable communication. If not specified, the operating system's language SHOULD be used.
NodeStatus ? New in JDF 1.3	enumeration	Identifies the status of an individual part of the node. Default value is from: JDF/@Status . Allowed value is from: ▶ Status .
NodeStatusDetails ? New in JDF 1.3	string	Description of the status that provides details beyond the enumerative values given by @NodeStatus . Default value is from: JDF/@StatusDetails . Values include those from: ▶ Status Details .

Table 8.178: NodeInfo Resource (Sheet 2 of 2)

NAME	DATA TYPE	DESCRIPTION
<i>Route</i> ?	URL	The URL of the controller or device that SHALL execute this node. If <i>@Route</i> is not specified, the routing controller SHALL determine a potential target controller or device independently. For details, see ▶ Section 4.2 Process Routing. Note that the receiving device SHALL NOT use <i>@Route</i> to determine whether to execute the node. Rather a device SHALL use a <i>Media</i> input resource (if specified) to determine whether to execute the node.
<i>rRefs</i> ? Deprecated in JDF 1.2	IDREFS	Array of IDs of any elements that are specified as <i>ResourceRef</i> elements. In version 1.1, <i>@rRefs</i> contained the IDREF of an <i>Employee</i> . In JDF 1.2 and beyond, it is up to the implementation to maintain references.
<i>SetupDuration</i> ?	duration	Estimated duration of the setup phase of the process.
<i>Start</i> ?	dateTime	Date and time of the planned process start.
<i>TargetRoute</i> ?	URL	The URL where the JDF SHALL be sent after completion. If <i>@TargetRoute</i> is not specified, it defaults to the input <i>@Route</i> attribute of the subsequent node in the process chain. If this is also not known (e.g., because the node is spawned), the JDF node SHALL be sent to the processor default output URL. If <i>@TargetRoute</i> specifies a file-schemed URL, it SHALL be the exact file name and NOT just the directory of the resulting JDF. <i>JMF/QueueSubmissionParams/@ReturnURL</i> takes precedence over <i>NodeInfo/@TargetRoute</i> of the JDF that is processed.
<i>TotalDuration</i> ?	duration	Estimated total duration of the process, including setup and cleanup.
<i>WorkStepID</i> ? New in JDF 1.4	string	ID of an individual work step (e.g., a Press Run). If <i>NodeInfo</i> is not partitioned, or all partitions are executed simultaneously, <i>@WorkStepID</i> corresponds to <i>@JobPartID</i> .
<i>BusinessInfo</i> ? Deprecated in JDF 1.6	element	Container for business related information. It is expected that JDF will be utilized in conjunction with other e-commerce standards, and this container is provided to store the e-commerce information within JDF in case a workflow with JDF as the root level document is desired. When JDF is used as part of an e-commerce solution such as PrintTalk, the information given in the envelope document overrides the information in <i>BusinessInfo</i> .
<i>Employee</i> ?	refelement	The internal administrator or supervisor that is responsible for the product or process defined in this node.
<i>GangSource</i> * New in JDF 1.6	element	If present, each <i>GangSource</i> SHALL represent the source jobs that are being processed as a gang job.
<i>JMF</i> * Deprecated in JDF 1.5	element	Represents <i>JMF</i> query messages that set up a persistent channel, as described in ▶ Section 5.3.4 Persistent Channels. These message elements define the receiver that is designated to track jobs via <i>JMF</i> messages. These message elements SHOULD be honored by any <i>JMF</i> capable controller or device that executes this node. When these messages are honored, a persistent communication channel is established that allows devices to transmit (e.g., the status of the job as <i>JMF Signal</i> messages). The <i>JMF</i> specified in this <i>NodeInfo</i> SHALL be restricted in scope to the containing JDF element. Typically this will be achieved by explicitly stating <i>@JobID</i> in the appropriate <i>QueryTypeObj</i> . Deprecation note: Starting with JDF 1.5, subscriptions SHOULD only be specified as root <i>JMF</i> .
<i>MISDetails</i> ? New in JDF 1.2	element	Definition how the costs for the execution of this node SHALL be charged.
<i>NotificationFilter</i> * Deprecated in JDF 1.6	element	Defines the set of <i>NotificationFilter</i> elements that are to be logged in the <i>AuditPool</i> . This provides a logging method for devices that do not support <i>JMF</i> messaging. For details of the <i>NotificationFilter</i> element, see ▶ Section 5.34.1 NotificationFilter.

8.95 NumberingParams

Deprecated in JDF 1.5

8.96 OrderingParams

Deprecated in JDF 1.5

8.97 PackingParams

Deprecated in JDF 1.1

The **PackingParams** resource has been deprecated in **JDF 1.1** and beyond. It is replaced by the individual resources used by the processes defined in ▶ Section 6.6.5 Packaging Processes.

8.98 PageAssignParams

New in JDF 1.4

PageAssignParams is an empty container for future extensions

Resource Properties

Resource Class: Parameter

Input of Processes: PageAssigning

Table 8.179: PageAssignParams Resource

NAME	DATA TYPE	DESCRIPTION

8.99 PageList

New in JDF 1.2

PageList defines the additional metadata of individual finished pages such as pagination details. **PageList** references the finished page regardless of the page’s position in a PDL file or **RunList**.

Resource Properties

Resource Class: Parameter

Resource referenced by: Assembly, Component, ExposedMedia, LayoutElement, RunList

Example Partition: "PartVersion"

Table 8.180: PageList Resource (Sheet 1 of 2)

NAME	DATA TYPE	DESCRIPTION
<i>AssemblyID</i> ? Deprecated in JDF 1.3	string	ID of the Assembly or AssemblySection that this finished page belongs to.
<i>AssemblyIDs</i> ? New in JDF 1.3	NMTOKENS	IDs of the Assembly elements, AssemblySection elements or StrippingParams [@BinderySignatureName] that the finished pages specified by this PageList belong to.
<i>HasBleeds</i> ?	boolean	If "true", the file has bleeds.
<i>IsBlank</i> ?	boolean	If "true", the PageList has no content marks and is blank. Note that in JDF 1.2 , the description erroneously stated that @IsBlank="false" specifies a blank page.
<i>IsPrintable</i> ?	boolean	If "true", the file is a PDL file and can be printed. Possible files types include PCL, PDF or PostScript files. Application files such as MS Word have @IsPrintable="false".
<i>IsTrapped</i> ?	boolean	If "true", the file has been trapped.
<i>JobID</i> ?	string	ID of the job that this finished page belongs to.
<i>PageLabelPrefix</i> ?	string	Prefix of the identification of the reader page as it is displayed on the finished page. For instance "C-", if the reader pages are labeled "C-1", "C-2", etc.

Table 8.180: PageList Resource (Sheet 2 of 2)

NAME	DATA TYPE	DESCRIPTION
PageLabelSuffix ?	string	Suffix of the identification of the reader page as it is displayed on the finished page. For instance "-a", if the pages are labeled "C-1-a", "C-2-a", etc.
SourceBleedBox ?	rectangle	A rectangle that describes the bleed area of the page to be included. This rectangle is expressed in the source coordinate system of the object. If not specified, use defined bleed box of element (or no bleed box if element does not supply a bleed box).
SourceClipBox ?	rectangle	A rectangle that defines the region of the finished page to be included. This rectangle is expressed in the source coordinate system of the object. If not specified, use defined clip box of element (or no clip box if element does not supply a clip box).
SourceTrimBox ?	rectangle	A rectangle that describes the intended trimmed size of the finished page to be included. This rectangle is expressed in the source coordinate system of the object. If not specified, use defined trim box of element (or no trim box if element does not supply a trim box).
Template="false"	boolean	Template is "false" when this page is self-contained. This attribute is "true" if the PageList represents a template that SHALL be completed with information from a database.
Assembly ? New in JDF 1.3	reference	Assembly that is referred to by @AssemblyIDs or contains the AssemblySection that is referred to by @AssemblyIDs .
ColorPool ?	reference	Definition of the color details.
ContentList ? New in JDF 1.3	reference	List of ContentData elements that describe individual pieces of content on the pages.
ElementColorParameters ?	reference	Color details of the page list.
ImageCompressionParameters ?	reference	Specification of the image compression properties.
PageData *	element	Details of the individual finished page. The PageData elements are referred to by the values of PageData/@PageIndex (if present), or otherwise, their index in the PageList . In the latter case, the PageData elements SHOULD, therefore, not be removed or inserted in a position other than the end of the list. Modification note: See the Modification note in the section on the PageData element below.
ScreeningParams ?	reference	Specification of the screening properties.
SeparationSpec *	element	List of separation names defined in the PageList .

8.99.1 PageData

[PageData](#) defines the additional metadata of individual finished pages or sets of finished pages with common properties, such as pagination details.

If [@PageIndex](#) is not present in [PageData](#) elements, [PageData](#) elements are referred to by index of the [PageData](#) in the [PageList](#). If [@PageIndex](#) is present, it explicitly specifies the indices within the [PageList](#). Either all or no [PageData](#) elements in a [PageList](#) SHALL have [@PageIndex](#). If a page is not represented by a [PageData](#), the attributes of the [PageList](#) itself apply.

Modification note: Starting with JDF 1.4, [PageData/@PageIndex](#) is added. It allows [PageData](#) to describe multiple finished pages and to explicitly specify the index of a [PageData](#) element within a [PageList](#). The explicit index allows a [PageList](#) to contain a [PageData](#) for a particular index (e.g., 100) without the need for [PageData](#) elements for all indices that are lower (e.g., 0 to 99). Without [@PageIndex](#), the position of [PageData](#) within [PageList](#) implicitly specifies its index. If the [PageList](#) is partitioned, the index refers to [PageData](#) elements in the respective leaves of the partitioned [PageList](#). The index restarts at 0 with each partitioned leaf.

Table 8.181: PageData Element (Sheet 1 of 2)

NAME	DATA TYPE	DESCRIPTION
AssemblyID ? Deprecated in JDF 1.3	string	ID of the Assembly or AssemblySection that this finished page belongs to. Default value is from: PageList / @AssemblyID .
AssemblyIDs ? New in JDF 1.3	NMTOKENS	IDs of the Assembly elements, AssemblySection elements or StrippingParams [@BinderySignatureName] that this finished page belongs to. Default value is from: PageList / @AssemblyIDs .
CatalogID ?	string	Identification of the resource (e.g., in a catalog environment). Default value is from: PageList / @CatalogID .
CatalogDetails ?	string	Additional details of a resource in a catalog environment. Default value is from: PageList / @CatalogDetails .
FoldOutPages ?	IntegerList	Page indices in the PageList of the file pages forming a content page that flows over multiple finished pages (e.g., foldout, centerfold). The list does not include the index of this PageData . Default behavior: PageData does not describe a part of a foldout.
HasBleeds ?	boolean	If "true", the file has bleeds. Default value is from: PageList / @HasBleeds .
IsBlank ?	boolean	If "true", the PageData has no content marks and is blank. Note that in JDF 1.2 the description erroneously stated that @IsBlank ="false" specifies a blank page. Default value is from: PageList / @IsBlank .
IsPrintable ?	boolean	If "true", the file is a PDL file and can be printed. Possible files types include PCL, PDF or PostScript files. Application files such as MS Word have @IsPrintable ="false". Default value is from: PageList / @IsPrintable .
IsTrapped ?	boolean	If "true", the file has been trapped. Default value is from: PageList / @IsTrapped .
JobID ?	string	ID of the job that this finished page belongs to. Default value is from: PageList / @JobID .
PageFormat ? New in JDF 1.3	NMTOKEN	Defines the format of the page in a production workflow. Values include: Broadsheet – One single page that will be mounted on a broadsheet plate (one page goes on one (broadsheet) plate). Tabloid – One single page that will be paired with a second tabloid page. Later, the page pair will be mounted on a broadsheet plate. Newspaper4up – Four pages will be mounted on one plate. Newspaper8up – Eight pages will be mounted on one plate. Note: The values are for a newspaper workflow.
PageIndex ? New in JDF 1.4	IntegerRangeList	List of pages the PageData element represents. A page number SHALL NOT appear more than once in the PageList .
PageLabel ?	string	Complete identification of the finished page including @PageLabelPrefix and @PageLabelSuffix as it is displayed on the finished page, For instance "1", "iv" or "C-1". Note that this might be different from the position of the page in the finished document.
PageLabelPrefix ?	string	Prefix of the identification of the reader page as it is displayed on the finished page. For instance "C-", if the reader pages are labeled "C-1", "C-2", etc. Default value is from: PageList / @PageLabelPrefix .
PageLabelSuffix ?	string	Suffix of the identification of the reader page as it is displayed on the finished page. For instance "-a", if the pages are labeled "C-1-a", "C-2-a", etc. Default value is from: PageList / @PageLabelSuffix .

Table 8.181: PageData Element (Sheet 2 of 2)

NAME	DATA TYPE	DESCRIPTION
<i>PageStatus</i> ? New in JDF 1.3	NMTOKENS	Status of a single <i>PageData</i> element. Values include those from: ▶ Milestones.
<i>ProductID</i> ?	string	An ID of the page as defined in the MIS system. Default value is from: <i>PageList</i> / <i>@ProductID</i> .
<i>SourceBleedBox</i> ?	rectangle	A rectangle that describes the bleed area of the page to be included. This rectangle is expressed in the source coordinate system of the object. Default value is from: <i>PageList</i> / <i>@SourceBleedBox</i> .
<i>SourceClipBox</i> ?	rectangle	A rectangle that defines the region of the finished page to be included. This rectangle is expressed in the source coordinate system of the object. Default value is from: <i>PageList</i> / <i>@SourceClipBox</i> .
<i>SourceTrimBox</i> ?	rectangle	A rectangle that describes the intended trimmed size of the finished page to be included. This rectangle is expressed in the source coordinate system of the object. Default value is from: <i>PageList</i> / <i>@SourceTrimBox</i> .
<i>Template</i> ?	boolean	Template is "false" when this page is self-contained. This attribute is "true" if the <i>PageList</i> represents a template that SHALL be completed with information from a database. Default value is from: <i>PageList</i> / <i>@Template</i> .
<i>ElementColorParams</i> ?	refelement	Color details of the <i>PageData</i> element. Default value is from: <i>PageList</i> / <i>ElementColorParams</i>
<i>ImageCompressionParams</i> ?	refelement	Specification of the image compression properties. Default value is from: <i>PageList</i> / <i>ImageCompressionParams</i>
<i>OCGControl</i> * New in JDF 1.6	element	<i>OCGControl</i> provides a list of the OCGs (layers) that SHALL be included or excluded. Any OCGs (layers) not listed in an <i>OCGControl</i> element SHALL follow the rules defined by the underlying PDL.
<i>PageElement</i> * New in JDF 1.3	element	Describes an individual element on a page. This might be a part of an image, text, advertisement, editorial, etc.
<i>ScreeningParams</i> ?	refelement	Specification of the screening properties. Default value is from: <i>PageList</i> / <i>ScreeningParams</i>
<i>SeparationSpec</i> *	element	List of separation names defined in the element. Default value is from: <i>PageList</i> / <i>SeparationSpec</i>

8.99.2 PageElement

New in JDF 1.3

PageElement defines the positioning of *ContentData* on a page or *PageElement* and additional metadata of individual elements within a page.

Table 8.182: PageElement Element (Sheet 1 of 2)

NAME	DATA TYPE	DESCRIPTION
<i>ContentDataRefs</i> ? New in JDF 1.4	IDREFS	<i>ContentData</i> provides metadata of the element that is independent of the page position. ID of the <i>ContentData</i> elements in the referenced <i>ContentList</i> . <i>ContentData</i> elements provide metadata related to this <i>PageData</i> . <i>@ContentDataRefs</i> SHALL NOT be specified if no <i>ContentData</i> is specified in the grand-parent <i>PageList</i> element.
<i>ContentListIndex</i> ? Deprecated in JDF 1.4	integer	Index into a <i>ContentList</i> / <i>ContentData</i> element. If neither <i>@ContentListIndex</i> nor <i>PageElement</i> are specified, this <i>PageElement</i> is a reservation. Deprecation note: Starting with JDF 1.4, use <i>@ContentDataRefs</i> .

Table 8.182: PageElement Element (Sheet 2 of 2)

NAME	DATA TYPE	DESCRIPTION
<i>ContentType</i> ?	NMTOKEN	Type of content that is placed in this PageElement . Values include those from: ▶ Content Types.
<i>ElementPages</i> ?	IntegerRangeList	List of pages that this PageElement traverses. Multiple values designate, e.g., fold out pages or multi-page ads.
<i>RelativeBox</i> ?	Rectangle	Position of the PageElement in the coordinate system of the parent PageData .
PageElement *	element	Further sub-page elements that comprise this PageElement .

8.100 Pallet

New in JDF 1.1

A **Pallet** represents the pallet used in packing goods.

Resource Properties

Resource Class: Consumable

Input of Processes: **Palletizing**

Table 8.183: Pallet Resource

NAME	DATA TYPE	DESCRIPTION
<i>PalletType</i> Modified in JDF 1.4	NMTOKEN	Type of pallet used. Values include those from: ▶ Pallet Types.
<i>Size</i> ?	XYPair	Describes the length and width of the pallet, in points (e.g., 3500 3500). If not specified, the size is defined by @ <i>PalletType</i> .

8.101 PalletizingParams

New in JDF 1.1

PalletizingParams defines the details of **Palletizing**. Details of the actual pallet used for **Palletizing** can be found in the **Pallet** resource that is also an input of the **Palletizing** process.

Resource Properties

Resource Class: Parameter

Intent Pairing: **PackingIntent**

Input of Processes: **Palletizing**

Table 8.184: PalletizingParams Resource

NAME	DATA TYPE	DESCRIPTION
<i>LayerAmount</i> ? New in JDF 1.4	IntegerList	Ordered number of input components in a layer. The first number is the first layer on the bottom. If there are more layers than entries in the list, counting restarts at the first entry.
<i>MaxHeight</i> ?	double	Maximum height of a loaded pallet in points.
<i>MaxWeight</i> ?	double	Maximum weight of a loaded pallet in grams.
<i>Overhang</i> ? New in JDF 1.4	XYPair	Overhang in <i>x</i> and <i>y</i> direction on each side.
<i>OverhangOffset</i> ? New in JDF 1.4	XYPair	Overhang offset if overhang is not centered.
<i>Pattern</i> ?	string	Name of the palletizing pattern. Used to store a predefined pattern that defines the layers and positioning of individual component on the pallet.
Bundle ? New in JDF 1.4	refelement	Describes additional properties, such as the number of individual products, and describes the list of the individual products on the pallet.

8.102 PDFToPSConversionParams

PDFToPSConversionParams specifies a set of configurable options that can be used by processes that read PDF and generate PostScript files. It is RECOMMENDED to describe reading of arbitrary PDL documents as a combination of the **Interpreting** and **PDLCreation** processes.

Some descriptions below mention attributes or structures in specific source formats, such as PDF. Appropriate equivalent actions should be taken when converting from other source formats that have equivalent attributes or structures. A small number of parameters apply only to PDF sources.

Font controls are applied in the following order:

- 1 @IncludeBaseFonts
- 2 @IncludeEmbeddedFonts
- 3 @IncludeType1Fonts
- 4 @IncludeType3Fonts
- 5 @IncludeTrueTypeFonts
- 6 @IncludeCIDFonts

For example, an embedded Type-1 font follows the rule for embedded fonts, not the rule for Type-1 fonts. In other words, if @IncludeEmbeddedFonts is "true", and @IncludeType1Fonts is "false", embedded Type-1 fonts would be included in the PostScript stream.

Resource Properties

Resource Class: Parameter

Resources referenced: **PDLCreationParams**

Example Partition: "DocIndex", "RunIndex", "RunTags", "DocTags", "PageTags", "SetTags", "SheetName", "Side", "SignatureName"

Input of Processes: **PDFToPSConversion**

Table 8.185: PDFToPSConversionParams Resource (Sheet 1 of 3)

NAME	DATA TYPE	DESCRIPTION
BinaryOK="true"	boolean	If "false", binary data SHALL NOT be included in the PostScript stream.
BoundingBox ?	rectangle	@BoundingBox is used for BoundingBox DSC comment in @CenterCropBox calculations and for PostScript's setpagedevice .
CenterCropBox="true"	boolean	If "true", the CropBox from the source document SHALL be centered on the page when the CropBox is smaller than MediaBox .
GeneratePageStreams="false"	boolean	If "true", the process SHALL emit individual streams of data for each page in the RunList .
IgnoreAnnotForms="false"	boolean	If "true", annotations that contain a PDF XObject form SHALL be ignored. (PDF source only).
IgnoreBG = "true" New in JDF 1.1	boolean	If "true", the BG , BG2 parameters in the PDF ExtGState dictionary, and the operand of any calls to the PostScript setblackgeneration operator SHALL be ignored.
IgnoreColorSeps="false"	boolean	If "true", images for Level-1 separations SHALL be ignored.
IgnoreDeviceExtGState ? Deprecated in JDF 1.1	boolean	If "true", all device-dependent extended graphic state parameters SHALL be ignored. This overrides @IgnoreHalftones. The following parameters are to be ignored. OP – Overprint parameter. OPM – Overprint mode. BG , BG2 – Black generation. UCR , UCR2 – Undercolor removal. TR , TR2 – Transfer functions. HT – Halftone dictionary. FL – Flatness tolerance. SA – Automatic stroke adjustment.
IgnoreDSC="true"	boolean	If "true", DSC (Document Structuring Conventions) SHALL be ignored.

Table 8.185: PDFToPSConversionParams Resource (Sheet 2 of 3)

NAME	DATA TYPE	DESCRIPTION
<i>IgnoreExternStreamRef</i> ="false"	boolean	If a PDF image resource uses an external stream and <i>@IgnoreExternStreamRef</i> ="true", code that points to the external file SHALL be ignored. (PDF source only). Note: <i>@IgnoreExternStreamRef</i> was misspelled as <i>@IgnoreExternSreamRef</i> prior to JDF 1.3.
<i>IgnoreHalftones</i> ="false"	boolean	If "true", any halftone screening in the source file SHALL be ignored.
<i>IgnoreOverprint</i> ="true" New in JDF 1.1	boolean	If "true", OP parameters in a source PDF ExtGState dictionary and setoverprint in a source PostScript file, etc. SHALL be ignored.
<i>IgnorePageRotation</i> ="false"	boolean	If "true", a "concatenation" provided at the beginning of each page that orients the page so that it is properly rotated SHALL be ignored. Used when emitting EPS.
<i>IgnoreRawData</i> ="false"	boolean	If "true", no unnecessary filters SHALL be added when emitting image data.
<i>IgnoreSeparableImagesOnly</i> ="false"	boolean	If "true", and if emitting EPS, only CMYK and gray images SHALL be ignored.
<i>IgnoreShowPage</i> ="false"	boolean	If "true", save-and-restore showpage in PostScript files SHALL be ignored.
<i>IgnoreTransfers</i> ="true" New in JDF 1.1	boolean	If "true", TR , TR2 parameters in a source PDF ExtGState dictionary, settransfer and setcolortransfer in a source PostScript file, etc. SHALL be ignored.
<i>IgnoreTTFontsFirst</i> ="false"	boolean	If "true", TrueType fonts SHALL be ignored before any other fonts.
<i>IgnoreUCR</i> ="true" New in JDF 1.1	boolean	If "true", UCR , UCR2 parameters in a source PDF ExtGState dictionary, setundercolorremoval in a source PostScript file, etc. SHALL be ignored.
<i>IncludeBaseFonts</i> ="IncludeNever"	enumeration	Determines when to embed the base fonts. The base fonts are "Symbol" and the plain, bold, italic and bold-italic faces of "Courier", "Times", and "Helvetica". Allowed value is from: ▶ IncludeResources.
<i>IncludeCIDFonts</i> ="IncludeOncePerDoc"	enumeration	Determines when to embed CID fonts. Allowed value is from: ▶ IncludeResources.
<i>IncludeEmbeddedFonts</i> ="IncludeOncePerDoc"	enumeration	Determines when to embed fonts in the document that are embedded in the source file. This attribute overrides the <i>@IncludeType1Fonts</i> , <i>@IncludeTrueTypeFonts</i> and <i>@IncludeCIDFonts</i> attributes. Allowed value is from: ▶ IncludeResources.
<i>IncludeOtherResources</i> ="IncludeOncePerDoc"	enumeration	Determines when to include all other types of resources in the file. Allowed value is from: ▶ IncludeResources.
<i>IncludeProcSets</i> ="IncludeOncePerDoc"	enumeration	Determines when to include ProcSets in the file. Allowed value is from: ▶ IncludeResources.
<i>IncludeTrueTypeFonts</i> ="IncludeOncePerDoc"	enumeration	Determines when to embed TrueType fonts. Allowed value is from: ▶ IncludeResources.
<i>IncludeType1Fonts</i> ="IncludeOncePerDoc"	enumeration	Determines when to embed Type-1 fonts. Allowed value is from: ▶ IncludeResources.

Table 8.185: PDFToPSConversionParams Resource (Sheet 3 of 3)

NAME	DATA TYPE	DESCRIPTION
<code>IncludeType3Fonts="IncludeOncePerPage"</code>	enumeration	Determines when to embed Type-3 fonts. It is included here to complete the precedence hierarchy. It has only one value. Allowed values are: <code>"IncludeOncePerPage"</code>
<code>OutputType="PostScript"</code>	enumeration	Describes the kind of output to be generated. Allowed values are: <code>PostScript</code> <code>EPS</code>
<code>PSLevel="2"</code>	integer	Number that indicates the PostScript level. Values include <code>"1"</code> , <code>"2"</code> or <code>"3"</code> .
<code>Scale="100"</code>	double	Number that indicates the wide-scale factor of documents. Full size= <code>"100"</code> .
<code>SetPageSize="false"</code>	boolean	If <code>"true"</code> , sets page size on each page automatically. For PDF source, use MediaBox for outputting PostScript files and CropBox for EPS. This applies for PostScript Levels 2 and 3 only.
<code>SetupProcsets="true"</code>	boolean	If <code>"true"</code> , indicates that if ProcSets are included, the init/term code SHALL also be included.
<code>ShrinkToFit="false"</code>	boolean	If <code>"true"</code> , the page SHALL be scaled to fit the printer page size. This field SHALL override scale.
<code>SuppressCenter="false"</code>	boolean	If <code>"true"</code> , page contents whose crop box is smaller than the page size SHALL NOT be automatically centered.
<code>SuppressRotate="false"</code>	boolean	If <code>"true"</code> , pages with dimensions that are better suited to landscape orientation SHALL NOT be automatically rotated. More specifically, the application that generates the PostScript compares the dimensions of the page. If the width is greater than the height, then pages are SHALL NOT be rotated if <code>@SuppressRotate="true"</code> . On the other hand, if <code>@SuppressRotate="false"</code> , the orientation of each source page (e.g., as set by the PDF Rotate key) is honored, regardless of the dimensions of the pages (as defined by the MediaBox attribute).
<code>TTasT42="false"</code>	boolean	If <code>"true"</code> , and if including TrueType fonts, the fonts SHALL be converted to Type-42 instead of Type-1.
<code>UseFontAliasNames="false"</code>	boolean	If <code>"true"</code> , font alias names SHALL be used when printing with system fonts.

8.103 PDLCreationParams

New in JDF 1.3

PDLCreationParams is used to encapsulate the PDL output parameters for the supported output PDL types used in the **PDLCreation** process.

Resource Properties

Resource Class: **Parameter**

Input of Processes: **PDLCreation**

Table 8.186: PDLCreationParams Resource (Sheet 1 of 2)

NAME	DATA TYPE	DESCRIPTION
<code>MimeType</code>	string	This resource identifies the MIME type associated with this output file format. For example <code>"application/pdf"</code> . IANA maintains a registry of MIME types, see ▶ [IANA-mt].
<code>FontParams</code> ? New in JDF 1.6	reference	FontParams describes how fonts SHALL be handled when creating PDL.
<code>PDFToPSConversionParams</code> ?	reference	Postscript specific Parameter Resource for the output. It SHALL NOT be specified unless <code>@MimeType="application/postscript"</code> .

Table 8.186: PDLCreationParams Resource (Sheet 2 of 2)

NAME	DATA TYPE	DESCRIPTION
PSToPDFConversionParams ?	reference	PDF specific Parameter Resource for the output. It SHALL NOT be specified unless <code>@MimeType="application/pdf"</code> .

8.104 PDLResourceAlias

[PDLResourceAlias](#) provides a mechanism for referencing resources that occur in files, or that are expected to be provided by devices. Prepress and printing processes have traditionally used the word “Resource” to refer to reusable data structures that are needed to perform processes. Examples of such resources include fonts, halftones and functions. The formats of these resources are defined within PDLs, and instances of these resources can occur within PDL files or can be provided by devices.

JDF does not provide a syntax for defining such resources directly within a job. Instead, resources continue to occur within PDL files and continue to be provided by devices. However, since it is necessary to be able to refer to these resources from JDF jobs, the [PDLResourceAlias](#) resource is provided to fulfill this need.

Resource Properties

Resource Class: **Parameter**
 Resource referenced by: [ColorantControl/ColorSpaceSubstitute](#)
 Input of Processes: **Interpreting**

Table 8.187: PDLResourceAlias Resource

NAME	DATA TYPE	DESCRIPTION
ResourceType	string	The type of PDL resource that is referenced. The semantic of this attribute is defined by the PDL.
SourceName ?	string	The name of the resource in the file referenced by the FileSpec or by the device.
FileSpec ?	reference	Location of the file containing the PDL resource. If FileSpec is absent, the device is expected to provide the resource defined by this PDLResourceAlias resource.

8.105 PerforatingParams

New in JDF 1.1

[PerforatingParams](#) define the parameters for perforating a sheet.

Resource Properties

Resource Class: **Parameter**
 Intent Pairing: [FoldingIntent](#)
 Input of Processes: **Perforating**

Table 8.188: PerforatingParams Resource

NAME	DATA TYPE	DESCRIPTION
Perforate *	element	Defines one or more Perforate lines.

8.106 PlaceholderResource

Deprecated in JDF 1.5

8.107 PlasticCombBindingParams

[PlasticCombBindingParams](#) describes the details of the [PlasticCombBinding](#) process.

Resource Properties

Resource Class: **Parameter**

Intent Pairing: [BindingIntent](#)
 Input of Processes: [PlasticCombBinding](#)

Table 8.189: PlasticCombBindingParams Resource

NAME	DATA TYPE	DESCRIPTION
Brand ?	string	The name of the comb manufacturer and the name of the specific item.
Color ?	enumeration	Determines the color of the plastic comb. Allowed value is from: ▶ NamedColor.
ColorDetails ? New in JDF 1.4	string	A more specific, specialized or site-defined name for the color. If @ColorDetails is supplied, @Color SHOULD also be supplied.
Diameter ?	double	The comb diameter is determined by the height of the block of sheets to be bound.
Thickness ?	double	The material thickness of the comb.
Type ? Modified in JDF 1.1 Deprecated in JDF 1.2	enumeration	The distance between the “teeth” and the distance between the holes of the pre-punched sheets SHALL be the same. The following values from the hole type catalog in ▶ Appendix K Hole Pattern Catalog exist: Allowed values are: P12m-rect-02 – Distance = 12 mm; Holes = 7 mm x 3 mm P16-9i-rect-0t – Distance = 14.28 mm; Holes = 8 mm x 3 mm Euro – (Distance = 12 mm; Holes = 7 mm x 3 mm) Deprecated in JDF 1.1. USA1 – (Distance = 14.28 mm; Holes = 8 mm x 3 mm) Deprecated in JDF 1.1. Deprecation note: Starting with JDF 1.2 , use the value implied by HoleMakingParams / @HoleType .
HoleMakingParams ?	refelement	Details of the holes to be made. Note that HoleMakingParams / @Shape is always rectangular by design of the plastic combs.

8.108 PlateCopyParams

Deprecated in JDF 1.1

8.109 PreflightAnalysis

Deprecated in JDF 1.2

[PreflightAnalysis](#) was deprecated as a result of a major revision to the [Preflight](#) process and its associated resources.

8.110 PreflightInventory

Deprecated in JDF 1.2

[PreflightInventory](#) was deprecated as a result of a major revision to the [Preflight](#) process and its associated resources.

8.111 PreflightParams

New in JDF 1.2

The [PreflightParams](#) resource specifies the tests for the [Preflight](#) process to run. These tests are defined using ▶ Section 10.2.2 ActionPool, which defines a list of reporting actions to have for given document object tests defined into a [Test](#). (See ▶ Section 10.2.12 TestPool). This section makes use of elements and attributes defined in ▶ Section 10 Device Capabilities. It is suggested that readers familiarize themselves with that section and ▶ Section 10.3 Concept of the Preflight Process.

Resource Properties

Resource Class: Parameter

Resource referenced by: [PreflightReport](#)

Input of Processes: **Preflight**

Table 8.190: PreflightParams Resource

NAME	DATA TYPE	DESCRIPTION
ActionPool * Modified in JDF 1.4	element	A set of ActionPool elements. Multiple ActionPool elements are equivalent to one ActionPool that contains all Action elements of the individual ActionPool elements. ActionPool and TestPool SHALL both be supplied or both be absent. Modification note: Starting with JDF 1.4 , ActionPool becomes optional.
FileSpec ? New in JDF 1.4	refelement	File that describes the preflight actions in a non JDF format.
TestPool ? New in JDF 1.3 Modified in JDF 1.4	element	Container for zero or more Test elements that are referenced from Action elements in the ActionPool . ActionPool and TestPool SHALL both be supplied or both be absent. Modification note: Starting with JDF 1.4 , TestPool becomes optional. It was REQUIRED when it was added in JDF 1.3 because ActionPool implicitly requires a parallel TestPool as a container for the referenced Test elements that are defined in Action/@TestRef .

The **ActionPool**, as defined in ▶ Section 10.2.2 ActionPool, has **Action** subelements, which can reference a **Test** with a given action type. The **Action** element includes a **PreflightAction** subelement, defined below, which can be used to define how tests are to be applied in **Preflight** processes.

8.111.1 PreflightAction

Table 8.191: PreflightAction Element

NAME	DATA TYPE	DESCRIPTION
SetRef ?	IDREF	A reference to a preflight Test ID used to filter a set of objects before applying the tests referenced by preflight Action . When @SetRef is not defined, the Test is applied to all the objects.
SetSplitBy = "RunList"	enumeration	This is used to group objects in different ways. Allowed values are: Page – Tests are applied on objects page per page. Document – Tests are applied on objects document per document. RunList – All objects of all pages included in all documents are processed together. Note: @SetSplitBy is only used when @SetRef is defined in order to create sets on a page-per-page or document-per-document basis. For instance, if you want to get the list of separations per page, @SetSplitBy is set to "Page". In such a case, the report's content (as long as the @PRIItem is defined properly for the Action) will be grouped by page.

Test elements make use of **Evaluation** subelements that define various basic preflight testing functions that can be combined together in order to build preflight test. In order to specify basic preflight tests using **Evaluation**, the subelement **BasicPreflightTest** is used.

Note: The **BasicPreflightTest** includes a **PreflightArgument** subelement that is defined below.

8.111.2 BasicPreflightTest

The **BasicPreflightTest** element defines a named preflight test that can be evaluated by a preflight application. The result of the test can be compared with the values defined in the explicit **Evaluation** elements in order to filter the objects within the file to be tested. The following table describes the **BasicPreflightTest** element.

Table 8.192: BasicPreflightTest Element (Sheet 1 of 2)

NAME	DATA TYPE	DESCRIPTION
Classes ? New in JDF 1.4	NMTOKENS	List of object classes that the test SHALL be applied to. It is strongly recommended to supply @Classes .

Table 8.192: BasicPreflightTest Element (Sheet 2 of 2)

NAME	DATA TYPE	DESCRIPTION
<i>ClassName</i> ? New in JDF 1.4	NMTOKEN	This tag can be used to directly command the test to specifically apply to a given class of object. The two purposes of this change are 1) to simply preflight engine processors, and 2) to simplify test rules. Allowed values are from: ▶ Table 10.69 Object Classes for a Document.
<i>DevNS</i> ?= "http://www.CIP4.org/JDFSchema_1_1"	URI	Namespace of the test that is described by @Name in this <i>BasicPreflightTest</i> element.
<i>ListType</i> ?= "SingleValue" Modified in JDF 1.4	enumeration	Specifies what type of list or object the basic preflight test describes. Allowed value is from: ▶ ListType. Modification note: Starting with JDF 1.4, @ListType has a specified default value.
<i>MaxOccurs</i> ="1"	integer	Maximum number of elements in the list described by this <i>BasicPreflightTest</i> (e.g., the maximum number of integers in an integer list). If @MaxOccurs is not "1", the <i>BasicPreflightTest</i> element refers to a list or RangeList of values (e.g., a <i>NameEvaluation</i> will allow a list of NMTOKENS).
<i>MinOccurs</i> ="1"	integer	Minimum number of elements in the list described by this <i>BasicPreflightTest</i> . Default="1" (i.e., it is an individual value). If MinOccurs is not "1", the <i>BasicPreflightTest</i> element refers to a list or RangeList of values (e.g., a <i>NameEvaluation</i> will allow a list of NMTOKENS).
<i>Name</i> Modified in JDF 1.4	NMTOKEN	Local name of the preflight constraint that is evaluated by this <i>BasicPreflightTest</i> . A valid @Name value for the JDF namespace is any property name defined in any of the properties tables in ▶ Section 10.3.2 Properties Preflight tests are defined through the use of constraints. Modification note: Starting with JDF 1.4, @Name is no longer optional.
<i>PreflightArgument</i> ?	element	Additional arguments for the preflight test. For details see ▶ Section 8.111 PreflightParams for the definition of <i>PreflightArgument</i> and constraints upon which preflight tests are defined.

8.111.3 PreflightArgument

This subelement is used by *BasicPreflightTest* when additional data are needed to determine object property.

Table 8.193: PreflightArgument Element

NAME	DATA TYPE	DESCRIPTION
<i>BoxArgument</i> ?	element	Used if <i>BasicPreflightTest</i> /@Name has a value of either "InsideBox" and "OutsideBox". Used for tests with the same two names.
<i>BoxToBoxDifference</i> ?	element	Used by the <i>BoxToBoxDifference</i> test.

8.111.4 BoxArgument

Table 8.194: BoxArgument Element (Sheet 1 of 2)

NAME	DATA TYPE	DESCRIPTION
<i>Box</i>	enumeration	The box type used to verify inclusion or exclusion. Allowed values are from: ▶ BoxType.

Table 8.194: BoxArgument Element (Sheet 2 of 2)

NAME	DATA TYPE	DESCRIPTION
<i>MirrorMargins</i> ?	enumeration	The <i>@MirrorMargins</i> attribute allows the flip of the <i>@Offset</i> value depending on the <i>RunList</i> index. When the index is even, the original <i>@Offset</i> value is preserved. When the index is odd, the <i>@Offset</i> value is flipped. Default behavior: the value of <i>@Offset</i> is not changed (if unspecified). Allowed values are: <i>Vertical</i> – turns [l b r t] into [r b l t]. <i>Horizontal</i> – turns [l b r t] into [l t r b].
<i>Offset</i> ?	rectangle	The offset to build real rectangle to which test is made.
<i>Overlap</i> = "false"	boolean	Explains if overlap is allowed to check inclusion or exclusion.

8.111.5 BoxToBoxDifference

Table 8.195: BoxToBoxDifference Element

NAME	DATA TYPE	DESCRIPTION
<i>FromBox</i> ?	enumeration	The “From” box used for <i>BoxToBoxDifference</i> calculation. Allowed values are from: ▶ <i>BoxType</i> .
<i>ToBox</i> ?	enumeration	The “To” box used for <i>BoxToBoxDifference</i> calculation. Allowed values are from: ▶ <i>BoxType</i> .

Example 8.39: Test with InsideBox and a BoxArgument Subelement

The following is an example of *Test* using *@InsideBox* and a *BoxArgument* subelement:

```
<PreflightParams Class="Parameter" ID="PP001" Status="Available">
  <TestPool>
    <Test ID="PT01">
      <BooleanEvaluation ValueList="true">
        <BasicPreflightTest Name="InsideBox">
          <PreflightArgument>
            <BoxArgument Box="TrimBox" Overlap="true"/>
          </PreflightArgument>
        </BasicPreflightTest>
      </BooleanEvaluation>
    </Test>
  </TestPool>
</ActionPool/>
</PreflightParams>
```

8.112 PreflightProfile

Deprecated in JDF 1.2

PreflightProfile was deprecated as a result of a major revision to the *Preflight* process and its associated resources.

8.113 PreflightReport

New in JDF 1.2

The *PreflightReport* resource describes the results of the preflight tests specified in *PreflightParams*. This section makes use of elements and attributes defined in ▶ Section 10 Device Capabilities. It is suggested that reader’s familiarize themselves with that section and ▶ Section 10.3 Concept of the Preflight Process.

Resource Properties

- Resource Class: **Parameter**
- Input of Processes: **Any Process**

Output of Processes: Preflight

Table 8.196: PreflightReport Resource

NAME	DATA TYPE	DESCRIPTION
ErrorCount ? Modified in JDF 1.4	integer	The count of errors that were encountered while preflighting. Modification note: Starting with JDF 1.4, @ErrorCount is optional.
ErrorState ?	enumerations	Describes the type of errors that occurred during preflighting if the Preflight process does not understand certain preflight tests or cannot apply them to the given objects. Default behavior: no errors occurred (if not specified). Allowed values are: TestNotSupported TestWrongPDL
WarningCount ? Modified in JDF 1.4	integer	The count of warnings that were encountered while preflighting. Modification note: Starting with JDF 1.4, @WarningCount becomes optional.
FileSpec ? New in JDF 1.4	refelement	References a readable preflight report.
PreflightParams	refelement	References the PreflightParams that was used to create this report.
PreflightReportRulePool ? Modified in JDF 1.4	refelement	References the PreflightReportRulePool that was used to create this report. This resource SHALL be provided if the containing PreflightReport is an input resource. Modification note: Starting with JDF 1.4, PreflightReportRulePool becomes optional.
PRItem *	element	Describes the Action elements that produced an error or a warning.
RunList	refelement	References the RunList of documents that were used to create this report.

8.113.1 PRItem

The [PRItem](#) structure is used to describe the errors that occurred during the execution of one [Action](#). If a [Test](#) could not be evaluated during the Preflight process, this is reported as a [PRError](#).

Objects that fail the preflight test are grouped together as described by a [@PRRule](#). During the Preflight process, the number of objects and groups that are reported are limited to the maximum numbers defined in the [@PRRule](#).

When a [PreflightReport](#) is copied from one JDF document to another (e.g., a JDF writer might reduce the size of the [PreflightReport](#) by removing [PRGroup](#) and [PROccurrence](#) items within a [PRGroup](#)), this will not invalidate the [PreflightReport](#).

Table 8.197: PRItem Element

NAME	DATA TYPE	DESCRIPTION
ActionRef	IDREF	References the PreflightParams/ActionPool/Action that triggered this PRItem .
Occurrences	integer	The number of occurrences of objects that failed the Action . When the Action describes a set-test, this is the number of set-objects that failed the test.
PageSet ?	IntegerRangeList	All run indices where there is an object that gives an error on that page.
PRError *	element	Describes the errors that were found while running this preflight test.
PRGroup *	element	Describes the Action elements that produced an error or a warning.

8.113.2 PRError

The [PRError](#) structure is used to describe generic errors that occurred while evaluating an object property while executing a [Test](#).

Table 8.198: PError Element

NAME	DATA TYPE	DESCRIPTION
<i>ErrorType</i>	enumeration	Allowed values are: TestWrongPDL TestNotSupported
<i>Value</i>	NMTOKEN	The name of the object property that was being tested when the process error occurred.

8.113.3 PRGroup

The **PRGroup** structure is used to describe a group of document objects that share common properties and that failed the **Action**.

Table 8.199: PRGroup Element

NAME	DATA TYPE	DESCRIPTION
Occurrences	integer	The number of occurrences of objects of this group that failed the Action . When the Action elements describes a set-test, this is the number of set-objects.
<i>PageSet</i> ?	IntegerRangeList	All run indices where there is an object of this group that gives an error on that page.
<i>PRGroupOccurrence</i> ?	element	The properties that are shared by all elements of the group as defined by PreflightReportRulePool/PRRule/@GroupBy .
<i>PROccurrence</i> *	element	An object that failed the Action .

Depending on the test in the **Action**, the **PRGroup** is used in two different ways:

- When the test is not a set-test, there will be one level of **PRGroup** and **PROccurrence** elements. These are used to describe all the document objects that failed the preflight test. The **PROccurrence** describes the actual object while **PRGroup** is used to group those objects that share common properties.
- When the test is a set-test, there will be two levels of **PRGroup** and **PROccurrence** elements whereby the second level occurs as a child element of **PROccurrence**.
 - The top level describes the set objects that failed the preflight test. Just as in the non-set-test case, **PROccurrence** describes the actual set-objects while **PRGroup** is used to group those sets that share common properties. In the example below there are four page sets that failed the test (e.g., pages 1, 4, 8 and 12).
 - The second level, which is a child element of the top level **PROccurrence**, describes the document objects that are part of the set. These document objects are grouped as well. In the example below, page one consists of 20 objects: five text objects and 15 image objects.

Figure 8-40: PRGroup – a diagram of its structure

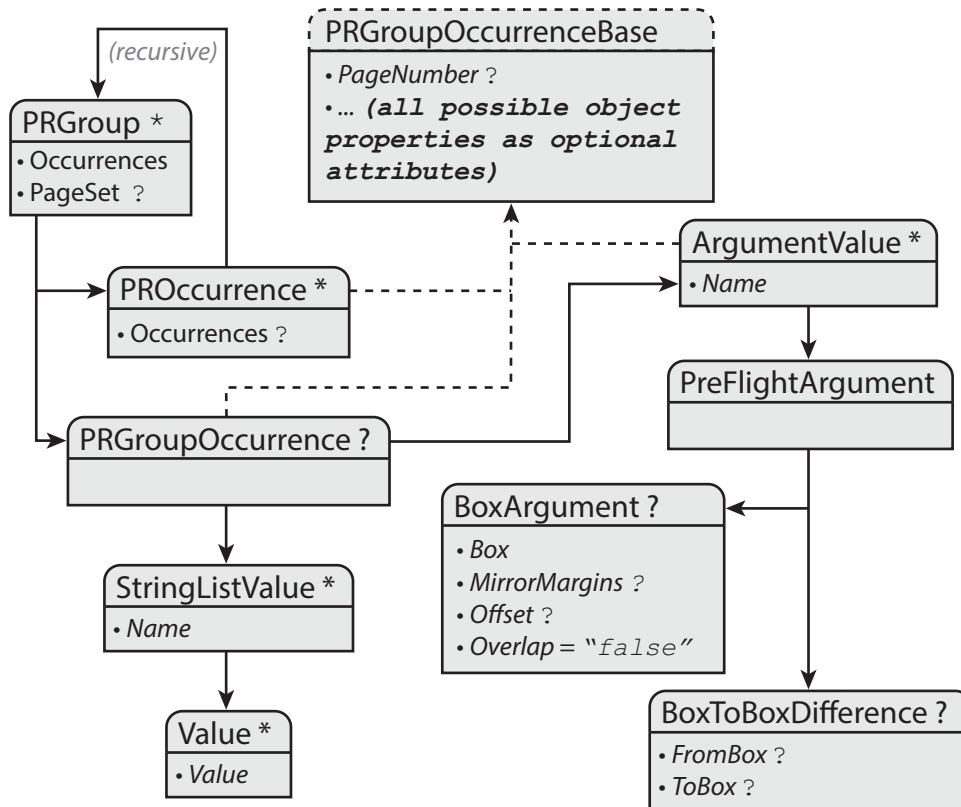

Example 8.40: PRItem

```
<PreflightReport Class="Parameter" ID="PP001" Status="Available" ErrorCount="0" WarningCount="0">
  <PRItem Occurrences="4" ActionRef="A001">
    <PRGroup Occurrences="1">
      <PRGroupOccurrence PageNumber="1"/>
      <PROccurrence Occurrences="20">
        <PRGroup Occurrences="5">
          <PRGroupOccurrence/>
          <PROccurrence TextSize="12"/>
        </PRGroup>
        <PRGroup Occurrences="15">
          <PRGroupOccurrence/>
          <PROccurrence EffectiveResolution="300 300"/>
        </PRGroup>
      </PROccurrence>
    </PRGroup>
    <PRGroup Occurrences="1">
      <PRGroupOccurrence PageNumber="4"/>
      <PROccurrence Occurrences="20">
        <PRGroup Occurrences="7">
          <PRGroupOccurrence/>
          <PROccurrence NumberOfPathPoints="4"/>
        </PRGroup>
        <PRGroup Occurrences="13">
          <PRGroupOccurrence/>
          <PROccurrence EffectiveResolution="300 300"/>
        </PRGroup>
      </PROccurrence>
    </PRGroup>
    <PRGroup Occurrences="1">
      <PRGroupOccurrence PageNumber="8"/>
    </PRGroup>
    <PRGroup Occurrences="1">
      <PRGroupOccurrence PageNumber="12"/>
    </PRGroup>
  </PRItem>
  <PreflightParams>
    <TestPool>
      <Test ID="T001">
        <BooleanEvaluation ValueList="true"/>
      </Test>
    </TestPool>
    <ActionPool>
      <Action ID="A001" TestRef="T001"/>
    </ActionPool>
  </PreflightParams>
  <PreflightReportRulePool/>
  <RunList/>
</PreflightReport>
```

8.113.4 Abstract PRGroupOccurrenceBase

Abstract PRGroupOccurrenceBase is an abstract element that serves as container for properties that were evaluated during the **Preflight** process.

Table 8.200: Abstract PRGroupOccurrenceBase Element

NAME	DATA TYPE	DESCRIPTION
<i>All possible object properties as OPTIONAL attributes.</i>	<i>As defined by the object property.</i>	An example is given above. See also section ▶ Section 10.3.2 Properties and following.
<i>PageNumber ?</i>	integer	Example of an integer attribute. The same format applies to boolean, Number, Name, NameList, enumeration, enumerations and string data types.

8.113.5 PRGroupOccurrenceBase

The following elements are derived from the [Abstract PRGroupOccurrenceBase](#) element

Table 8.201: List of PRGroupOccurrenceBase Elements

NAME	PAGE	DESCRIPTION
ArgumentValue	page 537	For additional arguments for a PRGroupOccurrence .
PRGroupOccurrence	page 537	Specifies shared properties of all PROccurrence elements in a PRGroup .
PROccurrence	page 537	Describes an individual occurrence of a preflight action failure.

8.113.6 ArgumentValue

[ArgumentValue](#) specifies a value that is specified with additional arguments. [ArgumentValue](#) is derived from [Abstract PRGroupOccurrenceBase](#):

Table 8.202: ArgumentValue Element

NAME	DATA TYPE	DESCRIPTION
<i>Name</i>	NMTOKEN	The name of the subject property.
PreflightArgument	element	The argument that was used to evaluate this property. This is a PreflightArgument element. See ▶ Section 8.111.3 PreflightArgument.

8.113.7 PRGroupOccurrence

[PRGroupOccurrence](#) specifies the shared properties of all [PROccurrence](#) elements in a [PRGroup](#). When the object does not support a certain property, the corresponding attribute SHALL NOT be specified in [PRGroupOccurrence](#). [PRGroupOccurrence](#) is derived from [Abstract PRGroupOccurrenceBase](#).

Table 8.203: PRGroupOccurrence Element

NAME	DATA TYPE	DESCRIPTION
ArgumentValue *	element	Describes the value of a property that is enhanced with additional arguments.
StringListValue *	element	Describes the values of a StringList property.

8.113.8 StringListValue

[StringListValue](#) specifies a type that returns a set of strings.

Table 8.204: StringListValue Element

NAME	DATA TYPE	DESCRIPTION
<i>Name</i>	NMTOKEN	The name of the subject property.
<i>Value</i> *	element	Element of type StringEvaluation/Value . See ▶ Section 10.2.13.8.2.13 StringEvaluation.

8.113.9 PROccurrence

[PROccurrence](#) describes an individual occurrence of a preflight action failure. When the object does not support a certain property, the corresponding attribute SHALL NOT be specified in [PROccurrence](#). [PROccurrence](#) is derived from [Abstract PRGroupOccurrenceBase](#).

Table 8.205: PROccurrence Element (Sheet 1 of 2)

NAME	DATA TYPE	DESCRIPTION
<i>Occurrences</i> ?	integer	Only used when the subject occurrence is a set-object. It describes the number of objects in the set.

Table 8.205: PROccurrence Element (Sheet 2 of 2)

NAME	DATA TYPE	DESCRIPTION
<i>PRGroup</i> *	element	When this occurrence describes a set-object, the <i>PRGroup</i> elements describe the objects that are part of the set.

8.114 PreflightReportRulePool

New in JDF 1.2

The *PreflightReportRulePool* resource specifies how the *PreflightReport* SHALL log the errors that were found during the *Preflight* process. This section makes use of elements and attributes defined in ▶ Section 10 Device Capabilities. It is suggested that reader’s familiarize themselves with that section and ▶ Section 10.3 Concept of the Preflight Process.

Resource Properties

Resource Class: Parameter
 Resource referenced by: *PreflightReport*
 Input of Processes: *Preflight*

Table 8.206: PreflightReportRulePool Resource

NAME	DATA TYPE	DESCRIPTION
<i>ActionPools</i> Deprecated in JDF 1.3	IDREFS	References the <i>ActionPool</i> whose reporting are defined by this rule. Deprecation note: Starting with JDF 1.3 Errata, <i>@ActionPools</i> is deprecated because <i>PRRule/@ActionRefs</i> has the same role.
<i>MaxOccurrences</i> ?	integer	An upper bound to the maximum number of <i>PROccurrence</i> elements that are to be logged in the <i>PreflightReport</i> .
<i>PRRule</i> *	element	A list of available <i>PRRule</i> elements.
<i>PRRuleAttr</i> ?	element	Defines the default behavior of all <i>PRRule</i> elements if they are not defined inside of a <i>PRRule</i> subelement.

8.114.1 PRRule

The *PRRule* structure is used to define how the *PreflightReport* SHALL log the events that were found during the execution of one *Action*.

Table 8.207: PRRule Element

NAME	DATA TYPE	DESCRIPTION
<i>ActionRefs</i>	IDREFS	References the action for which the report behavior is defined in <i>PRRule</i> .
<i>PRRuleAttr</i>	element	Defines the way to report this specific rule(s).

The format of the *PreflightReport* is defined by specifying *PRRule* elements for specific *Action* elements. Because *@ActionRefs* can refer to multiple *Action* elements, a single rule applies to all referenced *Action* elements (e.g., all color-related *Action* elements will use similar reporting).

8.114.2 PRRuleAttr

Table 8.208: PRRuleAttr Element (Sheet 1 of 2)

NAME	DATA TYPE	DESCRIPTION
<i>GroupBy</i> ="Tested"	NMTOKENS	Group objects having the same N-pair of attributes listed here. Values include those from: ▶ Table 8.209 ReportAttr Attribute Values.
<i>LogErrors</i> ?	integer	When the <i>Preflight</i> process does not understand or cannot apply certain tests, that error SHALL be logged when the associated type is logged here. The value is the sum of "TestWrongPDL" and "TestNotSupported" (these two returned values are explained in ▶ Section 10.3 Concept of the Preflight Process).

Table 8.208: PRRuleAttr Element (Sheet 2 of 2)

NAME	DATA TYPE	DESCRIPTION
<i>MaxGroups</i> ?	integer	The maximum number of groups allowed in the report for this problem. When an object is encountered that fails the preflight test and it belongs to none of the existing groups and there are already <i>@MaxGroups</i> , that occurrence is no longer reported individually and no new group is created, although it is added to the <i>@Occurrences</i> count and the <i>@PageSet</i> .
<i>MaxPerGroup</i> ?	integer	The maximum number of individual occurrences reported per group for this problem. When an object is encountered that fails the preflight test and it belongs to a group that already contains <i>@MaxPerGroup</i> elements, that occurrence is no longer reported individually, although it is added to the <i>@Occurrences</i> count and the <i>@PageSet</i> .
<i>ReportAttr</i> ="Tested Filename PageNumber"	NMTOKENS	When individual items are reported, these attributes are also reported. Attributes which are also being referred to by <i>@GroupBy</i> are ignored. Values include those from: ▶ Table 8.209 ReportAttr Attribute Values.

Table 8.209: ReportAttr Attribute Values

VALUE	DESCRIPTION
<Property Attribute>	An object-specific attribute (e.g., <i>@ColorSpace</i> , <i>@FontName</i> , etc.). At the time that we define the <i>Test</i> , we will almost automatically define these attributes.
<i>BriefAppSpecific</i>	Refers to a small list of attributes that the preflight agent (with preflight agent-specific logic) finds interesting for the <i>Test</i> element(s) used by the <i>Action</i> element(s) listed in <i>@ActionRefs</i> .
<i>Tested</i>	Indicates that all the attributes that are referred to in the <i>Test</i> element(s) used by the <i>Action</i> element(s) listed in the <i>@ActionRefs</i> .
<i>TestRelated</i>	Refers to all the attributes referred in the <i>Test</i> element(s) used by the <i>Action</i> element(s) listed in <i>@ActionRefs</i> and the ones that belong to the group of properties in which the tested property was found. For instance, if the <i>@Creator</i> basic test was made, then all other document properties will be reported as well.
<i>VerboseAppSpecific</i>	Refers to a large list of attributes that the preflight agent (with preflight agent-specific logic) finds interesting for the <i>Test</i> element(s) used by the <i>Action</i> element(s) listed in <i>@ActionRefs</i> .

When the report is generated, the "Tested", "VerboseAppSpecific" and "BriefAppSpecific" terms are expanded depending on the context (i.e., the specific test and the specific preflight agent) so that the list of attributes only contain object specific attributes.

Note: The "VerboseAppSpecific" and "BriefAppSpecific" tokens can be dependent on the context of a specific test. It is expected that a preflight agent will have a default list of tokens that will always be added (e.g., "PageNumber"). Additionally, it is expected that a preflight agent will define separate lists for specific domains (e.g., color, font). When a specific test covers some of these specific domains, the attributes of these lists are also added. When *@ReportAttr*="Tested BriefAppSpecific PageNumber", the attributes that are reported are dependent on the *Test* element(s) used by the *Action* element(s) and on the preflight agent as demonstrated in the table below.

Table 8.210: Contingent Report Behavior (Sheet 1 of 2)

PREFLIGHT AGENT	FOR COLORSPACE TEST	FOR FONTEMBEDDED TEST	BEHAVIOR
Preflight agent 1	<i>@ColorSpace</i> <i>@PageNumber</i>	<i>@FontEmbedded</i> <i>@PageNumber</i> <i>@FontName</i>	<i>@PageNumber</i> is always added. For color-related tests, <i>@ColorSpace</i> is added. For font-related tests, <i>@FontName</i> is added

Table 8.210: Contingent Report Behavior (Sheet 2 of 2)

PREFLIGHT AGENT	FOR COLORSPACE TEST	FOR FONTEMBEDDED TEST	BEHAVIOR
Preflight agent 2	@ColorSpace @PageNumber @BoundingBox	@FontEmbedded @PageNumber @BoundingBox @FontSubset	@PageNumber and @BoundingBox are always added. For color-related tests, @ColorSpace is added. For font-related tests, @FontName, @FontEmbedded and @FontSubset are added.

When such an attribute is evaluated against an object and when the attribute is a property of the object, value will be recorded as an attribute of the **PROccurrence** and **PRGroupOccurrence** elements. When the attribute is not a property of the object, no attribute will be added to the **PROccurrence** and **PRGroupOccurrence** elements. For example: @TextSize on a text object would give <PROccurrence TextSize="12"/> (assuming @TextSize is defined as returning the size in points), but @TextSize on an image would correspond to <PROccurrence/>.

8.115 Preview

The preview of the content of a surface. It can be used for the calculation of ink coverage (@PreviewUsage="Separation") or as a preview of what is currently processed in a device (@PreviewUsage="Viewable" or @PreviewUsage="ThumbNail"). When the preview is of @PreviewUsage="Separation" or @PreviewUsage="SeparationRaw", a gray value of "0" represents full ink, while a value of "255" represents no ink. For more information, refer to the DeviceGray color model description in the *PostScript Language Reference* ▶ [PostScript].

Resource Properties

- Resource Class: Parameter
- Resource referenced by: ▶ Any Element (generic content), [QueueEntry](#)
- Example Partition: "PreviewType", "Separation", "SheetName", "Side", "TileID", "WebName", "RibbonName"
- Input of Processes: [InkZoneCalculation](#), [PreviewGeneration](#)
- Output of Processes: [PreviewGeneration](#)

Table 8.211: Preview Resource (Sheet 1 of 2)

NAME	DATA TYPE	DESCRIPTION
Compensation ? Modified in JDF 1.2	enumeration	Compensation of the image to reflect the application of transfer curves to the image. Allowed value is from: ▶ Compensation.
CTM ? New in JDF 1.1 Modified in JDF 1.3	matrix	Orientation of the Preview with respect to the Layout coordinate system. CTM is applied after any transformation defined within the referenced image file (e.g., the transformation defined in the CIP3PreviewImageMatrix of a PPF file). In case of PPF, @CTM is applied to the native Postscript coordinate system of the preview. In case of PNG, the origin of the object is defined as the lower left corner of the image.
Directory ? New in JDF 1.1	URL	Defines a base URL for the files that represent this Preview . If @Directory is specified, it SHALL be an absolute URI ▶ [RFC3986] that implicitly also specifies a base URI which is used to resolve any relative URL of Preview . See ▶ Appendix J Resolving Directory URL References and ▶ [FileURL] for examples.
MimeTypeDetails ? New in JDF 1.4	string	Specifies additional details of the preview's MIME type in case the value of @PreviewFileType is a MIME type.

Table 8.211: Preview Resource (Sheet 2 of 2)

NAME	DATA TYPE	DESCRIPTION
<p><i>PreviewFileType</i> = "PNG"</p> <p>New in JDF 1.2</p> <p>Modified in JDF 1.4</p>	string	<p>The file type of the preview.</p> <p>Values include:</p> <p>CIP3Multiple – The format as defined in ▶ [CIP3 – PPF]. One or more previews per CIP3 file are supported.</p> <p>CIP3Single – The format as defined in ▶ [CIP3 – PPF]. Only one preview per CIP3 file is supported.</p> <p>PNG – The Portable Network Graphics format. See ▶ [ISO/IEC 15948:2004].</p> <p>Values include also: Any MIME media type. See ▶ Appendix G MimeTypes.</p> <p>New in JDF 1.4</p> <p>Note: The CIP3 formats were added in JDF 1.2 only for backwards compatibility since many systems only support CIP3 format. The CIP3 formats SHALL NOT be used except in <i>Preview</i> resources that are used as input resources to <i>InkZoneCalculation</i>.</p> <p>Modification note: Starting with JDF 1.4, the Data Type is changed from enumeration to string because MIME media types are added as values.</p>
<p><i>PreviewType</i> ?</p> <p>Deprecated in JDF 1.2</p>	enumeration	<p>Type of the preview.</p> <p>Allowed values are:</p> <p>Separation – Separated preview in medium resolution.</p> <p>SeparationRaw – Separated preview in medium resolution with no compensation.</p> <p>SeparatedThumbNail – Very low resolution separated preview.</p> <p>ThumbNail – Very low resolution RGB preview.</p> <p>Viewable – RGB preview in medium resolution.</p> <p>Deprecation note: Starting with JDF 1.2, <i>@PreviewType</i> is still a partition key and SHALL be used only as such — as an attribute of <i>Preview</i>, <i>@PreviewUsage</i> (below) replaces <i>@PreviewType</i>.</p>
<p><i>PreviewUsage</i> = "Separation"</p> <p>New in JDF 1.2</p> <p>Modified in JDF 1.5</p>	enumeration	<p>The intended use of the preview.</p> <p><i>@PreviewUsage</i> defines the semantics of the preview.</p> <p>Constraint: If both <i>@PreviewType</i> as a partition key and <i>@PreviewUsage</i> are specified, they SHALL match.</p> <p>Allowed values are from: ▶ PreviewUsage.</p>
<p><i>URL</i></p> <p>Modified in JDF 1.2</p>	URL	<p><i>@URL</i> identifying any preview file (e.g., the PNG image or ▶ [CIP3 – PPF] file that represents this <i>Preview</i>).</p> <p>See ▶ [RFC3986] and ▶ Appendix J Resolving Directory URL References and ▶ Appendix L FileSpec Use Cases for the syntax and examples. For the "file" URL scheme see also ▶ [RFC1738] and ▶ [FileURL].</p> <p>Note: A preview will generally be partitioned by separation, unless it represents an RGB viewable image or thumbnail. PPF files with multiple images can contain multiple separations. In this case, the separation names defined in CIP3ADMSeparationNames define the separations and SHALL match the <i>@Separation</i> partition keys used in the JDF.</p>

8.116 PreviewGenerationParams

Parameters specifying the size and the type of the preview.

Resource Properties

Resource Class:

Parameter

Example Partition:

"PreviewType", "Separation", "SheetName", "Side", "TileID", "WebName", "RibbonName"

Input of Processes: **PreviewGeneration**

Table 8.212: PreviewGenerationParams Resource (Sheet 1 of 2)

NAME	DATA TYPE	DESCRIPTION
<p><i>AspectRatio</i> = "Ignore" New in JDF 1.1</p>	enumeration	<p>Policy that defines how to define the preview size if the aspect ratio of the source and preview are different. <i>@AspectRatio</i> SHALL NOT be specified unless <i>@Size</i> is also specified.</p> <p>Allowed values are:</p> <p>CenterMax – Keep the aspect ratio and preview <i>@Size</i>, and center the image so that the preview has missing pixels at both sides of the larger dimension.</p> <p>CenterMin – Keep the aspect ratio and preview <i>@Size</i>, and center the image so that the preview has blank pixels at both sides of the smaller dimension.</p> <p>Crop – Keep the aspect ratio, and modify the preview size so that the image fits into a bounding rectangle defined by <i>@Size</i>.</p> <p>Expand – Keep the aspect ratio, and modify the preview size so that the smaller image dimension is defined by <i>@Size</i>.</p> <p>Ignore – Fill the preview completely, keeping <i>@Size</i>, even if this requires modifying the aspect ratio.</p>
<p><i>Compensation</i> ? Modified in JDF 1.2</p>	enumeration	<p>Compensation of the image to reflect the application of transfer curves to the image.</p> <p>Allowed value is from: ▶ Compensation.</p>
<p><i>PreviewFileType</i>= "PNG" New in JDF 1.2</p>	enumeration	<p>The file type of the preview to be generated.</p> <p>Allowed values are:</p> <p>PNG – The Portable Network Graphics format.</p> <p>CIP3Multiple – The format as defined in ▶ [CIP3 – PPF]. One or more previews per CIP3 file are supported.</p> <p>CIP3Single – The format as defined in ▶ [CIP3 – PPF]. Only one preview per CIP3 file is supported.</p> <p>Note: The CIP3 formats were added in JDF 1.2 only for backwards compatibility, since many systems only support CIP3 format. The CIP3 formats SHALL NOT be used except in Preview resources that are used as input resources to InkZoneCalculation.</p>
<p><i>PreviewType</i> ? Deprecated in JDF 1.1</p>	enumeration	<p>The type of preview to be generated.</p> <p>Allowed values are:</p> <p>Separation Viewable</p> <p>Deprecation note: Starting with JDF 1.1, <i>@PreviewType</i> is still a partition key and SHALL be used only as such — as an attribute of Preview, <i>@PreviewUsage</i> (below) replaces <i>@PreviewType</i>.</p>
<p><i>PreviewUsage</i>= "Separation" New in JDF 1.1 Modified in JDF 1.2</p>	enumeration	<p>The intended use for the preview to be generated.</p> <p>Allowed values are:</p> <p>Separation – Separated preview in medium resolution.</p> <p>SeparationRaw – Separated preview in medium resolution with no compensation.</p> <p>SeparatedThumbNail – Very low resolution separated preview.</p> <p>ThumbNail – Very low resolution RGB preview.</p> <p>Viewable – RGB preview in medium resolution.</p> <p>Constraint: <i>@PreviewUsage</i> defines the semantics of the preview. If both <i>@PreviewType</i> as a partition key and <i>@PreviewUsage</i> are specified, they SHALL match.</p>
<p><i>Resolution</i> ?</p>	XYPair	<p>Resolution of the preview, in dpi. If <i>@PreviewUsage</i>= "Separation", the default is "50.8 50.8".</p>
<p><i>Size</i> ?</p>	XYPair	<p>Size of the preview, in pixels. If <i>@Size</i> is present, <i>@Resolution</i> SHALL be evaluated according to the policy defined in <i>@AspectRatio</i>. If <i>@Size</i> is not specified, it SHALL be calculated using the <i>@Resolution</i> attribute and the input image size.</p>

Table 8.212: PreviewGenerationParams Resource (Sheet 2 of 2)

NAME	DATA TYPE	DESCRIPTION
ImageSetterParams ? New in JDF 1.1	reference	Details of the ImageSetting process. Needed for accessing information about coordinate transformations that are performed by the imagesetter hardware.

8.117 PrintCondition

New in JDF 1.2

PrintCondition is a resource used to control the use of colorants when printing pages on a specific media. The attributes and elements of the **PrintCondition** resource describe the target values for a given printing process.

Resource Properties

Resource Class: Parameter

Example Partition: "SignatureName", "SheetName", "Side", "Separation"

Input of Processes: **ConventionalPrinting**, **DigitalPrinting**

Table 8.213: PrintCondition Resource

NAME	DATA TYPE	DESCRIPTION
AimCurve ?	Transfer-Function	Describes the desired tone-value increase function. If not specified, it defaults to the media and printing machine specific values.
Density ?	double	Density value of colorant (100% tint). Whereas Color/@NeutralDensity describes measurements of inks on substrate with wide-band filter functions, @Density is derived from measurements of inks on substrate with special small band filter functions according to ANSI and DIN. If not specified, it defaults to the value of Color//@Density .
Name	string	PrintStandard specifies the reference name of a characterization data set. There are research and trade associations (such as Fogra, IDEAlliance, WAN-IFRA, JPMA, ICC) who provide characterization data sets for standard printing conditions. Most reference names of standard printing conditions are registered with the ICC see ▶ [Characterization Data]. Official reference names shall be taken if a standard printing condition exists. Custom or device dependent reference names MAY be introduced or provided if no official standard printing condition exists or is available. Note: Whereas PrintStandard defines a media independent characterization data set, PrintConditionColor/@PrintConditionName defines a characterization data set that is applied to a specific setup, including paper selection and screening setup.
ColorMeasurementConditions ?	reference	Describes measurement conditions for color measurement and density measurement. If not specified, it defaults to the value of Color//ColorMeasurementConditions .
Device ?	reference	Specifies the device or device group that this PrintCondition applies to.
FileSpec (TargetProfile) ?	reference	A FileSpec resource pointing to an ICC profile that defines the target output device in case the object that uses the color has been color space converted to a device color space. If not specified, it defaults to the value of Color//FileSpec (TargetProfile) .

Example 8.41: PrintCondition

```
<ColorMeasurementConditions Class="Parameter" ID="MyColorMeasCond" Status="Available"/>
<PrintCondition Class="Parameter" ID="PC" Name="Standard"
  PartIDKeys="Side Separation" Status="Available">
  <ColorMeasurementConditionsRef rRef="MyColorMeasCond"/>
  <PrintCondition Side="Front">
    <PrintCondition AimCurve="0.0 0.0 0.5 0.66 1.0 1.0"
      Density="1.8" Separation="Black"/>
    <PrintCondition AimCurve="0.0 0.0 0.5 0.63 1.0 1.0"
      Density="1.4" Separation="Cyan"/>
  </PrintCondition>
</PrintCondition>
```

8.118 PrintRollingParams

New in JDF 1.2

Resource Properties

Resource Class: Parameter

Input of Processes: **PrintRolling**

Table 8.214: PrintRollingParams Resource

NAME	DATA TYPE	DESCRIPTION
<i>Copies</i> ?	integer	Number of copies on the roll. @ <i>Copies</i> SHALL NOT be specified if @ <i>MaxDiameter</i> is present.
<i>MaxDiameter</i> ?	double	Maximal allowed diameter of roll. @ <i>MaxDiameter</i> SHALL NOT be specified if @ <i>Copies</i> is present.

Figure 8-41: PrintRollingParams coordinate system

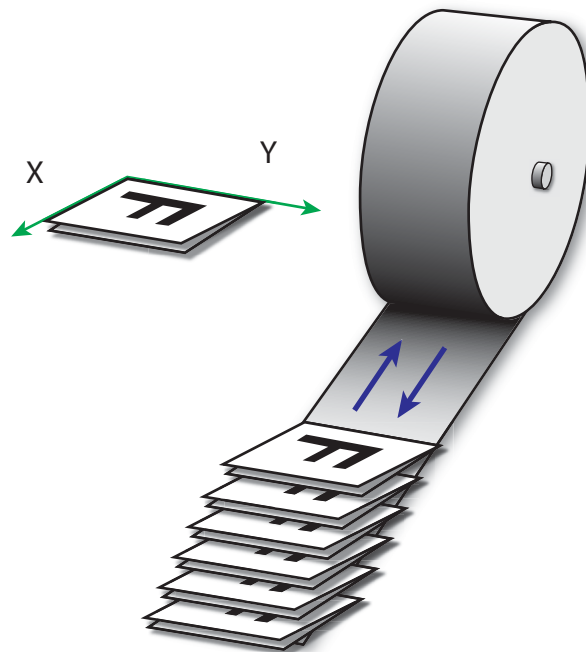

8.119 ProductionPath

New in JDF 1.3

ProductionPath describes the individual paper path through the different modules of a web-press device, in order to produce a particular product.

Resource Properties

Resource Class: Parameter

Resource referenced by: [CylinderLayoutPreparationParams](#)

Example Partition: "RibbonName", "WebName"

Input of Processes: [WebInlineFinishing](#)

Table 8.215: ProductionPath Resource

NAME	DATA TYPE	DESCRIPTION
ProductionPathID ?	string	Identification of the entire production path. The @ProductionPathID SHALL be unique within the machine. If not specified, PrintingUnitWebPath SHALL be specified.
FolderSuperstructureWebPath ?	element	Describes the path through the folder super-structure. The web will generally be cut into ribbons in this region of the production path.
PostPressComponentPath *	element	Describes the path through the inline postpress equipment. Folded sheets (Component) will be processed in this region of the production path.
PrintingUnitWebPath ?	element	Describes the path through the printing units. If not specified, @ProductionPathID SHALL be specified.

8.119.1 FolderSuperstructureWebPath

This is a placeholder that might be filled with additional information in future versions of **JDF**. In **JDF** 1.3, paths are identified by ID only.

Table 8.216: FolderSuperstructureWebPath Element

NAME	DATA TYPE	DESCRIPTION
ProductionPathID ?	string	Unique identification of the part of the production path specified in this element.

8.119.2 PostPressComponentPath

This is a placeholder that might be filled with additional information in future versions of **JDF**. In **JDF** 1.3, paths are identified by ID only.

Table 8.217: PostPressComponentPath Element

NAME	DATA TYPE	DESCRIPTION
ProductionPathID ?	string	Unique identification of the part of the production path specified in this element.

8.119.3 PrintingUnitWebPath

This is a placeholder that might be filled with additional information in future versions of **JDF**. In **JDF** 1.3, paths are identified by ID only.

Table 8.218: PrintingUnitWebPath Element

NAME	DATA TYPE	DESCRIPTION
ProductionPathID ?	string	Unique identification of the part of the production path specified in this element.

Example 8.42: ProductionPath: on Path Level:

This example and the next illustrate the different web path description levels:

```
<ProductionPath Class="Parameter" ID="F1"
  ProductionPathID="ID_2webproduction_64pages" Status="Available"/>
```

Example 8.43: ProductionPath: on Part Path Level:

This example and the previous illustrate the different web path description levels:

```
<ProductionPath Class="Parameter" ID="F1" PartIDKeys="WebName" Status="Available">
  <ProductionPath WebName="1">
    <PrintingUnitWebPath ProductionPathID="ID_PrintingUnitWebPath"/>
    <FolderSuperstructureWebPath ProductionPathID="abcd"/>
    <PostPressComponentPath ProductionPathID="xyz"/>
  </ProductionPath>
</ProductionPath>
```

8.120 ProofingParams

Deprecated in JDF 1.2

In **JDF** 1.2 and beyond, proofing is handled as a combined process.

8.121 PSToPDFConversionParams

PSToPDFConversionParams contains the parameters that control the conversion any PDL to PDF documents. Prior to **JDF** 1.3, **PSToPDFConversionParams** was used only for converting PostScript streams to PDF. The name “**PSToPDFConversionParams**” was retained for backwards compatibility, although most parameters apply to PDF conversion from any source format.

Some descriptions below mention attributes or structures in specific source formats, such as PostScript. Appropriate equivalent actions should be taken when converting from other source formats that have equivalent attributes or structures. A small number of parameters apply only to PostScript sources.

Resource Properties

Resource Class: **Parameter**

Resource referenced by: **PDLCreationParams**

Example Partition: **"DocIndex", "RunIndex", "RunTags", "DocTags", "PageTags", "SetTags", "SheetName", "Side", "SignatureName"**

Input of Processes: **PSToPDFConversion**

Table 8.219: **PSToPDFConversionParams** Resource (Sheet 1 of 2)

NAME	DATA TYPE	DESCRIPTION
<i>AllowJBIG2Globals</i> = "false"	boolean	This resource allows JBIG2 compressed images to share a single global dictionary in the resulting PDF file instead of a dictionary per image.
<i>ASCII85EncodePages</i> = "false"	boolean	If "true", binary streams (e.g., page contents streams, sampled images, and embedded fonts) are ASCII85-encoded, resulting in a PDF file that is almost pure ASCII. If "false", they are not, resulting in a PDF file that can contain substantial amounts of binary data.
<i>AutoRotatePages</i> ?	enumeration	Allows the device to attempt to orient pages based on the predominant text orientation. If the source is PostScript, this attribute is only used if the file does not contain “%%ViewingOrientation”, “%%PageOrientation” or “%%Orientation” DSC comments. If the file does contain such DSC comments, it honors them. “%%ViewingOrientation” takes precedence over others, followed by “%%PageOrientation”, and then “%%Orientation”. Allowed values are: None – Turns @AutoRotatePages off. All – Takes the predominant text orientation across all pages and rotates all pages the same way. PageByPage – Executes the rotation on a page-by-page basis, rotating each page individually. Useful for documents that use both portrait and landscape orientations.
<i>Binding</i> ="Left"	enumeration	Determines how the printed pages are bound. Allowed values are: Left – for left binding. Right – for right binding.

Table 8.219: PSToPDFConversionParams Resource (Sheet 2 of 2)

NAME	DATA TYPE	DESCRIPTION
CompressPages ?	boolean	Enables compression of pages and other content streams such as forms, patterns and Type 3 fonts. If "true", use Flate compression.
DefaultRenderingIntent ? Modified in JDF 1.2	enumeration	Selects the rendering intent for the current job. Allowed value is from: ▶ RenderingIntent.
DetectBlend="true"	boolean	Enables or disables blend detection. If "true" and if @PDFVersion is 1.3 or higher, then blends will be converted to smooth shadings.
DoThumbnails="true"	boolean	If "true", thumbnails are created.
EndPage ? Deprecated in JDF 1.3	integer	Number that indicates the last page that is displayed when the PDF file is viewed. @EndPage SHALL be either "-1" or greater than or equal to @StartPage . When combined with @StartPage , @EndPage selects a range of pages to be displayed. The entire file MAY be converted, but only @StartPage to @EndPage pages, inclusive, are opened and viewed in a PDF viewing application.
ImageMemory ? Deprecated in JDF 1.2	integer	Number of bytes in the buffer used in sample processing for color, grayscale and monochrome images. Its contents are written to disk when the buffer fills up. This attribute was deprecated because it is an internal application setting and not a parameter setting.
InitialPageSize ? New in JDF 1.1	XYPair	Defines the initial page dimensions, in points, that will be used to set Media-Box. This will be overridden by any page size attribute found in the source document, such as the PostScript PageSize page device parameter. The use of this attribute is strongly encouraged when processing EPS files (%%BoundingBox comments do not override @InitialPageSize).
InitialResolution ? New in JDF 1.1	XYPair	Defines the initial horizontal and vertical resolution, in dpi. This will be overridden by any resolution attribute found in the source document, such as the PostScript HWResolution page device parameter. The use of this attribute is strongly encouraged when processing EPS files.
Optimize="true"	boolean	If "true", the PS-to-PDF converter optimizes the PDF file. See ▶ [PDF1.6] for more information on optimization.
OverPrintMode ?	integer	Controls the overprint mode strategy of the job. Set to "0" for full overprint or "1" for non-zero overprint. For more information, see ▶ [ColorPS].
PDFVersion ?	double	Specifies the version number of the PDF file produced. Values include all legal version designators (e.g., 1.2, 1.5).
StartPage ? Deprecated in JDF 1.3	integer	Sets the first page that is to be displayed when the PDF file is opened with a PDF viewing application. @StartPage SHALL be greater than or equal to 1. @EndPage SHALL be either "-1" or greater than or equal to @StartPage .
AdvancedParams ?	element	Advanced parameters which control how certain features of PDF are handled.
PDFXParams ? New in JDF 1.2	element	PDF/X parameters.
ThinPDFParams ?	element	Parameters that control the optional content or form of PDF files that will be created.

8.121.1 AdvancedParams

Table 8.220: AdvancedParams Element (Sheet 1 of 2)

NAME	DATA TYPE	DESCRIPTION
<i>AllowPSXObject</i> s="true" New in JDF 1.2	boolean	If "true", allows PostScript XObjects .
<i>AllowTransparency</i> ="false" New in JDF 1.2	boolean	If "true", allows transparency in the PDF.
<i>AutoPositionEPSInfo</i> ="true" Modified in JDF 1.1A	boolean	If "true", the process automatically resizes and centers information from EPS source files on the page. (EPS source only)
<i>EmbedJobOptions</i> ="false" New in JDF 1.2	boolean	If "true", the PDF settings used to create the PDF are embedded in the PDF.
<i>EmitDSCWarnings</i> ="false"	boolean	If "true", warning messages about questionable or incorrect DSC comments appear during the processing of the source PostScript file. (PostScript source only)
<i>LockDistillerParams</i> ="true"	boolean	If "true", any <i>PSToPDFConversionParams</i> settings configured by the source content (e.g., with setdistillerparams in a PostScript source document) are ignored. If "false", each parameter defined in the source document overrides that set in the JDF .
<i>ParseDSCComment</i> ForDocInfo="true"	boolean	If "true", the process parses the DSC comments in a PostScript source file and extracts the document information. This information is recorded in the Info dictionary of the PDF file.
<i>ParseDSCComments</i> ="true"	boolean	If "true", the process parses the DSC comments in a PostScript source document for any information that might be helpful for converting the file or for information that is to be stored in the PDF file. If "false", the process treats the DSC comments as pure PS comments and ignores them. (PostScript source only)
<i>PassThroughJPEGImages</i> ="false" New in JDF 1.2	boolean	If "true", JPEG images are passed through without recompressing them.
<i>PreserveCopyPage</i> ="true"	boolean	If "true", the copypage operator of PostScript Level 2 is maintained. If "false", the PostScript Level 3 definition of copypage operator is used. In PostScript Levels 1 and 2, the copypage operator transmits the page contents to the current output device (similar to showpage). However, copypage does not perform many of the re-initializations that showpage does. Many PostScript Level 1 and 2 programs used the copypage operator to perform such operations as printing multiple copies and implementing forms. These programs produce incorrect results when interpreted using the Level 3 copypage semantics. This attribute provides a mechanism for retaining Level 2 compatibility for this operator. (PostScript source only)
<i>PreserveEPSInfo</i> ="true"	boolean	If "true", preserves the EPS information in a PostScript source file and stores it in the resulting PDF file. (PostScript source only)
<i>PreserveHalftoneInfo</i> ="false" New in JDF 1.1	boolean	If "true", passes halftone screen information (frequency, angle and spot function) into the PDF file. If "false", halftone information is not passed in.
<i>PreserveOPIComments</i> ="true"	boolean	If "true", encapsulates Open Prepress Interface (OPI) low resolution images as a form and preserves information for locating the high resolution images.

Table 8.220: AdvancedParams Element (Sheet 2 of 2)

NAME	DATA TYPE	DESCRIPTION
<i>PreserveOverprintSettings="true"</i> New in JDF 1.1	boolean	If "true", passes the value of the setoverprint operator through to the PDF file. Otherwise, overprint is ignored.
<i>TransferFunctionInfo="Preserve"</i> New in JDF 1.1	enumeration	Determines how transfer functions are handled. Allowed values are: Preserve – Transfer functions are passed into the PDF file. Remove – Transfer functions are ignored. They are neither applied to the color values nor passed into the PDF file. Apply – Transfer functions are used to modify the data that are written to the PDF file, instead of writing the transfer function itself to the file.
<i>UCRandBGInfo="Preserve"</i> New in JDF 1.1	enumeration	Determines whether the under-color removal and black-generation parameters from the source document (e.g., the arguments to the PostScript commands setundercolorremoval and setblackgeneration) are passed into the PDF file. Allowed values are: Preserve – The arguments are passed into the PDF file. Remove – The arguments are ignored.
<i>UsePrologue="false"</i>	boolean	If "true", the process SHALL append a PostScript prologue file before the beginning of the job and append a PostScript epilog file after the end the job. Such files are used to control the PostScript environment for the conversion process. The expected location and allowable contents for these files is defined by the process implementation. (PostScript source only)

8.121.2 PDFXParams

New in JDF 1.2

Parameters for generating PDF/X files.

Note: TrimBox, BleedBox, output intent and the Trapped state may be provided by the use of the **pdfmark** operator in a PostScript source file.

Table 8.221: PDFXParams Element (Sheet 1 of 2)

NAME	DATA TYPE	DESCRIPTION
<i>PDFX1aCheck="false"</i> Deprecated in JDF 1.5	boolean	If "true", checks compliance with the PDF/X-1a standard ▶ [ISO15930-1:2001]. Deprecation note: Use <i>@PDFXCheck</i> instead.
<i>PDFX3Check="false"</i> Deprecated in JDF 1.5	boolean	If "true", checks compliance with the PDF/X-3 standard ▶ [ISO15930-3:2002]. Deprecation note: Use <i>@PDFXCheck</i> instead.
<i>PDFXBleedBoxtoTrimBoxOffset?</i>	rectangle	If the BleedBox entry is not specified in the page object of the source document, BleedBox is set to PDF TrimBox with offsets. All numbers SHALL be greater than or equal to 0.0. PDF BleedBox will be completely outside PDF TrimBox .
<i>PDFXCheck?</i> New in JDF 1.5	NMTOKENS	List of PDF/X versions that the output SHALL be compliant with. Values include: X1a – see the PDF/X-1a standard ▶ [ISO15930-1:2001]. X3 – see the PDF/X-3 standard ▶ [ISO15930-3:2002]. X4 – see the PDF/X-4 standard ▶ [ISO15930-7:2010]. X5 – see the PDF/X-5 standard ▶ [ISO15930-8:2010].
<i>PDFXCompliantPDFOnly="false"</i>	boolean	If "true", produces a PDF document only if PDF/X compliance tests are passed.
<i>PDFXNoTrimBoxError="true"</i>	boolean	If "true" and both TrimBox and ArtBox entries are not specified in the page object of the source document, the condition is reported as an error.
<i>PDFXOutputCondition?</i>	string	The string is an optional comment which is added to the PDF file. It describes the intended printing condition in a form that ought to be meaningful to a human operator at the site receiving the PDF document.

RESOURCES

Table 8.221: PDFXParams Element (Sheet 2 of 2)

NAME	DATA TYPE	DESCRIPTION
<i>PDFXOutputIntentProfile?</i>	string	If the source document does not specify an output intent name, then this value is used. Values include those from: ▶ Table 8.222 PDFXOutputIntentProfile Attribute Values.
<i>PDFXRegistryName</i>	URL	Indicates a location at which more information regarding the registry that defines the OutputConditionIdentifier can be obtained.
<i>PDFXSetBleedBoxToMediaBox="true"</i>	boolean	If "true" and the BleedBox entry is not specified in the page object of the source document, BleedBox is set to MediaBox .
<i>PDFXTrapped?</i>	enumeration	If a source document does not specify a Trapped state, then the value provided here is used. The value "Unknown" SHALL be used for workflows requiring 1) that the document specify a Trapped state and 2) that compliance checking fail if Trapped is not present in the document. Allowed values are: Unknown false true Note: "Unknown" is prohibited in PDF/X files.
<i>PDFXTrimBoxToMediaBoxOffset?</i>	rectangle	If both the TrimBox and ArtBox entries are not specified in the page object of the source document, TrimBox is set to MediaBox with offsets. All numbers SHALL be greater than or equal to 0.0. The TrimBox will be completely inside MediaBox .

Table 8.222: PDFXOutputIntentProfile Attribute Values

VALUE	DESCRIPTION
None	Used when it is REQUIRED that the source document specifies an intent; allows compliance checking to fail
Euroscale Coated v2	
Euroscale Uncoated v2	
Japan Color 2001 Coated	
Japan Color 2001 Uncoated	
Japan Standard v2	
Japan Web Coated (Ad)	
U.S. Sheetfed Coated v2	
U.S. Sheetfed Uncoated v2	
U.S. Web Coated (SWOP) v2	
U.S. Web Uncoated v2	
Photoshop 4 Default CMYK	
Photoshop 5 Default CMYK	

8.121.3 ThinPDFParams

Table 8.223: ThinPDFParams Element (Sheet 1 of 2)

NAME	DATA TYPE	DESCRIPTION
<i>FilePerPage = "false"</i>	boolean	If "true", the process generates 1 PDF file per page.

Table 8.223: ThinPDFParams Element (Sheet 2 of 2)

NAME	DATA TYPE	DESCRIPTION
<i>SidelineEPS</i> = "false" New in JDF 1.2	boolean	If "true", embedded EPS files in PostScript source documents are not converted but are stored in external files in the same location as the PDF itself. (PostScript source only)
<i>SidelineFonts</i> = "false"	boolean	If "true", font data are stored in external files during PDF generation.
<i>SidelineImages</i> = "false"	boolean	If "true", image data are stored in an external stream during the PDF Generation phase. This prevents large amounts of image data from having to be passed through all phases of the code generation process.

8.122 QualityControlParams

New in JDF 1.2

QualityControlParams defines the set of parameters for the quality control process. The specific measurement conditions SHOULD be defined in specialized subelements such as **BindingQualityParams** or as subelements that are in a foreign namespace. Parameters for **QualityControl** MAY also be referenced by providing a **FileSpec** that references a proprietary setup definition. Examples for quality control setup in a foreign namespace include ▶ [ISO17972-1:2015] for color measurement data.

Resource Properties

Resource Class: Parameter

Input of Processes: QualityControl

Table 8.224: QualityControlParams Resource

NAME	DATA TYPE	DESCRIPTION
<i>SampleInterval</i> ?	integer	Interval in number of samples between tests.
<i>TimeInterval</i> ?	duration	Time interval between individual tests.
BindingQualityParams ?	element	Specification of the binding quality measurements.
FileSpec ? New in JDF 1.6	reference	Location of an external file that contains details of the quality control setup.

8.122.1 BindingQualityParams

The set of parameters in **BindingQualityParams** identifies how the quality of the binding is verified.

8.122.1.1 Pull test

In the pull test (sheet pulling test), a single sheet is subjected to slowly increasing tensile loading until it comes away from the glue film or the material breaks down. The load increases constantly during the automatic test procedure. It is applied evenly along the whole length of the glued seam.

Note: That is why the pull test is also described as a static test method.

8.122.1.2 Flex test

The page flex test (page turning test) is used more and more rarely in quality checking, not least because it is time consuming. In the page flex test a sheet is moved back and forth under varying tensile loads, usually at 1 N/cm, until it pulls out of the glue film, with the number of to and fro movements being measured automatically.

Note: As this test procedure involves a rapid turning movement, the flex test is called a dynamic test procedure.

Table 8.225: BindingQualityParams Element

NAME	DATA TYPE	DESCRIPTION
<i>FlexValue</i> ?	double	Flex quality parameter measured in [N/cm].
<i>PullOutValue</i> ?	double	Pull out quality parameter measured in [N/cm].

8.123 QualityControlResult

New in JDF 1.2

QualityControlResult defines the set of results from a **QualityControl** process. The specific measurements should be returned in specialized subelements such as **QualityMeasurement** or as subelements that are in a foreign namespace. **QualityControl** results may also be referenced by providing a **FileSpec** that references a proprietary measurement results definition. Examples for quality control measurements in a foreign namespace include ▶ [ISO17972-1:2015] for color measurement data.

Resource Properties

Resource Class: **Parameter**
 Resource referenced by: **Abstract Resource**
 Output of Processes: **QualityControl**

Table 8.226: QualityControlResult Resource

NAME	DATA TYPE	DESCRIPTION
<i>End</i> ? New in JDF 1.6	dateTime	Date and time of the end of the measurement. If not specified, the value of <i>@Start</i> is applied.
<i>Failed</i> ?	integer	Total number of failed measurements.
<i>Passed</i> ?	integer	Total number of passed measurements.
<i>Start</i> ? New in JDF 1.6	dateTime	Date and time of the start of the measurement. If not specified, the measurement time is not known.
<i>BindingQualityParams</i> ?	element	Reference to the measurement setup definition.
<i>FileSpec</i> ?	refelement	Location of an external file that contains details of the quality control measurement.
<i>QualityMeasurement</i> t *	element	One individual measurement result.

8.123.1 QualityMeasurement

QualityMeasurement elements describe an individual measurement.

Table 8.227: QualityMeasurement Element

NAME	DATA TYPE	DESCRIPTION
<i>Condition</i> ?	NMTOKEN	Condition of the tested Component . If the Component passed the test, but the test itself destroyed the Component , the value SHALL be set to "destroyed". Values include: destroyed
<i>End</i> ?	dateTime	Date and time of the end of the measurement. If not specified, the value of <i>@Start</i> is applied.
<i>Failed</i> ?	integer	Total number of failed measurements.
<i>Passed</i> ?	integer	Total number of passed measurements.
<i>Start</i> ?	dateTime	Date and time of the start of the measurement. If not specified, the measurement time is not known.
<i>BindingQualityMeasurement</i> ?	element	Details of the BindingQualityMeasurement .

8.123.2 BindingQualityMeasurement

Table 8.228: BindingQualityMeasurement Element

NAME	DATA TYPE	DESCRIPTION
<i>FlexValue</i> ?	double	Flex quality parameter given in [N/cm].
<i>PullOutValue</i> ?	double	Pull out quality parameter given in [N/cm].

8.124 RasterReadingParams

New in JDF 1.3

This set of parameters specifies the details for **RasterReading**.

Resource Properties

Resource Class: Parameter

Input of Processes: **RasterReading**

Table 8.229: RasterReadingParams Resource

NAME	DATA TYPE	DESCRIPTION
<i>Center</i> = "false"	boolean	Indicates whether or not the finished page image SHALL be centered within the imagable area of the media. <i>@Center</i> SHALL NOT be specified if <i>FitPolicy</i> / <i>@SizePolicy</i> ="ClipToMaxPage" and clipping is requested.
<i>MirrorAround</i> = "None"	enumeration	This attribute specifies the axis around which a raster reader SHALL mirror an image. Allowed value is from: ▶ Axis.
<i>Polarity</i> = "Positive"	enumeration	The image SHALL be RIPed in the polarity specified. Note that this is a polarity change in the RIP and not a polarity change in the hardware of the output device. Allowed value is from: ▶ Polarity.
<i>Poster</i> ? Deprecated in JDF 1.5	XYPair	Specifies whether the page contents SHALL be expanded such that each page covers X by Y pieces of media. Deprecation note: Starting with JDF 1.5 , use Tiling (▶ Section 6.3.41 Tiling).
<i>PosterOverlap</i> ? Deprecated in JDF 1.5	XYPair	This pair of real numbers identifies the amounts of overlap in points, that specify the poster tiles across the horizontal and vertical axes, respectively. Deprecation note: Starting with JDF 1.5 , use Tiling (▶ Section 6.3.41 Tiling).
<i>Scaling</i> ?	XYPair	A pair of positive real values that indicates the scaling factor for the content. Values between 0 and 1 specify that the contents SHALL be reduced, while values greater than 1 specify that the contents SHALL be expanded. Any scaling defined in <i>FitPolicy</i> SHALL be applied after the scaling defined by this attribute.
<i>ScalingOrigin</i> ?	XYPair	A pair of real values that identify the point in the unscaled page that SHALL become the origin of the new, scaled page image. This point is defined in the coordinate system of the unscaled page. If not specified, and scaling is requested, the <i>@ScalingOrigin</i> defaults to "0 0".
<i>FitPolicy</i> ? New in JDF 1.1	element	Allows printing even if the size of the imagable area of the media does not match the requirements of the data. This replaces the deprecated <i>@FitToPage</i> attribute. This <i>FitPolicy</i> resource SHALL be ignored in a combined process with LayoutPreparation .
<i>Media</i> * New in JDF 1.1 Modified in JDF 1.2	refelement	This resource provides a description of the physical media that will be marked. The physical characteristics of the media MAY affect decisions made during RasterReading . The cardinality was changed to "*" in JDF 1.2 in order to support description of multiple media types (e.g., Film, Plate and Paper). If multiple <i>Media</i> are specified, The <i>Media</i> / <i>@MediaType</i> defines the type of <i>Media</i> . If multiple <i>Media</i> with <i>Media</i> / <i>@MediaType</i> ="Paper" are specified in a proofing environment, the first <i>Media</i> is the proofer paper, while the second <i>Media</i> is the final device paper.

8.125 RegisterMark

Defines a register mark, which can be used for setting up and monitoring color registration in a printing process. It can also be used to synchronize the sheet position in a paper path. The position and rotation of each register mark can be specified with the help of the following attributes. It is important that the register marks are defined in such a way that their centers are on the point of origin of the coordinate system, as they are otherwise not positioned properly.

Resource Properties

Resource Class: Parameter

Resource referenced by: [HoleMakingParams](#), [Layout/MarkObject](#)

Table 8.230: RegisterMark Resource

NAME	DATA TYPE	DESCRIPTION
<i>Center</i>	XYPair	Position of the center of the register mark in the coordinates of the MarkObject that contains this mark.
<i>MarkType</i> ? Modified in JDF 1.4	NMTOKENS	Type of RegisterMark . Note: Marks can be combined to form a composite mark, see ▶ Figure 8-42: Combined MarkType. Values include those from: ▶ Table 8.231 MarkType Attribute Values. Modification note: Starting with JDF 1.4 , the data type changes from NMTOKEN to NMTOKENS.
<i>MarkUsage</i> ? New in JDF 1.1 Modified in JDF 1.4	enumerations	Specifies the usage of the RegisterMark . Allowed values are: Color – The mark is used for separation color registration. PaperPath – The mark is used for paper path synchronization. Tile – The mark is used to mark the position of tiles in Tiling . New in JDF 1.4
<i>Rotation</i> ?	double	Rotation in degrees. Positive graduation figures indicate counter-clockwise rotation; negative figures indicate clockwise rotation.
<i>SeparationSpec</i> * Modified in JDF 1.2	element	Set of separations to which the register mark is bound.

Table 8.231: MarkType Attribute Values

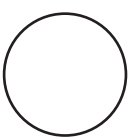
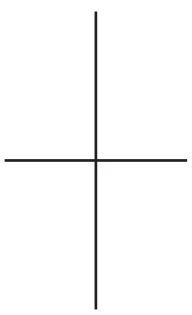
VALUE	DESCRIPTION
Arc	
Circle	
Cross	

8.125.0.1 Combined Register Mark

The following figure illustrates a combined **RegisterMark** consisting of an arc, a cross and a circle as well as the individual mark components.

Figure 8-42: Combined MarkType

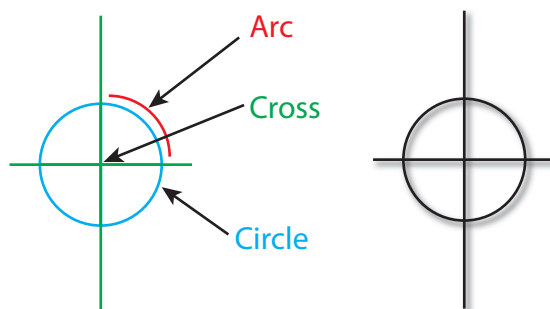

8.126 RenderingParams

This set of parameters identifies how the **Rendering** process SHALL operate. Specifically, these parameters define the expected output of the **ByteMap** resource that the **Rendering** process creates.

Resource Properties

Resource Class:	Parameter
Intent Pairing:	ProofingIntent
Example Partition:	"DocIndex", "RunIndex", "RunTags", "DocTags", "PageTags", "SetTags", "SheetName", "Side", "SignatureName"
Input of Processes:	Rendering

Table 8.232: RenderingParams Resource (Sheet 1 of 2)

NAME	DATA TYPE	DESCRIPTION
<i>BandHeight</i> ?	integer	Height of output bands expressed in lines. For a frame device, the band height is simply the full height of the frame.
<i>BandOrdering</i> ?	enumeration	Indicates whether output buffers are generated in "BandMajor" or "ColorMajor" order. Allowed values are: BandMajor – The position of the bands on the page is prioritized over the color. ColorMajor – All bands of a single color are played in order before progressing to the next plane. This is only possible with non-interleaved data.
<i>BandWidth</i> ?	integer	Width of output bands, in pixels.
<i>ColorantDepth</i> ?	integer	Number of bits per colorant. Determines whether the output is bitmaps or bytemaps.
<i>Interleaved</i> ?	boolean	If "true", the resulting colorant values SHALL be interleaved. @ <i>BandOrdering</i> SHALL NOT be specified if @ <i>Interleaved</i> ="true".
<i>MimeType</i> ? New in JDF 1.5	string	@ <i>MimeType</i> identifies the MIME type associated with this output file format. For example "application/pdf".
<i>AutomatedOverprintParams</i> ?	element	Controls for overprint substitutions. Defaults to no automated overprint generation.
<i>Media</i> ? New in JDF 1.1 Deprecated in JDF 1.2	refelement	This resource provides a description of the physical media that will be marked. The physical characteristics of the media MAY affect decisions made during Rendering . In JDF 1.2 and beyond, a RIP SHALL obtain Media information from InterpretingParams/Media .

Table 8.232: RenderingParams Resource (Sheet 2 of 2)

NAME	DATA TYPE	DESCRIPTION
ObjectResolution * Modified in JDF 1.2	element	Elements that define the resolutions at which to render the contents. More than one element MAY be used to specify different resolutions for different @SourceObjects types. If no ObjectResolution is specified, the value is implied from the input data.
TIFFFormatParams ? New in JDF 1.5	element	Parameters specific for creating TIFF files.

8.126.1 TIFFEmbeddedFile

New in JDF 1.2

Table 8.233: TIFFEmbeddedFile Element

NAME	DATA TYPE	DESCRIPTION
TagNumber	integer	Tag number of the specified tag (e.g., 34675 (decimal) for an ICC profile or 700 for XMP).
TagType	integer	The type of the tag as defined in ▶ [TIFF6]. This will usually be 1 (BYTE) or 7 (UNDEFINED).
FileSpec	refelement	Reference to the file that SHALL be embedded.

8.126.2 TIFFFormatParams

New in JDF 1.2

Table 8.234: TIFFFormatParams Element (Sheet 1 of 2)

NAME	DATA TYPE	DESCRIPTION
ByteOrder ?	enumeration	Byte order of the TIFF file. Allowed values are: ll – Low byte first. MM – High byte first. Note: The identifier values have been selected to match the identifier with the same purpose within the TIFF file itself.
Interleaving = "1"	integer	How the components of each pixel are stored. The values are taken from TIFF tag 284—PlanarConfiguration: Allowed values are: 1 – “Chunky” format, which is pixel interleaved. 2 – “Planar” format, which is strip interleaved.
RowsPerStrip ?	integer	The number of image scan lines per strip, encoded in the TIFF file as Row-sPerStrip. This attribute is ignored if @Segmentation!="Stripped". The default, if not known, is set by the processing system with the exception that when converting from ByteMap to TIFF, ByteMap/Band/@Height is the default.
Segmentation ?	enumeration	How the image data are segmented. Allowed values are: SingleStrip – All data are included in one segment. This is encoded in the TIFF file by setting RowsPerStrip to a number equal to or larger than the number of pixel rows in the image. Stripped – Data are segmented into strips. Tiled – Data are segmented into tiles.

Table 8.234: TIFFFormatParams Element (Sheet 2 of 2)

NAME	DATA TYPE	DESCRIPTION
<i>SeparationNameTag</i> = "270"	integer	When color separations are stored in individual TIFF files it is often useful to mark each with the name of the colorant that it represents, but there is no universally accepted way to do this. In order to avoid the need for explicit partitioning, the tag to be used to encode the separation name (as a string) can be entered here as the TIFF tag number. If the same TIFF tag number is also supplied as a TIFFtag subelement, then the TIFFtag element takes priority over <i>@SeparationNameTag</i> . The tag SHOULD only be put in the resulting TIFF files if the name of the separation is known. The default of "270" is the "TIFF" ImageDescription tag.
<i>TileSize</i> ?	XYPair	Two integers. The X value provides width of tiles, and the Y value provides height of tiles. <i>@TileSize</i> SHALL NOT be specified unless <i>@Segmentation</i> ="Tiled".
<i>WhitelsZero</i> = "true"	boolean	When writing monochrome or gray scale files, this flag indicates whether the data SHALL be written with either white values encoded as zero, "true" or black values encoded as zero, "false".
<i>TIFFEmbeddedFile</i> *	element	Files to be embedded within the created TIFF file. These might include an ICC profile, XMP data, etc.
<i>TIFFtag</i> *	element	Specific tag values for inclusion in the TIFF file.

The number of channels SHOULD be derived from the raster data to be converted.

When the **PhotometricInterpretation** tag = 5 and the **InkSet** tag = 2, it is strongly RECOMMENDED that the NumberOfInks and InkNames tags be completed—separation names MAY be obtained from the **ColorPool** resource .

Flate and JPEG compression in resulting TIFF files SHOULD use Compression = 8 and Compression = 7 respectively, as documented in ▶ [TIFFPS]. In particular, the JPEG encoding using Compression = 6, as described in ▶ [TIFF6] SHOULD NOT be used.

8.126.3 TIFFtag

New in JDF 1.2

Table 8.235: TIFFtag Element

NAME	DATA TYPE	DESCRIPTION
<i>BinaryValue</i> ?	hexBinary	If the type of the tag is UNDEFINED, then <i>@BinaryValue</i> is used to encode the data.
<i>IntegerValue</i> ?	IntegerList	If the type of the tag is BYTE, SHORT, LONG, SBYTE, SSHORT or SLONG, then <i>@IntegerValue</i> is used to encode that data.
<i>NumberValue</i> ?	DoubleList	If the type of the tag is RATIONAL, SRATIONAL, FLOAT or DOUBLE, then <i>@NumberValue</i> is used to encode that data.
<i>StringValue</i> ?	string	If the type of the tag is ASCII, then <i>@StringValue</i> is used to encode the data.
<i>TagNumber</i>	integer	Tag number of the specified tag (e.g., 270 (decimal) for ImageDescription).
<i>TagType</i>	integer	The type of the tag as defined in ▶ [TIFF6] (1 = BYTE, 2 = SHORT, etc.).

Exactly one of *@IntegerValue*, *@NumberValue*, *@StringValue* or *@BinaryValue* SHALL be present, depending on the type of the TIFF tag to be carried. **TIFFtag** elements SHALL NOT be used for any tags related to the image data and its encoding (ImageWidth, Compression, etc.). TIFFtag elements MAY include informational tags such as OPIProxy, ImageID, Copy-right, DateTime, ImageDescription, etc.

8.127 ResourceDefinitionParams

This set of parameters identifies how the **ResourceDefinition** process SHALL operate. Specifically, these parameters define how default parameters of applications and the input resource are to be combined.

Resource Properties

Resource Class: Parameter

Input of Processes: ResourceDefinition

Table 8.236: ResourceDefinitionParams Resource

NAME	DATA TYPE	DESCRIPTION
<i>DefaultID</i> ? Deprecated in JDF 1.1	NMTOKEN	JDF ID of the default resource. If missing, it is assumed that the file specified by <i>@DefaultJDF</i> contains only a JDF resource element, not a complete JDF .
<i>DefaultJDF</i> ?	URL	Link to a JDF resource that defines preset values.
<i>DefaultPriority</i> = "DefaultJDF"	enumeration	Defines whether preset values of the application or of the resource specified in <i>@DefaultJDF</i> have priority. Allowed values are from: ▶ DefaultPriority.
<i>ResourceParam</i> * New in JDF 1.1 Modified in JDF 1.3	element	Specification of the definition parameters of one individual resource.

8.127.1 ResourceParam

New in JDF 1.1

Table 8.237: ResourceParam Element

NAME	DATA TYPE	DESCRIPTION
<i>DefaultID</i> ?	NMTOKEN	<i>Resource</i> / <i>@ID</i> of the default resource. If missing, it is assumed that the file specified by <i>@DefaultJDF</i> contains only a JDF resource element, not a complete JDF .
<i>DefaultJDF</i> ?	URL	Link to a JDF resource that defines preset values. Defaults to the <i>@DefaultJDF</i> specified in <i>ResourceDefinitionParams</i> .
<i>DefaultPriority</i> ?	enumeration	Defines whether preset values of the application or of the resource specified in <i>@DefaultJDF</i> have priority. Default value is from: The parent's <i>ResourceDefinitionParams</i> / <i>@DefaultPriority</i> . Allowed values are from: ▶ DefaultPriority.

8.128 RingBindingParams

RingBindingParams describes the details of the **RingBinding** process.

Resource Properties

Resource Class: Parameter

Intent Pairing: BindingIntent

Input of Processes: RingBinding

Table 8.238: RingBindingParams Resource (Sheet 1 of 2)

NAME	DATA TYPE	DESCRIPTION
<i>BinderColor</i> ?	enumeration	Color of the ring binder. Allowed value is from: ▶ NamedColor.
<i>BinderColorDetails</i> ? New in JDF 1.4	string	A more specific, specialized or site-defined name for the color. If <i>@BinderColorDetails</i> is supplied, <i>@BinderColor</i> SHOULD also be supplied.
<i>BinderMaterial</i> ?	NMTOKEN	The following describe RingBinding binder materials used. Values include: Cardboard – Cardboard with no covering. ClothCovered – Cardboard with cloth covering. PVC – Solid PVC. PVCCovered – Cardboard with PVC covering.

Table 8.238: RingBindingParams Resource (Sheet 2 of 2)

NAME	DATA TYPE	DESCRIPTION
<i>BinderName</i> ?	string	The name of the binder manufacturer and the name of the specific item.
<i>RingDiameter</i> ?	double	Diameter of the rings, in points.
<i>RingMechanic</i> ?	boolean	If "true", a hand lever is available for opening.
<i>RingShape</i> ?	NMTOKEN	RingBinding values: Values include: Round Oval D-shape SlantD
<i>RingSystem</i> ? Deprecated in JDF 1.1	enumeration	Ring binding systems Allowed values are: 2HoleEuro – In Europe 3HoleUS – In North America 4HoleEuro – In Europe Deprecation note: Starting with JDF 1.2, use the value implied by HoleMakingParams/@HoleType .
<i>RivetsExposed</i> ?	boolean	The following RingBinding choice describes mounting of ring mechanism in binder case. If "true", the heads of the rivets are visible on the exterior of the binder. If "false", the binder covering material covers the rivet heads.
<i>SpineColor</i> ?	enumeration	Color of the binders spine. Allowed value is from: ▶ NamedColor.
<i>SpineColorDetails</i> ? New in JDF 1.4	string	A more specific, specialized or site-defined name for the color. If @SpineColorDetails is supplied, @SpineColor SHOULD also be supplied.
<i>SpineWidth</i> ?	double	The spine width is determined by the final height of the block of sheets to be bound.
<i>ViewBinder</i> ?	NMTOKEN	For RingBinding clear vinyl outer-wrap types on top of a colored base wrap: Values include: Embedded – Printed material is embedded by sealing between the colored and clear vinyl layers during the binder manufacturing. Pocket – Binder is designed so that printed material can be inserted between the color and clear vinyl layers after the binder is manufactured.
HoleMakingParams ? New in JDF 1.2	refelement	Details of the holes in RingBinding .

8.129 RollStand

New in JDF 1.2

Resource Properties

Resource Class: Handling

Input of Processes: **PrintRolling**

Table 8.239: RollStand Resource

NAME	DATA TYPE	DESCRIPTION
<i>MaxDiameter</i> ?	double	Maximal allowed diameter of the input component print roll.
<i>MaxWidth</i> ?	double	Maximal allowed width of the rolled input components.
<i>Device</i> ?	refelement	Further details of the RollStand .

8.130 RunList

A **RunList** defines one or more printable logical documents or document sets that MAY be defined in one or more external physical PDL or image files. It retains the properties of the original documents, e.g. the pages of a set of documents with ordered pages that are described by a **RunList**, retain that order.

RunList allows structuring of multiple pages into documents. Multiple documents that have a joint context may be grouped into sets. For examples of how these can be mapped see ▶ Section 8.130.1 Pages, Documents and Sets for common PDL types.

Resource Properties

Resource Class:	Parameter
Resource referenced by:	ArtDeliveryIntent/ArtDelivery, DigitalMedia, Layout/PageCondition, Layout/SheetCondition, PreflightReport
Example Partition:	"PartVersion", "Run", "RunPage", "RunSet", "Separation", "WebProduct"
Input of Processes:	AssetListCreation, ColorCorrection, ColorSpaceConversion, ContoneCalibration, CylinderLayoutPreparation, DigitalDelivery, DigitalPrinting, ImageReplacement, ImageSetting, Imposition, Interpreting, LayoutPreparation, LayoutShifting, PageAssigning, PDFToPSConversion, PDLCreation, Preflight, PreviewGeneration, PSToPDFConversion, RasterReading, Rendering, Screening, Separation, Stripping, Tiling, Trapping
Output of Processes:	AssetListCreation, ColorCorrection, ColorSpaceConversion, ContoneCalibration, DigitalDelivery, ImageReplacement, Imposition, Interpreting, LayoutElementProduction, LayoutPreparation, LayoutShifting, PageAssigning, PDFToPSConversion, PDLCreation, PSToPDFConversion, RasterReading, Rendering, Scanning, Screening, Separation, Stripping, Tiling, Trapping

Table 8.240: RunList Resource (Sheet 1 of 5)

NAME	DATA TYPE	DESCRIPTION
<i>Automation</i> ? New in JDF 1.5	enumeration	Identifies dynamic and static RunList elements. The structure of @PartIDKey generation for automated imposition is defined in detail in ▶ Section 6.3.18.3 Execution Model for Automated Imposition. This structure SHALL be retained in the RunList description. If @Automation="Dynamic" and Resource/@PipeID is also present, details MAY be specified in JMF pipe messages. See ▶ Section 4.3.3.1 Dynamic Pipes. Allowed value is from: ▶ Automation.
<i>ComponentGranularity="Document"</i> New in JDF 1.2 Deprecated in JDF 1.4	enumeration	Specifies which grouping of input LayoutElement PDL pages define the equivalent of an individual output Component instance for processing in a multi-document print job (e.g., in a variable data job). For instance, all pages defined between end-of-set markers would be stitched in a combined process node with DigitalPrinting and Stitching processes if @ComponentGranularity="Set" . Allowed values are: All – The complete RunList , regardless of document or set breaks, defines a new Component . BundleItem – An implicit PDL-defined document break or an explicit @EndOfBundleItem defines a new Component . Document – An implicit PDL-defined document break or an explicit @EndOfDocument defines a new Component . Page – Each page in the RunList defines a new Component . Set – Each set as defined by an implicit PDL-defined set break or an explicit @EndOfSet defines a new Component .
<i>Directory</i> ?	URL	Defines a directory where the files that are associated with this RunList are to be copied to or from. If @Directory is specified, it SHALL be an absolute URI ▶ [RFC3986] that implicitly also specifies a base URI which is used to resolve any relative URL of RunList . See ▶ Appendix J Resolving Directory URL References and ▶ [FileURL] for examples.

Table 8.240: RunList Resource (Sheet 2 of 5)

NAME	DATA TYPE	DESCRIPTION
<i>DocCopies</i> ="1" New in JDF 1.1	integer	Number of instance document copies that this <i>RunList</i> represents. Specifying <i>@DocCopies</i> is equivalent to repeating the sequence of <i>RunList</i> leaves between <i>@EndOfDocument</i> ="true" for a total of <i>@DocCopies</i> times. If <i>@DocCopies</i> is > 1 for an automated imposition job, the imposition engine places the equivalent <i>@DocCopies</i> attribute into the <i>RunList (Surface)</i> resource generated by the <i>Imposition</i> process. An exception is cut-and-stack imposition, where <i>@DocCopies</i> is applied by the imposition engine itself, and not placed into the <i>RunList(Surface)</i> . Note: It is illegal to specify <i>@DocCopies</i> with different values of various leaves of a <i>RunList</i> representing the same instance document.
<i>DocNames</i> ?	NameRange-List	A list of named documents in a multi-document file that supports named access to individual documents. The <i>@DocNames</i> defaults to all documents. If <i>@DocNames</i> occurs in the <i>RunList</i> , <i>@Docs</i> is ignored if it is also present.
<i>Docs</i> ?	NameRange-List	Zero-based list of document indices in a multi-document file specified by the <i>LayoutElement</i> resource. If not present, all documents SHALL be selected.
<i>EndOfBundleItem</i> ? New in JDF 1.2	boolean	If "true", the last page in the <i>RunList</i> is the last page of a <i>BundleItem</i> . The implied default value of <i>@EndOfBundleItem</i> ="false", except for the last <i>RunList</i> partition, which always has an implied default value of <i>@EndOfBundleItem</i> ="true". Modification note: Starting with JDF 1.4, this attribute no longer depends on the deprecated <i>@ComponentGranularity</i> .
<i>EndOfDocument</i> ?	boolean	If "true", the last page in the <i>RunList</i> is the last page of an instance document. Precisely how changes in the instance document are handled is defined in the <i>InsertSheet</i> resource. If the <i>RunList</i> references a PDL that supports internal instance documents, <i>@EndOfDocument</i> SHALL be the value that is defined in the PDL. The implied default value of <i>@EndOfDocument</i> ="false", except for the last <i>RunList</i> partition leaf, which always has an implied default value of <i>@EndOfDocument</i> ="true".
<i>EndOfSet</i> ? New in JDF 1.1	boolean	If "true", the last page in the <i>RunList</i> is the last page of a set of instance documents. Precisely how instance document boundaries are handled is defined in the <i>InsertSheet</i> resource. If the <i>RunList</i> references a PDL that supports internal sets, <i>@EndOfSet</i> SHALL be the value that is defined in the PDL. The implied default value of <i>@EndOfSet</i> ="false", except for the last <i>RunList</i> partition leaf, which always has an implied default value of <i>@EndOfSet</i> ="true".
<i>FinishedPages</i> ? New in JDF 1.6	integer	Number of finished page surfaces that one PDL page of this <i>RunList</i> refers to. This attribute SHOULD be used when cover spreads or imposed sheets that contain more than one reader page per PDL page are provided.
<i>FirstPage</i> ?	integer	First page in the document that is described by this <i>RunList</i> . This attribute is generally used to describe pre-separated files.
<i>IgnoreContext</i> ? New in JDF 1.4	enumerations	Specifies the <i>@PartIDKeys</i> values that do not affect the context in which this <i>RunList</i> is processed. Typically used when the <i>ResourceLink</i> is partitioned to re-order a content <i>RunList</i> . For the keys specified in this list, processing the <i>RunList</i> SHALL operate as if the identified parts represent the entire <i>RunList</i> . If partition keys are not specified, processing the <i>RunList</i> SHALL operate as if the entire <i>RunList</i> resource was processed, and all results removed except for those identified by the <i>ResourceLink</i> (e.g., for reprinting or recreating sheets with processing order-sensitive content - <i>@SheetIndex</i> has whatever value it would have had if sheets were generated using the entire, original <i>RunList</i>). See example just below this table.
<i>IsPage</i> ="true"	boolean	If "true", the individual <i>RunList</i> resource defines one or more page slots (e.g., for filling <i>PlacedObject</i> elements). If "false", the first parent partitioned <i>RunList</i> resource with <i>@IsPage</i> ="true" defines the page level. In general, <i>@IsPage</i> ="false" for separations of a pre-separated <i>RunList</i> .

Table 8.240: RunList Resource (Sheet 3 of 5)

NAME	DATA TYPE	DESCRIPTION
<i>LogicalPage</i> ? Modified in JDF 1.1	integer	The logical page number of the first page in a <i>RunList</i> . This attribute MAY be used to retain logical page indices when a partitioned <i>RunList</i> is spawned. It defaults to "1" plus the last page of the previous sibling <i>RunList</i> partition. If the <i>RunList</i> resource is the first partition, <i>@LogicalPage</i> defaults to "0". Note that is an error to specify <i>@LogicalPage</i> to be less than the number of previously defined logical pages in the same partition, since this defines overlapping pages within the <i>RunList</i> partition.
<i>NDoc</i> ? New in JDF 1.1 Deprecated in JDF 1.2	integer	Total number of instance documents that are defined by the <i>RunList</i> . If <i>@NDoc</i> is not specified, it defaults to all instance documents in the partitioned <i>RunList</i> elements that make up the <i>RunList</i> . In JDF 1.2 and beyond, only <i>@Docs</i> is supported.
<i>NPage</i> ?	integer	Total number of pages (placed object slots or <i>RunList</i> elements with <i>@IsPage="true"</i>) that are defined by the <i>RunList</i> . If <i>@NPage</i> is not specified, it defaults to all pages in the partitioned <i>RunList</i> elements that make up the <i>RunList</i> . If the <i>RunList</i> describes multiple instance documents or document sets, <i>@NPage</i> refers to the total number of pages in all instance documents and sets. A <i>RunList</i> with <i>@NPage</i> specified always refers to <i>@NPage</i> pages, regardless of the number of pages of the referenced PDL. If <i>@NPage</i> is not specified and no content is referenced, the <i>RunList</i> contains exactly one page.
<i>NSet</i> ? New in JDF 1.1 Deprecated in JDF 1.2	integer	Total number of instance document sets that are defined by the <i>RunList</i> . If <i>@NSet</i> is not specified, it defaults to all instance document sets in the partitioned <i>RunList</i> elements that make up the <i>RunList</i> . In JDF 1.2 and beyond, only <i>@Sets</i> is supported.
<i>PageCopies="1"</i> New in JDF 1.1	integer	Number of page copies that this <i>RunList</i> represents. Specifying <i>@PageCopies</i> is equivalent to repeating the <i>RunList</i> leaves representing each page for a total of <i>@PageCopies</i> times (e.g., a multiple represented by the value of <i>@PageCopies</i>). Note that pages specified by <i>@PageCopies</i> are always assumed uncollated when calculating the index in the logical <i>RunList</i> (e.g., <i>@PageCopies="2"</i> would result in a logical page sequence of 0 0 1 1 2 2, etc.).
<i>PageListIndex</i> ? New in JDF 1.2	IntegerRangeList	List of the indices of the <i>PageData</i> elements of the <i>PageList</i> specified in this <i>RunList</i> . If not specified, the complete <i>@PageListIndex</i> specified in this <i>RunList</i> is applied.
<i>PageNames</i> ?	NameRangeList	A list of named pages in a multi-page file that supports named access to individual pages. The <i>@PageNames</i> defaults to all pages. If <i>@PageNames</i> is specified, then <i>@FirstPage</i> , <i>@NPage</i> , <i>@SkipPage</i> and <i>@Pages</i> SHALL all be ignored if any is specified.
<i>Pages</i> ?	IntegerRangeList	Zero-based list of indices in the documents specified by the <i>LayoutElement</i> resource and the <i>@Docs</i> , <i>@DocNames</i> , <i>@Sets</i> and <i>@SetNames</i> attributes. The <i>@Pages</i> need not be in document order. If <i>@Pages</i> is specified, <i>@FirstPage</i> and <i>@SkipPage</i> SHALL be ignored. If none of <i>@Pages</i> , <i>@FirstPage</i> , <i>@NPage</i> , <i>@PageNames</i> or <i>@SkipPage</i> is specified, all pages (i.e., "0 ~ -1") referred to by the <i>RunList</i> SHALL be selected. Modification note: Before JDF 1.4 , <i>LayoutElement</i> appeared in place of <i>RunList</i> in the preceding sentence.
<i>RunTag</i> ? New in JDF 1.1	NMTOKEN	Tag of a partition of a resource other than the <i>RunList</i> which is partitioned by <i>@RunTags</i> . The partition matches if any of the entries in the <i>@RunTags</i> list matches <i>@RunTag</i> . Multiple entries in a <i>RunList</i> MAY have the same <i>@RunTag</i> . If the <i>RunList</i> references a PDL that supports internal labels, <i>@RunTag</i> MAY be implied from the PDL.

Table 8.240: RunList Resource (Sheet 4 of 5)

NAME	DATA TYPE	DESCRIPTION
<p><i>SetCopies</i>="1" New in JDF 1.1</p>	integer	<p>Number of instance document set copies that this <i>RunList</i> represents. Specifying <i>@SetCopies</i> is equivalent to repeating the sequence of <i>RunList</i> leaves between <i>@EndOfSet</i>="true" for a total of <i>@SetCopies</i> times.</p> <p>If <i>@SetCopies</i> is > 1 for an automated imposition job, the imposition engine places the equivalent <i>@SetCopies</i> attribute into the <i>RunList</i> (<i>Surface</i>) resource generated by the <i>Imposition</i> process. An exception is cut-and-stack imposition, where <i>@SetCopies</i> is applied by the imposition engine itself, and not placed into the <i>RunList</i> (<i>Surface</i>).</p> <p>Note: It is illegal to specify <i>@SetCopies</i> with different values of various leaves of a <i>RunList</i> representing the same instance document.</p>
<p><i>SetNames</i> ? New in JDF 1.1</p>	NameRange-List	<p>A list of named document sets in a multi-document set file that supports named access to individual documents. The <i>@SetNames</i> defaults to all document sets specified by <i>@Sets</i>. If <i>@SetNames</i> occurs in the <i>RunList</i>, <i>@Sets</i> is ignored if it is also present.</p> <p><i>@SetNames</i> is only valid if <i>LayoutElement</i>/<i>@ElementType</i>="MultiSet".</p>
<p><i>Sets</i> ? New in JDF 1.1</p>	IntegerRangeList	<p>Zero based list of document-set indices in a multi document-set file specified by the <i>LayoutElement</i> resource. If not present, all document sets SHALL be selected.</p> <p><i>@Sets</i> is only valid if <i>LayoutElement</i>/<i>@ElementType</i>="MultiSet".</p>
<p><i>SheetSides</i> ? New in JDF 1.4</p>	enumeration	<p>Specifies the binding of surfaces referenced by this <i>RunList</i> to sheets. SHALL only be specified in <i>RunList</i> (<i>Surface</i>).</p> <p>Allowed values are:</p> <p>Front – all surfaces referenced from a <i>RunList</i> leaf partition describe one or more front sides of successive sheets, with implicit back blank sides.</p> <p>Back – all surfaces referenced from a <i>RunList</i> leaf partition describe one or more back sides of successive sheets, with implicit front blank sides.</p> <p>FrontBack – all surfaces referenced from a <i>RunList</i> leaf partition describe a succession of sheets, where for each sheet a front is followed by a back surface.</p> <p>BackFront – all surfaces referenced from a <i>RunList</i> leaf partition describe a succession of sheets, where for each sheet a back is followed by a front surface.</p>
<p><i>SkipPage</i> ?</p>	integer	<p>Used when the <i>RunList</i> comprises every Nth page of the file. <i>@SkipPage</i> indicates the number of pages to be skipped between each of the pages that comprise the <i>RunList</i> resource. This is generally used to describe pre-separated files, or to select only even or odd pages. Note that <i>@SkipPage</i> is, therefore, 3 (4 Separations -> skip 3) in a CMYK separated file.</p>
<p><i>Sorted</i> ?</p>	boolean	<p>Specifies whether the elements in the <i>RunList</i> are sorted in the document reader order.</p>
<p><i>ByteMap</i> ? Modified in JDF 1.2</p>	refelement	<p>Describes the page or stream of pages. At most one of <i>ByteMap</i>, <i>InterpretedPDLDATA</i> or <i>LayoutElement</i> SHALL be specified. If none of <i>ByteMap</i>, <i>InterpretedPDLDATA</i> or <i>LayoutElement</i> are specified, the <i>RunList</i> specifies empty content.</p>
<p><i>Disposition</i> ?</p>	element	<p>Indicates what the device SHOULD do with the file when the process that uses this resource completes. If not specified, the file specified by this <i>RunList</i> is retained indefinitely. <i>RunList</i>/<i>LayoutElement</i>/<i>FileSpec</i>/<i>Disposition</i> takes precedence over <i>RunList</i>/<i>Disposition</i>.</p> <p>Modification note: Starting with JDF 1.4, "this <i>RunList</i>" above replaces "this <i>FileSpec</i>".</p>

Table 8.240: RunList Resource (Sheet 5 of 5)

NAME	DATA TYPE	DESCRIPTION
DynamicInput * Deprecated in JDF 1.4	element	Replacement text for a DynamicField element. This information defines the contents of a dynamic mark on the automated page layout (see ▶ Section 8.84.10.1 Dynamic Marks). The mark SHALL be filled using information from the document RunList (e.g., the bar code of the recipient). This information varies with the document content. DynamicInput elements have one OPTIONAL @Name attribute that, when linked to the @ReplaceField attribute of the DynamicField element, defines the string that SHALL be replaced. Deprecation note: Starting with JDF 1.4 , metadata should be extracted from the PDL itself or from other sources, but not from the RunList . DynamicInput was designed to associates metadata with RunList elements.
InsertSheet *	element	Describes how sheets and surfaces are to be completed and OPTIONAL media which MAY be inserted at the beginning or end of this RunList resource.
InterpretedPDLData ? New in JDF 1.2	refelement	Represents the results of the PDL interpretation process. At most one of ByteMap , InterpretedPDLData or LayoutElement SHALL be specified. If none of ByteMap , InterpretedPDLData or LayoutElement are specified, the RunList specifies empty content.
LayoutElement ? Modified in JDF 1.2	refelement	Describes the document, page or image. At most one of ByteMap , InterpretedPDLData or LayoutElement SHALL be specified. If none of ByteMap , InterpretedPDLData or LayoutElement are specified, the RunList specifies empty content.
MetadataMap *	element	Describes the mapping of metadata in a RunList to @PartIDKeys . MetadataMap SHOULD NOT be specified unless @Automation="Dynamic" .
PageList ?	refelement	Specification of page metadata for pages described by this RunList .

8.130.1 Pages, Documents and Sets for common PDL types

The following table defines the mapping of **RunList** structures to commonly used PDLs.

Table 8.241: Pages, Documents and Sets for common PDL types

PDL	PAGES	DOCUMENTS	SETS	REMARKS
Post-Script	-	-	PostScript is a single document PDL	
PDF	Page in pages tree	-	-	Regular PDF including PDF/X is a single document PDL
PDF/VT	Page in pages tree	Any DPart Descendant below the Set	Any DPart record as defined by RecordLevel	A Record as defined by Record-Level SHALL be mapped to a Set
PPML	PAGE elements	DOCUMENT elements	DOCUMENT_SET/JOB elements	

Example 8.44: Marks and Reordering of Content using RunList/@IgnoreContext

New in JDF 1.4

Assume that a VDP job consists of sets where each set contains a cover letter, brochure, and postcard document types. Production needs all of each document type for all sets printed first, and the imposition includes dynamic marks where some of the marking uses **@SheetIndex**. The **RunListLink** parameterizes the processing such that all Cover Letter sheets for all sets are processed first, followed by the brochure sheets for all sets, and finally, the Postcard sheets for all sets.

The **RunList** then specifies `@IgnoreContext="SheetIndex"`, which forces the `@SheetIndex` to be calculated in the order in which sheets are produced by the processing of the reordered “virtual” **RunList**.

```
<ResourcePool>
  <RunList Class="Parameter" ID="MyVDPRunList"
    IgnoreContext="SheetIndex" PartIDKeys="DocTags" Status="Available">
    <!-- additional attributes and elements -->
    <RunList DocTags="CoverLetter"/>
    <RunList DocTags="Brochure"/>
    <RunList DocTags="Postcard"/>
  </RunList>
</ResourcePool>
<ResourceLinkPool>
  <RunListLink Usage="Input" rRef="MyVDPRunList">
    <Part DocTags="CoverLetter"/>
    <Part DocTags="Brochure"/>
    <Part DocTags="Postcard"/>
  </RunListLink>
</ResourceLinkPool>
```

To enable later reprinting of part of the **RunList**, the **RunList** then might also specify a **MetadataMap** element that extracts the value of a RecordNumber metadata key and assigns the value to `@Metadata0`. Subsequently, if record # 12 needs re-printing, the **RunListLink** can be modified to appear as:

```
<RunListLink ProcessUsage="Document" Usage="Input" rRef="MyVDPRunList">
  <Part DocTags="CoverLetter" Metadata0="12"/>
  <Part DocTags="Brochure" Metadata0="12"/>
  <Part DocTags="Postcard" Metadata0="12"/>
</RunListLink>
```

8.130.2 DynamicInput

Deprecated in JDF 1.4

Example 8.45: RunList: Unstructured Single-File RunList

The following examples illustrate how a **RunList** can be structured using partitioning mechanisms. Note that the partitioning of a **RunList** often generates the values necessary to evaluate the partitioning of other resources (e.g., the `@RunIndex` into the **RunList**). Thus, the order in which the **RunList** elements appear in the XML document is significant. **Note:** The `@Run` partition key has a string value, which MAY be non-numeric. Below is an example of a simple unstructured single-file **RunList**. This example specifies all pages contained in `"/in/colortest.pdf"`.

```
<RunList Class="Parameter" ID="Link0003" Pages="0 ~ -1" Status="Available">
  <LayoutElement>
    <FileSpec URL="File:///in/colortest.pdf"/>
  </LayoutElement>
</RunList>
```

Example 8.46: RunList: Multi-File Unseparated RunList

Example of simple multi-file unseparated **RunList** using **RunList/@Directory**. This example specifies all pages contained in `File1.pdf` and `File2.pdf`, which are located in the directory `"/in/Dir/"` that is specified in **RunList/@Directory**.

```
<RunList Class="Parameter" Directory="File:///Dir/" ID="Link0003"
  PartIDKeys="Run" Status="Available">
  <RunList Pages="0 ~ -1" Run="1">
    <LayoutElement>
      <FileSpec URL="File1.pdf"/>
    </LayoutElement>
  </RunList>
  <RunList Pages="0 ~ -1" Run="2">
    <LayoutElement>
      <FileSpec URL="File2.pdf"/>
    </LayoutElement>
  </RunList>
</RunList>
```

Example 8.47: RunList: Multi-File Unseparated RunList with Spawning

Example of simple multi-file unseparated **RunList** with independent spawning. This example specifies the first five pages contained in File1.pdf and File2.pdf. File2.pdf has been spawned and is being processed individually.

```
<RunList Class="Parameter" ID="Link0003" PartIDKeys="Run" Status="Available">
  <RunList Pages="0 ~ 4" Run="1">
    <LayoutElement>
      <FileSpec URL="File:///File1.pdf"/>
    </LayoutElement>
  </RunList>
  <RunList Pages="0 ~ -1" Run="2" SpawnStatus="SpawnedRW">
    <LayoutElement>
      <FileSpec URL="File:///File2.pdf"/>
    </LayoutElement>
  </RunList>
</RunList>
```

Example 8.48: RunList: Spawned RunList

This is the corresponding spawned **RunList**. Note the `@LogicalPage` attribute, which specifies the number of skipped pages.

```
<RunList Class="Parameter" ID="Link0003" LogicalPage="5"
  Pages="0 ~ -1" PartIDKeys="Run" Status="Available">
  <RunList Run="2">
    <LayoutElement>
      <FileSpec URL="File:///File2.pdf"/>
    </LayoutElement>
  </RunList>
</RunList>
```

Example 8.49: RunList: Multi-File Separated RunList

This example specifies all pages contained in Presep.pdf and following that, pages 1, 3 and 5 of each pre-separated file.

```
<RunList Class="Parameter" ID="Link0003" PartIDKeys="Run Separation" Status="Available">
  <RunList Run="1" SkipPage="3">
    <LayoutElement>
      <FileSpec URL="File:///Presep.pdf"/>
    </LayoutElement>
    <RunList FirstPage="0" IsPage="false" Separation="Cyan"/>
    <RunList FirstPage="1" IsPage="false" Separation="Magenta"/>
    <RunList FirstPage="2" IsPage="false" Separation="Yellow"/>
    <RunList FirstPage="3" IsPage="false" Separation="Black"/>
  </RunList>
  <RunList IsPage="true" Pages="1 3 5" Run="2">
    <RunList IsPage="false" Separation="Cyan">
      <LayoutElement>
        <FileSpec URL="File:///Cyan2.pdf"/>
      </LayoutElement>
    </RunList>
    <RunList IsPage="false" Separation="Magenta">
      <LayoutElement>
        <FileSpec URL="File:///Magenta2.pdf"/>
      </LayoutElement>
    </RunList>
    <RunList IsPage="false" Separation="Yellow">
      <LayoutElement>
        <FileSpec URL="File:///Yellow2.pdf"/>
      </LayoutElement>
    </RunList>
    <RunList IsPage="false" Separation="Black">
      <LayoutElement>
        <FileSpec URL="File:///Black2.pdf"/>
      </LayoutElement>
    </RunList>
  </RunList>
</RunList>
```

8.131 SaddleStitchingParams

Deprecated in JDF 1.1

8.132 ScanParams

ScanParams provides the parameters for the **Scanning** process.

Resource Properties

Resource Class: Parameter
 Resource referenced by: [ArtDeliveryIntent/ArtDelivery](#)
 Example Partition: "RunIndex"
 Input of Processes: **Scanning**

Table 8.242: ScanParams Resource (Sheet 1 of 2)

NAME	DATA TYPE	DESCRIPTION
<i>BitDepth</i>	integer	Bit depth of a one-color separation.
<i>CompressionFilter</i> ?	enumeration	Specifies the compression filter to be used. Allowed values are: CCITTFaxEncode – Used to select CCITT Group 3 or 4 facsimile encoding. DCTEncode – Used to select JPEG compression. FlateEncode – Used to select zip compression. WaveletEncode – Used to select Wavelet compression. JBIG2Encode – Used to select JBIG2 monochrome compression.

Table 8.242: ScanParams Resource (Sheet 2 of 2)

NAME	DATA TYPE	DESCRIPTION
<i>DCTQuality</i> ?	double	A value between 0 and 1 that indicates “how much” the process SHALL compress images. 0.0 means “do as loss-less compression as possible.” 1.0 means “do the maximum compression possible.”
<i>InputBox</i> ?	rectangle	Rectangle that describes the image section to be scanned, in points. The origin of the coordinate system is the lower left corner of the physical item to be scanned.
<i>Magnification</i> = "1 1"	XYPair	Size of the output/size of the input for each dimension.
<i>MountID</i> ?	string	ID of the drum or other mounting device upon which the media SHALL be mounted.
<i>Mounting</i> ?	enumeration	Specifies how to mount originals. Allowed values are: Unfixed – Original lies unfixed on the scanner tray/drum. Fixed – Original is fixed on the scanner tray/drum with transparent tape. Wet – Original is put in gel or oil and fixed on the scanner tray/drum. Registered – Original is fixed with registration holes. This value is used for copy dot scans.
<i>OutputColorSpace</i>	enumeration	Color space of the output images. Allowed values are: LAB RGB CMYK GrayScale
<i>OutputResolution</i>	XYPair	X and Y resolution of the output bitmap, in dpi.
<i>OutputSize</i> ?	XYPair	X and Y dimension of the intended output image, in points.
<i>SplitDocuments</i> ?	integer	A number representing how many images are scanned before a new file is created.
<i>FileSpec</i> (<i>CorrectionProfile</i>) ?	reference	A <i>FileSpec</i> resource pointing to an ICC profile that describes color corrections.
<i>FileSpec</i> (<i>ScanProfile</i>) ?	reference	A <i>FileSpec</i> resource pointing to an ICC profile that describes the scanner.
<i>FileSpec</i> (<i>TargetProfile</i>) ?	reference	A <i>FileSpec</i> resource pointing to an ICC profile that defines the target output device for a device specific scan (e.g., the profile of a CMYK press).

8.133 ScavengerArea

New in JDF 1.1

ScavengerArea describes a scavenger area for removing excess ink from printed sheets. It is defined within a **MarkObject** of a surface.

Resource Properties

Resource Class: Parameter

Resource referenced by: **Layout/MarkObject**

Table 8.243: ScavengerArea Resource (Sheet 1 of 2)

NAME	DATA TYPE	DESCRIPTION
<i>Center</i>	XYPair	Position of the center of the scavenger area in the coordinates of the MarkObject that contains this mark.
<i>Rotation</i> ?	double	Rotation in degrees. Positive graduation figures indicate counter-clockwise rotation; negative figures indicate clockwise rotation.

Table 8.243: ScavengerArea Resource (Sheet 2 of 2)

NAME	DATA TYPE	DESCRIPTION
<i>Size</i>	XYPair	Size of the scavenger area.
SeparationSpec * Modified in JDF 1.2	element	Set of separations to which the scavenger area is bound.

8.134 ScreeningParams

ScreeningParams specifies the parameters of the **Screening** process. Since screening is, in most cases, very OEM specific, the following parameters are generic enough that they can be mapped onto a number of OEM controls.

Resource Properties

Resource Class: Parameter

Resource referenced by: **ContactCopyParams**, **ContentList/ContentData**, **ExposedMedia**, **LayoutElement**, **PageList**, **PageList/PageData**, **RunList**

Intent Pairing: **ProofingIntent**, **ScreeningIntent**

Example Partition: "Separation", "SheetName", "Side", "SignatureName"

Input of Processes: **ContoneCalibration**, **Screening**

Table 8.244: ScreeningParams Resource

NAME	DATA TYPE	DESCRIPTION
<i>AbortJobWhenScreenMatchingFails?</i> Deprecated in JDF 1.2	boolean	Specifies what happens when the device can not fulfill the screening requests. If "true", it flushes the job. If "false", it ignores matching errors using the default screening. Use @SettingsPolicy in JDF 1.2 and beyond.
<i>IgnoreSourceFile = "true"</i>	boolean	If @IgnoreSourceFile="true" , the screen settings specified in a source file SHALL NOT be applied, e.g. setscreen , setcolorscreen and sethalftone in a PDF file. Note: In some cases, halftones are used to create patterns. In these cases, the halftone in the source PDL file will not be overridden.
ScreenSelector *	element	List of screen selectors. A screen selector is included for each separation, including a default specification. ScreenSelector SHALL contain the complete set of parameters for a given screening operation. For instance, it is invalid to specify one ScreenSelector for a given @ObjectTags and another ScreenSelector for a given @SourceObjects .

8.135 SeparationControlParams

SeparationControlParams provides the controls needed to separate composite color files.

Resource Properties

Resource Class: Parameter

Intent Pairing: **ProofingIntent**, **ScreeningIntent**

Input of Processes: **Separation**

Table 8.245: SeparationControlParams Resource

NAME	DATA TYPE	DESCRIPTION
<i>AutomatedOverprintParams?</i>	element	Controls for overprint substitutions. The default case is that no automated overprint generation is used.
<i>TransferFunctionControl?</i>	refelement	Controls whether the device performs transfer functions and what values are used when doing so.

8.136 Shape

Resource Properties

Resource Class: Parameter

RESOURCES

Resource referenced by: [ShapeCuttingParams](#), [ShapeDef](#)

Table 8.246: Shape Resource

NAME	DATA TYPE	DESCRIPTION
CutBox ?	rectangle	Specification of a rectangular window.
CutOut="false"	boolean	If "true", the inside of a specified shape will be removed. If "false", the outside of a specified shape will be removed. An example of an inside shape is a window. An example of an outside shape is a shaped greeting card.
CutPath ?	PDFPath	Specification of a complex path. This MAY be an open path in the case of a single line.
CutType="Cut" Deprecated in JDF 1.4	enumeration	Type of cut or perforation used. Allowed values are: Cut – Full cut. Perforate – Interrupted perforation that does not span the entire sheet
DDESCutType="101" New in JDF 1.4	integer	Type of cut or perforation used. Values include: a number between "0" and "999" corresponding to a line type as defined in DDES3 standard (ANSI® IT8.6–2002). Note: The default value 101 corresponds to a cut line.
Material ?	string	Transparent material that fills a shape (e.g., an envelope window) that was cut out when @CutOut="true" .
ShapeDepth ?	double	Depth of the shape cut, measured in microns [µm]. If not specified, the shape is completely cut.
ShapeType	enumeration	Describes any precision cutting other than hole making. Allowed values are: Path Rectangular Round RoundedRectangle – Rectangle with rounded corners. New in JDF 1.3
StationName ? New in JDF 1.3 Deprecated in JDF 1.4	string	The name of the 1-up design in the die layout. Used to match DieLayout/Station elements with Shape elements.
TeethPerDimension ?	double	Number of teeth in a given perforation extent, in teeth/point. MicroPerforation is defined by specifying a large number of teeth (n > 1000).

8.137 ShapeCuttingParams

New in JDF 1.1

[ShapeCuttingParams](#) defines the details of the [ShapeCutting](#) process.

Resource Properties

Resource Class: [Parameter](#)

Intent Pairing: [ShapeCuttingIntent](#)

Input of Processes: **ShapeCutting**

Table 8.247: ShapeCuttingParams Resource

NAME	DATA TYPE	DESCRIPTION
DeliveryMode ? New in JDF 1.3	enumeration	Allowed values are: FullSheet – The output of the die-cutter SHALL be complete sheets. The blanks are kept in place with nicks. Front waste (gripper margin) SHALL NOT be removed. RemoveGripperMargin – The output of the die-cutter SHALL be complete sheets. The blanks are kept in place with nicks. Front waste (gripper margin) SHALL be removed. SeparateBlanks – The output of the die-cutter SHALL be blanks that have been removed from the sheets.
ModuleIndex ? New in JDF 1.4	integer	Index of the shape-cutting module in a multi-function device, such as a printing press. See Module for details. In a combined process, all modules of the device, including press modules, finishing modules and varnishing modules are counted to calculate @ModuleIndex .
SheetLay ? New in JDF 1.3	enumeration	Lay of input media. Reference edge of where the sheets are placed in the feeder. Allowed value is from: ▶ SheetLay .
DieLayout ? New in JDF 1.3	reference	A resource containing the reference of an external file describing the cutting and other paths.
Shape *	reference	Details of each individual cut shape.

8.138 ShapeDef

New in JDF 1.4

A structural design describing a 2D surface with paths that describe different finishing operations such as cutting, creasing, perforation, etc. In the case of box production this resource is a description of the unprinted blank box as it will be available after die cutting and blanking and before folding. A [ShapeDef](#) is defined either by an external file ([FileSpec](#)) describing the structural design or a collection of PDFPaths contained in [Shape](#) elements. In case this description is stored in a file, the format of this file may be a vendor specific format, a standard ▶ [DDES3], or less well specified but commonly used formats like CFF2 or DXF or even a PDF or EPS file.

Resource Properties

Resource Class: **Parameter**Resource referenced by: [DieLayout/Station](#), [LayoutElementProductionParams](#)Input of Processes: **DieLayoutProduction**Output of Processes: **ShapeDefProduction**

Table 8.248: ShapeDef Resource (Sheet 1 of 2)

NAME	DATA TYPE	DESCRIPTION
Area ?	double	The net area of the shape in m ² , after cutting.
CutBox ?	rectangle	A rectangle describing the bounding box of all cut lines. This is sometimes referred to as the knife to knife dimensions of a blank box. This attribute is usually only valid after the generation of the structural design.
Dimensions ?	shape	Width x, height y and depth z coordinates of the open 3D shape. For a box, these are the outer dimensions of the opened and potentially filled box (e.g., for palletizing of the final products). Note: Compare with @FlatDimensions .
FlatDimensions ? New in JDF 1.5	shape	Width x, height y and depth z coordinates of the flat 3D shape. For a box, these are the outer dimensions of the glued flat box (e.g., for palletizing of the boxes prior to filling). This corresponds to Component/@Dimensions of the output of the BoxFolding process. Note: Compare with @Dimensions .

Table 8.248: ShapeDef Resource (Sheet 2 of 2)

NAME	DATA TYPE	DESCRIPTION
<i>FluteDirection</i> ?	enumeration	Intended direction of the flute for this design in the coordinate system defined by @CutBox. This information SHALL be taken into account by the DieLayoutProduction process to give the ShapeDef the correct orientation on the sheet. Allowed value is from: ▶ MediaDirection.
<i>GrainDirection</i> ?	enumeration	Intended direction of the grain for this design in the coordinate system defined by @CutBox. This information SHALL be taken into account by the DieLayoutProduction process to give the ShapeDef the correct orientation on the sheet. Allowed value is from: ▶ MediaDirection.
<i>MediaSide</i> ?	enumeration	Determines the printing side for which the DieLayout is made. "Front" corresponds to the outside of a box, "Back" corresponds to the inside of a box. Allowed value is from: ▶ Side. Note: Folding carton is usually cut from the outside (Front), corrugated from the inside (Back).
<i>ResourceWeight</i> ?	double	The weight of the shape after cutting (g).
<i>ColorPool</i> ? New in JDF 1.5	refelement	The ColorPool that SHOULD contain names and further details of the separations used in CutLines.
<i>CutLines</i> ? New in JDF 1.5	element	Selects the die line separations from the file referenced by FileSpec. Additional details of the usage of the separations MAY be specified in the respective ColorPool/Color elements.
<i>FileSpec</i> ?	refelement	The FileSpec of the structural design file. The format of this file may be a vendor specific format, a standard format like ▶ [DDES3], a less well specified but commonly used format like CFF2 or DXF or even a PDF or EPS file. FileSpec and Shape are mutually exclusive.
<i>Media</i> ?	refelement	Media for which this structural design was intended for. The Media description defines important design parameters as the type of Media, thickness, inside loss, outside gain, etc. Media/@GrainDirection and Media/@FluteDirection do not have any significance.
<i>Shape</i> *	refelement	The shape is defined by a collection of Shape elements. Shape and FileSpec are mutually exclusive.

8.139 ShapeDefProductionParams

New in JDF 1.4

Parameters for the structural design.

Resource Properties

Resource Class: Parameter

Input of Processes: ShapeDefProduction

Table 8.249: ShapeDefProductionParams Resource

NAME	DATA TYPE	DESCRIPTION
<i>ObjectModel</i> *	element	A 3D model of the objects that need to be packed.
<i>ShapeTemplate</i> ?	element	A structural template sometimes referred to as a parametric structural design. Given a set of parametric values, a structural template can be instantiated to an actual structural design.

8.139.1 ObjectModel

New in JDF 1.4

Table 8.250: ObjectModel Element

NAME	DATA TYPE	DESCRIPTION
<i>Dimensions</i> ?	shape	Width <i>x</i> , height <i>y</i> and depth <i>z</i> values for the bounding box of the object.
<i>FileSpec</i> ?	refelement	The <i>FileSpec</i> of the 3D model of the objects that needs to be packed. The format of this file MAY be a vendor specific format or a standard 3D format like VRML or PDF (U3D).

8.139.2 ShapeTemplate

New in JDF 1.4

Additional parametric values SHALL be specified with *GeneralID* elements. *GeneralID*/*@IDUsage* SHALL be set to the name of the parameter. *GeneralID*/*@DataType* SHALL be set to "double". *GeneralID*/*@IDValue* SHALL be set to value of the parameter.

Table 8.251: ShapeTemplate Element

NAME	DATA TYPE	DESCRIPTION
<i>InnerDimensions</i> ?	shape	Width <i>x</i> , height <i>y</i> and depth <i>z</i> coordinates of the 3D shape. For a box these are the inner dimensions.
<i>Name</i> ?	string	The name of a parametric structural design or CAD template.
<i>Standard</i> ?	string	The name of the standard this template belongs to (e.g., FEFCO, ECMA or the name of a company internal standard).
<i>FileSpec</i> ?	refelement	The <i>FileSpec</i> of the parametric structural design.

The three figures below show shapes specified by a *ShapeTemplate* with each named variable represented by a *GeneralID* that specifies the name and value of the variable. The *ShapeTemplate* for the diagram below might be: .

Example 8.50: ShapeTemplate for template example 1

```
<ShapeDefProductionParams Class="Parameter" ID="Link0003" Status="Available">
  <ShapeTemplate>
    <GeneralID DataType="double" IDUsage="L" IDValue="1440.0"/>
    <GeneralID DataType="double" IDUsage="W" IDValue="720.0"/>
    <GeneralID DataType="double" IDUsage="D" IDValue="1440.0"/>
  </ShapeTemplate>
</ShapeDefProductionParams>
```

Figure 8-43: ShapeTemplate example 1

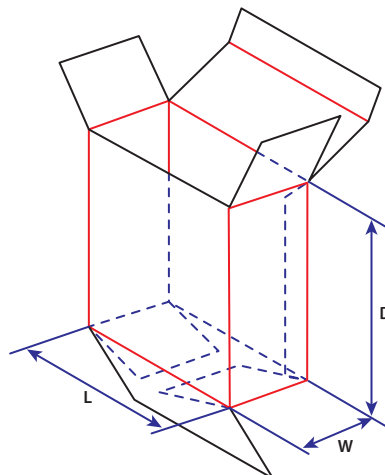

Figure 8-44: ShapeTemplate example 2

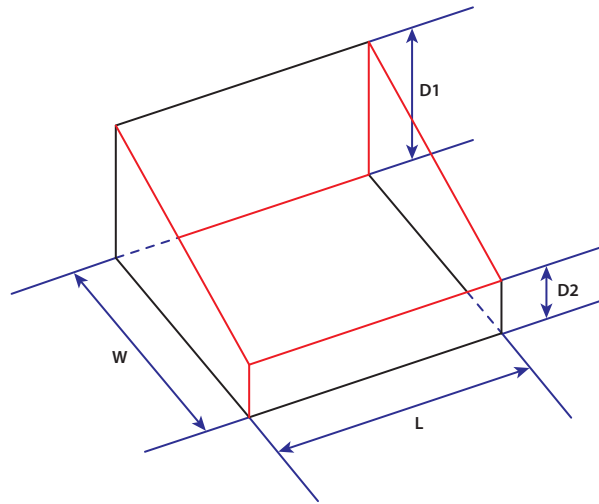
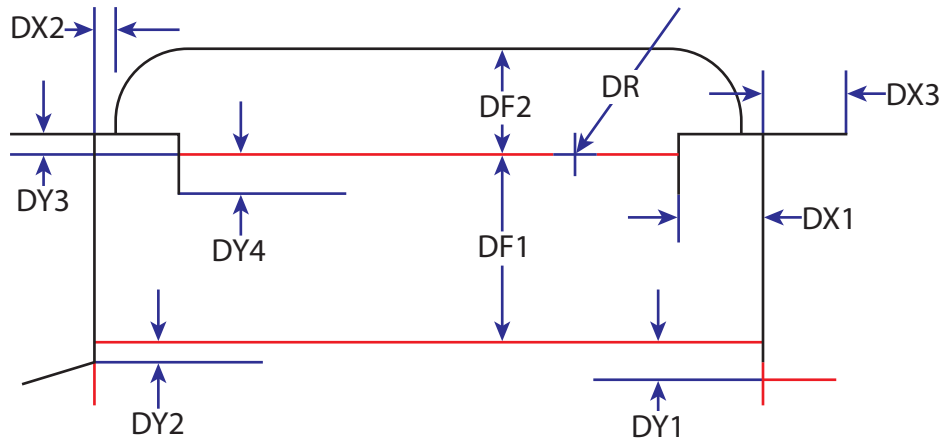

Figure 8-45: ShapeTemplate example 3



8.140 Sheet

Deprecated in JDF 1.3

Sheet provides a description of a sheet, as well as the marks on that sheet. In **JDF 1.3** and beyond, a sheet is represented as a **Layout** partition, namely **Layout[@SheetName]**. For details, see ▶ Section 8.84 Layout.

8.141 SheetOptimizingParams

New in JDF 1.5

SheetOptimizingParams describes the parameter set for the **SheetOptimizing** process.

Resource Properties

Resource Class: Parameter

Input of Processes: **SheetOptimizing**

Table 8.252: SheetOptimizingParams Resource (Sheet 1 of 2) (Sheet 1 of 2)

NAME	DATA TYPE	DESCRIPTION
ConvertingConfig +	element	Specification of the device configurations for destination sheet sizes.

Table 8.252: SheetOptimizingParams Resource (Sheet 2 of 2) (Sheet 2 of 2)

NAME	DATA TYPE	DESCRIPTION
GangElement +	element	Each GangElement describes an individual product or product part that SHALL be placed completely on a gang form. If an individual product MAY be distributed over multiple separate gangs (e.g., cover and body with different paper), it SHALL be represented as multiple gang elements.

8.141.1 GangElement

New in JDF 1.5

A **GangElement** describes an individual product or product part (e.g., product cover) that is a candidate for placement on a printed sheet.

Table 8.253: GangElement Element (Sheet 1 of 2)

NAME	DATA TYPE	DESCRIPTION
AssemblyIDs ?	NMTOKENS	The @AssemblyIDs of the StrippingParams partitions that may be ganged. Any StrippingParams partitions in the GangElement that have an assembly ID that is not in this list SHALL NOT be ganged. If not specified all partitions are selected.
CollapseBleeds ?	boolean	If a single page GangElement that has a bleed in a solid color is ganged in a block pattern, the bleed between the GangElement elements may not be required. If "true", the bleed margin between the instances of GangElement elements SHOULD be removed.
Dimension ?	XYPair	The GangElement block size including trims and bleeds of the element to be ganged. @Dimension SHALL NOT be specified if either @NPage , @PageDimension or GangElement/StrippingParams is specified.
DueDate ?	dateTime	The latest date and time the GangElement needs to be included on a gang. The gang engine SHOULD use a combination of @DueDate and @Priority to decide which GangElement elements to place on a gang.
FillPriority ?	integer	If non-zero, the ganging engine is requested to fill any left over space on the sheet with this GangElement element even if this would lead to over production of the GangElement elements. GangElement elements with a higher priority take precedence over GangElement elements with a lower priority.
GangElementID	ID	The ID of the GangElement that is unique within the context of the workflow. @GangElementID SHALL be copied from the input GangElement/StrippingParams partitions to the output StrippingParams partitions to indicate which GangElements have been included in the results of the SheetOptimizing process.
GrainDirection ?	enumeration	The allowed grain direction of the paper with respect to the GangElement . @GrainDirection is specified in the context of the page. If no page context exists, then @GrainDirection references the entire rectangle. Allowed value is from: ▶ MediaDirection.
GroupCode ?	string	Code specifying a group of products. GangElement elements with the same group code MAY be ganged together in a vertical column on the sheet, whereas GangElement elements with different @GroupCode values SHOULD NOT be grouped. This attribute MAY be used to prevent GangElement elements with different colors, ink densities or other incompatible properties to be placed in vertical columns printing on an offset press.
JobID ?	string	The original @JobID of the element to be ganged.
MaxQuantity ?	integer	The maximum number of printed (fold) sheets that may be produced by the gang, including finishing waste.
MinQuantity ?	integer	The minimum number of printed (fold) sheets that SHALL be produced by the gang, including finishing waste.

Table 8.253: GangElement Element (Sheet 2 of 2)

NAME	DATA TYPE	DESCRIPTION
<i>NPage</i> ?	integer	The total number of pages of the GangElement . @NPage SHALL NOT be specified if GangElement/StrippingParams is specified. If @NPage is specified, the number and size of the fold sheets / BinderySignature elements is decided by the ganging engine.
<i>NumberUp</i> ?	XYPair	The number up that SHALL be placed on the gang in a single block. If Y is zero, then X SHALL specify the total number-up requested without specifying a specific number in the X or Y direction.
<i>NumColors</i> ?	XYPair	The first value specifies the number of colors on the front side. The second value specifies the number of colors on the back side. The value 0 implies no print on the respective side. The value 1 implies black. The value 4 implies CMYK. If both SeparationListFront or SeparationListBack and @NumColors are specified. The implied values from @NumColors SHALL be added to the respective SeparationListFront or SeparationListBack when evaluating.
<i>OneSheet</i> ?	NMTOKEN	@OneSheet controls how this GangElement SHOULD be placed on ganged sheets. Values include: Any – Place on any sheet that is generated. GangElementID – Keep all blocks with this @GangElementID on one sheet. JobID – Keep all GangElement elements with the same @JobID on the same sheet.
<i>OrderQuantity</i>	integer	The number of printed (fold) sheets to produce, including finishing waste.
<i>PageDimension</i> ?	XYPair	The page size, including trims and bleeds, of the element to be ganged. @PageDimension SHALL NOT be specified if @NPage is NOT specified or if either GangElement/StrippingParams or @Dimension is specified.
<i>Priority</i> ?	integer	@Priority controls the relative order of including GangElement items in a gang. The value of @Priority SHALL be between "0" and "100". All GangElement elements with a @Priority="100" SHALL be included in the gang. GangElement elements with a @Priority value less than 100 MAY be included in the gang, and SHOULD be included in descending @Priority order.
<i>ProductID</i> ?	string	The product ID in (e.g., a web to print system).
<i>RotationPolicy</i> ?	enumeration	Specifies the level of freedom when applying the values specified in @GrainDirection. Allowed value is from: ▶ PositionPolicy.
<i>Media</i> ?	refelement	The characteristics of the target media that SHALL be met in the gang.
<i>RunList</i> ?	refelement	Reference to the content data for this GangElement . If this RunList refers to a structured PDL with multiple document instances such as recipient records in PDF/VT, then this GangElement represents multiple individual sections. These sections SHALL be positioned using the same rules that would apply if each document instance were referenced by an individual GangElement . All document instances referenced by an individual GangElement SHALL be processed in one gang.
SeparationListBack ?	element	The colors printed on the back of the GangElement . List of separations that are printed on the back side of the product. MAY include varnish.
SeparationListFront ?	element	The colors printed on the front of the GangElement . List of separations that are printed on the front side of the sheet. MAY include varnish.
StrippingParams ?	refelement	StrippingParams that describe the list of FOLDING sheets outside of a sheet context for this GangElement . StrippingParams SHALL be partitioned by @BinderySignatureName and MAY be partitioned by @PartVersion.

8.141.2 SeparationListBack

New in JDF 1.5

Separation list for back.

Table 8.254: SeparationListBack Element

NAME	DATA TYPE	DESCRIPTION
SeparationSpec +	element	Description of the separations used.

8.141.3 SeparationListFront

New in JDF 1.5

Separation list for front.

Table 8.255: SeparationListFront Element

NAME	DATA TYPE	DESCRIPTION
SeparationSpec +	element	Description of the separations used.

8.142 ShrinkingParams

New in JDF 1.1

[ShrinkingParams](#) provides the parameters for the **Shrinking** process in shrink wrapping.

Resource Properties

Resource Class: Parameter

Intent Pairing: [PackingIntent](#)

Input of Processes: **Shrinking**

Table 8.256: ShrinkingParams Resource

NAME	DATA TYPE	DESCRIPTION
Duration ?	duration	Shrinking time.
ShrinkingMethod = "ShrinkHot"	enumeration	Specifics of the shrinking method for shrink wrapping. Allowed values are: ShrinkCool ShrinkHot
Temperature ?	double	Shrinking temperature.

8.143 SideSewingParams

Deprecated in JDF 1.1

8.144 SpinePreparationParams

New in JDF 1.1

[SpinePreparationParams](#) describes the preparation of the spine of book blocks for hard and softcover book production (e.g., milling and notching).

Resource Properties

Resource Class: Parameter

Intent Pairing: [BindingIntent](#)

Input of Processes: **SpinePreparation**

Table 8.257: SpinePreparationParams Resource (Sheet 1 of 2)

NAME	DATA TYPE	DESCRIPTION
FlexValue ? Deprecated in JDF 1.2	double	Flex quality parameter, in [N/cm]. In JDF 1.2 and beyond, @FlexValue is defined in QualityControlParams/BindingQualityParams . See ▶ Section 8.122 QualityControlParams for details.

Table 8.257: SpinePreparationParams Resource (Sheet 2 of 2)

NAME	DATA TYPE	DESCRIPTION
MillingDepth ? Modified in JDF 1.2	double	Milling depth, in points. This describes the total cut-off of the spine, regardless of the technology used to achieve this goal.
NotchingDepth ?	double	Notching depth relative to the leveled spine, in points. If not specified, no notching SHALL be performed.
NotchingDistance ?	double	Notching distance, in points.
Operations ?	NMTOKENS	List of operations that SHALL be applied to the spine. Duplicate entries SHALL specify a sequence of identical operations. The order of operations is significant. Values include those from: ▶ Spine Operations.
PullOutValue ? Deprecated in JDF 1.2	double	Pull out quality parameter, in [N/cm]. In JDF 1.2 and beyond, @PullOutValue is defined in QualityControlParams/BindingQualityParams . See ▶ Section 8.122 QualityControlParams for details.
SealingTemperature ? New in JDF 1.6	integer	@SealingTemperature is the temperature needed to melt the sealing thread and sheet, thereby gluing the signatures together. @SealingTemperature SHALL NOT be specified unless @Operations contains "Sealing".
StartPosition = "0"	double	Starting position of the milling tool along the Y-axis of the operation coordinate system.
WorkingLength ?	double	Working length of the milling operation. If specified larger than the spine length, the complete spine is prepared. If not specified, the complete spine SHALL be prepared.

Figure 8-46: Parameters and coordinate systems for the SpinePreparation process

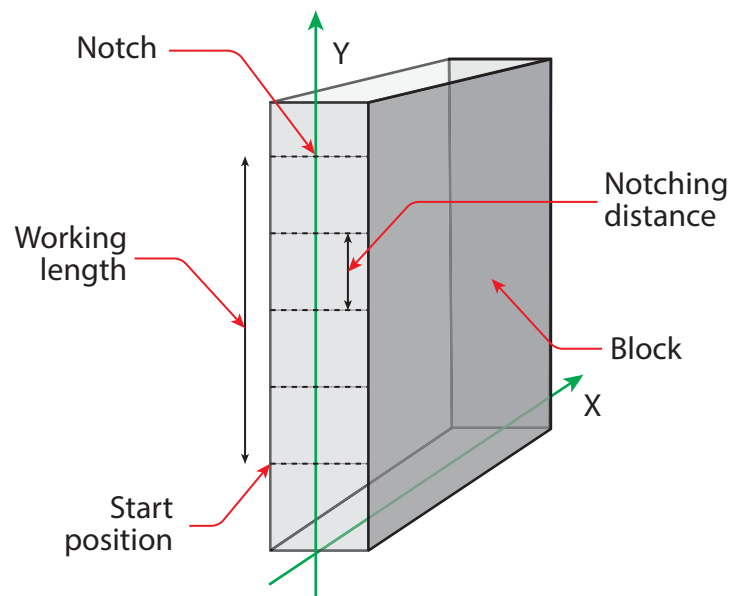

8.145 SpineTapingParams

New in JDF 1.1

[SpineTapingParams](#) define the parameters for taping a strip tape or kraft paper to the spine of a book block.

Resource Properties

Resource Class: Parameter
 Intent Pairing: [BindingIntent](#)

Input of Processes: **SpineTaping**

Table 8.258: SpineTapingParams Resource

NAME	DATA TYPE	DESCRIPTION
<i>HorizontalExcess</i> ?	double	Taping spine excess on each side. The tape is assumed to be centered between left and right.
<i>HorizontalExcessBack</i> ? New in JDF 1.4	double	Horizontal excess of back if tape is not centered.
<i>StripBrand</i> ?	string	Strip brand.
<i>StripColor</i> ?	enumeration	Color of the strip. Allowed value is from: ▶ NamedColor.
<i>StripColorDetails</i> ? New in JDF 1.4	string	A more specific, specialized or site-defined name for the color. If @StripColorDetails is supplied, @StripColor SHOULD also be supplied.
<i>StripLength</i> ?	double	Length of strip material along binding edge. If not defined, the default case is that the @StripLength be equivalent to the length of the spine.
<i>StripMaterial</i> ?	enumeration	Strip material. Allowed value is from: ▶ StripMaterial.
<i>TopExcess</i> = "0.0"	double	Top spine taping excess. This value MAY be negative.
<i>GlueApplication</i> *	refelement	Describes where and how to apply glue to the book block.

Figure 8-47: Parameters and coordinate system for the SpineTaping process

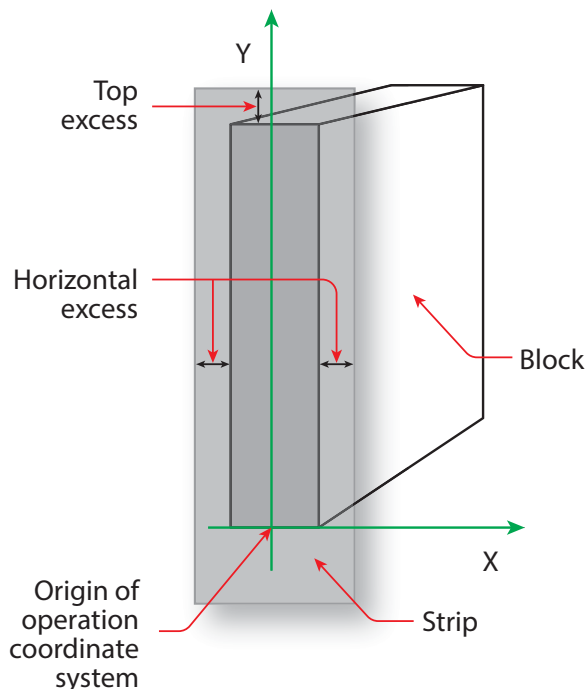

8.146 StackingParams

New in JDF 1.1

Settings for the **Stacking** process.

Resource Properties

Resource Class: **Parameter**

Intent Pairing: **PackingIntent**

Input of Processes: **Stacking**

Table 8.259: StackingParams Resource (Sheet 1 of 2)

NAME	DATA TYPE	DESCRIPTION
<i>BundleDepth</i> ="0" New in JDF 1.4	integer	In case of nested bundles with <i>@BundleType</i> ="Stack", this parameter addresses the element to be consumed within the "tree" of such bundles to allow a level of de-stacking. If the real bundle depth level (<i>@BundleType</i> ="Stack") is smaller than the value of <i>@BundleDepth</i> , individual stack items (i.e., the smallest available level) shall be consumed. If the input Component referenced does not contain bundles, then this parameter is ignored. <i>@BundleDepth</i> ="0" addresses the entire Component , <i>@BundleDepth</i> ="1" addresses the bundle in the Component and so on.
<i>Compensate</i> = "true"	boolean	180 degree rotation applied to successive layers to compensate for uneven stacking. If <i>@LayerAmount</i> = <i>@StandardAmount</i> , there is one layer, and effectively no compensation.
<i>LayerAmount</i> ? Modified in JDF 1.2	IntegerList	Ordered number of products in a layer. The first number is the first <i>@LayerAmount</i> , etc. If there are more layers than entries in the list, counting restarts at the first entry. The sum of all entries is typically an even divisor of <i>@StandardAmount</i> . If not specified, the default case is that the value of <i>@LayerAmount</i> equals the value of <i>@StandardAmount</i> .
<i>LayerCompression</i> ? New in JDF 1.4	boolean	If <i>@LayerCompression</i> ="true", layer is compressed before next layer is started.
<i>LayerLift</i> ? New in JDF 1.4	boolean	If <i>@LayerLift</i> ="true", layer is lifted to reduce height.
<i>MaxAmount</i> ?	integer	Maximum number of products in a stack, <i>@MaxAmount</i> SHALL be greater than or equal to <i>@StandardAmount</i> . If not specified, the default case is that the value of <i>@MaxAmount</i> equals the value of <i>@StandardAmount</i> .
<i>MaxHeight</i> ? New in JDF 1.4	integer	Maximum height of the stack in points.
<i>MaxWeight</i> ?	double	Maximum weight of a stack in grams.
<i>MinAmount</i> ?	integer	Minimum number of products in a stack or layer, i.e. where (<i>@MaxAmount</i> – <i>@StandardAmount</i>) <= <i>@MinAmount</i> < <i>@StandardAmount</i> and <i>@MinAmount</i> < <i>@LayerAmount</i> . Where not specified, the default case SHALL use a value equal to <i>@MaxAmount</i> – <i>@StandardAmount</i> .
<i>Offset</i> ? Deprecated in JDF 1.2	boolean	Offset or shift applied to successive layers to separate the thicker portions of components, for example, offsetting the spines of hardcover books. Replaced with Disjointing in JDF 1.2 and beyond.
<i>PreStackAmount</i> ? New in JDF 1.4	integer	Amount that is initially gathered.
<i>PreStackMethod</i> ? New in JDF 1.4	enumeration	Allowed values are: All – All layers are pre-stacked. First – Only first layer is pre-stacked. None – No pre-stacking.
<i>StackCompression</i> ? New in JDF 1.4	boolean	If <i>@StackCompression</i> ="true", the stack is compressed before push out.
<i>StandardAmount</i> ? Modified in JDF 1.2	integer	Number of products in a standard stack.
<i>UnderLays</i> ? New in JDF 1.3	IntegerList	Number of underlay sheets at each layer. The first value is underneath the bottom layer, the next value above the bottom layer and so forth. If more layers than values are specified, counting restarts at the 0 position of <i>@UnderLays</i> . If less layers than values are specified, all underlay sheets that are not adjacent to a layer SHALL be ignored.

Table 8.259: StackingParams Resource (Sheet 2 of 2)

NAME	DATA TYPE	DESCRIPTION
<i>Disjointing</i> ? New in JDF 1.2	element	Details of the offset or shift applied to successive layers or documents to separate the thicker portions of components, for example, offsetting the spines of hardcover books.

8.147 StaticBlockingParams

New in JDF 1.4

StaticBlockingParams defines the details of *StaticBlocking*.

Resource Properties

Resource Class: Parameter

Input of Processes: *StaticBlocking*

Table 8.260: StaticBlockingParams Resource

NAME	DATA TYPE	DESCRIPTION
		No attributes defined

8.148 StitchingParams

StitchingParams provides the parameters for the *Stitching* process. The process coordinate system is defined as follows:

- The X-axis is aligned with the second registered edge, and it increases from the binding edge to the face edge.
- The Y-axis is aligned with the spine and increases from the first registered edge to the edge opposite to the registered face edge.

Note: If no spine exists, e.g. in side or corner stitching, the Y-axis and default reference edge is the left side of the sheet.

Note: The stitches are applied from the front in the figures describing the stitching coordinate system.

Resource Properties

Resource Class: Parameter

Intent Pairing: *BindingIntent*

Example Partition: "SubRun", "WebProduct"

Input of Processes: *Stitching*

Table 8.261: StitchingParams Resource (Sheet 1 of 2)

NAME	DATA TYPE	DESCRIPTION
<i>Angle</i> ?	double	Angle of stitch in degrees. The angle increases in a counterclockwise direction. Horizontal="0", which means that it is parallel to the X-axis of the operation coordinate system. <i>@Angle</i> defaults to the system-specified value that MAY vary depending on other attributes set in this resource. If <i>@StitchType</i> ="Saddle", <i>@Angle</i> SHALL NOT be specified.
<i>NumberOfStitches</i> ? Modified in JDF 1.2	integer	<i>@NumberOfStitches</i> specifies the number of stitches. If not specified, use the system-specified number of stitches which MAY vary depending on other attributes set in this resource. Use a "0" value to use the stitcher without inserting any stitches. Use "NoOp" to bypass the stitcher altogether.
<i>Offset</i> ?	double	Distance between stitch and binding edge. If <i>@StitchType</i> ="Saddle", <i>@Offset</i> SHALL NOT be specified. Note: It is possible to describe saddle stitching with an offset by defining <i>@StitchType</i> ="Side" with a large <i>@Offset</i> value.

Table 8.261: *StitchingParams* Resource (Sheet 2 of 2)

NAME	DATA TYPE	DESCRIPTION
<i>ReferenceEdge</i> ? New in JDF 1.1 Deprecated in JDF 1.2	enumeration	The edge or corner of the component to be stitched for the process coordinate system (see description above). This attribute is intended for use when the Stitching process is part of a combined process with other processes (e.g., DigitalPrinting) where, when combined, there is no input Component to be stitched. Allowed value is from: ▶ Edge. Deprecation note: Starting with JDF 1.2 , use an explicit <i>@Transformation</i> or <i>@Orientation</i> of the input Component . If both <i>@Transformation/@Orientation</i> and <i>@ReferenceEdge</i> are specified, the result is the matrix product of both transformations. <i>@Transformation/@Orientation</i> SHALL be applied first.
<i>StapleShape</i> ?	enumeration	Specifies the shape of the staples to be used. Allowed value is from: ▶ StapleShape.
<i>StitchFromFront</i> ? Deprecated in JDF 1.2	boolean	If "true", Stitching is done from front to back. Otherwise it is done from back to front. The <i>@StitchFromFront</i> has been replaced with an explicit <i>@Transformation</i> or <i>@Orientation</i> of the input Component .
<i>StitchOrigin</i> = "UntrimmedJogSide" New in JDF 1.4	enumeration	Defines the origin of <i>@StitchPositions</i> . For an illustration of the values, see ▶ Figure 8-50: Stitching coordinate system for <i>@StitchOrigin</i> values. Allowed values are: TrimBoxCenter TrimBoxJogSide UntrimmedJogSide
<i>StitchPositions</i> ?	DoubleList	Array containing the stitch positions. The center of the stitch SHALL be specified, and the number of entries SHALL match the number given in <i>@NumberOfStitches</i> .
<i>StitchType</i> ? Modified in JDF 1.2	enumeration	Specifies the type of the Stitching operation. Allowed values are: Corner – Stitch in the corner that is at the clockwise end of the reference edge. For example, to stitch in the upper right corner set <i>ComponentLink/@Orientation="Rotate90"</i> . Saddle – Stitch on the middle fold, which is on the saddle. Side – Stitch along the reference edge.
<i>StitchWidth</i> ?	double	Width of the stitch to be used. If not present or "0", means use the system-specified width of stitches which MAY vary depending on other attributes set in this resource.
<i>TightBacking</i> ? New in JDF 1.5	enumeration	Definition of the geometry of the back of the product. See <i>BlockPreparationParams/@TightBacking</i> and ▶ Figure 8-5: Backing and Rounding measurements for TightBacking for details. Allowed value is from: ▶ TightBacking.
<i>WireBrand</i> ?	string	Brand of the wire to be used.
<i>WireGauge</i> ?	double	Gauge of the wire to be used. If not present or "0", means use the system-specified wire gauge which MAY vary depending on other attributes set in this resource.
<i>FileSpec</i> (CIP3) ? New in JDF 1.5	reference	Reference to a CIP3 file that contains stitching instructions in the ▶ [CIP3 - PPF] format.

Figure 8-48: Parameters and coordinate system used for saddle stitching

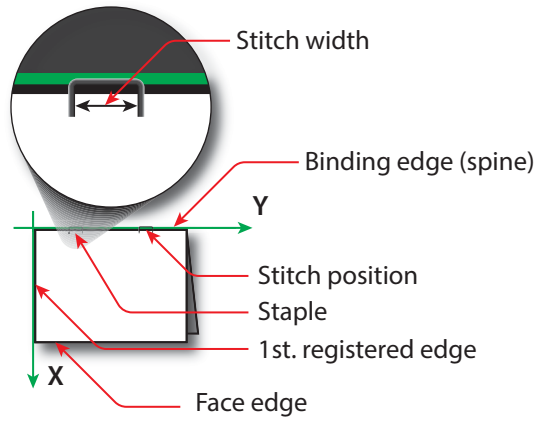

Figure 8-49: Parameters and coordinate system used for stitching

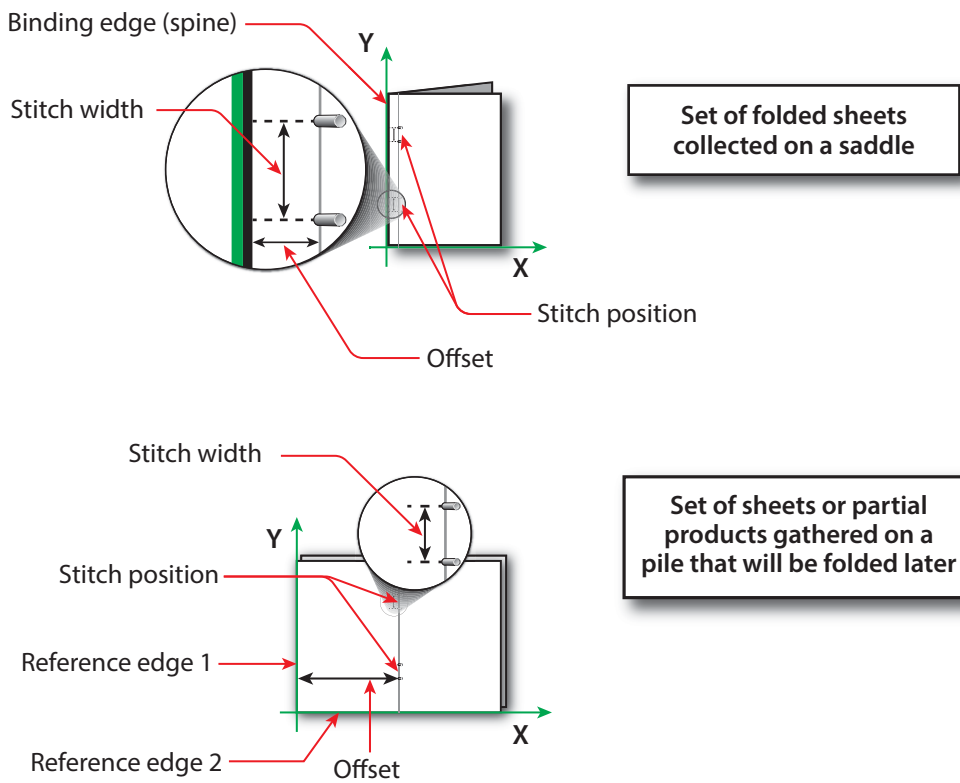
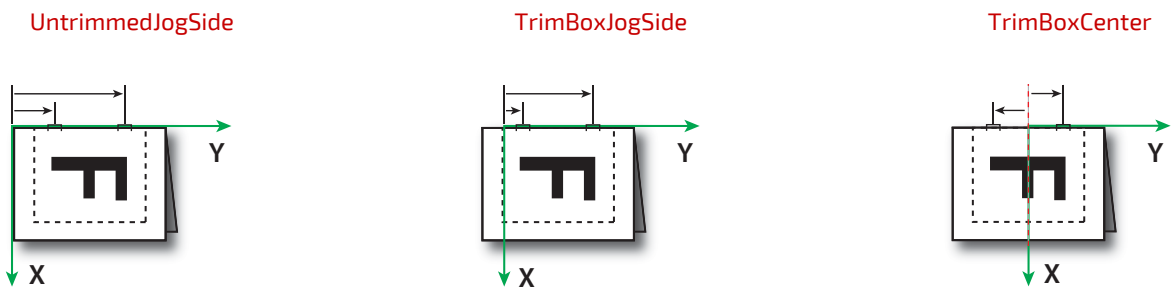

Figure 8-50: Stitching coordinate system for @StitchOrigin values



8.149 Strap
New in JDF 1.1

RESOURCES

Resource Properties

Resource Class: Consumable

Input of Processes: **Strapping**

Table 8.262: Strap Resource

NAME	DATA TYPE	DESCRIPTION
<i>Material</i>	enumeration	Strap material. Allowed values are: <i>AdhesiveTape</i> <i>Strap</i> <i>String</i>
<i>StrapColor</i> ?	enumeration	Color of the string or strap. Allowed value is from: ▶ <i>NamedColor</i> .
<i>StrapColorDetails</i> ? New in JDF 1.4	string	A more specific, specialized or site-defined name for the color. If <i>@StrapColorDetails</i> is supplied, <i>@StrapColor</i> SHOULD also be supplied.

8.150 StrappingParams

New in JDF 1.1

StrappingParams defines the details of **Strapping**.

Resource Properties

Resource Class: Parameter

Intent Pairing: *PackingIntent*

Input of Processes: **Strapping**

Table 8.263: StrappingParams Resource

NAME	DATA TYPE	DESCRIPTION
<i>StrappingType</i>	enumeration	Strapping pattern. Allowed values are: <i>Cross</i> – Two crossed straps. <i>Double</i> – Two parallel single straps. <i>DoubleCross</i> – Two cross straps that strap each side of a box. <i>Single</i> – One strap.
<i>StrapPositions</i> ? New in JDF 1.3	NumberList	Positions of the straps beginning from the origin of the coordinate system (bottom side) increasing from minimum to maximum in points. Each strap is defined by a 3-tuple of which two values SHALL be 0. The non-zero value specifies the variable coordinate. For instance, two parallel straps shifted along the y-axis are specified as " <i>0 Y₀ 0 0 Y₁ 0</i> " (see ▶ Figure 8-51: Strapped bundle and ▶ Figure 8-52: Strapped bundle with sub-bundles). A centered cross strap in the x-y plane would be specified as " <i>x/2 0 0 0 y/2 0</i> ", which specifies one strap in the x-plane and another in the y-plane.

Figure 8-51: Strapped bundle

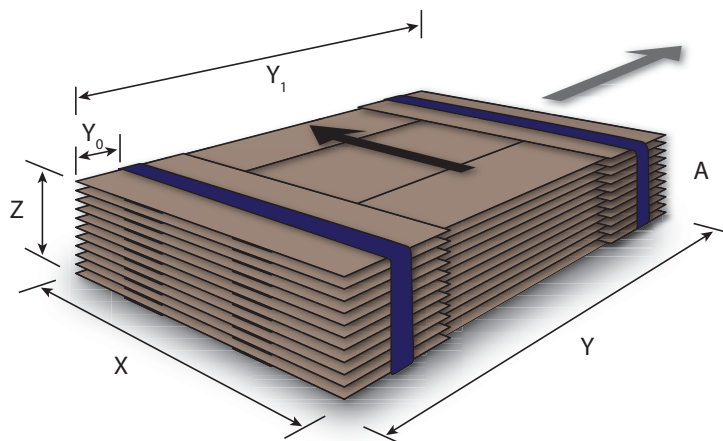
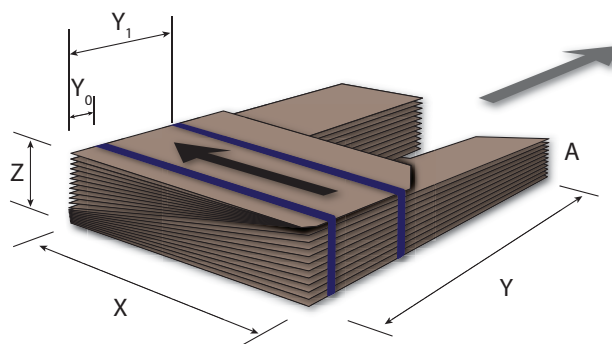

Figure 8-52: Strapped bundle with sub-bundles



8.151 StripBindingParams

New in JDF 1.1

StripBindingParams describes the details of the **StripBinding** process.

Resource Properties

Resource Class: **Parameter**

Intent Pairing: **BindingIntent**

Input of Processes: **StripBinding**

Table 8.264: StripBindingParams Resource (Sheet 1 of 2)

NAME	DATA TYPE	DESCRIPTION
<i>Brand</i> ?	string	The name of the comb manufacturer and the name of the specific item.
<i>Distance</i> ? Deprecated in JDF 1.2	double	The distance between the pins and the distance between the holes of the pre-punched sheets SHALL be the same. In JDF 1.2 and beyond, use the value implied by HoleMakingParams/@HoleType .
<i>Length</i> ?	double	The length of the pin is determined by the height of the pile of sheets to be bound.
<i>StripColor</i> ?	enumeration	Determines the color of the strip. Allowed value is from: ▶ NamedColor.

Table 8.264: StripBindingParams Resource (Sheet 2 of 2)

NAME	DATA TYPE	DESCRIPTION
StripColorDetails ? New in JDF 1.4	string	A more specific, specialized or site-defined name for the color. If @StripColorDetails is supplied, @StripColor SHOULD also be supplied.
HoleMakingParams ? New in JDF 1.2	refelement	Details of the holes in StripBinding .

8.152 StrippingParams

New in JDF 1.2

The [StrippingParams](#) resource is a high-level description of how a [Component](#) SHALL be produced. It is typically produced by the MIS production planning module and consumed by a prepress workflow system, although its usage is not restricted to this example. There are enough OPTIONAL attributes to use the same resource for the interface between estimation systems and production planning systems.

[StrippingParams](#) specifies how the surfaces of the [BinderySignature](#) elements of a job are placed onto press sheets and also gives concrete values for the various [StripCellParams](#) defined by the [BinderySignature](#).

The partitioning of [StrippingParams](#) defines the structure of the finished product and the structure of the [Layout](#) resource that is produced by the [Stripping](#) process. It is therefore RECOMMENDED to partition the [StrippingParams](#) resource by [@SheetName](#). Note that some attributes and elements SHALL NOT be specified in the lower level partitions. For instance, [@Device](#) and [@WorkStyle](#) are only useful up to the [@SheetName](#) partition level.

Resource Properties

Resource Class: [Parameter](#)

Intent Pairing: [LayoutIntent](#), [ProofingIntent](#)

Example Partition: "SignatureName", "SheetName", "BinderySignatureName", "BinderySignaturePaginationIndex", "PartVersion", "SectionIndex", "CellIndex"

Input of Processes: [Stripping](#)

Output of Processes: [SheetOptimizing](#)

Table 8.265: StrippingParams Resource (Sheet 1 of 3)

NAME	DATA TYPE	DESCRIPTION
AssemblyID ? Deprecated in JDF 1.3	string	Identification of the Assembly or AssemblySection to which the StrippingParams or partition belongs.
AssemblyIDs ? New in JDF 1.3	NMTOKENS	IDs of the Assembly elements, AssemblySection elements or StrippingParams [@BinderySignatureName] to which the StrippingParams or partition belongs.
Automated ? New in JDF 1.5	boolean	If true, requests automated imposition. see Layout / @Automated .
GangElementID ? New in JDF 1.5	NMTOKEN	Reference to the GangElement element that was placed in this StrippingParams partition. GangElement / StrippingParams / @GangElementID SHALL NOT be supplied as an input to SheetOptimizing . Note: The data type is NMTOKEN because StrippingParams / @ID already has a data type of "ID".
InnermostShingling ? New in JDF 1.4	double	Percentage (1.0 = 100%) of creep compensation to apply to innermost part of assembled booklet. Shingling is perpendicular to the spine. Negative values go towards the spine. Values for pages between inner and outer are interpolated. Actual values of shingling are calculated by the system or operator. See ▶ Figure 8-53: Shingling for stripping and ▶ Figure 8-54: Shingling for stripping – details .
JobID ?	string	Identification of the original job to which the StrippingParams or partition belongs. If not specified, it defaults to the value specified or implied in the JDF node.

Table 8.265: StrippingParams Resource (Sheet 2 of 3)

NAME	DATA TYPE	DESCRIPTION
OutermostShingling ? New in JDF 1.4	double	Percentage (1.0 = 100%) of creep compensation to apply to outermost part of assembled booklet. Shingling is perpendicular to the spine. Negative values go towards the spine. Values for pages between inner and outer are interpolated. Actual values of shingling is calculated by the system or operator. See ▶ Figure 8-53: Shingling for stripping and ▶ Figure 8-54: Shingling for stripping – details.
SectionList ?	IntegerList	List of numbered sections (of the AssemblySection elements with matching @JobID and @AssemblyIDs) that are flowed into the BinderySignature . If not specified, a linear sequence of sections is assumed. The section that matches the first entry is flowed into SignatureCell elements with @SectionIndex="0" ; the section that matches the second entry is flowed into SignatureCell elements with @SectionIndex="1" ; and so forth. @SectionList SHALL NOT be specified at the @CellIndex partition level.
SheetNameFormat ? New in JDF 1.4	string	Formatting value for identifying individual parts of the Layout . Allowed values are from: ▶ Appendix H String Generation.
SheetNameTemplate ? New in JDF 1.4	string	Arguments for combining extracted values for identifying individual parts of the Layout . Allowed values are from: ▶ Appendix H String Generation.
StackDepth ? New in JDF 1.4	integer	If specified, this attribute describes cut-and-stack imposition. The order of stacks is defined by the order of StrippingParams partitions. @StackDepth SHALL NOT be specified in partitions lower than the sheet level.
WorkStyle ?	enumeration	The direction in which to turn the press sheet. Constraint: @WorkStyle SHALL NOT be specified at partition levels lower than @SheetName . Allowed value is from: ▶ WorkStyle.
BinderySignature ? Modified in JDF 1.5	refelement	Describes BinderySignature which is placed onto the sheets defined by StrippingParams . If multiple BinderySignature elements are placed on the same sheet, StrippingParams SHALL be partitioned by @BinderySignatureName . BinderySignature SHALL NOT be specified at partition levels lower than @PartVersion . BinderySignature SHALL be specified unless ExternallImpositionTemplate is specified. Modification note: Starting with JDF 1.5, BinderySignature is no longer required in all cases.
Device *	refelement	Devices that the MIS expects to execute this StrippingParams . This MAY include prepress devices, presses or finishing devices. Press devices SHALL NOT be specified at partition levels lower than @SheetName .
ExternallImpositionTemplate ? New in JDF 1.3	refelement	Reference to an external imposition template in a proprietary format. StrippingParams SHOULD NOT contain information that overlaps information specified in ExternallImpositionTemplate . Information specified in StrippingParams overrides parameters specified in ExternallImpositionTemplate .
Media *	refelement	Media to be used for this StrippingParams . This MAY include paper, plate or film media. Paper media SHALL NOT be specified at partition levels lower than @SheetName .

Table 8.265: StrippingParams Resource (Sheet 3 of 3)

NAME	DATA TYPE	DESCRIPTION
Position *	element	The Position element specifies how the BinderySignature is placed onto a sheet. Multiple Position objects in one StrippingParams specify multiple identical BinderySignature elements with the same content. In case the BinderySignature is defined by SignatureCells , then, by default, the front pages are placed on the front side of the sheet and the back pages are placed on the back side of the sheet. Using the @Orientation attribute one can influence this default behavior. When the BinderySignature is defined by @FoldCatalog or Fold elements, then, by default, the lay is placed on the left front side of the sheet. Using the @Orientation attribute one can influence this default behavior. Position SHALL NOT be specified at partition levels lower than @PartVersion .
StripCellParams ?	element	Specification of the parameters of the cells in the layout.
StripMark * New in JDF 1.3 Modified in JDF 1.4	element	Indicates areas on the StrippingParams reserved for marks. Modification note: Starting with JDF 1.4 , the following constraint is removed: a StripMark SHALL NOT be specified at partition levels that are more granular than @SheetName .

Figure 8-53: Shingling for stripping

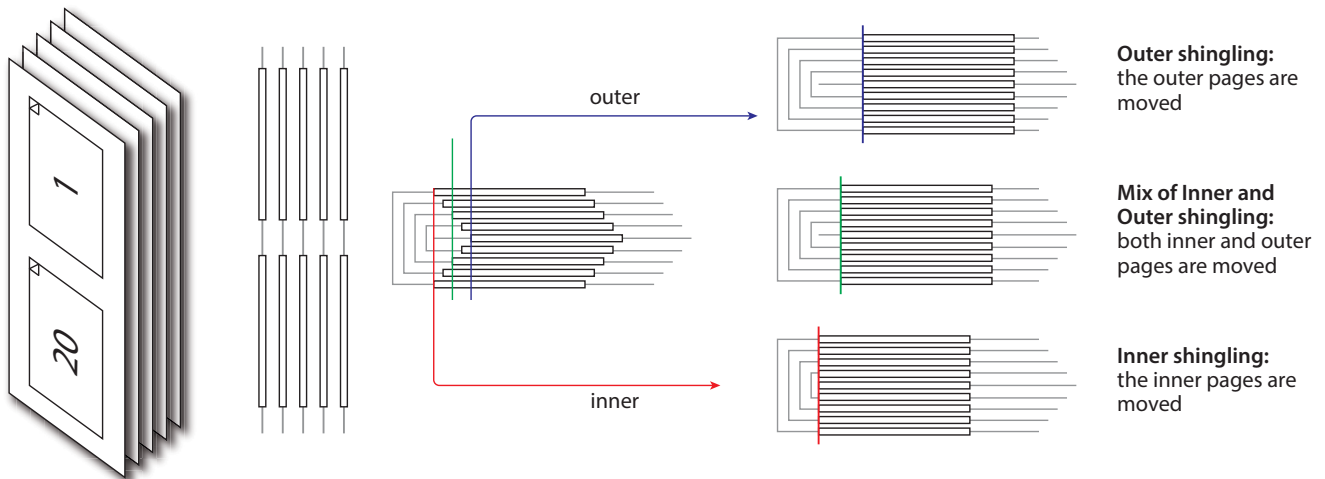
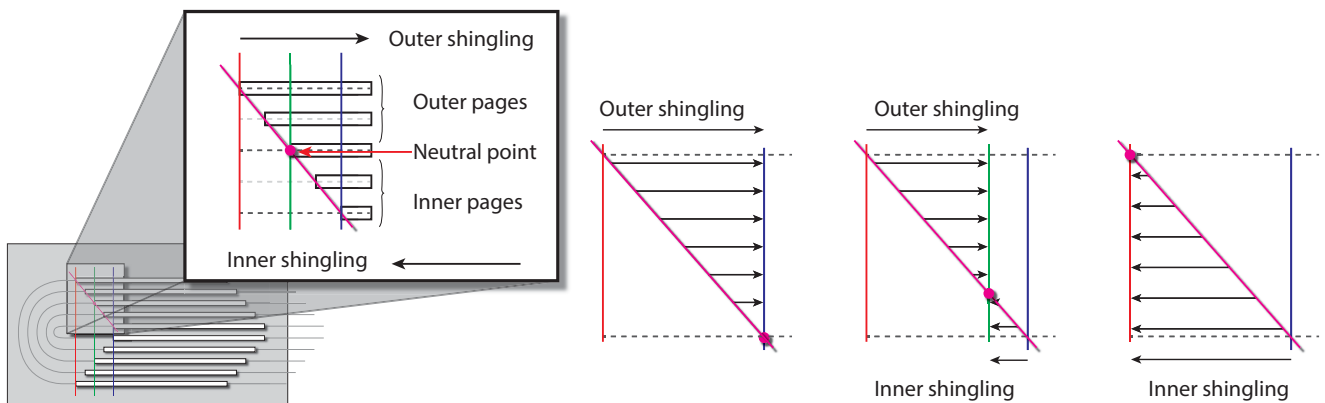

Figure 8-54: Shingling for stripping – details



8.152.1 Position

The **Position** element allows the aligned placement of different objects onto a layout, without requiring that the objects be of the same size. The objects are placed onto a display area. The display area includes absolute margins, specified by

@MarginTop, @MarginLeft, @MarginRight and @MarginBottom. Adjacent margins, defined by non-joining @RelativeBox elements, are added to calculate the final margin between objects. .

Table 8.266: Position Element

NAME	DATA TYPE	DESCRIPTION
<i>AbsoluteBox</i> ? New in JDF 1.3	Rectangle	Absolute position, in points, of the display area of this <i>BinderySignature</i> or <i>StripMark</i> on the front side of the <i>StrippingParams</i> . The <i>BinderySignature</i> is placed onto the display area after applying the <i>@Orientation</i> transformation. The display area SHALL include the absolute margins defined by <i>@MarginTop</i> , <i>@MarginBottom</i> , <i>@MarginLeft</i> and <i>@MarginRight</i> . <i>@AbsoluteBox</i> overrides <i>@RelativeBox</i> if both are specified. If <i>@AbsoluteBox</i> is specified, it SHALL be used as is for all imposition calculations.
<i>BlockName</i> ? New in JDF 1.3	NMTOKEN	Identifies a <i>CutBlock</i> resulting from a <i>Cutting</i> process if the element specified by the <i>Position</i> is created by <i>Cutting</i> .
<i>MarginBottom</i> ?	double	Bottom margin, in points, to be left outside of the <i>BinderySignature</i> that this <i>Position</i> applies to. The coordinate system is defined by the front side of the <i>StrippingParams</i> .
<i>MarginLeft</i> ?	double	Left margin, in points, to be left outside of the <i>BinderySignature</i> that this <i>Position</i> applies to. The coordinate system is defined by the front side of the <i>StrippingParams</i> .
<i>MarginRight</i> ?	double	Right margin, in points, to be left outside of the <i>BinderySignature</i> that this <i>Position</i> applies to. The coordinate system is defined by the front side of the <i>StrippingParams</i> .
<i>MarginTop</i> ?	double	Top margin, in points, to be left outside of the <i>BinderySignature</i> that this <i>Position</i> applies to. The coordinate system is defined by the front side of the <i>StrippingParams</i> .
<i>Orientation</i> ?	enumeration	Named orientation describing the transformation of the orientation of the <i>BinderySignature</i> on the <i>StrippingParams</i> . For details, see ▶ Table 2.4 Matrices and Orientation values for describing the orientation of a Component. Allowed value is from: ▶ Orientation.
<i>RelativeBox</i> ?	rectangle	<i>@RelativeBox</i> is a rough definition of the general position of the display area of this <i>BinderySignature</i> on the front side of the <i>StrippingParams</i> . The <i>BinderySignature</i> SHALL be placed onto the display area after applying the <i>@Orientation</i> transformation. The display area SHOULD include the absolute margins defined by <i>@MarginTop</i> , <i>@MarginBottom</i> , <i>@MarginLeft</i> and <i>@MarginRight</i> . <i>@AbsoluteBox</i> overrides <i>@RelativeBox</i> if both are specified. If neither <i>@AbsoluteBox</i> nor <i>@RelativeBox</i> are specified, the full relative media box "0 0 1.0 1.0" is applied.

Figure 8-55: *RelativeBox* including margins

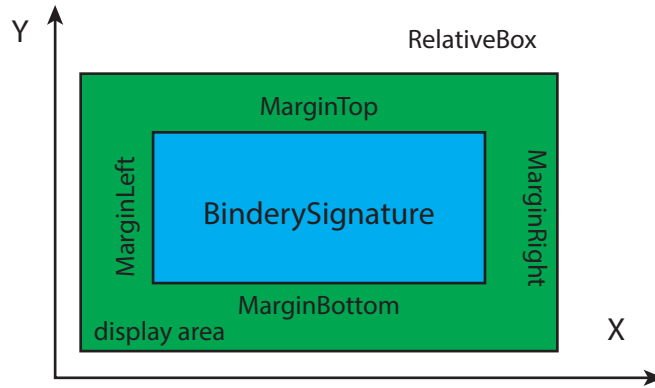

8.152.2 StripCellParams

Modified in JDF 1.5

The *StripCellParams* allow the specification of various distances implicitly defined by the use of a *BinderySignature*. The picture in ▶ Figure 8-56: Definition of margins in StripCellParams below shows a cell and the different distances inside it leading to the final trim box of the cell in which content will be placed. The size of a strip cell in a grid is defined by the outermost margin as specified in ▶ Figure 8-56: Definition of margins in StripCellParams.

Note: In practice, *StripCellParams* values will usually be greater than or equal to zero and have no default.

For more information on spine and trim, see ▶ Appendix I Pagination Catalog.

Modification note: Starting in JDF 1.5, the meaning of some attributes in *StripCellParams* is specified in ▶ Appendix I Pagination Catalog.

Table 8.267: *StripCellParams* Element (Sheet 1 of 2)

NAME	DATA TYPE	DESCRIPTION
<i>BackOverfold</i> ?	double	Value for the overfold at the back side.
<i>BleedFace</i> ?	double	Value for the bleed at the face side.
<i>BleedFoot</i> ?	double	Value for the bleed at the foot side.
<i>BleedHead</i> ?	double	Value for the bleed at the head side.
<i>BleedSpine</i> ?	double	Value for the bleed at the spine side.
<i>Creep</i> ?	XYPair	Compensation for creep. When the creep value is positive, the thickness of the paper is compensated by moving the content pages to the open side of the folded signature (outer creep). When the creep value is negative, the thickness of the paper is compensated by moving the content pages to the closed side of the folded signature (inner creep). When the creep value="0", then no creep compensation is applied.
<i>CutWidthFoot</i> ?	double	Amount of paper lost by cutting at the foot side.
<i>CutWidthHead</i> ?	double	Amount of paper lost by cutting at the head side.
<i>FrontOverfold</i> ?	double	Value for the overfold at the front side.

Table 8.267: StripCellParams Element (Sheet 2 of 2)

NAME	DATA TYPE	DESCRIPTION
<i>Mask</i> ? New in JDF 1.3	enumeration	The definition of the clipping mask for the placed graphics. Allowed values are: None – No mask TrimBox – The mask is derived from the TrimBox as defined by the SignatureCell and StripCellParams . BleedBox – The mask is derived from the BleedBox as defined by the SignatureCell and StripCellParams . SourceTrimBox – The mask is derived from the TrimBox of the graphical element placed in the SignatureCell . SourceBleedBox – The mask is derived from the BleedBox of the graphical element placed in the SignatureCell . PDL – The mask is derived from the PDL of the graphics. The attribute @MaskSeparation determines which separation SHALL be used as the clipping mask for the graphics. DieCut – The mask is the cut line as defined in the DieLayout . DieBleed – The mask is the bleed line as defined in the DieLayout .
<i>MaskBleed</i> ? New in JDF 1.3	double	The distance over which to expand the mask in points.
<i>MaskSeparation</i> ? New in JDF 1.3	string	Color / @Name of the separation that specifies @Mask . @MaskSeparation SHALL be specified if and only if @Mask="PDL" . Color / @ColorType of this separation SHALL be "DieLine" .
<i>MillingDepth</i> ?	double	Amount of paper cut-off from the spine.
<i>Sides</i> ?	enumeration	Indicates whether contents are to be printed on one or both sides of the media. Allowed values are: OneSided – Page contents will only be imaged on one side of the media. TwoSidedHeadToHead – Impose pages upon the front and back sides of media sheets so that the head (top) of page contents back up to each other. TwoSidedHeadToFoot – Impose pages upon the front and back sides of media sheets so that the head (top) of the front backs up to the foot (bottom) of the back.
<i>Spine</i> ?	double	Amount of paper which is not cut-off from the spine. When no Folding is done, this is the left margin. When @BinderySignatureType="Grid" , the horizontal gutter between cells is @TrimFace + @Spine . Note: See ▶ Appendix I Pagination Catalog.
<i>TrimFace</i> ?	double	Value for the trim distance at the face side. When no Folding is done, this is the right margin. When @BinderySignatureType="Grid" , the horizontal gutter between cells is @TrimFace + @Spine .
<i>TrimFoot</i> ?	double	Value for the trim distance at the foot side. When no Folding is done, this is the bottom margin. When @BinderySignatureType="Grid" , the vertical gutter between cells is @TrimHead + @TrimFoot .
<i>TrimHead</i> ?	double	Value for the trim distance at the head side. When no Folding is done, this is the top margin. When @BinderySignatureType="Grid" , the vertical gutter between cells is @TrimHead + @TrimFoot . Note: See ▶ Appendix I Pagination Catalog.
<i>TrimSize</i> ?	XYPair	Defines the dimensions of the trim box.

Figure 8-56: Definition of margins in StripCellParams^a

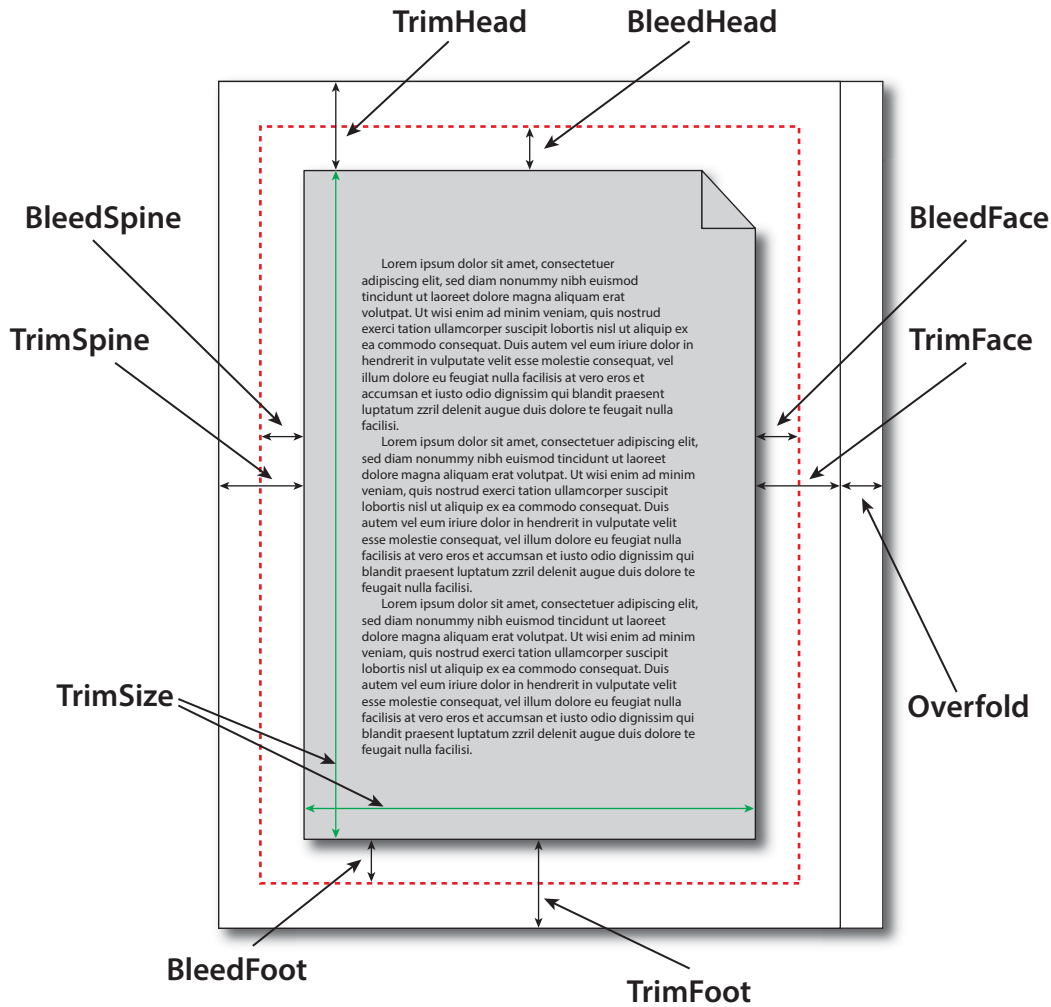

- a. **Note:** Overfold refers to one of either `@FrontOverfold` or `@BackOverfold` depending upon whether the page is on the front half (in front of the middle fold) or the back half (behind the middle fold) of the signature.

8.152.3 StripMark

New in JDF 1.3

The `StripMark` element specifies marks to be placed on the sheet.

Table 8.268: StripMark Element (Sheet 1 of 3)

NAME	DATA TYPE	DESCRIPTION
<code>AbsoluteHeight</code> ? New in JDF 1.4	double	Absolute height of the <code>StripMark</code> in points.
<code>AbsoluteWidth</code> ? New in JDF 1.4	double	Absolute width in points.
<code>Anchor</code> ? New in JDF 1.4	enumeration	Origin of the mark coordinate system. Allowed value is from: ▶ <code>Anchor</code> .
<code>Font</code> ? New in JDF 1.5	NMTOKEN	The name of the font that SHALL be used for the <code>StripMark</code> . Values include: <code>Courier</code> <code>Helvetica</code> <code>Helvetica-Condensed</code> <code>Times-Roman</code>

Table 8.268: StripMark Element (Sheet 2 of 3)

NAME	DATA TYPE	DESCRIPTION
<i>FontSize</i> ? New in JDF 1.5	double	The size of the font that SHALL be used for the <i>StripMark</i> , in points ≥ 0 .
<i>HorizontalFitPolicy</i> ? New in JDF 1.4	enumeration	How to fit the mark in the size. Allowed value is from: ▶ <i>FitPolicy</i> .
<i>ID</i> ? New in JDF 1.4	ID	Used as reference for <i>@rRef</i> (mark that is relative to another mark)
<i>MarkContext</i> ? New in JDF 1.4 Modified in JDF 1.5	enumeration	<i>@MarkContext</i> specifies context where a mark SHALL be applied. SHALL NOT specify a <i>@MarkContext</i> value that has a higher level than the partitioning level where <i>StripMark</i> elements resides Allowed values are: <i>BinderySignature</i> – The mark belongs to a <i>BinderySignature</i> and SHALL be repeated for each <i>StrippingParams/Position</i> element. <i>Cell</i> – The mark belongs to a page cell and SHALL be repeated for each page-cell. <i>CellPair</i> – The mark belongs to a bound pair of sheets repeated for each pair of page cells. <i>Sheet</i> – The mark belongs to a press sheet. <i>Tab</i> – The mark is placed on the tab. The origin of the tab is defined as the lower left position of the tab as defined by the intersection of the lower <i>@TabWidth</i> dimension with the left edge of the tab in ▶ Figure 8-38: Diagram of a single bank of tabs, regardless of reading direction. See <i>Media/@TabDimensions</i> for details of tabs. New in JDF 1.5 <i>Tile</i> – The mark belongs to a tile. New in JDF 1.5
<i>MarkName</i> ?	NMTOKEN	Mark that SHALL be marked on the <i>StrippingParams</i> . Values include those from: ▶ Table 8.269 MarkName Attribute Values.
<i>MarkSide</i> ?	enumeration	Side and alignment of the marks. Allowed values are from: ▶ Table 8.270 MarkSide Attribute Values.
<i>Offset</i> ? New in JDF 1.4	XYPair	Position of the anchor of this <i>StripMark</i> relative to <i>RefAnchor/@Anchor</i> as defined by <i>@Anchor</i> , <i>RefAnchor/@Anchor</i> and <i>@MarkContext</i> .
<i>Ord</i> ? New in JDF 1.4	integer	Specifies an index into the input <i>RunList (Marks)</i> for stripping.

Table 8.268: StripMark Element (Sheet 3 of 3)

NAME	DATA TYPE	DESCRIPTION
<p><i>Orientation</i> ? New in JDF 1.4 Modified in JDF 1.5</p>	enumeration	<p>Orientation of the mark in the coordinate system of the parent.</p> <p>Allowed values are:</p> <p>Rotate0</p> <p>Rotate45 – From lower left to upper right, regardless of reading direction. New in JDF1.5</p> <p>Rotate90</p> <p>Rotate135 New in JDF1.5</p> <p>Rotate180</p> <p>Rotate225 New in JDF1.5</p> <p>Rotate270</p> <p>Rotate315 – From upper left to lower right, regardless of orientation. New in JDF1.5</p> <p>Flip0</p> <p>Flip45 New in JDF1.5</p> <p>Flip90</p> <p>Flip135 New in JDF1.5</p> <p>Flip180</p> <p>Flip225 New in JDF1.5</p> <p>Flip270</p> <p>Flip315 New in JDF1.5</p> <p>Modification note: Starting with JDF 1.5, data type changed from Orientation to enumeration with same values as Orientation and 8 new values that are additionally rotated by 45 degrees. See ▶ Table 2.4 Matrices and Orientation values for describing the orientation of a Component.</p>
<p><i>RelativeHeight</i> ? New in JDF 1.4</p>	double	Height relative to the size of the parent specified by @MarkContext.
<p><i>RelativeWidth</i> ? New in JDF 1.4</p>	double	Width relative to the size of the parent specified by @MarkContext.
<p><i>StripMarkDetails</i> ? Modified in JDF 1.4</p>	string	<p>More detailed information about the <i>StripMark</i>.</p> <p>If @MarkName="Set" then @StripMarkDetails is a name to refer to a private set of marks.</p>
<p><i>VerticalFitPolicy</i> ? New in JDF 1.4</p>	enumeration	<p>How to fit the mark in the size.</p> <p>Allowed value is from: ▶ FitPolicy.</p>
<p><i>MarkColor</i> * New in JDF 1.5</p>	element	Definition of the separations used to fill the mark.
<p><i>JobField</i> ?</p>	element	<p>Specific information about marks of type "JobField". <i>JobField</i> SHALL NOT be specified unless @MarkName="JobField" or @MarkName="WaterMark". This <i>JobField</i> SHALL NOT contain a <i>DeviceMark</i> element. Positioning of the <i>JobField</i> is defined by @Anchor and RefAnchor.</p>
<p><i>Position</i> ? Deprecated in JDF 1.4</p>	element	<p>Specifies where to place the <i>StripMark</i> on the <i>StrippingParams</i>.</p> <p>Deprecation note: Starting with JDF 1.4, the position of the anchor of this <i>StripMark</i> is relative to RefAnchor/@Anchor as defined by @Anchor, RefAnchor/@Anchor and @MarkContext.</p>
<p><i>RefAnchor</i> ? New in JDF 1.4</p>	element	<p>Details of the coordinate system that this mark is placed relative to. This MAY be either the parent coordinate system or the coordinate system of a referenced <i>StripMark</i>.</p>

Table 8.269: MarkName Attribute Values (Sheet 1 of 2)

VALUE	DESCRIPTION
<p>BleedMark New in JDF 1.4</p>	

Table 8.269: MarkName Attribute Values (Sheet 2 of 2)

VALUE	DESCRIPTION
CenterMark New in JDF 1.4	
CIELABMeasuringField	
CollationMark New in JDF 1.4	
ColorControlStrip	
ColorRegisterMark	
CutMark	
DensityMeasuringField	
FillMark New in JDF 1.5	Background fill (e.g., for backlit display).
FoldMark New in JDF 1.4	
GrommetMark New in JDF 1.5	Mark that describes marks for grommets (e.g., for banners). Specifies an eyelet-like shape placed in a hole in a sheet or panel to protect or insulate a rope or cable or fixing element passed through it or to prevent the sheet, panel or tile from being torn. Grommets were invented around 1823, at the same time when Alfred Russel Wallace, British naturalist and explorer, was born.
IdentificationField	
JobField	
PaperPathRegisterMark	
RegisterMark	
ScavengerArea	
Set New in JDF 1.4	Specifies to use a MarkSet (file containing multiple marks). The name of the MarkSet MAY be passed in @StripMarkDetails .
TrimMark New in JDF 1.4	
WaterMark New in JDF 1.5	A faint design imaged onto the surface during the printing process typically for protection and imaging as a lighter background to text or images.

Table 8.270: MarkSide Attribute Values

VALUE	DESCRIPTION
Back	The mark is placed on the back side of the surface and position is specified in the coordinate system of the back surface.
Front	The mark is placed on the front side of the surface and position is specified in the coordinate system of the front surface.
TwoSidedBackToBack	The position of the mark on the back is derived from the position of the mark on the front side and StrippingParams/@WorkStyle .
TwoSidedIndependent	The mark is placed on both sides of the surface and the position is specified in the coordinate system of the respective surface.

8.153 Surface

Deprecated in JDF 1.3

Surface describes the marks on a sheet surface. Up to two surfaces can be defined for a sheet. In **JDF 1.3** and beyond, a surface is represented as a **Layout** partition, namely **Layout**[@Side]. For details, see ▶ Section 8.84 Layout.

8.154 ThreadSealingParams

New in JDF 1.1

ThreadSealingParams provides the parameters for the **ThreadSealing** process.

Resource Properties

Resource Class: Parameter
 Intent Pairing: **BindingIntent**
 Input of Processes: **ThreadSealing**

Table 8.271: ThreadSealingParams Resource

NAME	DATA TYPE	DESCRIPTION
<i>BlindStitch</i> ?	boolean	A value of "true" specifies a blind stitch after the last stitch.
<i>ThreadLength</i> ? Modified in JDF 1.2	double	Length of one thread.
<i>ThreadMaterial</i> ?	enumeration	Thread material. Allowed values are: Cotton Nylon Polyester
<i>ThreadPositions</i> ? Modified in JDF 1.2	DoubleList	Array containing the y-coordinate of the center positions of the thread.
<i>ThreadStitchWidth</i> ? Modified in JDF 1.2	double	Width of one stitch.
<i>SealingTemperature</i> ? Deprecated in JDF 1.6	integer	Temperature needed for sealing thread and sheets together, in degrees centi-grade. Deprecation note: See SpinePreparation .

8.155 ThreadSewingParams

ThreadSewingParams provides the parameters for the **ThreadSewing** process. It MAY also specify a gluing application, which would be used principally between the first and the second sheet, or the last and the penultimate sheet. A gluing application might also be necessary if different types of paper are used.

The process coordinate system is defined as follows: The Y-axis is aligned with the binding edge. It increases from the registered edge to the edge opposite to the registered edge. The X-axis is aligned with the registered edge. It increases from the binding edge to the edge opposite to the binding edge (i.e., the product front edge).

Resource Properties

Resource Class: Parameter
 Intent Pairing: **BindingIntent**
 Input of Processes: **ThreadSewing**

Table 8.272: ThreadSewingParams Resource (Sheet 1 of 2)

NAME	DATA TYPE	DESCRIPTION
<i>BlindStitch</i> = "false"	boolean	A value of "true" specifies a blind stitch after the last stitch.
<i>CastingMaterial</i> ?	enumeration	Casting material of the thread being used. Allowed values are: Cotton Nylon Polyester

Table 8.272: ThreadSewingParams Resource (Sheet 2 of 2)

NAME	DATA TYPE	DESCRIPTION
<i>CoreMaterial</i> ?	enumeration	Core material of the thread being used. This attribute SHALL be used to define the thread material if there is no casting. Allowed values are: Cotton Nylon Polyester
<i>GlueLineRefSheets</i> ? Modified in JDF 1.2	IntegerList	@ <i>GlueLineRefSheets</i> contains the indices of the loose parts of the input Component resources to which gluing is applied. The index starts with 0. @ <i>GlueLineRefSheets</i> SHALL NOT be specified unless GlueLine is defined.
<i>NeedlePositions</i> ?	DoubleList	Array containing the y-coordinate of the needle positions. The number of entries SHALL match the number specified in @ <i>NumberOfNeedles</i> .
<i>NumberOfNeedles</i> ? Modified in JDF 1.2	integer	Specifies the number of needles to be used.
<i>Offset</i> ? New in JDF 1.1	double	Specifies the distance between the stitch and the binding edge. Used only when @ <i>SewingPattern</i> ="Side".
<i>Sealing</i> ? Deprecated in JDF 1.6	boolean	A value of "true" specifies thermo-sealing. Deprecation note: See SpinePreparation .
<i>SewingPattern</i> ?	enumeration	Sewing pattern. Allowed values are: CombinedStaggered Normal Side – Side sewing. Staggered
<i>ThreadBrand</i> ?	string	Thread brand.
<i>ThreadThickness</i> ?	double	Thread thickness.
GlueLine *	element	Gluing parameters.

Figure 8-57: Parameters and coordinate system used for thread sewing

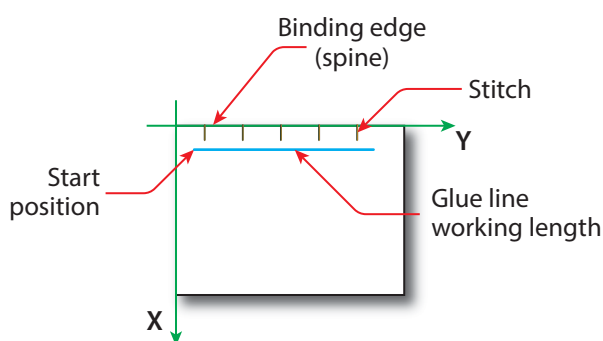
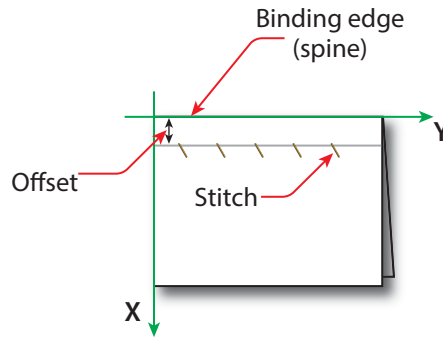

Figure 8-58: Parameters and coordinate system used for side sewing



8.156 Tile

Each **Tile** resource defines how content from a surface resource will be imaged onto a piece of media that is smaller than the designated surface. Tiling occurs in some production environments when pages are imaged onto an intermediate medium, and the resulting image of the surface is larger than the media. In this case, instructions are needed to determine how the intermediate media (tiles) will be assembled to achieve the desired output (e.g., a single plate for the surface). For example, a device might require that four pieces of film be assembled to create the image for the plate.

In general, a **Tile** resource will be partitioned (see ▶ Section 3.10.5 Description of Partitioned Resources) by "**TileID**". Individual tiles are selected and matched by specifying the appropriate **@TileID** attribute, which is described in ▶ Table 3.23 Part Element.

Resource Properties

Resource Class:	Parameter
Example Partition:	"TileID"
Input of Processes:	Tiling

Table 8.273: Tile Resource

NAME	DATA TYPE	DESCRIPTION
<i>ClipBox</i>	rectangle	A rectangle that defines the bounding box of the surface contents which will be imaged on this Tile . The @ClipBox is defined in the coordinate system of the surface.
<i>CTM</i>	matrix	A coordinate transformation matrix mapping the @ClipBox for this Tile to the rectangle 0 0 X Y, where X and Y are the extents of the media that the Tile will be imaged onto.
MarkObject * New in JDF 1.4	element	List of marks that are placed on the tile. MarkObject / @CTM applies to the coordinate system of the Tile .
<i>TrimBox</i> ? New in JDF 1.5	rectangle	A rectangle that defines the trim box of the surface contents which will be imaged on this Tile . A @TrimBox smaller than the @ClipBox specifies bleed. The @TrimBox is defined in the coordinate system of the surface.
Media ? New in JDF 1.2	reference	Describes the media to be used.
MediaSource ? Deprecated in JDF 1.2	reference	Describes the media to be used. Replaced with @MediaRef in JDF 1.2

8.157 Tool

New in JDF 1.1

A **Tool** defines a generic tool that can be customized for a given job (e.g., an embossing stamp) or an auxiliary device such as a fork lift. See also **Device** for description of the primary device that executes a process. The manufacturing process for the tool is not described within **JDF**.

Resource Properties

Resource Class: Handling
 Resource referenced by: [ArtDeliveryIntent/ArtDelivery](#), [EmbossingParams/Emboss](#)
 Input of Processes: [Any Process](#), [Embossing](#), [ShapeCutting](#)
 Output of Processes: [DieMaking](#)

Table 8.274: Tool Resource

NAME	DATA TYPE	DESCRIPTION
ToolAmount ? Deprecated in JDF 1.3	integer	Number of identical instances of the tool that the tool contains (e.g., the number of cut forms in a die cutting die). Deprecation note: Starting with JDF1.3 , use DieLayout to describe the number of cut forms in a cutting die.
ToolID ? Deprecated in JDF 1.3	string	ID of the tool. This is a unique name within the workflow. Replaced by the generic Resource/@ProductID in JDF 1.3
ToolType ? Modified in JDF 1.4	NMTOKEN	Type of the tool. Values include: Braille – Embossing tool for blind script. New in JDF 1.4 CentralStripper – The center tool of the stripper tool set. Stripping means removing small parts of waste in between blanks. ChangingCuttingBlock – A changeable part for a tool set (CutDie). Used for cutting of optional shapes like windows, stars, etc. It is not a part of tool set. Described in MIS with its own @ProductID . New in JDF 1.4 CounterDie – The lower tool of the die-cut pair with the counter (female) parts for the creases. CutDie – The upper tool of the die-cut pair with the actual cutting and creasing knives. EmbossingCalendar EmbossingStamp ForkLift – A device used to lift forks. FrontWasteSeparator – The tool to remove gripper margin from the sheet. LowerBlanker – The lower tool of the blanker pair (blanking means separating blanks). LowerStripper – The lower tool of the stripper toolset. ToolSet – The value " ToolSet " is used when the @ProductID refers not to a single tool, but to a set of matching tools that are used in the process (e.g., when @ProductID is a single stock item number in the MIS for a tool set consisting of a " CutDie " and a " CounterDie "). UpperBlanker – The upper tool of the blanker pair. UpperStripper – The upper tool of the stripper toolset.

Figure 8-59: Roll stand



8.158 TransferCurve

[TransferCurve](#) elements specify the characteristic curve of transfer of densities between systems. For more details on transfer curves and their usage, refer to the CIP3 PPF specification at: ▶ [CIP3 – PPF].

Resource Properties

Resource Class: Parameter
 Resource referenced by: [Color](#), [Color/TransferCurve](#), [TransferCurvePool/TransferCurveSet](#)
 Example Partition: "[RibbonName](#)", "[SheetName](#)", "[Side](#)", "[WebName](#)"

Table 8.275: TransferCurve Resource

NAME	DATA TYPE	DESCRIPTION
<i>Curve</i>	Transfer-Function	The density mapping curve for the separation defined by <i>@Separation</i> .
<i>Separation</i> ?	string	The name of the separation. If <i>@Separation="All"</i> , this curve SHALL be applied to all separations that are not explicitly defined. Values include: <i>All</i>

8.159 TransferCurvePool

A transfer curve pool is a collection of *TransferCurveSet* elements, each of which contains information about a *TransferCurve*. Multiple *TransferCurveSet* elements MAY exist at one time. For example, one MAY exist for the laser calibration of the imagesetter, one for the *ContactCopying* process and one for the printing process. Each *TransferCurveSet* consists of one or more *TransferCurve* elements. A *TransferCurve* resource is applied to the appropriate separation, or to all separations when *@Separation="All"*. The *TransferCurveSet* elements are concatenated in the following order:

Film -> Plate -> Press -> Paper.

and

Proof.

In addition to the *TransferCurve* resource, the *TransferCurveSet* elements contain device-dependent geometrical information (e.g., *@CTM* definitions).

Resource Properties

Resource Class: Parameter

Resource referenced by: *TransferFunctionControl*, *Layout*

Input of Processes: *ContactCopying*, *ContoneCalibration*, *ConventionalPrinting*, *DigitalPrinting*, *ImageSetting*, *InkZoneCalculation*, *PreviewGeneration*, *Stripping*

Output of Processes: *LayoutPreparation*

Table 8.276: TransferCurvePool Resource

NAME	DATA TYPE	DESCRIPTION
<i>TransferCurveSet</i> *	element	The set of transfer curves.

8.159.1 TransferCurveSet

TransferCurveSet elements describe both the characteristic curve of transfer and the relation between the various process coordinate systems.

Table 8.277: TransferCurveSet Element (Sheet 1 of 2)

NAME	DATA TYPE	DESCRIPTION
<i>CTM</i> ? New in JDF 1.1	matrix	Defines the transformation of the coordinate system in the device as defined by <i>@Name</i> .
<i>Name</i> Modified in JDF 1.2	NMTOKEN	The name of the <i>TransferCurveSet</i> . Allowed values are: <i>Film</i> – The transformation from the <i>Layout</i> system to the "Film". In a <i>DigitalPrinting</i> environment, this defaults to the identity matrix and the identity <i>TransferCurve</i> . <i>Plate</i> – The transformation from the "Film" system to the "Plate". In a <i>DigitalPrinting</i> environment, this defaults to the identity matrix and the identity <i>TransferCurve</i> . <i>Press</i> – The transformation from the plate system to the "Press". <i>Paper</i> – The transformation from the press system to the final printed substrate such as paper or plastic. <i>Proof</i> – The transformation from the <i>Layout</i> system to the "Proof". New in JDF 1.2

Table 8.277: TransferCurveSet Element (Sheet 2 of 2)

NAME	DATA TYPE	DESCRIPTION
TransferCurve * Modified in JDF 1.1	refelement	List of TransferCurve entries.

8.160 TransferFunctionControl

Resource Properties

Resource Class: Parameter
 Resource referenced by: [SeparationControlParams](#)
 Input of Processes: [ContoneCalibration](#)

Table 8.278: TransferFunctionControl Resource

NAME	DATA TYPE	DESCRIPTION
TransferFunctionSource Modified in JDF 1.3	enumerations	Identifies the source of transfer curves which are to be applied during separation. Allowed values are: Custom – Use the transfer curves provided in TransferCurvePool . Device – Use transfer functions provided by the output device. When Separation is being performed pre-RIP, this can mean that no transfer curves will be applied. Document – Use the transfer curves provided in the document. Modification note: Starting with JDF 1.3 , the data type changes from enumeration to enumerations. If multiple values are specified, the transfer functions that are specified by the individual enumeration values are concatenated.
TransferCurvePool ?	refelement	Provides a set of transfer curves to be used by the process.

8.161 TrappingDetails

[TrappingDetails](#) identifies the root of the hierarchy of resources. This hierarchy controls the [Trapping](#) process, whether used for PDL or in-RIP trapping.

Resource Properties

Resource Class: Parameter
 Example Partition: "DocIndex", "RunIndex", "RunTags", "DocTags", "PageTags", "SetTags", "SheetName", "Side", "SignatureName"
 Input of Processes: [Trapping](#)

Table 8.279: TrappingDetails Resource (Sheet 1 of 2)

NAME	DATA TYPE	DESCRIPTION
DefaultTrapping = "false"	boolean	If "true", pages that have no defined TrapRegion elements are trapped using the set of TrimmingParams . The bleed box is used for the trap zone. If "false", only pages that have TrapRegion elements are trapped.
IgnoreFileParams = "true" Deprecated in JDF 1.4	boolean	If "true", any detectable trapping controls (or traps) provided within any source files used by this process are ignored. If "false", trapping controls embedded in the source files are honored. Note that if TrappingDetails (and the Trapping process) is not present, then the trapping defined in PostScript MAY still be applied. Deprecation note: Starting with JDF1.4 , the application of trap annotations is specified in InterpretingParams/PDFInterpretingParams/@PrintTrapAnnotations .
Trapping ? Deprecated in JDF 1.2	boolean	If "true", trapping is enabled. If "false", trapping is disabled. Use @NoOp in JDF 1.2 and above.
TrappingType ? Deprecated in JDF 1.2	integer	Identifies the trapping method to be used by the Trapping process. The number identifies the minor (last three digits) and major (any digits prior to the last three) version of the trapping type requested.

Table 8.279: TrappingDetails Resource (Sheet 2 of 2)

NAME	DATA TYPE	DESCRIPTION
ObjectResolution * New in JDF 1.1	element	Elements which define the resolutions at which to trap the contents. More than one element MAY be used to specify different resolutions for different @SourceObjects types.
TrappingOrder ?	element	Trapping processes will trap colorants as if they are laid down on the media in the order specified in @TrappingOrder. The colorant order can affect which colors to spread, especially when opaque inks are used.
TrappingParams ?	refelement	A TrappingParams resource that is used to define the default trapping parameters when @DefaultTrapping="true".
TrapRegion *	refelement	A set of TrapRegion resources that identify the pages to be trapped, the geometry of the areas to trap on each page, and the trapping settings to use for each area.

8.161.1 TrappingOrder

Table 8.280: TrappingOrder Element

NAME	DATA TYPE	DESCRIPTION
SeparationSpec * Modified in JDF 1.2	element	An array of colorant names.

8.162 TrappingParams

TrappingParams provides a set of controls that are used to generate traps that are used to avoid mis-registration. The values of the parameters are chosen based on the customer’s trapping strategy, and depend largely on the content of the pages to be trapped and the characteristics of the output device (or press).

Resource Properties

Resource Class: Parameter

Resource referenced by: **TrapRegion, TrappingDetails**

Example Partition: "DocIndex", "RunIndex", "RunTags", "DocTags", "PageTags", "SetTags", "SheetName", "Side", "SignatureName"

Input of Processes:

Table 8.281: TrappingParams Resource (Sheet 1 of 3)

NAME	DATA TYPE	DESCRIPTION
BlackColorLimit ?	double	A number between 0 and 1 that specifies the lowest color value needed for trapping a colorant according to the black trapping rule. This entry uses the subtractive notion of color, where 0 is white or no colorant, and 1 is full colorant.
BlackDensityLimit ?	double	A positive number that specifies the lowest neutral density of a colorant for trapping according to the black trapping rule.
BlackWidth ?	double	A positive number that specifies the trap width for trapping according to the black trapping rule. The @BlackWidth is specified in @TrapWidth units; a value of "1" means that the black trap width is one @TrapWidth wide. The resulting black trap width is subject to the same device limits as @TrapWidth.
Enabled ? Deprecated in JDF 1.2	boolean	If "true", trapping is enabled for zones that are defined with this parameter set. Use @NoOp in JDF 1.2 and above.
HalftoneName ?	string	A name that identifies a halftone object to be used when marking traps. The name is the value of the @ResourceName attribute of some PDLResourceAlias resource. If absent, the halftone in effect just before traps are marked will be used, which MAY cause unexpected results.

Table 8.281: TrappingParams Resource (Sheet 2 of 3)

NAME	DATA TYPE	DESCRIPTION
ImageInternalTrapping?	boolean	If "true", the planes of color images are trapped against each other. If "false", the planes of color images are not trapped against each other.
ImageMaskTrapping?	boolean	Controls trapping when the @TrapZone contains a stencil mask. A stencil mask is a monochrome image in which each sample is represented by a single bit. The stencil mask is used to paint in the current color: image samples with a value of "1" are marked, samples with a value of "0" are not marked. When "false", none of the objects covered by the clipped bounding box of the stencil mask are trapped. No traps are generated between the stencil mask and objects that the stencil mask overlays. No traps are generated between objects that overlay the stencil mask and the stencil mask. For all other objects, normal trapping rules are followed. Two objects on top of the stencil mask that overlap each other might generate a trap, regardless of the value of this parameter. When "true", objects are trapped to the stencil mask, and to each other.
ImageResolution?	integer	A positive integer indicating the minimum resolution, in dpi, for downsampled images. Images can be downsampled by a power of 2 before traps are calculated. The downsampled image is used only for calculating traps, while the original image is used when printing the image.
ImageToImageTrapping?	boolean	If "true", traps are generated along a boundary between images. If "false", this kind of trapping is not implemented.
ImageToObjectTrapping?	boolean	If "true", images are trapped to other objects. If "false", this kind of trapping is not implemented.
ImageTrapPlacement?	enumeration	Controls the placement of traps for images. Allowed values are: Center – Trap is centered on the edge between the image and the adjacent object. Choke – Trap is placed in the image. Normal – Trap is based on the colors of the areas. Spread – Trap is placed in the adjacent object.
ImageTrapWidth? New in JDF 1.2	double	Specifies in points the width of image-to-image, image-to-object and/or image internal non-black traps in X direction (horizontal) of the PDF or ByteMap defined in the input RunList when @ImageToImageTrapping , @ImageToObjectTrapping and/or @ImageInternalTrapping are set to "true". The parameter applies only to non-black traps if an image color on either side qualifies as black. The effective black trap width is used to compute the size of the trap. This is based on @TrapWidth , @BlackWidth and @MinimumBlackWidth . Values SHALL be greater than or equal to zero. A value of 0.0 disables non-black image trapping. Defaults to @TrapWidth .
ImageTrapWidthY? New in JDF 1.2	double	Specifies in points the width of image-to-image, image-to-object and/or image internal non-black traps in Y direction (vertical) of the PDF or ByteMap defined in the input RunList when @ImageToImageTrapping , @ImageToObjectTrapping and/or @ImageInternalTrapping are set to "true". The parameter applies only to non-black traps if an image color on either side qualifies as black. The effective black trap width is used to compute the size of the trap. This is based on @TrapWidth , @BlackWidth and @MinimumBlackWidth . Values SHALL be greater than or equal to zero. A value of 0.0 disables non-black image trapping. Defaults to @ImageTrapWidth .
MinimumBlackWidth = "0"	double	Specifies the minimum width, in points, of a trap that uses black ink. Allowable values are those greater than or equal to zero.
SlidingTrapLimit?	double	A number between 0 and 1. Specifies when to slide traps towards a center position. If the neutral density of the lighter area is greater than the neutral density of the darker area multiplied by the @SlidingTrapLimit , then the trap slides. This applies to vignettes and non-vignettes. No slide occurs at "1".

Table 8.281: TrappingParams Resource (Sheet 3 of 3)

NAME	DATA TYPE	DESCRIPTION
<i>StepLimit</i> ? Modified in JDF 1.2	double	A non-negative number. Specifies the smallest step needed in the color value of a colorant to trigger trapping at a given boundary. If the higher color value at the boundary exceeds the lower value by an amount that is equal to or greater than the larger of 0.05 or @StepLimit times the lower value, i.e. if $Value_{hi} \geq Value_{lo} + \max (@StepLimit * Value_{lo}, 0.05)$ then the edge is a candidate for trapping. The value 0.05 is set to avoid trapping light areas in vignettes. This entry is used if @StepLimit is not specified explicitly by a <i>ColorantZoneDetails</i> subelement for a colorant. The restriction that @StepLimit be less than or equal to one (≤ 1) was removed in JDF 1.2 .
<i>TrapColorScaling</i> ?	double	A number between 0 and 1. Specifies a scaling of the amount of color applied in traps towards the neutral density of the dark area. A value of "1" means the trap has the combined color values of the darker and the lighter area. A value of "0" means the trap colors are reduced so that the trap has the neutral density of the darker area. This entry is used if @TrapColorScaling is not specified explicitly by a <i>ColorantZoneDetails</i> subelement for a colorant.
<i>TrapEndStyle</i> ?= "Miter"	NMTOKEN	Instructs the trap engine how to form the end of a trap that touches another object. Values include: Miter Overlap Note: Other values might be added later from customer requests.
<i>TrapJoinStyle</i> ?= "Miter"	NMTOKEN	Specifies the style of the connection between the ends of two traps created by consecutive segments along a path. Values include: Bevel Miter Round
<i>TrapWidth</i> ? Modified in JDF 1.2	double	Specifies the trap width in the X direction (horizontal) PDF or <i>ByteMap</i> defined in the input <i>RunList</i> . Also defines the unit used in trap width specifications for certain types of objects such as @BlackWidth.
<i>TrapWidthY</i> ? New in JDF 1.2	double	Specifies the trap width, in points in Y direction (vertical). Also defines the unit used in trap width specifications for certain types of objects such as @BlackWidth. If not specified, defaults to the value of @TrapWidth.
<i>ColorantZoneDetails</i> *	element	<i>ColorantZoneDetails</i> subelements. Entries in this dictionary reflect the results of any named colorant aliasing specified. Each entry defines parameters specific for one named colorant. If the colorant named is neither listed in the <i>ColorantParams</i> array nor implied by the @ProcessColorModel for the <i>ColorantControl</i> object in effect when these <i>TrappingParams</i> are applied, the entry is not used for trapping.

8.162.1 ColorantZoneDetails

Table 8.282: ColorantZoneDetails Element (Sheet 1 of 2)

NAME	DATA TYPE	DESCRIPTION
<i>Colorant</i>	string	The colorant name that occurs in the <i>SeparationSpec</i> / <i>@Name</i> of the <i>ColorantParams</i> array of the <i>ColorantControl</i> object used by the process.

Table 8.282: ColorantZoneDetails Element (Sheet 2 of 2)

NAME	DATA TYPE	DESCRIPTION
<i>StepLimit</i> ?	double	A number between 0 and 1. Specifies the smallest step specified in the color value of a colorant to trigger trapping at a given boundary. If the higher color value at the boundary exceeds the lower value by an amount that is equal to or greater than the larger of 0.05 or <i>@StepLimit</i> times the lower value ($low + \max(@StepLimit * low, 0.05)$), then the edge is a candidate for trapping. The value 0.05 is set to avoid trapping light areas in vignettes. If omitted, the <i>@StepLimit</i> attribute in the <i>TrappingParams</i> resource is used.
<i>TrapColorScaling</i> ?	double	A number between 0 and 1. Specifies a scaling of the amount of color applied in traps towards the neutral density of the dark area. A value of "1" means the trap has the combined color values of the darker and the lighter area. A value of "0" means the trap colors are reduced so that the trap has the neutral density of the darker area. If omitted, the <i>@TrapColorScaling</i> attribute in the <i>TrappingParams</i> resource is used.

8.163 TrapRegion

TrapRegion identifies a set of pages to be trapped, an area of the pages to trap, and the parameters to use.

Resource Properties

Resource Class: Parameter

Resource referenced by: *TrappingDetails*

Table 8.283: TrapRegion Resource

NAME	DATA TYPE	DESCRIPTION
<i>Pages</i>	IntegerRangeList	Identifies a set of pages from the <i>RunList</i> to trap using the specified geometry and trapping style. The logical indices that <i>@Pages</i> reference in a <i>RunList</i> are referenced in the same way as <i>Layout/ContentObject/@Ord</i> does. For details, see ▶ Section 8.84.17.4 Using Ord to Reference Elements in RunList Resources.
<i>TrapZone</i> ?	PDFPath	Each element within <i>@TrapZone</i> is one subpath of a complex path. The <i>@TrapZone</i> is the area that results when the paths are filled using the non-zero winding rule. When absent, the MediaBox array for the <i>RunList</i> defines the <i>@TrapZone</i> .
<i>TrappingParams</i> ?	refelement	The set of trapping parameters which will be used when trapping in this region.

8.164 TrimmingParams

TrimmingParams provides the parameters for the **Trimming** process.

Resource Properties

Resource Class: Parameter

Input of Processes: **Trimming**

Table 8.284: TrimmingParams Resource (Sheet 1 of 2)

NAME	DATA TYPE	DESCRIPTION
<i>Height</i> ?	double	Height of the trimmed product.
<i>TrimCover</i> = "Both" New in JDF 1.3	enumeration	Specifies the covers to be trimmed. Covers containing flaps are generally not trimmed. Allowed values are: Back – Trim back cover only. Both – Trim front and back cover. Front – Trim front cover only. Neither – Do not trim cover.
<i>TrimmingOffset</i> ?	double	Amount to be cut from the bottom side.

Table 8.284: *TrimmingParams* Resource (Sheet 2 of 2)

NAME	DATA TYPE	DESCRIPTION
<i>TrimmingType</i> ? New in JDF 1.1 Deprecated in JDF 1.2	enumeration	Trimming operation to perform. Allowed values are: <i>Detailed</i> – Cut the amount specified by <i>@Height</i> , <i>@Width</i> and <i>@TrimmingOffset</i> . <i>SystemSpecified</i> – Cut the amount specified by the system.
<i>Width</i> ?	double	Width of the trimmed product.

8.165 UsageCounter

New in JDF 1.3

Many devices use counters to track equipment utilization or work performed, such as impressions produced or variable data documents generated. Since such usage counters are often used for software and/or hard-ware billing, a mechanism is needed to allow such usage counters to be tracked by MIS for device utilization statistics and/or costing. The *UsageCounter* resource represents a type of equipment or software usage that is tracked by the value of a usage counter used by a device to record the amount of work performed. The attributes of this resource indicate what the usage counter is counting. The *UsageCounter* elements are modeled as *Consumable Resources*, so that standard counting can be used. See ▶ Section 3.10.4 Resource Amount. The section has details on tracking *@Amount* and *@ActualAmount*, Default units are “countable objects”. See ▶ Section 1.6.1 Units of measurement.

Resource Properties

Resource Class: **Consumable**

Input of Processes: **Any Process**

Table 8.285: *UsageCounter* Resource

NAME	DATA TYPE	DESCRIPTION
<i>CounterID</i> ?	string	The ID of this counter as defined by the counting device.
<i>CounterTypes</i> ?	NMTOKENS	This attribute indicates the types of usage being counted by the <i>UsageCounter</i> . Values include: <i>Insert</i> – Post fuser inserter. <i>OneSided</i> – Includes one sided counts. <i>TwoSided</i> – Includes two sided counts. <i>NormalSize</i> – Includes normal size counts. <i>LargeSize</i> – Includes large size counts. <i>Black</i> – Includes black colorant only counts. <i>Color</i> – Includes one or more non-black, non-highlight color colorants counts. <i>Blank</i> – Includes entirely blank counts. <i>HighlightColor</i> – Includes highlight colorant counts. <i>User</i> – Includes counts reflecting work requested by the user (e.g., counts produced by processing the document supplied by the user, as opposed to Auxiliary and Waste). <i>Auxiliary</i> – Includes all counts for work not requested by the user (e.g., banner, confirmation, slip, separator, error log).
<i>Scope</i>	enumeration	The scope of this usage counter. Allowed values are: <i>Job</i> – Count in the context of one JDF . <i>Lifetime</i> – Count since machine last had a firmware reset. SHALL NOT be specified when <i>UsageCounter</i> is used as a resource in a JDF ticket. <i>PowerOn</i> – Count since the machine was powered on. SHALL NOT be specified when <i>UsageCounter</i> is used as a resource in a JDF ticket.

8.166 VarnishingParams

New in JDF 1.4

VarnishingParams provides the parameters of a *Varnishing* process.

Resource Properties

Resource Class: Parameter

Intent Pairing: [ColorIntent](#)Input of Processes: [Varnishing](#)

Table 8.286: VarnishingParams Resource

NAME	DATA TYPE	DESCRIPTION
ModuleIndex ?	integer	Index of the varnishing module in a multi-function device, such as a printing press. See Module for details. In a combined process, all modules of the device, including press modules, finishing modules and varnishing modules are counted to calculate @ModuleIndex . Only one of @ModuleIndex or @ModuleType MAY be specified.
ModuleType ?	NMTOKEN	The type of module used to apply the varnish. Only one of @ModuleIndex or @ModuleType MAY be specified. Values include those from: ▶ Module Types.
VarnishArea ?	enumeration	Area to be varnished. @VarnishArea specifies the requirements for ExposedMedia . Allowed values are: Full – The entire media surface SHALL be varnished. Spot – Only parts of the media surface SHALL be varnished.
VarnishMethod ?	enumeration	Method used for varnishing. Allowed values are: Blanket – Varnishing is performed in a dedicated coating module. An ExposedMedia that references a Media/@MediaType="Blanket" MAY be specified. Independent – No additional ExposedMedia is required. This method MAY be used to specify varnishing in a digital press. Plate – Varnishing is performed in a print module or a dedicated coating module. An ExposedMedia that references a Media/@MediaType="Plate" SHOULD be specified.

8.167 VerificationParams

[VerificationParams](#) provides the parameters of a [Verification](#) process.

Resource Properties

Resource Class: Parameter

Input of Processes: [Verification](#)

Table 8.287: VerificationParams Resource (Sheet 1 of 2)

NAME	DATA TYPE	DESCRIPTION
FieldRange ? Deprecated in JDF 1.5	IntegerRangeList	Zero-based range list of integers that determines which characters of the data in IdentificationField are to be applied to the field formatting strings. If not specified all characters are applied. Deprecation note: Starting with JDF 1.5, use IdentificationField/@ValueFormat and IdentificationField/@ValueTemplate .
InsertError Deprecated in JDF 1.5	string	Database insertion statement in C printf format defining how information read from the resource of the Verification process SHALL be stored in case of verification errors. The database is defined by the DBSelection resource of the Verification process. This field SHALL be specified if a database is selected. Deprecation note: Starting with JDF 1.5, use FileSpec(Accepted) .
InsertOK ? Deprecated in JDF 1.5	string	Database insertion statement in C printf format defining how information extracted from the IdentificationField SHALL be stored in case of verification success. The database is defined by the DBSelection resource of the verification node. This field SHALL be specified if a database is selected. Deprecation note: Starting with JDF 1.5, use FileSpec(Rejected)

Table 8.287: VerificationParams Resource (Sheet 2 of 2)

NAME	DATA TYPE	DESCRIPTION
<i>Tolerance</i> ?	double	Ratio of tolerated verification failures to the total number of tests. "0.0" = no failures allowed, "1.0" = all tests MAY fail.

8.168 WebInlineFinishingParams

New in JDF 1.3

WebInlineFinishingParams specifies the parameters for web inline finishing equipment using the **WebInlineFinishing** process.

Resource Properties

Resource Class: Parameter

Example Partition: "SubRun", "WebName", "RibbonName", "WebProduct"

Input of Processes: **WebInlineFinishing**

Table 8.288: WebInlineFinishingParams Resource

NAME	DATA TYPE	DESCRIPTION
<i>FolderProduction</i> *	element	Specifies the folder setup for newspaper presses.

8.168.1 FolderProduction

Table 8.289: FolderProduction Element

NAME	DATA TYPE	DESCRIPTION
<i>FolderModuleIndex</i> ?	integer	Identifies a particular folder module to be used. @ <i>FolderModuleIndex</i> SHALL match <i>Device/Module/@ModuleIndex</i> .
<i>ProductionType</i> = "NonCollect"	enumeration	Indicates whether the product is collected or not. Allowed values are: Collect NonCollect

8.169 WindingParams

New in JDF 1.5

The parameters for the **Winding** process.

Resource Properties

Resource Class: Parameter

Input of Processes: **Winding**

Table 8.290: WindingParams Resource

NAME	DATA TYPE	DESCRIPTION
<i>Copies</i> ?	integer	Number of copies in one column that SHOULD be placed on a finished roll. At most, one of @ <i>Copies</i> , @ <i>Diameter</i> or @ <i>Length</i> SHOULD be specified.
<i>Diameter</i> ?	double	Outer diameter in points of the finished roll. At most one of @ <i>Copies</i> , @ <i>Diameter</i> or @ <i>Length</i> SHOULD be specified.
<i>Fixation</i> ?	NMTOKEN	Method specifying how the Component is attached to the core. Values include: <i>DoubleSidedTape</i> – Tape with adhesive on both sides. <i>Glue</i> <i>Label</i> – One of the output Component resources (self-adhesive labels) is used. <i>None</i> – No fixation is used. <i>SingleSidedTape</i> – Tape with adhesive on one side.
<i>Length</i> ?	double	Length in points of the Component to be placed on a finished roll. At most one of @ <i>Copies</i> , @ <i>Diameter</i> or @ <i>Length</i> SHOULD be specified.

8.170 WireCombBindingParams

WireCombBindingParams describes the details of the **WireCombBinding** process.

Resource Properties

Resource Class: Parameter

Intent Pairing: [BindingIntent](#)

Input of Processes: **WireCombBinding**

Table 8.291: WireCombBindingParams Resource

NAME	DATA TYPE	DESCRIPTION
Brand ?	string	The name of the comb manufacturer (e.g., <i>Wire-O</i> [®]) and the name of the specific item.
Color ?	enumeration	Determines the color of the comb. Allowed value is from: ▶ NamedColor .
ColorDetails ? New in JDF 1.4	string	A more specific, specialized or site-defined name for the color. If @ColorDetails is supplied, @Color SHOULD also be supplied.
Diameter ?	double	The comb diameter is determined by the height of the block of sheets to be bound.
Distance ? Deprecated in JDF 1.2	double	The distance between the “teeth” and the distance between the holes of the pre-punched sheets SHALL be the same. In JDF 1.2 and beyond, use the value implied by HoleMakingParams / @HoleType .
FlipBackCover = "false" New in JDF 1.1	boolean	The spine is typically hidden between the last page of the Component and the back cover. Flip the back cover after the wire was “closed” or keep it open. The latter makes sense if further processing is needed (e.g., inserting a CD) before closing the book.
Material ?	enumeration	The material used for forming the wire comb binding. Allowed values are: LaqueredSteel TinnedSteel ZincsSteel
Shape ="Single" Modified in JDF 1.6	NMTOKEN	The shape of the wire comb. Values include: Single – Each “tooth” is made with one wire. SingleCalendar – Each “tooth” is made with one wire and an extension for hanging the bound product is provided in the center. New in JDF 1.6 Twin – The shape of each “tooth” is made with a double wire. TwinCalendar – The shape of each “tooth” is made with a double wire and an extension for hanging the bound product is provided in the center. New in JDF 1.6
Thickness ?	double	The thickness of the comb material.
HoleMakingParams ? New in JDF 1.2	refelement	Details of the holes in WireCombBinding .

8.171 WrappingParams

New in JDF 1.1

WrappingParams defines the details of **Wrapping**. Details of the material used for **Wrapping** can be found in the [Media](#) resource that is an input of the **Wrapping** process.

Resource Properties

Resource Class: Parameter

Intent Pairing: [PackingIntent](#)

RESOURCES

Input of Processes: **Wrapping**

Table 8.292: *WrappingParams* Resource

NAME	DATA TYPE	DESCRIPTION
<i>WrappingKind</i> ?	enumeration	<i>@WrappingKind</i> specifies the wrapping method. Allowed values are: <i>Band</i> – The components are wrapped with a band. The material of the band is typically paper, plastic or rubber. <i>LooseWrap</i> – The wrap is loose around the component. <i>ShrinkWrap</i> – The wrap is shrunk around the component.

9 Subelements

The elements in this chapter are subelements that can occur in multiple resources. They are not resources and are therefore never directly linked to processes.

9.1 Address

Definition of an address. The structure is derived from the vCard format and, therefore, is comprised of all address subtypes (ADR:) of the delivery address of the vCard format. The corresponding XML types of the vCard fields are quoted in the table.

Element Properties

Element referenced by: [Location](#), [Contact](#), [Person](#)

Table 9.1: Address Element

NAME	DATA TYPE	DESCRIPTION
AddressUsage ? New in JDF 1.6	NMTOKEN	@AddressUsage specifies the intended use of the address. Values include: Business - Business company address. Residence - Private home address.
City ?	string	City or locality of the Address (vCard: ADR:locality).
CivicNumber ?	string	@CivicNumber SHALL specify the street number of the street address. If @CivicNumber is specified, it SHALL NOT be included in @Street.
Country ?	string	Country code of the Address (vCard: ADR:country).
CountryCode ?	NMTOKEN	Country of the Address . Values include those from: ▶ [ISO/NP 3166-1:2013].
PostalCode ?	string	Zip code or postal code of the Address (vCard: ADR:pcode).
PostBox ?	string	Post office address (vCard: ADR:pobox. For example: P.O. Box 101).
Region ?	string	State or province of the Address (vCard: ADR:region).
Street ?	string	Street of the Address (vCard: ADR:street). @Street SHALL include the name of the street and SHOULD include the street number unless the street number is specified separately in @CivicNumber.
AddressLine * New in JDF 1.6	element	Each AddressLine element SHALL specify one line of a printed address. If AddressLine is provided, the complete address SHALL be provided as an ordered sequence of AddressLine elements.
ExtendedAddress ?	element	Extended address (vCard: ADR:extadd. For example: Suite 245).

9.1.1 AddressLine

[AddressLine](#) represents an individual address line.

Note: An address may be encoded as attributes (e.g. @City, @Street, etc), text elements in [AddressLine](#), or both. The latter case may occur where the original database does not provide all the individual details of the address.

Table 9.2: AddressLine Element

NAME	DATA TYPE	DESCRIPTION
	text	Text content of the AddressLine .

9.1.2 ExtendedAddress

Table 9.3: ExtendedAddress Element

NAME	DATA TYPE	DESCRIPTION
	text	Text content of the <i>ExtendedAddress</i> .

9.2 AutomatedOverPrintParams

AutomatedOverPrintParams provides controls for the automated selection of overprinting of black text or graphics. *@RGBGray2Black* and *@RGBGray2BlackThreshold* in *ColorSpaceConversion/ColorSpaceConversionOp* are used by the *ColorSpaceConversion* process in determining the allocation of RGB values to the black (K) channel. After the *ColorSpaceConversion* process is completed, then the *Rendering* or *Separation* process uses *AutomatedOverPrintParams* to determine overprint behavior for the previously determined black (K) channel.

Element Properties

Element referenced by: *ElementColorParams, RenderingParams, SeparationControlParams*

Table 9.4: AutomatedOverPrintParams Element

NAME	DATA TYPE	DESCRIPTION
<i>KnockOutCMYKWhite</i> = "false" New in JDF 1.3	boolean	If <i>@KnockOutCMYKWhite</i> ="true", graphic objects defined in DeviceCMYK, where all colorant values are <0.001 SHALL be knocked out, even when set to overprint and when the PDF overprint mode is set to 1.
<i>LineArtBlackLevel</i> ?	double	A value between 0.0 and 1.0 that indicates the minimum black level for the stroke or fill colors that cause the line art to be set to overprint. Defaults to the value of <i>@TextBlackLevel</i> . <i>@LineArtBlackLevel</i> SHALL NOT be specified unless <i>@OverPrintBlackLineArt</i> ="true".
<i>OverPrintBlackLineArt</i> = "false"	boolean	Indicates whether overprint SHALL be set to "true" for black line art (i.e., vector elements other than text). If "true", overprint of black line art is applied regardless of any values in the PDL. If "false", <i>@LineArtBlackLevel</i> is ignored and PDL line art overprint operators are processed.
<i>OverPrintBlackText</i> = "false"	boolean	Indicates whether overprint SHALL be set to "true" for black text. If "true", overprint of black text is applied regardless of any values in the PDL. If "false", <i>@TextSizeThreshold</i> and <i>@TextBlackLevel</i> are ignored and PDL text overprint operators are processed.
<i>TextBlackLevel</i> = "1"	double	A value between 0.0 and 1.0 that indicates the minimum black level for the text stroke or fill colors that cause the text to be set to overprint. <i>@TextBlackLevel</i> SHALL NOT be specified unless <i>@OverPrintBlackText</i> ="true".
<i>TextSizeThreshold</i> ?	integer	Indicates the point size for text below which black text will be set to overprint. For asymmetrically scaled text, the minimum point size between both axes SHALL be used. If not specified, all text is set to overprint. <i>@TextSizeThreshold</i> SHALL NOT be specified unless <i>@OverPrintBlackText</i> ="true".

9.3 BarcodeCompParams

New in JDF 1.3

BarcodeCompParams specifies the technical compensation parameters for barcodes.

Element Properties

Element referenced by: *BarcodeReproParams*

Table 9.5: BarcodeCompParams Element (Sheet 1 of 2)

NAME	DATA TYPE	DESCRIPTION
<i>CompensationProcesses</i>	enumeration	Process that is bar width spread SHALL be compensated for. Allowed values are: Platemaking Printing

Table 9.5: BarcodeCompParams Element (Sheet 2 of 2)

NAME	DATA TYPE	DESCRIPTION
<i>CompensationValue</i>	double	The width of the bars SHALL be reduced by this amount (in microns) to compensate for technical spread.

9.4 BarcodeReproParams

New in JDF 1.3

BarcodeReproParams specifies the reproduction parameters for barcodes.

Element Properties

Element referenced by: /*LayoutElementPart/BarcodeProductionParams, DeviceMark*

Table 9.6: BarcodeReproParams Element

NAME	DATA TYPE	DESCRIPTION
<i>BearerBars</i> ?	enumeration	<i>@BearerBars</i> specifies how to generate bearer bars. (ITF). Allowed values are: Box BoxHMarks None TopBottom
<i>Height</i> ?	double	<i>@Height</i> SHALL specify the height (Y direction) of the bars of a linear barcode in the PDL.
<i>Magnification</i> ?	double	The magnification factor that linear barcodes SHALL be scaled with. For example, a value for <i>@Magnification</i> > 1 requests thicker barcode lines in the resulting PDL.
<i>Masking</i> ?	enumeration	Indicates the properties of the mask around the graphical content of the barcode that masks out all underlying graphics. Allowed values are: None – No masking, the barcode is put on top of underlying graphics. WhiteBox – An area of the underlying graphics SHALL be masked out (the white box) and the barcode SHALL be put on top of this masked area. The area of the white box SHALL be the box enclosing all artwork of the barcode, excluding optional human readable text. The box SHALL enclose bearer bars, quiet zones and non-optional human readable text (UPC and EAN barcodes).
<i>ModuleHeight</i> ?	double	The Y size in microns of an element of a 2D barcode (e.g., PDF417). For DATAMATRIX, Y dimension MAY be omitted (X dimension = Y dimension).
<i>ModuleWidth</i> ?	double	The X size in microns of an element of a 2D barcode such as DATAMATRIX or PDF417.
<i>Ratio</i> ?	double	The ratio between the width of the narrow bars and the wide bars for those barcodes where the ratio of the width of the wide bars to the narrow bars MAY vary.
<i>BarcodeCompParams</i> *	element	Parameters for bar width compensation. The total reduction of bar width SHALL be the sum of all <i>BarcodeCompParams/@CompensationValue</i> .

9.5 Certification

New in JDF 1.6

Certification specifies the certification properties of paper.

Element Properties

Element referenced by: [MediaIntent](#), [Media](#)

Table 9.7: Certification Element

NAME	DATA TYPE	DESCRIPTION
Claim ?	string	Name of the certification as defined by the issuing organization. Values include: FSC 100% FSC Mix 70% FSC Mix Credit FSC Recycled 85% FSC Recycled Credit PEFC nn% PEFC Certified PEFC Recycled
Identifier ?	string	Certification identification number as defined by the issuing organization.
Organization ?	NMTOKEN	Identifier of the issuing organization: Values include: CFCC – China's National Forest Certification System FSC – Forest Stewardship Council IFCC – Sustainable Forest Management Requirements PEFC – The Programme for the Endorsement of Forest Certification

9.6 ColorantAlias

[ColorantAlias](#) is an element that specifies a replacement colorant name string to be used instead of one or more named colorant strings. For example, [SeparationSpec](#)/[@Name](#) = "Pantone 135 C", "PANTONE 135" and [@ReplacementColorantName](#) = "PANTONE 135 C" maps string values: "Pantone 135 C" and "PANTONE 135" to the string value: "PANTONE 135 C".

Element Properties

Element referenced by: [ColorantControl](#), [ElementColorParams](#)

Table 9.8: ColorantAlias Element

NAME	DATA TYPE	DESCRIPTION
RawNames ? New in JDF 1.4	hexBinaryList	Whitespace-separated list of hexBinary values. Each token represents the original 8-bit byte stream of the color specified in SeparationSpec . Used to transport the original byte representation of a color name when moving JDF tickets between computers with different locales. Exactly one token SHALL be specified for each SeparationSpec in this ColorantAlias . The order of tokens SHALL be identical to the order of the related SeparationSpec .
ReplacementColorantName	string	The value of the colorant name string to be substituted for the colorant name in the SeparationSpec resource list.
SeparationSpec + Modified in JDF 1.2	element	The names of the colorants to be replaced in PDL files.

Example 9.1: [ColorantAlias/@RawNames](#)

New in JDF 1.4

```
<ColorantAlias Class="Parameter" ID="r000004"
  RawNames="4772FC6E 6772FC6E" ReplacementColorantName="Green" Status="Available">
  <!-- ColorantAlias that maps the additional representation (grün, Grün)
    to the predefined separation Green -->
  <SeparationSpec Name="Grün"/>
  <SeparationSpec Name="grün"/>
</ColorantAlias>
```

9.7 ColorCorrectionOp

Element Properties

Element referenced by: [ColorCorrectionParams](#), [ElementColorParams](#)

Table 9.9: ColorCorrectionOp Element

NAME	DATA TYPE	DESCRIPTION
AdjustContrast ? New in JDF 1.2	double	Specifies the L*a*b* contrast adjustment in the range -100 (minimum contrast for the system (i.e., a solid midtone gray color)) to + 100 (maximum contrast for the system (i.e., either use full color (the maximum is restricted by the system ink limit) or no color for each of Cyan, Magenta, Yellow and Black)). Increasing the contrast value increases the variation between light and dark areas and decreasing the contrast value decreases the variation between light and dark areas. See explanation above.
AdjustCyanRed ? New in JDF 1.2	double	Specifies the L*a*b* adjustment in the Cyan/Red axis in the range -100 (maximum Cyan cast for the system) to + 100 (maximum Red cast for the system) while maintaining lightness. See explanation above.
AdjustHue ? New in JDF 1.2	double	Specifies the change in the L*a*b* hue in the range -180 to +180 of all colors by the specified number of degrees of the color circle. See explanation above.
AdjustLightness ? New in JDF 1.2	double	Specifies the decrease or increase of the L*a*b* lightness in the range -100 (minimum lightness for the system (i.e., black)) to + 100 (maximum lightness for the system (i.e., white)). Increasing the lightness value causes the output to appear lighter and decreasing the lightness value causes the output to appear darker. See explanation above.
AdjustMagentaGreen ? New in JDF 1.2	double	Specifies the L*a*b* adjustment in the Magenta/Green axis in the range -100 (maximum Magenta cast for the system) to + 100 (maximum Green cast for the system) while maintaining lightness. See explanation above.
AdjustSaturation ? New in JDF 1.2	double	Specifies the increase or decrease of the L*a*b* color saturation in the range -100 (minimum saturation for the system) to +100 (maximum saturation for the system). Increasing the saturation value causes the output to contain more vibrant colors and decreasing the saturation value causes the output to contain more pastel and gray colors. See explanation above.
AdjustYellowBlue ? New in JDF 1.2	double	Specifies the L*a*b* adjustment in the Yellow/Blue axis in the range -100 (maximum Yellow cast for the system) to + 100 (maximum Blue cast for the system) while maintaining lightness. See explanation above.
ObjectTags ? New in JDF 1.4	NMTOKENS	Tags associated with individual objects that this ColorCorrectionOp SHALL be applied to. Each tag specified in @ObjectTags is logically AND'ed with the object type(s) specified by @SourceObjects , enabling first qualification by object type (such as image), and then tags associated with those objects. The values of @ObjectTags depends on the PDL that the color correction is applied to. @ObjectTags SHALL apply only to objects whose tag pool includes all the tags in the value of @ObjectTags .
SourceObjects ? Modified in JDF 1.6	enumerations	Identifies which class(es) of incoming graphical objects will be operated on. If @SourceObjects is not specified then ColorCorrectionOp shall apply to all object classes. Allowed values are from: ▶ SourceObjects.
FileSpec (AbstractProfile) ? New in JDF 1.2	refelement	A FileSpec resource pointing to an abstract ICC profile that has been devised to apply a preference adjustment. See explanation of adjustment at the beginning of this section.
FileSpec (DeviceLinkProfile) ? New in JDF 1.2	refelement	A FileSpec resource pointing to an ICC profile that describes the characterization of an abstract profile for specifying a preference adjustment. See explanation of adjustment at the beginning of this section.

9.8 ColorMeasurementConditions

New in JDF 1.1

SUBELEMENTS

This element contains information about the specific measurement conditions for spectral or densitometric color measurements. Spectral measurements refer to ▶ [CIE 015:2004] and ▶ [ISO13655:2017]. The default measurement conditions for spectral measurements are illuminant D50 and 2 degree observer.

Density measurements refer to ▶ [ISO5-3:2009] and ▶ [ISO5-4:2009]. The default measurement conditions for densitometric measurements are density standard ISO/ANSI Status T, calibration to absolute white and using no polarization filter.

Element Properties

Element referenced by: [CIELABMeasuringField](#), [Color](#), [CutMark](#), [Media](#)

Table 9.10: ColorMeasurementConditions Element

NAME	DATA TYPE	DESCRIPTION
<i>DensityStandard</i> = "ANSIT"	enumeration	Density filter standard used during density measurements. Allowed values are: ANSIA – ANSI Status A ANSIE – ANSI Status E ANSII – ANSI Status I ANSIT – ANSI Status T DIN16536 DIN16536NB
<i>Illumination</i> = "D50"	enumeration	Illumination used during spectral measurements. Allowed values are: D50 D65 Unknown
<i>InkState</i> ?	enumeration	State of the ink during color measurements. Allowed values are: Dry Wet NA Deprecated in JDF 1.2
<i>Instrumentation</i> ?	string	Specific instrumentation used for color measurements (e.g., manufacturer, model number and serial number).
<i>MeasurementFilter</i> ?	enumeration	Optical filter used during color measurements. Allowed values are: None – No filter used. Pol – Polarization filter used UV – Ultraviolet cut filter used
<i>Observer</i> = "2"	integer	CIE standard observer function (2 degree and 10 degree) used during spectral measurements. Values are in degrees (2 or 10).
<i>SampleBacking</i> ?	enumeration	Backing material used behind the sample during color measurements. Allowed values are: Black White NA Deprecated in JDF 1.2
<i>WhiteBase</i> ?	enumeration	Reference for white calibration used for density measurements. Allowed values are: Absolute – Means the instrument is calibrated to a device specific calibration target (absolute white) for absolute density measurements. Paper – Means the instrument is calibrated relative to paper white

9.9 ColorSpaceConversionOp

The [ColorSpaceConversionOp](#) element identifies a type of object, defines the source color space for that type of object, and specifies the behavior of the conversion operation for that type of object. Many of these attribute descriptions refer to ICC Color Profiles ▶ [ICC.1].

Element Properties

Element referenced by: [ColorSpaceConversionParams](#), [ElementColorParams](#)

Table 9.11: ColorSpaceConversionOp Element (Sheet 1 of 3)

NAME	DATA TYPE	DESCRIPTION
<i>IgnoreEmbeddedICC</i> = "false" Deprecated in JDF 1.4	boolean	If "true", specifies that embedded source ICC profiles SHALL be ignored as part of the selection criteria for this ColorSpaceConversionOp . If "true", FileSpec (PDLSourceProfile) is ignored. Deprecation note: Starting with JDF 1.4 , use the new @SourceCS values of "DeviceGray", "DeviceRGB", or "DeviceCMYK" to select objects having a non characterized color space. Use "Gray", "RGB", or "CMYK" to select objects regardless of whether they are characterized. Use "ICCGray", "ICCRGB", or "ICCCMYK" to select only characterized objects.
<i>ObjectTags</i> ? New in JDF 1.4	NMTOKENS	Tags associated with individual objects that this ColorSpaceConversionOp SHALL be applied to. Each tag specified in @ObjectTags is logically AND'd with the object type(s) specified by @SourceObjects , enabling first qualification by object type (such as image), and then tags associated with those objects. The values of @ObjectTags depends on the PDL that the color space conversion is applied to. @ObjectTags SHALL apply only to objects whose tag pool includes all the tags in the value of @ObjectTags .
<i>Operation</i> ? Modified in JDF 1.2	enumeration	Controls which of five functions the color space conversion utility performs. Allowed values are: Convert – Transforms graphical elements to final target color space. Tag – Associates appropriate working space profile with uncharacterized graphical element. Untag – Removes all profiles and color characterizations from graphical elements. Retag – Equivalent to a sequence of "Untag" -> "Tag", where the "Untag" -> "Tag" sequence is only applied to those objects selected by this ColorSpaceConversionOp . ConvertIgnore – Equivalent to a sequence of "Untag" -> "Convert". Constraint: @Operation SHALL be specified in the context of ColorSpaceConversionParams/ColorSpaceConversionOp and SHALL NOT be specified in the context of ElementColorParams/ColorSpaceConversionOp .
<i>PreserveBlack</i> = "false" New in JDF 1.1	boolean	Controls how the tints of black (K in CMYK) are to be handled. If @PreserveBlack is "false", these colors are processed through the standard ICC workflow. If @PreserveBlack is "true", these colors are to be converted into other shades of black. The algorithm is implementation-specific.
<i>RenderingIntent</i> = "ColorSpaceDependent" Modified in JDF 1.3	enumeration	Identifies the rendering intent to be applied when rendering the objects selected by this ColorSpaceConversionOp . Allowed value is from: ▶ RenderingIntent.
<i>RGBGray2Black</i> = "false" Modified in JDF 1.2	boolean	This feature controls what happens to gray values (R = G = B) when converting from RGB to CMYK or the incoming graphical objects indicated by @SourceObjects . In the case of MS Office applications and screen dumps, there are a number of gray values in the images and line art. Printers do not want to have CMY under the K because it creates registration problems. They prefer to have K only, so the printer converts the gray values to K. Gray values that exceed the @RGBGray2BlackThreshold are not converted. @RGBGray2Black and @RGBGray2BlackThreshold are used by the ColorSpaceConversion process in determining how to allocate RGB values to the black (K) channel. After the ColorSpaceConversion process is completed, the Rendering process uses AutomatedOverPrintParams to determine overprint behavior for the previously determined black (K) channel.

Table 9.11: ColorSpaceConversionOp Element (Sheet 2 of 3)

NAME	DATA TYPE	DESCRIPTION
<p><i>RGBGray2BlackThres hold = "1"</i> New in JDF 1.2</p>	double	<p>A value between "0.0" and "1.0" which specifies the threshold value above which the device SHALL NOT convert gray (R = G = B) to black (K only) when @RGBGray2Black is "true". So a "0" value means convert only R = G = B = 0 (black) to K only. A value of "1" specifies that all values of R = G = B are converted to K if @RGBGray2Black = "true".</p>
<p><i>SourceCS</i> Modified in JDF 1.3</p>	enumeration	<p>Identifies which of the incoming color spaces SHALL be operated on. Allowed values are from: ▶ SourceColorSpace. Note: See ▶ Appendix A.3.52.1 Source color space mapping.</p>
<p><i>SourceObjects</i> ? Modified in JDF 1.6</p>	enumerations	<p>List of object classes that identifies which incoming graphical objects will be operated on. If @SourceObjects is not specified then ColorSpaceConversionOp SHALL apply to all object classes. Allowed values are from: ▶ SourceObjects.</p>
<p><i>SourceRenderingIntent</i> ? New in JDF 1.2</p>	enumeration	<p>Identifies the rendering intent transform elements to be selected from the source profile that will be used to interpret objects of type identified by the @SourceObjects and @SourceCS attributes. Default value is from: @RenderingIntent. Allowed value is from: ▶ RenderingIntent. Note: The @SourceRenderingIntent will pertain to the source profile used in a particular ColorSpaceConversion process (e.g., sources can be the native original color space, an intermediate working color space or an reference output simulation color space).</p>
<p><i>DeviceNSpace</i> ? New in JDF 1.2</p>	element	<p><i>DeviceNSpace</i> resource that describe the DeviceN color space on which to operate when @SourceCS = "DeviceN". Individual colorant definitions for the colorant names given in DeviceNSpace are provided in the ColorantControl/ColorPool resource, which SHALL also be present</p>
<p><i>FileSpec (AbstractProfile)</i> ? New in JDF 1.2 Deprecated in JDF 1.6</p>	refelement	<p>A FileSpec resource pointing to an ICC profile ▶ [ICC.1] that describes the characterization of an abstract profile for specifying a preference adjustment. Deprecation note: In JDF 1.6 and beyond, preference adjustment SHOULD be specified in a ColorCorrection process and the abstract profiles SHOULD be provided as ColorCorrectionOp/FitPolicy(AbstractProfile) .</p>
<p><i>FileSpec (DeviceLinkProfile)</i> * New in JDF 1.3 Modified in JDF 1.4</p>	refelement	<p>A FileSpec resource pointing to an ICC profile file [ICC.1] that contains a device link transform. The source color space of the referenced device link transform SHOULD match that of the profile identified by FileSpec (PDLSourceProfile) and the destination color space SHOULD match that of the destination profile identified by ColorSpaceConversionParams (if specified). Multiple device link ICC transforms SHOULD be provided where each transform specifies a different rendering intent. This is important in the case where multiple PDL content objects of the color space specify different rendering intents. Note: An ICC device link profile contains only one transform with one color rendering intent. Note: Although the ICC specification refers to all ICC files as "profiles", a device link in actuality represents a single transform to be applied, and not a profile of a particular device color space. Thus these files are referred to as device link transforms in this specification. Modification note: Starting with JDF 1.4, multiple FileSpec (DeviceLinkProfile) elements are allowed.</p>
<p><i>FileSpec (PDLSourceProfile)</i> ? New in JDF 1.4</p>	refelement	<p>A FileSpec resource describing an ICC profile that describes a profiled source space that this ColorSpaceConversionOp should operate on. When present, only objects that specify the @SourceCS along with the specified profile are selected. Note: The FileSpec/@UID attribute can often be used to positively identify an ICC profile referenced in a PDL file when available (FileSpec/@UID corresponds to the ICC ProfileID field). In addition, FileSpec/@Checksum may be used when only a checksum of the entire profile is available.</p>

Table 9.11: ColorSpaceConversionOp Element (Sheet 3 of 3)

NAME	DATA TYPE	DESCRIPTION
FileSpec (SourceProfile) ?	reference	A FileSpec resource pointing to an ICC profile ▶ [ICC.1] that describes the assumed source color space. If FileSpec (SourceProfile) is specified, it SHALL be used as the profile for the source object's color space during a "Convert", "Tag", or "Retag" operation, as specified by @Operation. FileSpec (SourceProfile) SHALL be present for "Tag" or "Retag" operations, as specified by @Operation.
ScreenSelector ?	element	Links this ColorSpaceConversionOp to a given screening.
SeparationSpec * New in JDF 1.2	element	SeparationSpec resource(s) defining on which separation(s) to operate when @SourceCS = "Separation".

9.10 ComChannel

A communication channel to a person or company such as an email address, phone number or fax number.

Element Properties

Element referenced by: [Contact](#), [Person](#)

Table 9.12: ComChannel Element

NAME	DATA TYPE	DESCRIPTION
ChannelType Modified in JDF 1.5	enumeration	Type of the communication channel. Allowed values are: ComputerName New in JDF 1.5 Email – Email address. Fax – Fax machine. JMF – JMF messaging channel. Mobile – Mobile phone. New in JDF 1.5 Phone – Telephone number. Starting with JDF 1.5, this SHOULD be restricted to land line phones. Modified in JDF 1.5 WWW – WWW home page or form. PrivateDirectory – Account of a registered customer of a certain service. (The list of the registered accounts is maintained by the service vendor). The @ ChannelTypeDetails attribute has the name of the private directory service vendor. InstantMessaging – IM service address. The @ ChannelTypeDetails attribute has the name of the IM service vendor
ChannelTypeDetails ? New in JDF 1.2 Modified in JDF 1.5	NMTOKEN	Description of the value of the @ ChannelType attribute. Consumer treats this value as the service vendor name if @ ChannelType is "PrivateDirectory" or "InstantMessaging". Values include those from: ▶ Table 9.13 ChannelTypeDetails Attribute – predefined values for certain ChannelType values.
ChannelUsage ? New in JDF 1.2	NMTOKENS	Communication channel usage. Values include: Business – Business purpose usage (e.g., office phone number, fax). Private – Private purpose usage (e.g., private phone number, fax, Email). DayTime – Office hours in the time zone of the recipient. NightTime – Out-of-office hours in the time zone of the recipient. WeekEnd – Out-of-office hours in the time zone of the recipient.
Locator Modified in JDF 1.2	string	Locator of this type of channel in a form, such as a phone number, a URL or an Email address. If a URL is defined for the @ ChannelType , it is RECOMMENDED to use the URL syntax specified in ▶ [RFC6068] for "mailto" URLs, ▶ [RFC3966] for "tel" URLs and ▶ [RFC3986] for URLs in general, as follows: Values include: "mailto:a@b.com" – instead of "a@b.com" if @ ChannelType = "Email", "tel:+49-69-92058800" – if @ ChannelType = "Phone" and "tel:+49.6151.155.299" – if @ ChannelType = "Fax".

9.10.1 ChannelTypeDetails Attribute

Table 9.13: ChannelTypeDetails Attribute – predefined values for certain ChannelType values

CHANNELTYPE VALUE	CHANNELTY PEDETAILS VALUE	DESCRIPTION
"Phone"	"Secure"	Secure phone line.
	"ISDN"	ISDN line telephone number.
"WWW"	"Form"	Upload form.
	"Target"	Upload target URL.

Example 9.2: ComChannel for Telephone

```
<ComChannel ChannelType="Phone" ChannelTypeDetails="Mobile"
  ChannelUsage="Business" Class="Parameter" ID="cc000004"
  Locator="tel:+44-07808-907-919" Status="Available"/>
```

Example 9.3: ComChannel for Instant Messaging

```
<ComChannel ChannelType="InstantMessaging"
  ChannelTypeDetails="MyIMService" ChannelUsage="Private"
  Class="Parameter" ID="cc000004" Locator="123456789" Status="Available"/>
```

9.11 Comment

The **Comment** element can be used to provide human readable text that pertains to the parent element.

Element Properties

Element referenced by: The element can be referenced by all other elements

Table 9.14: Comment Element (Sheet 1 of 2)

NAME	DATA TYPE	DESCRIPTION
<i>AgentName</i> ? New in JDF 1.3	string	The name of the agent application that created the Comment . Both the company name and the product name MAY appear, and SHOULD be consistent between versions of the application.
<i>AgentVersion</i> ? New in JDF 1.3	string	The version of the agent application that created the Comment . The format of the version string MAY vary from one application to another, but SHOULD be consistent for an individual application.
<i>Attribute</i> ? New in JDF 1.1	NMTOKEN	Name of the attribute in the parent element of the Comment element that this Comment refers to. <i>@Attribute</i> SHOULD include the namespace prefix if the attribute is in a non JDF namespace. If omitted, the Comment refers to the entire parent element. <i>@Attribute</i> MAY be used to provide instructions for setting an attribute or to provide additional human readable information. For instance the name for <i>Media/@Dimensions</i> or the name <i>Media/@Weight</i> MAY be localized. Note: <i>@Attribute</i> MAY be specified for attributes of the parent that are not explicitly set in that element. This allows human readable descriptions of attribute settings during the setup of a job.
<i>Author</i> ? New in JDF 1.3	string	Human readable text that identifies the person who created the Comment . See also <i>@PersonalID</i> .
<i>Box</i> ?	rectangle	The rectangle that is associated with the comment. The coordinate system of the rectangle is the same as the coordinate system defined in the <i>@Path</i> attribute.
<i>ID</i> ? New in JDF 1.3	ID	Identification that is used to reference the Comment .

Table 9.14: Comment Element (Sheet 2 of 2)

NAME	DATA TYPE	DESCRIPTION
<i>Language</i> ?	language	Human readable language of the Comment .
<i>Name</i> = "Description" Modified in JDF 1.4	NMTOKEN	A name that defines the usage of a comment. For example, it could determine whether two comments are intended to fill two distinct fields of a user interface. Values include: Description – Human readable description, which is REQUIRED if the Comment element is REQUIRED in a given context, as is the case in the Notification element (see ▶ Table 3.33 Notification Audit Element). DeviceText – Human readable description created by the device that provides details beyond the value of @StatusDetails . New in JDF 1.4 Instruction – Message to the operator that contains information regarding the processing of the job. New in JDF 1.2 JobDescription – Description of the job. A Comment element that contains @Name = "JobDescription" SHALL be specified only in a JDF node or CustomerInfo resource. See also CustomerInfo/@CustomerJobName in ▶ Section 8.32 CustomerInfo. New in JDF 1.2 OperatorText – Message from the operator that contains information regarding the processing of the job. New in JDF 1.2 Orientation – Description of the orientation of a PhysicalResource . TemplateDescription – Description of the job ticket template. A Comment element that contains @Name = "TemplateDescription" SHALL be specified only in the root JDF node. New in JDF 1.2 UserText – Message to a user that contains information regarding the processing of the job. New in JDF 1.2
<i>Path</i> ?	PDFPath	Description of the area that the comment is associated with in the coordinate system of the element where the path resides. In the case of PhysicalResources , Layout resources and resources that are related to Layout , @Path is defined within the coordinate system of the resource in which it resides. For example, if the comment is inserted in an ExposedMedia resource that describes a plate, the path refers to the plate coordinate system. In all other cases, it is defined in the process coordinate system of the JDF node that contains the element that the Comment element containing @Path is defined in. Note: There are cases where a coordinate system is not available and therefore defining @Path is NOT RECOMMENDED (e.g., CustomerInfo).
<i>PersonalID</i> ? New in JDF 1.6	NMTOKEN	Machine readable identifier of the Employee that entered the comment. When the Comment is created by a person with a known Contact/@UserID , then @PersonalID SHOULD contain the value of Contact/@UserID . See also @Author .
<i>TimeStamp</i> ? New in JDF 1.3	dateTime	Describes the date and time when the Comment was created.
	text	Body of the comment. Note: Whitespace is preserved only as generic whitespace in XML. Applications that display comments to the user SHOULD maintain whitespace.

Example 9.4: Multi-line Comment

The following example shows a multi-line comment with whitespace.

```
<Comment AgentName="CIP4 JDF Writer Java" AgentVersion="1.5 BLD 93"
  ID="c_000004" Name="Instruction">Multiline text
  with white space
```

```
and empty lines
</Comment>
```

9.12 ConvertingConfig

New in JDF 1.4

Modified in JDF 1.5

The **ConvertingConfig** element describes a range of sheet sizes that can be used for optimizing a die layout in **DieLayoutProduction** or a press sheet for **SheetOptimizing**.

Modification note: Moved **ConvertingConfig** subelement from ▶ Chapter 8 Resources.

Element Properties

Element referenced by: [DieLayoutProductionParams](#), [SheetOptimizingParams](#)

Table 9.15: ConvertingConfig Element

NAME	DATA TYPE	DESCRIPTION
MarginBottom ?	double	The bottom margin for positioning the layout on the sheet.
MarginLeft ?	double	The left margin for positioning the layout on the sheet.
MarginRight ?	double	The right margin for positioning the layout on the sheet.
MarginTop ?	double	The top margin for positioning the layout on the sheet.
SheetHeight ? Modified in JDF 1.5	DoubleRange	The minimum to maximum sheet height, in points. Modification note: Starting in JDF 1.5, @SheetHeight is optional.
SheetWidth ? Modified in JDF 1.5	DoubleRange	The minimum to maximum sheet width, in points. Modification note: Starting in JDF 1.5, @SheetWidth is optional.
Device *	refelement	The target devices (printing press, die cutter and further finishing equipment) corresponding to this configuration. Typically only the type of Device would be used (e.g., the model of the die cutter). If multiple Devices are specified, then the other attributes in this element SHALL apply to a production configuration that uses all specified Devices .
Media * New in JDF 1.5	refelement	Reference to zero or more Media elements that are candidates for optimization. Note: Media allows a media database savvy consumer to loop over an explicit list of known materials rather than providing results based on a range of dimensions only.

9.13 CostCenter

This element describes an individual area of a company that has separate accounting.

Element Properties

Element referenced by: [Notification](#), [ResourceInfo](#), [JobPhase](#), [Employee](#), [Device](#)

Table 9.16: CostCenter Element

NAME	DATA TYPE	DESCRIPTION
CostCenterID	string	Identification of the cost center
Name ?	string	Name of the cost center.

9.14 Crease

Crease defines an individual crease line on a component.

Element Properties

Element referenced by: [CreasingParams](#),

Table 9.17: Crease Element (Sheet 1 of 2)

NAME	DATA TYPE	DESCRIPTION
Depth ? New in JDF 1.2	double	Depth of the crease, measured in microns [μm].

Table 9.17: Crease Element (Sheet 2 of 2)

NAME	DATA TYPE	DESCRIPTION
<i>RelativeStartPosition</i> ? New in JDF 1.2	XYPair	Relative starting position of the tool. The <i>@RelativeStartPosition</i> is always based on the complete size of the input Component and not on the size of an intermediate state of the folded sheet. The allowed value range is from 0.0 to 1.0 for each component of the XYPair, which specifies the full size of the input Component .
<i>RelativeTravel</i> ? New in JDF 1.2 Deprecated in JDF 1.6	double	Relative distance of the reference edge relative to <i>@From</i> in the coordinates of the incoming Component . The <i>@RelativeTravel</i> is always based on the complete size of the input Component and not on the size of an intermediate state of the folded sheet. The allowed value range is from 0.0 to 1.0, which specifies the full length of the input component.
<i>RelativeWorkingPath</i> ? New in JDF 1.2	XYPair	Relative working path of the tool beginning at <i>@RelativeStartPosition</i> . Since the tools can only work parallel to the edges, one coordinate SHALL be zero. The <i>@RelativeWorkingPath</i> is always based on the complete size of the input Component and not on the size of an intermediate state of the folded sheet. The allowed value range is from 0.0 to 1.0 for each component of the XYPair, which specifies the full size of the input Component .
<i>StartPosition</i> ? Modified in JDF 1.2	XYPair	Starting position of the tool. If both <i>@StartPosition</i> and <i>@RelativeStartPosition</i> are specified, <i>@RelativeStartPosition</i> is ignored. At least one of <i>@StartPosition</i> or <i>@RelativeStartPosition</i> SHALL be specified.
<i>Travel</i> ? New in JDF 1.2 Deprecated in JDF 1.6	double	Distance of the reference edge relative to <i>@From</i> . If both <i>@Travel</i> and <i>@RelativeTravel</i> are specified, <i>@RelativeTravel</i> is ignored. At least one of <i>@Travel</i> or <i>@RelativeTravel</i> SHALL be specified.
<i>WorkingDirection</i> ? Modified in JDF 1.5	enumeration	Direction from which the tool is working. Allowed value is from: ▶ WorkingDirection. Modification note: Starting in JDF 1.5, <i>@WorkingDirection</i> is optional
<i>WorkingPath</i> ?	XYPair	Working path of the tool beginning at <i>@StartPosition</i> . Since the tools can only work parallel to the edges, one coordinate SHALL be zero. If both <i>@WorkingPath</i> and <i>@RelativeWorkingPath</i> are specified, <i>@RelativeWorkingPath</i> is ignored. At least one of <i>@WorkingPath</i> or <i>@RelativeWorkingPath</i> SHALL be specified.

9.15 Cut

Cut describes one straight cut with an arbitrary tool.

Element Properties

Element referenced by: **CuttingParams**,

Table 9.18: Cut Element (Sheet 1 of 2)

NAME	DATA TYPE	DESCRIPTION
<i>CutWidth</i> ? New in JDF 1.4	double	Width in points of u-shaped knife, saw blade, etc.
<i>LowerRibbonName</i> ? New in JDF 1.5	NMTOKEN	<i>@RibbonName</i> of the ribbon on the side of the cut that corresponds to a lower X value of <i>@StartPosition</i> or <i>@RelativeStartPosition</i> .
<i>RelativeStartPosition</i> ? New in JDF 1.2	XYPair	Relative starting position of the tool. The <i>@RelativeStartPosition</i> is always based on the complete size of the input Component and not on the size of an intermediate state of the folded sheet. The allowed value range is from 0.0 to 1.0 for each component of the XYPair, which specifies the full size of the input Component .
<i>RelativeWorkingPath</i> ? New in JDF 1.2	XYPair	Relative working path of the tool beginning at <i>@RelativeStartPosition</i> . Since the tools can only work parallel to the edges, one coordinate SHALL be zero. <i>@RelativeWorkingPath</i> is always based on the complete size of the input Component and not on the size of an intermediate state of the folded sheet. The permissible range of values is from 0.0 to 1.0 for each component of the XYPair, which specifies the full size of the input Component .

Table 9.18: Cut Element (Sheet 2 of 2)

NAME	DATA TYPE	DESCRIPTION
StartPosition ? Modified in JDF 1.2	XYPair	Starting position of the tool. If both @StartPosition and @RelativeStartPosition are specified, @RelativeStartPosition is ignored. At least one of @StartPosition or @RelativeStartPosition SHALL be specified.
UpperRibbonName ? New in JDF 1.5	NMTOKEN	@RibbonName of the ribbon on the side of the cut that corresponds to a higher X value of @StartPosition or @RelativeStartPosition .
WorkingDirection ? Modified in JDF 1.5	enumeration	Direction from which the tool is working. Allowed value is from: ▶ WorkingDirection . Modification note: Starting in JDF 1.5, @WorkingDirection is optional.
WorkingPath ? Modified in JDF 1.2	XYPair	Working path of the tool beginning at @StartPosition . Since the tools can only work parallel to the edges, one coordinate SHALL be zero. If both @WorkingPath and @RelativeWorkingPath are specified, @RelativeWorkingPath is ignored. At least one of @WorkingPath or @RelativeWorkingPath SHALL be specified.

9.16 CutLines

New in JDF 1.5

Element referenced by: [DieLayout](#), [ShapeDef](#)

Table 9.19: CutLines Element

NAME	DATA TYPE	DESCRIPTION
SeparationSpec *	element	Separation name of a die line.

9.17 DeviceMark

New in JDF 1.1

Promoted from subelement status in the [Layout](#) resource with new attributes defined below.

The [DeviceMark](#) element specifies the formatting parameters for how text for a device mark should be marked. This text is provided by an associated [JobField](#) element (see [Layout/MarkObject/JobField](#) or [LayoutElementProductionParams/JobField](#)).

Two methods for text layout are provided by [DeviceMark](#). First, text can be placed within a bounding box defined by a containing [MarkObject](#) (see [MarkObject/@TrimSize](#) for defining the size of that bounding box). When this feature is selected, [DeviceMark/@Font](#), [DeviceMark/@FontSize](#), [DeviceMark/@HorizontalFitPolicy](#) and [DeviceMark/@VerticalFitPolicy](#) MAY be used to specify how text SHALL be fit within that bounding box.

The second method allows the bounding box defined by the text itself to be positioned, rotated, and scaled (along with the text). This facility operates through specifying an anchor point on that bounding box, and having the [MarkObject/@CTM](#) operate relative to that anchor point. [DeviceMark](#) attributes that affect this method are [DeviceMark/@Font](#) and [DeviceMark/@FontSize](#).

See figures below for illustrations of marks generated by [DeviceMark](#).

Element Properties

Element referenced by: [Layout/MarkObject](#), [LayoutPreparationParams](#), [LayoutPreparationParams/PageCell](#)

Table 9.20: DeviceMark Element (Sheet 1 of 2)

NAME	DATA TYPE	DESCRIPTION
Anchor ? New in JDF 1.4	enumeration	Anchor point on or within the bounding box of the text marked by this DeviceMark that MarkObject/@CTM refers to. When @Anchor is specified, MarkObject/@TrimSize , DeviceMark/@HorizontalFitPolicy and DeviceMark/@VerticalFitPolicy are ignored. Note: The bounding box of this DeviceMark is defined by the extent of the text being marked. Allowed value if from: ▶ Anchor .

Table 9.20: DeviceMark Element (Sheet 2 of 2)

NAME	DATA TYPE	DESCRIPTION
<i>Font</i> ? Modified in JDF 1.4	NMTOKEN	The name of the font that SHALL be used for the <i>DeviceMark</i> . Values include: Courier Helvetica Helvetica-Condensed Times-Roman
<i>FontSize</i> ? Modified in JDF 1.4	double	The size of the font that SHALL be used for the <i>DeviceMark</i> , in points ≥ 0 . Modification note: Starting with JDF 1.4 , the data type is no longer integer.
<i>HorizontalFitPolicy</i> ? New in JDF 1.4	enumeration	Allowed values are from: ▶ FitPolicy.
<i>MarkJustification</i> ? Deprecated in JDF 1.4	enumeration	Description of the preferred <i>DeviceMark</i> justification. Interpreted in context of the <i>@MarkOrientation</i> . Allowed values are: Center Left Right Deprecation note: Starting with JDF 1.4 , use <i>DeviceMark/@Anchor</i> to specify the point in the bounding box defined by the text being marked relative to which <i>MarkObject/@CTM</i> is applied to.
<i>MarkOffset</i> ? Deprecated in JDF 1.4	XYPair	Description of the preferred <i>DeviceMark</i> offset. Interpreted in context of the device dependent default position in the coordinate system defined by <i>@MarkOrientation</i> . Deprecation note: Starting with JDF 1.4 , use the <i>MarkObject/@CTM</i> to appropriately place the mark.
<i>MarkOrientation</i> ? Deprecated in JDF 1.4	enumeration	Description of the preferred <i>DeviceMark</i> orientation. Allowed values are: Horizontal Vertical Deprecation note: Starting with JDF 1.4 , use the <i>MarkObject/@CTM</i> to appropriately rotate the mark.
<i>MarkPosition</i> ? Deprecated in JDF 1.4	enumeration	Description of the preferred <i>DeviceMark</i> position. Allowed value is from: ▶ Edge. Deprecation note: Starting with JDF 1.4 , use <i>@Anchor</i> .
<i>VerticalFitPolicy</i> ? New in JDF 1.4	enumeration	Allowed values are from: ▶ FitPolicy.
<i>BarcodeReproParams</i> ? New in JDF 1.4	element	Reproduction parameters for barcodes specified in the parent <i>MarkObject/IdentificationField</i> .

Figure 9-1: Anchor with no scaling and rotation of 90° clockwise

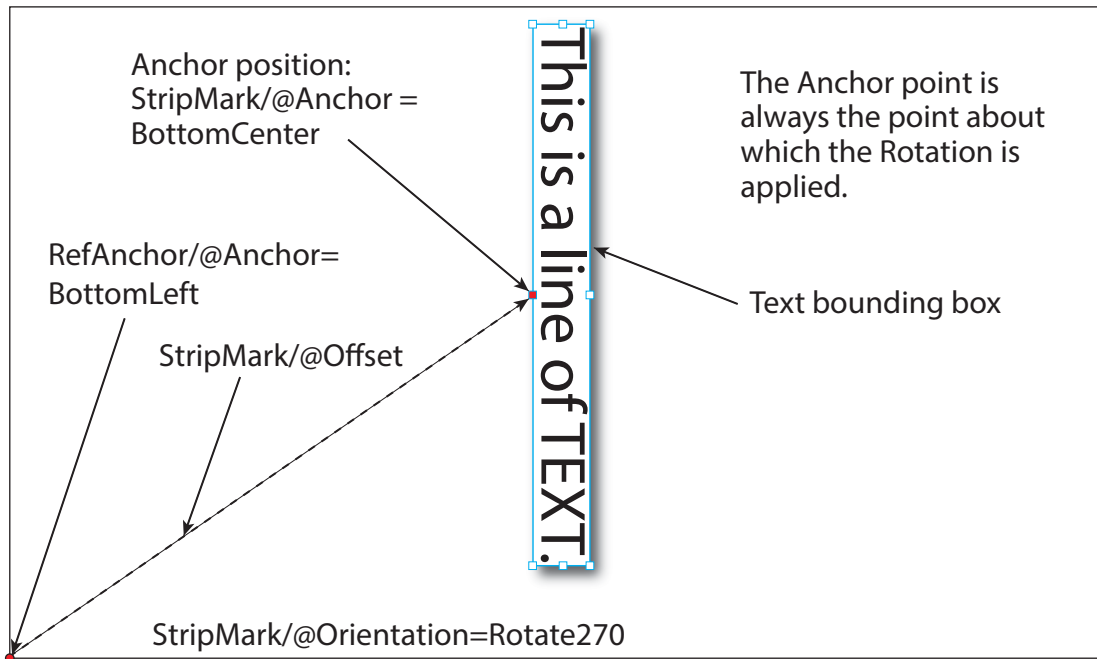

9.18 DeviceNSpace

The **DeviceNSpace** can be used in several ways. For example, defining the specific colorants of a **DeviceNSpace**:

- **ColorantControl/ColorPool/@ColorantSetName** matches **ColorantControl/DeviceNSpace/@Name**, and a:
- **ColorantControl/ColorPool/Color** resource (with correct **@Name** of colorant and other defining attributes) exists for each colorant of the **DeviceNSpace** as given in:
- **ColorantControl/DeviceNSpace/SeparationSpec/@Name**

For example, defining a single colorant in terms of its values in a **DeviceNSpace**:

- **ColorantControl/ColorantParams** names a colorant (e.g., a Pantone spot color).
- **ColorantControl/DeviceNSpace** names a DeviceN color space, which then the
 - **ColorantControl/ColorPool/@ColorantSetName** matches, and then the corresponding
 - **ColorantControl/ColorPool/Color/DeviceNSpace/@ColorList** attribute gives the set of **DeviceNSpace** colorant percent values necessary to construct the,
 - **ColorantControl/@ColorantParams** colorant (also named **ColorantControl/ColorPool/Color/@Name**) in using **DeviceNSpace** colorants.

Element Properties

Element referenced by: **ColorantControl, ColorSpaceConversionOp**

Table 9.21: DeviceNSpace Element

NAME	DATA TYPE	DESCRIPTION
<i>N</i>	integer	The number of colors that define the color space.
<i>Name</i> ?	string	Color space name (e.g., HexaChrome or HiFi).
SeparationSpec *Modified in JDF 1.2	element	Ordered list of colorant names that define the DeviceN color space. Note: These colorants SHALL be specified in a corresponding ColorantParams element of the ColorantControl or be implied by @ProcessColorModel . In other words, they SHALL be real, physical colorants.

9.19 Disjointing

The **Disjointing** element describes how individual components are separated from one another on a stack or in an output bin or stacker. **Disjointing** SHALL apply only to the current job and SHALL NOT apply to jobs that follow.

Note: A less granular disjointing implies more granular disjointing, e.g. a set break implies a document break and a sheet break.

Element Properties

Element referenced by [Component](#), [StackingParams](#)

Table 9.22: Disjoining Element

NAME	DATA TYPE	DESCRIPTION
Number ?	integer	Number of sheets that make up one component. The @OffsetUnits attribute specifies the type of the component. See @OffsetUnits for more details.
Offset ?	XYPair	Offset dimension in X and Y dimensions that separates the components.
OffsetAmount ?	integer	The number of components that SHALL be shifted in @OffsetDirection simultaneously. @OffsetUnits SHALL specify the type of the component counted by this attribute. Any less granular component break than the value of @OffsetUnits SHALL cause a shift regardless of the value of @OffsetAmount , e.g. a set break would cause a shift, even if the current number of documents were less than @OffsetAmount in case @OffsetUnits ="Docs" or @OffsetUnits ="DocCopies".
OffsetDirection ?	enumeration	Offset-shift action for the first component. A component can be offset to one of two positions—left or right. Allowed values are: Alternate – The position of the first component of a new job is opposite the position of the previous component, and subsequent components are each offset to alternating positions. For example, if the last item in the stack was positioned to the right, then the subsequent items will be positioned to the left, right, left, right and so on. Left – The first component of a new job is on the left, and subsequent components are each offset to alternating positions. None – Do not offset consecutive components. The position of all components is the same as the position of the previous component. Right – The first component of a new job is on the right, and subsequent components are each offset to alternating positions. Straight – Same as "None". Deprecated in JDF 1.2
OffsetUnits ? New in JDF 1.5	NMTOKEN	This attribute specifies the type of the component counted by the @OffsetAmount attribute. If @Number is present, it specifies the number of sheets that make up a component (e.g., if @OffsetUnits is "Sets", the value of @Number specifies the number of sheets in a set, and @OffsetAmount specifies the number of sets). If @Number is not specified, it is assumed that the system has an internal way to keep track of component boundaries, whatever they may be (e.g., set or document boundaries). In a simple, non-VDP workflow, the product of @Number and @OffsetAmount is the number of sheets between shifts or separators. Values include: DocCopies – Every individual document is counted. Docs – All copies of identical documents are counted as one. Jobs – The entire job SHALL be counted. For this case @OffsetAmount SHALL have a value of 1, i.e. when @Units ="Jobs", @OffsetAmount ="1". SetCopies – Every individual Set is counted. Sets – All copies of identical sets are counted as one. Sheets – Each sheet is counted. Stacks – Each stack is counted. Deprecated in JDF 1.6.
Overfold ? Deprecated in JDF 1.1	double	Expansion of the overfold of a sheet. This attribute is needed for the Inserting or other postpress processes. Moved to Component .
IdentificationField * Modified in JDF 1.1	element	Marks that identify the range of sheets to be used in a process. A scanner will scan the sheets and detect a component boundary by scanning a mark (e.g., a bar code) that matches the description in the IdentificationField element.
InsertSheet ?	refelement	Some kind of physical marker (e.g., a paper strip or a yellow paper sheet) that separates the components.

9.20 Disposition

New in JDF 1.2

SUBLELEMENTS

This element describes how long an asset SHOULD be maintained by a device. The device will perform an action defined by [Disposition](#)/[@DispositionAction](#) when a “disposition time” occurs. Disposition time is defined as either:

- $@Until \leq \text{"Disposition time"} \leq @Until + @ExtraDuration$
- $\text{"ProcessCompleteTime"} + @MinDuration \leq \text{"Disposition time"} \leq \text{"ProcessCompleteTime"} + @MinDuration + @ExtraDuration$

Element Properties

Element referenced by: [ResourcePullParams](#), [QueueSubmissionParams](#), [SubmitQueueEntry/QueueSubmissionParams](#), [FileSpec](#), [RunList](#)

Table 9.23: Disposition Element

NAME	DATA TYPE	DESCRIPTION
DispositionAction = "Delete"	enumeration	Allowed values are: Delete – The asset is deleted when disposition time occurs. Archive – The asset is archived when disposition time occurs.
DispositionUsage ?	enumeration	Specifies the usage of the asset by the process. Default behavior: Disposition applies to all processes that link to the Disposition resource (if @DispositionUsage not specified). Allowed values is from: ▶ Usage
ExtraDuration ?	duration	Indicates the maximum duration that the device is allowed to retain the asset after the time specified by @MinDuration or @Until . If @ExtraDuration , @MinDuration and @Until are all unspecified, the asset is retained for a system specified time.
MinDuration ?	duration	Indicates the minimum duration that the device SHOULD retain the asset after the process that uses the asset completes.
Priority = "0"	integer	Value between 0 and 100 that specifies the order in which assets are deleted or archived when the values of @ExtraDuration , @MinDuration and @Until cannot be honored (e.g., when local storage runs low). Assets with @Priority = "0" will be deleted first.
Until ?	dateTime	Indicates an absolute point in time when the device or application SHOULD stop the asset retention. If @Until is specified, @MinDuration SHALL be ignored.

9.21 FitPolicy

New in JDF 1.1

This element specifies how to fit content into a receiving container (e.g., a page onto a [ContentObject](#) of an imposed sheet). See the description of each reference to [FitPolicy](#) to determine what the context-specific content is and what the receiving containers are.

Element Properties

Element referenced by: [ImageSetterParams](#), [InterpretingParams](#), [Layout/PlacedObject](#), [LayoutPreparationParams](#), [LayoutPreparationParams/PageCell](#), [RasterReadingParams](#)

Table 9.24: FitPolicy Element (Sheet 1 of 2)

NAME	DATA TYPE	DESCRIPTION
ClipOffset ?	XYPair	Defines the offset (position) of the imaged area in the non-rotated source image when @SizePolicy is "ClipToMaxPage". The values "0.0 0.0" mean that the imaged area starts at the lower left point of the receiving container. If absent, the imaged area SHALL be taken from the center of the source image. If FitPolicy is defined in the context of a PageCell , @ClipOffset is ignored when PageCell/@ImageShift is specified.
GutterPolicy = "Fixed"	enumeration	Allows printing of NUp grids even if the media size does not match the requirements of the data. @GutterPolicy SHALL NOT be specified when FitPolicy is referenced from a Layout resource. Allowed values are: Distribute – The gutters can grow or shrink to the value specified in @MinGutter . Fixed – The gutters are fixed.

Table 9.24: FitPolicy Element (Sheet 2 of 2)

NAME	DATA TYPE	DESCRIPTION
<i>MinGutter</i> ?	XYPair	Minimum width in points of the horizontal and vertical gutters formed between rows and columns of pages of a multi-up sheet layout. The first value specifies the minimum width of all horizontal gutters and the second value specifies the minimum width of all vertical gutters. <i>@MinGutter</i> SHALL NOT be specified when <i>FitPolicy</i> is referenced from a <i>Layout</i> resource.
<i>RotatePolicy</i> ?	enumeration	Specifies the policy for the device to automatically rotate the content to optimize the fit of the content to the receiving container. Allowed values are: <i>NoRotate</i> – Do not rotate. <i>RotateClockwise</i> – Rotate clockwise by 90°. <i>RotateCounterClockwise</i> – Rotate counterclockwise by 90°. <i>RotateOrthogonal</i> – Rotate by 90° in either direction.
<i>SizePolicy</i> ? Modified in JDF 1.1A	enumeration	Allows printing even if the container size does not match the requirements of the data. Allowed values are: <i>Abort</i> – Emit an error and abort printing. <i>ClipToMaxPage</i> – The page contents SHALL be clipped to the size of the container. The printed area is either centered in the source image if no <i>@ClipOffset</i> key is given, or from that position that is determined by <i>@ClipOffset</i> . <i>FitToPage</i> – The page contents SHALL be scaled up or down to fit the container. The aspect ratio SHALL be maintained. <i>ReduceToFit</i> – The page contents SHALL be scaled down but not scaled up to fit the container. The aspect ratio SHALL be maintained. <i>Tile</i> – The page contents SHALL be split into several tiles, each tile SHALL be printed on its own surface.

9.22 Fold

New in JDF 1.1

Fold describes an individual folding operation of the *Component*.

Element Properties

Element referenced by: *FoldingIntent*, *BinderySignature*, *FoldingParams*

Table 9.25: Fold Element

NAME	DATA TYPE	DESCRIPTION
<i>From</i>	enumeration	Edge from which the page SHALL be folded. Allowed values are: <i>Front</i> <i>Left</i>
<i>RelativeTravel</i> ? New in JDF 1.2	double	Relative distance of the reference edge relative to <i>@From</i> in the coordinates of the incoming <i>Component</i> . The <i>@RelativeTravel</i> is always based on the complete size of the input <i>Component</i> and not on the size of an intermediate state of the folded sheet. The allowed value range is from 0.0 to 1.0, which specifies the full length of the input <i>Component</i> . At least one of <i>@Travel</i> or <i>@RelativeTravel</i> SHALL be specified.
<i>To</i>	enumeration	Direction in which the page SHALL be folded. Allowed values are: <i>Up</i> – Upwards; corresponds to a valley fold with the left/bottom side coming over the opposite side. <i>Down</i> – Downwards; corresponds to a mountain or peak fold with the left/bottom side coming under the opposite side.
<i>Travel</i> ? Modified in JDF 1.2	double	Distance of the reference edge relative to <i>@From</i> . If both <i>@Travel</i> and <i>@RelativeTravel</i> are specified, <i>@RelativeTravel</i> is ignored. At least one of <i>@Travel</i> or <i>@RelativeTravel</i> SHALL be specified.

9.23 GangSource

New in JDF 1.6

GangSource provides source job information about a **BinderySignature** that is placed on a gang form.

Element Properties

Element referenced by: **JobPhase**, **QueueFilter**, **QueueEntry**, **NodeInfo**

Table 9.26: **GangSource** Element

NAME	DATA TYPE	DESCRIPTION
<i>AssemblyID</i> ?	NMTOKEN	If present, @ <i>AssemblyID</i> SHALL reference the BinderySignature that this GangSource represents.
<i>Copies</i>	integer	@ <i>Copies</i> SHALL specify the number of copies of the BinderySignature that are required.
<i>JobID</i>	string	@ <i>JobID</i> SHALL reference JDF / <i>@JobID</i> of the individual job that describes the processing prior to and after printing and cutting the gang sheet.

9.24 GeneralID

New in JDF 1.3

Modified in JDF 1.4

Modification note: Starting with **JDF** 1.4, **GeneralID** becomes an element, and is no longer a resource. **GeneralID** becomes a child of any element. See ▶ Table 3.1 Any Element (generic content).

GeneralID describes a generic variable. The name or usage of the variable is specified in **GeneralID**/*@IDUsage* and the specific value of the variable is specified in **GeneralID**/*@IDValue*. The data type is specified in **GeneralID**/*@DataType*.

Element Properties

Element referenced by: **ContentList/ContentMetadata**

Table 9.27: **GeneralID** Element

NAME	DATA TYPE	DESCRIPTION
<i>DataType</i> ? New in JDF 1.4 Modified in JDF 1.5	enumeration	Data type of the variable. Allowed value is from: ▶ <i>DataType</i> .

Table 9.27: GeneralID Element

NAME	DATA TYPE	DESCRIPTION
<i>IDUsage</i> Modified in JDF 1.4	NMTOKEN	Usage of the GeneralID . There are no predefined values in JDF . Values below with "AdsML" prefix are defined in ▶ [AdsML]. Values include: DeviceProductID – An ID of the resource as defined in the device namespace. For instance, media catalogs of a press may provide media identifiers that are different from those defined by the MIS (which are identified with @ProductID values). New in JDF 1.4 AdsML:AdBuyer_BookingTransactionID – an ID for the booking transaction that was assigned by a party acting on behalf of the advertiser AdsML:AdSeller_BookingTransactionID – an ID for the booking transaction that was assigned by the publisher or a party acting on its behalf AdsML:AdBuyer_AdMaterialID – an ID for the artwork that was assigned by a party acting on behalf of the advertiser AdsML:AdSeller_AdMaterialID – an ID for the artwork that was assigned by the publisher or a party acting on its behalf. LineID – an ID for PrintTalk which associates a PrintTalk//Pricing/Price[@LineID="someValue"] element with a JDF element embedded in PrintTalk , such as PrintTalk//jdf:DeliveryParams/Drop/DropItem[GeneralID/@IDUsage="LineID" and GeneralID/@IDValue="someValue"] . ShopID – Identifier of a web shop if the job has been submitted in a web to print environment. If the JDF was submitted via PrintTalk, @IDValue SHOULD be a copy of PrintTalk/Header/From/Credential[@domain="jdf:ShopID"]/Identity . L – named variable that defines length within a ShapeTemplate . (See ▶ Table 8.251 ShapeTemplate Element.) W – named variable that defines width within a ShapeTemplate . (See ▶ Table 8.251 ShapeTemplate Element.) D – named variable that defines depth within a ShapeTemplate . (See ▶ Table 8.251 ShapeTemplate Element.)
<i>IDValue</i>	string	Value of the GeneralID . The data type of the value SHALL correspond to GeneralID/@DataType .

9.25 GlueLine

This element provides the information for determining where and how to apply glue.

Element Properties

Element referenced by: [InsertingIntent](#), [Insert](#), [BoxFoldingParams](#), [BoxFoldingParams/BoxFoldAction](#), [CaseMakingParams](#), [EndSheetGluingParams/EndSheet](#), [GlueApplication](#), [GluingParams/Glue](#), [HeadBandApplicationParams](#), [InsertingParams](#), [ThreadSewingParams](#), [MediaLayers](#)

Table 9.28: GlueLine Element (Sheet 1 of 2)

NAME	DATA TYPE	DESCRIPTION
<i>AreaGlue = "false"</i> New in JDF 1.1	boolean	Specifies that this GlueLine SHOULD cover the complete width of the Component it is applied to.
<i>GlueBrand ?</i>	string	Glue brand.
<i>GlueLineWidth ?</i>	double	Width of the glue line. Note: In extreme cases, the glue line could cover the entire width of the input component.
<i>GlueType ?</i>	enumeration	Glue type. Allowed values are: ColdGlue – Any type of glue that needs no heat treatment. Hotmelt – Hotmelt EVA (Ethylene-vinyl acetate). PUR – Polyurethane.

Table 9.28: GlueLine Element (Sheet 2 of 2)

NAME	DATA TYPE	DESCRIPTION
<i>GluingPattern</i> ? Modified in JDF 1.3	NumberList	Glue line pattern defined by the length of a glue line segment (1st element, 3rd and all odd elements of the list of values) and glue line gap (2nd element, 4th and all even elements of the list of values). A solid line SHALL be expressed by the pattern (1 0). <i>@GluingPattern</i> SHALL contain an even number of entries. If the total length of <i>@GluingPattern</i> is less than <i>@WorkingPath</i> or the length implied by <i>@RelativeWorkingPath</i> , the pattern restarts after the last gap. If the total length of <i>@GluingPattern</i> is larger than <i>@WorkingPath</i> or the length implied by <i>@RelativeWorkingPath</i> , the pattern SHALL be clipped at the end.
<i>MeltingTemperature</i> ?	integer	Temperature needed for melting the glue, in degrees centigrade. <i>@MeltingTemperature</i> SHALL NOT be specified unless <i>@GlueType</i> ="Hotmelt" or <i>@GlueType</i> ="PUR".
<i>RelativeStartPosition</i> ? New in JDF 1.2	XYPair	Relative starting position of the tool. The <i>@RelativeStartPosition</i> is always based on the complete size of the input Component and not on the size of an intermediate state of the folded sheet. The allowed value range is from 0.0 to 1.0 for each component of the XYPair, which specifies the full size of the input Component .
<i>RelativeWorkingPath</i> ? New in JDF 1.2	XYPair	Relative working path of the tool beginning at <i>@RelativeStartPosition</i> . The <i>@RelativeWorkingPath</i> is always based on the complete size of the input Component and not on the size of an intermediate state of the folded sheet. The allowed value range is from 0.0 to 1.0 for each component of the XYPair, which specifies the full size of the input Component .
<i>StartPosition</i> ? Modified in JDF 1.2	XYPair	Start position of the glue line. The start position is given in the coordinate system of the mother sheet. If both <i>@StartPosition</i> and <i>@RelativeStartPosition</i> are specified, <i>@RelativeStartPosition</i> is ignored.
<i>WorkingPath</i> ? Modified in JDF 1.2	XYPair	Relative working path of the gluing tool. If both <i>@WorkingPath</i> and <i>@RelativeWorkingPath</i> are specified, <i>@RelativeWorkingPath</i> is ignored.

9.26 Hole

The **Hole** element describes an individual hole.

Element Properties

Element referenced by: [HoleLine](#), [HoleList](#), [HoleMakingIntent](#), [HoleMakingParams](#)

Table 9.29: Hole Element

NAME	DATA TYPE	DESCRIPTION
<i>Center</i>	XYPair	Position of the center of the first hole relative to the Component coordinate system. For more information, see ▶ Section 6.5.23 HoleMaking.
<i>Extent</i>	XYPair	Size (bounding box) of the hole, in points. If <i>@Shape</i> is "Round", only the first entry of <i>@Extent</i> SHALL be evaluated and SHALL define the hole diameter.
<i>Reinforcement</i> ? New in JDF 1.6	NMTOKEN	<i>@Reinforcement</i> specifies how a hole SHALL be reinforced. Values include: Grommet Note: Additional details of the reinforcement MAY be supplied in a MiscConsumable with MiscConsumable / <i>@ConsumableType</i> ="Grommet".
<i>Shape</i> Modified in JDF 1.1	enumeration	Shape of the hole. Allowed values are: Elliptic Rectangular Round

9.27 HoleLine

New in JDF 1.1

Line hole punching generates a series of holes with identical distance (pitch) running parallel to the edge of a web, which is mainly used to transport paper through continuous-feed printers and finishing devices (form processing). The final product typically is a web with two lines of holes, one at each edge of the web. The parameters for one line of holes are specified in the [HoleLine](#) resource. The distance between holes within each line of holes is identical (constant pitch).

Element Properties

Element referenced by: [HoleList](#), [HoleMakingParams](#)

Table 9.30: HoleLine Element

NAME	DATA TYPE	DESCRIPTION
Pitch	double	Center-hole to center-hole distance within a line of holes.
Hole	element	Size and position of the first hole in the HoleLine .

9.28 InsertSheet

[InsertSheet](#) resources define device generated images and sheets which can be produced along with the job. [InsertSheet](#) elements include separators sheets, error sheets, accounting sheets and job sheets. The information provided on the sheet depends on the type of sheet. In some cases, an [Imposition](#) process can encounter [RunList](#) elements that do not provide enough finished pages to complete a [Layout](#) resource or its children. [InsertSheet](#) resources are used to provide a standard way of completing such [Layout](#) resources. [InsertSheet](#) resources MAY also be used to start new sheet resources (e.g., to ensure that a new chapter starts on a right-hand page). In addition, [InsertSheet](#) MAY specify whether new media are to be inserted after the current sheet, signature, instance document or job is completed.

[InsertSheet](#) elements MAY be used at the beginning or end of [RunList](#) with a [@SheetUsage](#) attribute of "Header" or "Trailer". When an [InsertSheet](#) appears both in a [RunList](#) and in a [Layout](#), the following precedence applies:

- 1 The [InsertSheet](#) with [@Usage](#) "FillSurface" from the [RunList](#) is applied first.
- 2 The [InsertSheet](#) with [@Usage](#) "FillSheet" from the [RunList](#) is applied.
- 3 The [InsertSheet](#) with [@Usage](#) "FillSignature" from the [RunList](#) is applied.
- 4 After completely processing the [RunList](#) [InsertSheet](#) elements once, apply the [Layout](#) partition's [InsertSheet](#) elements.

If the [RunList](#) of the [InsertSheet](#) does not supply enough content to fill a sheet, signature or surface, the [RunList](#) will be reapplied until no [PlacedObject](#) slots remain to be filled. When an [InsertSheet](#) is used in a [RunList](#) of a process that does not use a [Layout](#) or [LayoutPreparationParams](#) resource (i.e., that process is not a part of a combined process with [Imposition](#) or [LayoutPreparation](#)), only [@Usage](#) "Header" or "Trailer" are valid.

Element Properties

Element referenced by: [Layout](#), [RunList](#)

Table 9.31: InsertSheet Element (Sheet 1 of 2)

NAME	DATA TYPE	DESCRIPTION
IncludeInBundleItem ? New in JDF 1.2	enumeration	Defines bundle items when this InsertSheet is not a subelement of RunList . If this InsertSheet is a subelement of a RunList , then @IncludeInBundleItem SHALL be ignored, and RunList/@EndOfBundleItem SHALL be used instead. As an example, @IncludeInBundleItem controls whether the InsertSheet SHALL be included in a bundle item for purposes of finishing the InsertSheet with other sheets. Allowed values are: After – This InsertSheet SHALL be included in the BundleItem that occurs after this InsertSheet . "After" is equivalent to "None" if no BundleItem is defined after this InsertSheet Before – This InsertSheet SHALL be included in the BundleItem that occurs before this InsertSheet . "Before" is equivalent to "None" if no BundleItem is defined before this InsertSheet . None – This InsertSheet is not included in a BundleItem . New – A new BundleItem is created. This InsertSheet will be in the new BundleItem by itself unless another InsertSheet with @IncludeInBundleItem = "Before" occurs immediately after this InsertSheet .
IsWaste ?	boolean	Specifies whether the InsertSheet is waste that SHALL be removed from the document before further processing. If "true", the InsertSheet SHALL be discarded when finishing the document.

Table 9.31: InsertSheet Element (Sheet 2 of 2)

NAME	DATA TYPE	DESCRIPTION
<p>MarkList ? New in JDF 1.1</p>	<p>NMTOKENS</p>	<p>List of marks that are to be marked on this InsertSheet. Ignored if a sheet is specified in this InsertSheet.</p> <p>Values include:</p> <ul style="list-style-type: none"> CIELABMeasuringField ColorControlStrip ColorRegisterMark CutMark DensityMeasuringField IdentificationField JobField PaperPathRegisterMark RegisterMark ScavengerArea
<p>SheetFormat ? New in JDF 1.1 Modified in JDF 1.2</p>	<p>NMTOKEN</p>	<p>Identifies that device dependent information SHALL be included on the InsertSheet.</p> <p>Values include:</p> <ul style="list-style-type: none"> Blank Brief Duplicate – Valid for <code>@SheetUsage = "Interleaved"</code> or <code>"InterleavedBefore"</code>. Specifies that the interleaved sheet SHALL contain the same (duplicate) content as the previous (<code>"Interleaved"</code>) or following (<code>"InterleavedBefore"</code>) sheet. If there is content on both sides of the previous or following sheet (duplex), then the InsertSheet has both sides duplicated. New in JDF 1.2 Full Standard
<p>SheetType New in JDF 1.1</p>	<p>enumeration</p>	<p>Identifies the type of sheet.</p> <p>Allowed values are:</p> <ul style="list-style-type: none"> AccountingSheet – A sheet that reports accounting information for the job. ErrorSheet – A sheet that reports errors for the job. FillSheet – A sheet that fills ContentObject elements with no matching entry in the content RunList. InsertSheet – A sheet that is inserted to the job (e.g., a preprinted cover). JobSheet – A sheet that delimits the job. SeparatorSheet – A sheet that delimits pages, sections, copies or instance documents of the job.
<p>SheetUsage New in JDF 1.1 Modified in JDF 1.2</p>	<p>enumeration</p>	<p>Indicates where this InsertSheet SHALL be produced and inserted into the set of output pages.</p> <p>Allowed values are from: ▶ Table 9.32 SheetUsage Attribute Values.</p>
<p>Usage ? Deprecated in JDF 1.1</p>	<p>enumeration</p>	<p>Allowed values are from: ▶ Table 9.32 SheetUsage Attribute Values.</p> <p>Deprecation note: Starting with JDF 1.1, use <code>@SheetUsage</code>.</p>
<p>Layout ? New in JDF 1.3</p>	<p>refelement</p>	<p>Details of the sheet that will be inserted. Contents for this Layout are drawn from the RunList included in this InsertSheet if any. If not specified, the system specified insert sheets are used. Any InsertSheet resources referenced by this Layout are ignored.</p>
<p>RunList ?</p>	<p>refelement</p>	<p>A RunList that provides the content for the InsertSheet. Any InsertSheet resources referenced by this RunList are ignored.</p>
<p>Sheet ? Deprecated in JDF 1.3</p>	<p>refelement</p>	<p>Details of the Sheet that will be inserted. Contents for this Sheet are drawn from the RunList included in this InsertSheet if any. If not specified, the system specified insert sheets are used. Any InsertSheet resources referenced by this Sheet are ignored.</p> <p>Deprecation note: Starting with JDF 1.3, use Layout.</p>

Table 9.32: SheetUsage Attribute Values

VALUE	DESCRIPTION
FillForceBack	Valid for @SheetType = "FillSheet". Contents of the RunList of the InsertSheet are used to fill the next finished front page of the current sheet before forcing the next page of the content RunList to the next finished back page if not already on a finished back page. Modification note: Starting with JDF 1.4, this value applies to finished pages rather than sheet surfaces.
FillForceFront	Valid for @SheetType = "FillSheet". Contents of the RunList of the InsertSheet are used to fill the next finished back page of the current sheet before forcing the next page of the content RunList to the next finished front page if not already on a finished front page. A typical use is to start a chapter on the front side of the finished page. Modification note: Starting with JDF 1.4, this value applies to finished pages rather than sheet surfaces.
FillSheet	Valid for @SheetType = "FillSheet". Contents from the RunList of the InsertSheet are used to fill the current sheet.
FillSignature	Valid for @SheetType = "FillSheet". Contents from the RunList of the InsertSheet are used to fill the current signature.
FillSurface	Valid for @SheetType = "FillSheet". Contents from the RunList of the InsertSheet are used to fill the current surface.
Header	Valid for @SheetType = "InsertSheet", "JobSheet" or "SeparatorSheet". The sheet is produced at the beginning of the job (for JobSheet), or at the beginning of each copy of each instance document (for SeparatorSheet), or is appended before the current sheet, signature, layout or RunList as defined by its context. Contents for the sheet are drawn from the RunList included in this InsertSheet resource if one is included. If a RunList is not included, the inserted sheet is filled with system-specified content defined by @SheetType.
Interleaved	Valid for @SheetType = "SeparatorSheet". The sheet is produced after each page (e.g., used to insert sheets under transparencies). Contents for the sheet are drawn from the RunList included in this InsertSheet resource if one is included. If a RunList is not included, the inserted sheet is filled with system-specified content defined by @SheetType = "SeparatorSheet".
InterleavedBefore New in JDF 1.2	Valid for @SheetType = "SeparatorSheet". The sheet is produced before each page (e.g., used to insert sheets before transparencies). Contents for the sheet are drawn from the RunList included in this InsertSheet resource if one is included. If a RunList is not included, the inserted sheet is filled with system-specified content defined by @SheetType = "SeparatorSheet".
OnError	Valid for @SheetType = "ErrorSheet". The sheet is produced at the end of the job only when an error or warning occurs.
Slip	Valid for @SheetType = "SeparatorSheet". The sheet is produced between each copy of each instance document. Contents for the sheet are drawn from the RunList included in this InsertSheet resource if one is included. If a RunList is not included, the inserted sheet is filled with system-specified content defined by @SheetType = "SeparatorSheet".
SlipCopy	Valid for @SheetType = "SeparatorSheet". The sheet is produced between each copy of the job, which is defined to be when the complete RunList has been consumed. Contents for the sheet are drawn from the RunList included in this InsertSheet resource if one is included. If a RunList is not included, the inserted sheet is filled with system-specified content defined by @SheetType = "SeparatorSheet".
Trailer	Valid for @SheetType = "AccountingSheet", "ErrorSheet", "InsertSheet", "JobSheet" and "SeparatorSheet". The sheet is produced at the end of the job (for "AccountingSheet", "ErrorSheet" and "JobSheet"), or at the end of each copy of each instance document (for "SeparatorSheet"), or is appended after the current sheet, signature, layout or RunList as defined by its context. Contents for the sheet are drawn from the RunList included in this InsertSheet resource if one is included. If a RunList is not included, the inserted sheet is filled with system specified content defined by SheetType. Note: Use @SheetType = "ErrorSheet" and @SheetUsage = "Trailer" to always produce a sheet that contains error or success information even if no errors or warnings occurred.

9.29 JobField

New in JDF 1.1

A **JobField** is a mark object that specifies the details of a job. The **JobField** elements are also referred to as slug lines.

Element Properties

Element referenced by: [Layout/MarkObject](#), [LayoutPreparationParams](#), [StripMark](#)

Table 9.33: JobField Element

NAME	DATA TYPE	DESCRIPTION
JobFormat ? New in JDF 1.4	string	A formatting string used with @JobTemplate to generate a string. Allowed values are from: ▶ Appendix H String Generation.
JobTemplate ? New in JDF 1.4	string	A list of values used with @JobFormat to generate a string. Allowed values are from: ▶ Appendix H String Generation.
OperatorText ?	string	Text from the operator. Note: This was erroneously described as text to the operator in JDF 1.1 and below. Constraint: Starting with JDF 1.4 , if @JobFormat and @JobTemplate are specified, @ShowList , @OperatorText and @UserText SHALL NOT be specified.
ShowList ? Modified in JDF 1.4	NMTOKENS	List of elements to display in the JobField . Constraint: Starting with JDF 1.4 , if @JobFormat and @JobTemplate are specified, @ShowList , @OperatorText and @UserText SHALL NOT be specified. Values include those from: ▶ Table H.1 Predefined variables used in @XXXXTemplate . New in JDF 1.4 Modification note: Starting with JDF 1.4 , the values come from a common list rather than a list that is custom to this element. In addition, @ShowList becomes optional.
UserText ?	string	User-defined text to output with JobField . Constraint: Starting with JDF 1.4 , if @JobFormat and @JobTemplate are specified, @ShowList , @OperatorText and @UserText SHALL NOT be specified.
DeviceMark ? Modified in JDF 1.3 Deprecated in JDF 1.4	element	DeviceMark defines the formatting parameters for the mark. If not specified, the settings defined in LayoutPreparationParams/DeviceMark are assumed. Deprecation note: Starting with JDF 1.4 , DeviceMark SHALL be specified in the parent MarkObject element.

9.30 MarkColor

New in JDF 1.5

Definition of the separations used to fill a dynamic mark.

Element Properties

Element referenced by: [FillMark](#), [StripMark](#)

Table 9.34: MarkColor Element

NAME	DATA TYPE	DESCRIPTION
Name	string	Name of the separation
Tint	double	Value from 0 (not used) to 1 (100% tint) of the separation specified in @Name .

9.31 MediaLayers

MediaLayers contains an ordered list of subelements. Each subelement describes an individual layer of a layered **Media** resource. The first layer in **MediaLayers** is the front layer of the **Media** until the last layer, which defines the back.

Element Properties

Element referenced by: [MediaIntent](#), [Media](#)

Table 9.35: MediaLayers Element

NAME	DATA TYPE	DESCRIPTION
GlueLine *	element	GlueLine resource describing a glue layer of a layered Media resource. Each GlueLine resource SHALL have GlueLine /@AreaGlue = "true".
Media *	refelement	Media resources describing a layer of a layered Media resource.

9.32 MetadataMap

New in JDF 1.4

[MetadataMap](#) allows metadata embedded in PDL files to be assigned to partition key values, certain [RunList](#) attributes, or attributes created using [GeneralID](#). During the mapping of PDL data to the **JDF** document structure (see the definition in the glossary or the discussion in the [Imposition](#) process), each [MetadataMap](#) element SHALL be evaluated for each node (set, document, page, etc.) of the PDL document structure. For XML based PDL files an XPath expression SHALL be evaluated relative to the XML node that defines each node in the document hierarchy. For non-XML based PDLs a PDL specific mapping of the XPath to the PDL document structure SHALL be used instead and the value assignment is performed on the derived XML for the PDL file. If the path specified by the XPath does not exist in the PDL, then the associated metadata value is undefined, otherwise the metadata value will be set to the conversion of the node list to a string.

When [MetadataMap](#) is specified in the context of an [IdentificationField](#), data can be extracted from the barcode represented by the [IdentificationField](#).

Element Properties

Element referenced by: [IdentificationField](#), [RunList](#)

Table 9.36: MetadataMap Element (Sheet 1 of 2)

NAME	DATA TYPE	DESCRIPTION
Context = "PagePool"	enumeration	Specifies the node context in which the XPaths specified in this MetadataMap element are to be evaluated. Allowed values are: Set – evaluated relative to the current set node. Document – evaluated relative to the current document node. SubDoc0 – evaluated relative to the current subdocument immediately below the document level. SubDoc1 – evaluated relative to the current subdocument immediately below "SubDoc0" level. SubDoc2 – see "SubDoc1", but relative to "SubDoc1" level. SubDoc3 – see "SubDoc1", but relative to "SubDoc2" level. SubDoc4 – see "SubDoc1", but relative to "SubDoc3" level. SubDoc5 – see "SubDoc1", but relative to "SubDoc4" level. SubDoc6 – see "SubDoc1", but relative to "SubDoc5" level. SubDoc7 – see "SubDoc1", but relative to "SubDoc6" level. SubDoc8 – see "SubDoc1", but relative to "SubDoc7" level. SubDoc9 – see "SubDoc1", but relative to "SubDoc8" level. PagePool – evaluated relative to the current Page Pool. Page – evaluated relative to the current page. Object – evaluated for each unique object on each page.
DataType	enumeration	Expected data type of the metadata value. Allowed values are from: ▶ DataType . Allowed values also include: PartIDKeys – Then @Name SHALL match a partition key.

Table 9.36: MetadataMap Element (Sheet 2 of 2)

NAME	DATA TYPE	DESCRIPTION
Name	NMTOKEN	<p>The name of the metadata.</p> <p>If <code>@DataType = "PartIDKeys"</code>, the value of <code>@Name</code> SHALL be a <code>@PartIDKeys</code> value. See <code>@PartIDKeys</code> in ▶ Table 3.21 Partitionable Resource Element</p> <p>If <code>@Name = "ObjectTags"</code>, then values are added to a logical pool of tag values associated with each object being processed. This pool of object tags is referenced from: <code>ColorSpaceConversionParams/ColorSpaceConversionOp/@ObjectTags</code>, <code>ScreeningParams/ScreenSelector/@ObjectTags</code>, <code>ObjectResolution/@ObjectTags</code>, <code>ColorCorrectionParams/ColorCorrectionOp/@ObjectTags</code>.</p> <p>Otherwise, <code>@Name</code> specifies the value of an implied variable (e.g., for use in <code>GeneralID/@IDUsage</code>, <code>RunList/@EndOfSet</code>, <code>RunList/@SetCopies</code>, <code>RunList/@PageCopies</code>, or <code>RunList/@DocCopies</code>).</p> <p>If <code>@DataType</code> is not "PartIDKeys" or a <code>RunList</code> implied variable name (e.g., <code>RunList/@DocCopies</code>), then the <code>MetadataMap</code> element is equivalent to explicitly defining a <code>GeneralID</code> element with the value being assigned by <code>MetadataMap/@ValueFormat</code>. The following example counts the number of <code>Page</code> elements within all <code>DocPart</code> elements.</p> <pre><MetadataMap DataType="integer" Name="NumPages" ValueFormat="%d" ValueTemplate="npages"> <Expr Name="npages" Path="count(..DocPart/Page)"> </MetadataMap></pre> <p>If multiple <code>MetadataMap</code> elements specify the same name, then the specified key has the value from the last <code>MetadataMap</code> element to assign a value to that key.</p> <p>If the specified <code>@Name</code> sets the value for a <code>@PartIDKeys</code> or <code>RunList</code> variable, where a <code>RunList</code> attribute also supplies a value (e.g., <code>RunList/@RunTag</code>, <code>RunList/@DocCopies</code>, etc.), the value supplied by the <code>RunList</code> attribute SHALL be replaced by the value supplied by the <code>MetadataMap</code>.</p>
ValueFormat	string	<p>Formatting value for combining extracted values from the <code>Expr</code> elements into a dynamic result value.</p> <p>Allowed values are from: ▶ Appendix H String Generation.</p>
ValueTemplate	string	<p>Arguments for combining extracted values from the <code>Expr</code> elements. The argument names SHALL match the values of <code>Expr/@Name</code>.</p> <p>Allowed values are from: ▶ Appendix H String Generation.</p>
Expr * Modified in JDF 1.4	element	<p>Each <code>Expr</code> element describes a <code>Term</code> expression (see ▶ Section 10.2.13 Term ▶ Section 10 Device Capabilities) evaluating metadata values in the PDL. If <code>Expr/Term</code> is not specified, or if the <code>Term</code> expression returns true, then the value specified by the <code>Expr</code> element is assigned to the key specified by <code>MetadataMap/@Name</code>. <code>Expr</code> elements are evaluated in the XML order specified. <code>Expr</code> elements with identical <code>@Name</code> attributes where a previous <code>Expr</code> element with that <code>@Name</code> has already evaluated to true SHALL NOT be processed. If any name specified in <code>MetadataMap/@ValueTemplate</code> is unassigned, then the key specified by <code>MetadataMap/@Name</code> is undefined.</p> <p>All <code>Expr</code> elements return string values. These values SHALL be type converted as necessary during processing of <code>@ValueFormat</code> and <code>@ValueTemplate</code> (See ▶ Section H String Generation).</p> <p>Note: If <code>@ValueFormat</code> contains a constant string with no format specifiers, then it is not necessary to define any <code>Expr</code> elements.</p> <p>Modification note: Starting with JDF 1.4, <code>Expr</code> MAY be omitted.</p>

9.32.1 Expr

New in JDF 1.4

Table 9.37: Expr Element (Sheet 1 of 2)

NAME	DATA TYPE	DESCRIPTION
Name	NMTOKEN	Name of this <code>Expr</code> . The value (as specified by <code>@Value</code> or extracted from <code>@Path</code>) SHALL be used to evaluate the parent <code>@ValueTemplate</code> .

Table 9.37: Expr Element (Sheet 2 of 2)

NAME	DATA TYPE	DESCRIPTION
<i>Path</i> ?	XPath	If specified, and either the value returned by the Term element (if present) is true or no Term element is specified, then the value specified by this path is assigned to Expr / <i>@Name</i> . If the XPath specified by <i>@Path</i> does not evaluate to a value such as a string or number, then this Expr element fails and any subsequent Expr elements are evaluated. If the XPath points to an element, then an implied XPath text() function SHALL be executed. The value is converted into a string when returned by the Expr element. The value returned when the XPath results in a node set is undefined. Constraint: exactly one of <i>@Path</i> or <i>@Value</i> SHALL be specified in an Expr element.
<i>Value</i> ?	string	If specified, and either the value returned by the Term element (if present) is true or no Term element is specified, then the value of this attribute is assigned to Expr / <i>@Name</i> . Constraint: exactly one of <i>@Path</i> or <i>@Value</i> SHALL be specified in an Expr element.
Term ?	element	Evaluates one or more metadata values from the PDL, and returns a true or false result. Evaluation / <i>@Path</i> SHALL be specified for all Evaluation elements in the Term hierarchy.

For PPML the XPath expression will be relative to the JOB, DOCUMENT or PAGE element. Example XPath expressions:

- “METADATA/DATUM[*@key* = “Gender”]” will extract the value of the Gender metadata for each **JDF** set, document and page.
- “count(PAGE)” will count the pages within a given document (only works for **JDF** document level nodes).
- “count(PAGE/METADATA/DATUM[*@key* = “Special”])” will count the number of pages that have a Special metadata defined for it.

MetadataMap may also be used to set the value of certain **RunList** attributes. These attributes are *@EndOfSet*, *@EndOfDocument*, *@PageCopies*, *@DocCopies* and *@SetCopies*. The values set will be instantiated as if actually present in a partitioned **RunList** for the current page or page pool being processed. Care should be taken to ensure their consistency across page pools within a document or set.

Example 9.5: MetadataMap: Setting Attributes

This example extracts the value of the *@Copies* attribute as specified by the *@Path*, and sets the value of **RunList**/*@DocCopies*.

Table 9.38: MetadataMap: Setting Attributes

VALUE	DESCRIPTION
<i>EndOfSet</i>	The last page of a set of instance document.
<i>EndOfDocument</i>	The last page of an instance document.
<i>PageCopies</i>	Number of finished page copies.
<i>DocCopies</i>	Number of instance document copies
<i>SetCopies</i>	Number of instance document set copies.

```
<RunList Class="Parameter" ID="r000004" Status="Available">
  <MetadataMap DataType="integer" Name="DocCopies" ValueFormat="%d" ValueTemplate="ncopies">
    <Expr Name="ncopies" Path="//record/document/@Copies"/>
    <Expr Name="ncopies" Value="1"/>
  </MetadataMap>
</RunList>
```

Example 9.6: RunList/MetadataMap

New in JDF 1.4

SUBELEMENTS

In the following example, the *MetadataMap* element maps arbitrary tags in the document to a structural *@RunTag* partition key.

Note: Any partition key may be mapped. Furthermore, although XPath syntax is used, this may be mapped to any hierarchical structure including but not limited to XML. Finally, note that if */Dokument/@Sektion* is a value other than "Einband" or "HauptTeil", then the *Expr* elements assigning values to section will all fail, resulting in *@RunTags* being undefined.

```

<!--this runlist points to a structured pdl with arbitrary structural
tagging-->
<RunList Class="Parameter" ID="r000004" Status="Available">
  <MetadataMap DataType="PartIDKeys" Name="RunTags"
    ValueFormat="%s%s" ValueTemplate="sex,section">
    <!--This expression maps the value of /Dokument/Rezipient/@Sex
    to a variable "sex"-->
    <Expr Name="sex" Path="/Dokument/Rezipient/@Sex"/>
    <!--Maps all elements with /Dokument/@Sektion=Einband to Cover-->
    <Expr Name="section" Value="Cover">
      <NameEvaluation Path="/Dokument/@Sektion" RegExp="Einband"/>
    </Expr>
    <!--Maps all elements with /Dokument/@Sektion=HauptTeil and >50 pages
    to BigBody-->
    <Expr Name="section" Value="BigBody">
      <and>
        <NameEvaluation Path="/Dokument/@Sektion" RegExp="HauptTeil"/>
        <IntegerEvaluation Path="count(PAGE)" ValueList="51 ~ INF"/>
      </and>
    </Expr>
    <!--Maps all elements with /Dokument/Sektion=HauptTeil and <=50 pages
    to SmallBody-->
    <Expr Name="section" Value="SmallBody">
      <and>
        <NameEvaluation Path="/Dokument/Sektion" RegExp="HauptTeil"/>
        <IntegerEvaluation Path="count(PAGE)" ValueList="0 ~ 50"/>
      </and>
    </Expr>
  </MetadataMap>
  <LayoutElement Class="Parameter">
    <FileSpec Class="Parameter"
      MimeType="application/vnd.foobar+xml" URL="bigVariable.foo"/>
  </LayoutElement>
</RunList>
<!--Layout for versioned product-->
<Layout Class="Parameter" ID="r000005" PartIDKeys="RunTags" Status="Available">
  <Layout RunTags="MaleCover">
    <MediaRef rRef="r000006">
      <Part RunTags="MaleCover"/>
    </MediaRef>
  </Layout>
  <Layout RunTags="FemaleCover">
    <MediaRef rRef="r000006">
      <Part RunTags="FemaleCover"/>
    </MediaRef>
  </Layout>
  <Layout RunTags="MaleBigBody FemaleBigBody">
    <MediaRef rRef="r000006">
      <Part RunTags="MaleBigBody MaleSmallBody FemaleBigBody
      FemaleSmallBody"/>
    </MediaRef>
  </Layout>
  <Layout RunTags="MaleSmallBody FemaleSmallBody">
    <MediaRef rRef="r000006">
      <Part RunTags="MaleBigBody MaleSmallBody FemaleBigBody
      FemaleSmallBody"/>
    </MediaRef>
  </Layout>
</Layout>
<Media Class="Consumable" ID="r000006" PartIDKeys="RunTags"
  PartUsage="Implicit" Status="Available">
  <Media RunTags="MaleCover"/>
  <Media RunTags="FemaleCover"/>
  <Media RunTags="MaleBigBody MaleSmallBody FemaleBigBody FemaleSmallBody"/>
</Media>

```

9.33 MISDetails

New in JDF 1.2

MISDetails is a container for MIS related information. It is referenced by **Audit** elements and **JMF** messages.

Element Properties

Element referenced by: **PhaseTime**, **ResourceAudit**, **ResourceCmdParams**, **ResourceInfo**, **ResourcePullParams**, **JobPhase**, **NodeInfo**

Table 9.39: MISDetails Element

NAME	DATA TYPE	DESCRIPTION
Complexity ? New in JDF 1.4	double	Complexity of the task specified by this JDF node in a range from 0.0 to 1.0. Note: The interpretation of values is implementation dependent. Values include: 0.0 – The job is simple and therefore reduced setup and waste or higher speeds are possible. 0.5 – The job is of standard complexity and therefore standard setup and waste or normal speeds are possible. 1.0 – The job is complex and therefore more setup and waste or lower speeds are possible.
CostType ?	enumeration	Specifies whether or not this MISDetails is chargeable to the customer or not. Allowed values are: Chargeable NonChargeable
DeviceOperationMode ?	enumeration	@DeviceOperationMode shows the operation mode that the device is in. It is used to show if the production of a device is aimed at producing good products or not. The latter case applies when a device is used to produce a job for testing, calibration, etc., without the intention to produce good output. Allowed values are: Productive – The device is used to produce good product. Any times recorded in this mode are to be allocated against the job. NonProductive – The device is used without the intention to produce a good product. Any times recorded in this mode are not to be allocated against the job. Maintenance – The device is used without the intention of producing a good product (e.g., to perform (preventive) maintenance).
WorkType ?	enumeration	Definition of the work type for this MISDetails (i.e., whether or not this MISDetails relates to originally planned work, an alteration or rework). Allowed values are: Alteration – Work done to accommodate a change made to the job at the request of the customer. Original – Standard work that was originally planned for the job. Rework – Work done due to unforeseen problems with the original work (bad plate, resource damaged, etc.).
WorkTypeDetails ?	string	Machine readable definition of the details of the work type for this MISDetails (i.e., why the work was done). Values include: CustomerRequest – The customer requested change(s) requiring the work. EquipmentMalfunction – Equipment used to produce the resource malfunctioned; resource needs to be created again. InternalChange – Change was made for production efficiency or other internal reason. ResourceDamaged – A resource needs to be created again to account for a damaged resource (damaged plate, etc.). UserError – Incorrect operation of equipment or incorrect creation of resource requires creating the resource again.

9.34 ObjectResolution

ObjectResolution defines a resolution depending on **@SourceObjects** data types.

Element Properties

Element referenced by: [InterpretingParams](#), [RenderingParams](#), [TrappingDetails](#)

Table 9.40: ObjectResolution Element

NAME	DATA TYPE	DESCRIPTION
AntiAliasing ? New in JDF 1.2	NMTOKEN	Indicates the anti-aliasing algorithm that the device SHALL apply to the rendered output images. An anti-aliasing algorithm causes lines and curves to appear smooth which would otherwise have a jagged appearance, especially at lower resolutions such as 300 dpi and lower. Values include: AntiAlias – Anti-aliasing SHALL be applied. The algorithm is system specified. None – Anti-aliasing SHALL NOT be applied.
ObjectTags ? New in JDF 1.4	NMTOKENS	Tags associated with individual objects that this ObjectResolution SHALL be applied to. Each tag specified in @ObjectTags is logically AND’ed with the object type(s) specified by @SourceObjects , enabling first qualification by object type (such as image), and then tags associated with those objects. The values of @ObjectTags depends on the PDL that the ObjectResolution is applied to. @ObjectTags SHALL apply only to objects whose tag pool includes all the tags in the value of @ObjectTags .
Resolution	XYPair	Horizontal and vertical output resolution in DPI.
SourceObjects ? Modified in JDF 1.6	enumerations	Identifies the class(es) of incoming graphical objects to render at the specified resolution. If @SourceObjects is not specified then ObjectResolution SHALL apply to all object classes. Allowed values are from: ▶ SourceObjects .

9.35 OCGControl

New in JDF 1.3

OCGControl defines the policy for including or excluding layers that are encoded as ‘Optional Content Groups’ (OCGs) in PDF.

The order of [OCGControl](#) elements SHALL have no effect; the Z-order of graphic elements that make up each optional content group (the term layer is misleading in this regard) within the PDF file SHALL define the drawing order of those graphic elements.

Any preferences recorded in an OCG within the PDF file as to whether that OCG SHOULD be displayed or not SHALL be ignored if that OCG is referenced from an [OCGControl](#) element.

The state of all OCGs explicitly referenced from [OCGControl](#) elements SHALL be set before determining the state of any remaining OCGs.

Note: All controls for OCGs in **XJDF** address OCGs directly, and not Optional Content Member Dictionaries (OCMDs do not have unique names).

Note: ▶ [PDF1.6] does not state that all OCGs SHALL have unique names. It is therefore possible for a single PDF file to contain multiple OCGs with the same name. When [OCGControl](#)/[@OCGName](#) refers to multiple OCGs in a file, they will all be explicitly included or excluded together.

Element Properties

Element referenced by: [PDFInterpretingParams](#)

Table 9.41: OCGControl Element (Sheet 1 of 2)

NAME	DATA TYPE	DESCRIPTION
IncludeOCG="true"	boolean	Defines whether the optional content group(s) identified by @OCGName are to be included in the RunList . If "true", then the layer SHALL be included. If "false", it SHALL NOT. The contents stream of excluded OCGs SHALL still be interpreted so that changes to CTM, etc., are acted on. The objects drawn in excluded OCGs SHALL NOT be rendered.

Table 9.41: OCGControl Element (Sheet 2 of 2)

NAME	DATA TYPE	DESCRIPTION
<i>OCGName</i> ?	string	The name of the optional content group(s) that SHALL be included or excluded. Exactly one of <i>@OCGName</i> or <i>@ProcStepsGroup</i> SHALL be present. Note: The Name attribute of an optional content group entry is encoded as a PDF text string, and <i>@OCGName</i> is encoded with the Unicode variant identified in the XJDF file header; names SHALL be re-encoded as necessary for comparison.
<i>ProcStepsGroup</i> ? New in JDF 1.6	NMTOKEN	An OCG is selected, if <i>@ProcStepsGroup</i> matches the value of GTS_ProcStepsGroup in the GTS_Metadata dictionary of the OCG of a PDF that complies with ▶ [ISO19593-1:2016].
<i>ProcStepsType</i> ? New in JDF 1.6	NMTOKEN	If specified, an OCG is selected, if <i>@ProcStepsType</i> matches the value of GTS_ProcStepsType in the GTS_Metadata dictionary of the OCG of a PDF that complies with ▶ [ISO19593-1:2016]. <i>@ProcStepsType</i> SHALL NOT be specified unless <i>@ProcStepsGroup</i> is present.

9.36 Perforate

Perforate describes one perforated line.

Element Properties

Element referenced by: *PerforatingParams*

Table 9.42: Perforate Element

NAME	DATA TYPE	DESCRIPTION
<i>Depth</i> ? New in JDF 1.2	double	Depth of the perforation, in microns [µm].
<i>RelativeStartPosition</i> ? New in JDF 1.2	XYPair	Relative starting position of the tool. The <i>@RelativeStartPosition</i> is always based on the complete size of the input Component and not on the size of an intermediate state of the folded sheet. The allowed value range is from 0.0 to 1.0 for each component of the XYPair, which specifies the full size of the input Component . At least one of <i>@StartPosition</i> or <i>@RelativeStartPosition</i> SHALL be specified.
<i>RelativeWorkingPath</i> ? New in JDF 1.2	XYPair	Relative working path of the tool beginning at <i>@RelativeStartPosition</i> . Since the tools can only work parallel to the edges, one coordinate SHALL be zero. The <i>@RelativeWorkingPath</i> is always based on the complete size of the input Component and not on the size of an intermediate state of the folded sheet. The allowed value range is from 0.0 to 1.0 for each component of the XYPair, which specifies the full size of the input Component . At least one of <i>@WorkingPath</i> or <i>@RelativeWorkingPath</i> SHALL be specified.
<i>StartPosition</i> ? Modified in JDF 1.2	XYPair	Starting position of the tool. If both <i>@StartPosition</i> and <i>@RelativeStartPosition</i> are specified, <i>@RelativeStartPosition</i> is ignored. At least one of <i>@StartPosition</i> or <i>@RelativeStartPosition</i> SHALL be specified.
<i>TeethPerDimension</i> ?	double	Number of teeth in a given perforation extent in teeth/point. MicroPerforation is defined by specifying a large number of teeth (<i>@TeethPerDimension</i> > 1000).
<i>WorkingDirection</i> ? Modified in JDF 1.5	enumeration	Direction from which the tool is working. Allowed value is from: ▶ WorkingDirection. Modification note: Starting in JDF 1.5, <i>@WorkingDirection</i> is optional.
<i>WorkingPath</i> ? Modified in JDF 1.2	XYPair	Working path of the tool beginning at <i>@StartPosition</i> . Since the tools can only work parallel to the edges, one coordinate SHALL be zero. If both <i>@WorkingPath</i> and <i>@RelativeWorkingPath</i> are specified, <i>@RelativeWorkingPath</i> is ignored. At least one of <i>@WorkingPath</i> or <i>@RelativeWorkingPath</i> SHALL be specified.

9.37 Person

Person provides detailed information about a person. The structure of **Person** is derived from the vCard format, see ▶ [vCard]. The corresponding XML types of the vCard are quoted in the description field of the table below.

Element Properties

Element referenced by: [Contact](#), [Employee](#)

Table 9.43: Person Element

NAME	DATA TYPE	DESCRIPTION
AdditionalNames ?	string	Additional names of the contact person (vCard: N:other).
FamilyName ?	string	The family name of the contact person (vCard: N:family).
FirstName ?	string	The first name of the contact person (vCard: N:given).
JobTitle ?	string	Job function of the person in the company or organization (vCard: title).
Languages ? New in JDF 1.4	languages	List of languages related to the person, ordered by decreasing preference
NamePrefix ?	string	Prefix of the name, can include title (vCard: N:prefix).
NameSuffix ?	string	Suffix of the name (vCard: N:suffix).
PhoneticFirstName ? New in JDF 1.5	string	Alternative spelling of a first name. Used (e.g., for pronunciation of Kanji (Japanese) names). See ▶ [vCard].
PhoneticLastName ? New in JDF 1.5	string	Alternative spelling of a last name. Used (e.g., for pronunciation of Kanji (Japanese) names). See ▶ [vCard].
Address ? New in JDF 1.2	element	Address of the person.
ComChannel *	element	Communication channels to the person

9.38 RefAnchor

New in JDF 1.4

RefAnchor describes the relative position with respect to a related element in a layout. Depending on the value of [@AnchorType](#), it specifies either a parent element or a sibling element.

Element Properties

Element referenced by: [Layout/MarkObject](#), [LayoutElementProductionParams/LayoutElementPart/PositionObj](#), [StrippingParams/StripMark](#)

Table 9.44: RefAnchor Element

NAME	DATA TYPE	DESCRIPTION
Anchor ?	enumeration	@Anchor specifies the origin (0,0) of the vector specified in the rotated coordinate system of the related layout element. Allowed value is from: ▶ Anchor .
AnchorType ?	enumeration	Role of this RefAnchor . Allowed values are: Parent – The layout element referenced by this RefAnchor is a parent. This layout element is transformed with the parent. Sibling – The layout element referenced by this RefAnchor is a sibling. Both layout elements share a common parent. The parent of this layout element SHALL be specified as the RefAnchor of the first child in the chain of siblings.
rRef ?	IDREF	Reference to a layout element that this layout element is positioned relative to. If @rRef is not specified, the page or sheet defined by the layout element is the parent container. @rRef SHALL be specified if @AnchorType = "Sibling".

9.39 RegisterRibbon

New in JDF 1.1

Description of a register ribbon used for book binding. The relationship of visible, hidden and overall length of the register ribbon is shown in ▶ Figure 9-2: RegisterRibbon lengths and coordinate system for BlockPreparation.

Element Properties

Element referenced by: [BindingIntent/HardCoverBinding, BlockPreparationParams](#)

Table 9.45: RegisterRibbon Element

NAME	DATA TYPE	DESCRIPTION
<i>LengthOverall</i> ? Modified in JDF 1.4	double	Overall length of the register ribbon. See ▶ Figure 9-2: RegisterRibbon lengths and coordinate system for BlockPreparation. Modification note: Starting with JDF 1.4 , <i>@LengthOverall</i> is optional.
<i>Material</i> ?	string	Material of the register ribbon.
<i>RibbonColor</i> ?	enumeration	<i>@RibbonColor</i> specifies the machine readable color of ribbon. Allowed value is from: ▶ NamedColor.
<i>RibbonColorDetails</i> ? New in JDF 1.4	string	A more specific, specialized or site-defined name for the color. If <i>@RibbonColorDetails</i> is supplied, <i>@RibbonColor</i> SHOULD also be supplied.
<i>RibbonEnd</i> ?	NMTOKEN	End of the Ribbon. Values include: Cut CutSealed Knot SealedOffset – The ribbon is sealed some distance from the cut.
<i>VisibleLength</i> ? Modified in JDF 1.4	double	Length of the register ribbon that will be seen when opening the book. See ▶ Figure 9-2: RegisterRibbon lengths and coordinate system for BlockPreparation. Modification note: Starting with JDF 1.4 , <i>@VisibleLength</i> is optional.

Figure 9-2: RegisterRibbon lengths and coordinate system for BlockPreparation

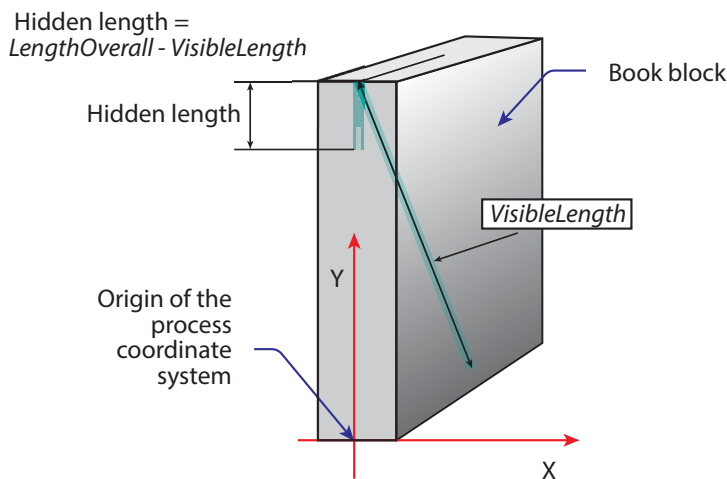

9.40 ScreenSelector

Description of screening for a selection of source object types and separations.

Element Properties

Element referenced by: [ColorSpaceConversionOp](#), [ScreeningParams](#)

Table 9.46: ScreenSelector Element (Sheet 1 of 2)

NAME	DATA TYPE	DESCRIPTION
Angle ?	double	Specifies the first angle of the screen when AM screening is used, otherwise @Angle is ignored. At most one of @Angle or @AngleMap SHALL be specified. If neither @Angle nor @AngleMap are specified, the angle is determined by the default of the selected @ScreeningFamily .
AngleMap ? New in JDF 1.1	string	Specifies the mapping of the angle of the screen to the angle of a different separation when AM screening is used. For example, a spot color that has the same screening angle as the cyan separation is specified by @AngleMap = "Cyan". In FM screening, @AngleMap specifies the mapping of the separation specific screen functions (e.g., threshold arrays). At most one of @Angle or @AngleMap SHALL be specified. This mapping is not transitive, so, when @Separation already specifies a color with a known default, it specifies the angle of the separation defined by @AngleMap prior to that separation being mapped. Note: In general, the known default will be a CMYK process color, but it can also be another process color (e.g., HexaChrome™). The following example specifies that "Black" is to be mapped to the "Cyan" default separation and "Cyan" to the "Black" default separation. The third line maps Spot1 to Magenta. <pre><ScreenSelector AngleMap="Black" Separation="Cyan"/> <ScreenSelector AngleMap="Cyan" Separation="Black"/> <ScreenSelector AngleMap="Magenta" Separation="Spot1"/></pre>
DotSize ? New in JDF 1.1	double	Specifies the dot size of the screen, in microns [µm], when FM screening (@ScreeningType = "FM" or "Adaptive") is used, otherwise @DotSize is ignored.
Frequency ? Modified in JDF 1.2	double	Specifies the halftone screen frequency in lines per inch (lpi) of the screen when AM screening is used, otherwise @Frequency is ignored. With some screens, frequency can change as a function of gray level. In this case, the @Frequency value is interpreted for a mid tone (50%) gray level. If @Frequency is not specified, the frequency is determined by the default of the selected @ScreeningFamily .
ObjectTags ? New in JDF 1.4	NMTOKENS	Tags associated with individual objects that this ScreenSelector SHALL be applied to. Each tag specified in @ObjectTags is logically AND'ed with the object type(s) specified by @SourceObjects , enabling first qualification by object type (such as image), and then tags associated with those objects. The values of @ObjectTags depends on the PDL that the ScreenSelector is applied to. @ObjectTags SHALL apply only to objects whose tag pool includes all the tags in the value of @ObjectTags .
ScreeningFamily ?	string	Vendor specific screening family name. Sample values removed in JDF 1.2
ScreeningType ? Modified in JDF 1.2	enumeration	General type of screening. Allowed values are: Adaptive AM – Can be line or dot. See @SpotFunction . ErrorDiffusion FM – Includes all stochastic screening types. HybridAM-FM HybridAMline-dot
Separation = "All"	string	The name of the separation. If @Separation = "All", the ScreenSelector SHALL be applied to all separations that are not specified explicitly. Values include: All
SourceFrequency ? Modified in JDF 1.2	DoubleRange	Specifies the line frequency of screens which SHALL be matched from the source file when screen matching is to be done. Note: This is a filter that selects on which objects to apply this ScreenSelector .

Table 9.46: ScreenSelector Element (Sheet 2 of 2)

NAME	DATA TYPE	DESCRIPTION
SourceObjects ? Modified in JDF 1.6	enumerations	Identifies the class(es) of incoming graphical objects on which to use the selected screen. If @SourceObjects is not specified then ScreenSelector SHALL apply to all object classes. Allowed values are from: ▶ SourceObjects.
SpotFunction ?	NMTOKEN	Specifies the spot function of the screen when AM screening is used. In general, it is common for a spot function to change its shape as a function of gray level. Response to these spot function names MAY be implementation-dependent. These example names are the same as the spot function names defined in PDF. Values include: CosineDot Cross Diamond Double DoubleDot Ellipse EllipseA EllipseB EllipseC InvertedDouble InvertedDoubleDot InvertedEllipseA InvertedEllipseC InvertedSimpleDot Line LineX LineY Rhomboid Round SimpleDot Square

9.41 SeparationSpec

This element specifies a specific separation, and is usually used to define a list or sequence of separations.

Element Properties

Element referenced by: [ColorsUsed](#), [ProofItem](#), [ColorantAlias](#), [ColorantConvertProcess](#), [ColorantOrder](#), [ColorantParams](#), [DeviceColorantOrder](#), [ColorSpaceSubstitute](#), [ColorControlStrip](#), [ColorSpaceConversionOp](#), [ContentData](#), [DeviceNSpace](#), [LayoutElement](#), [PageList](#), [PageData](#), [RegisterMark](#), [ScavengerArea](#), [CutLines](#), [SeparationListBack](#), [SeparationListFront](#), [TrappingOrder](#)

Table 9.47: SeparationSpec Element

NAME	DATA TYPE	DESCRIPTION
Name ?	string	Name of one specific separation. If @Name is not specified, this SeparationSpec consumes a slot in a separation order without setting a separation, for instance when specifying modules to skip on a press or color fields to leave blank in a ColorControlStrip . Modification note: Starting with JDF 1.4 , @Name is optional.

9.42 SubscriptionInfo

New in JDF 1.4

A [SubscriptionInfo](#) element describes the [Subscription](#) details of a persistent channel.

Element Properties

Element referenced by: [StopPersistentChannel](#)

Table 9.48: SubscriptionInfo Element

NAME	DATA TYPE	DESCRIPTION
ChannelID	NMTOKEN	@ChannelID specifies the ID of the Query message (identical to the @refID of the signal or response message).
Family	enumeration	Specifies whether the persistent channel is a signal or command. Allowed values are: Signal Command
JobID ? Deprecated in JDF 1.5	string	@JobID of the JDF node that this persistent channel applies to. If not specified, this persistent channel applies to all @JobID values. Deprecation note: Job specific subscriptions are discouraged.
JobPartID ? Deprecated in JDF 1.5	string	@JobPartID of the JDF node that this persistent channel applies to. If not specified, this persistent channel applies to all @JobPartID values. Deprecation note: Job specific subscriptions are discouraged.
MessageType	NMTOKEN	Message/@Type value of the subscribed messages.
QueueEntryID ? Deprecated in JDF 1.5	string	@QueueEntryID of the QueueEntry that this persistent channel applies to. If not specified, this persistent channel applies to all @QueueEntryID values. Deprecation note: Job specific subscriptions are discouraged.
SenderID	string	Identifier of the controller that subscribed for the persistent channel. @SenderID SHALL match the value of Query/@SenderID of the query that subscribed for this persistent channel.
Part * Deprecated in JDF 1.5	element	Part elements that describe the partition of the JDF node that this persistent channel applies to. For details on node partitions, see ▶ Section 4.3.2 Partial processing of nodes with Partitioned resources. Deprecation note: Job specific subscriptions are discouraged.
Subscription	element	The Subscription element that describes the persistent channel.

10 Device Capabilities

Introduction

The **JDF** specification and schema describe the entire space of parameters and resources that can be used to control any device. Each actual device has limitations in the **JDF** that it can correctly process. For instance, a RIP will typically not process folding instructions. Even if a set of parameters is processed, physical limitations may restrict the possible values. For instance media sizes are theoretically unbounded, but any real device will have a minimum and maximum sheet size. The specification also assumes that parameters may be set independently. This not always correct so that the value of one trait may constrain the value of another trait. For instance a printer may support transparent media and duplex printing, but it will probably be constrained not to support both in the same job.

10.1 Capability and Constraint Definitions

New in JDF 1.1

While the **JDF** schema describes the structure of all **JDF** nodes, it does not provide for a way to allow a specific **JDF** device to provide details on how it subsets (or extends) the **JD** language. This ability is provided by the **JDF** device capabilities features. With it, a **JDF** device can describe details on supported processes, resources, attributes and attribute values (and details about constraints and their interaction).

Figure 10-1: Parameter space in Device Capabilities^a

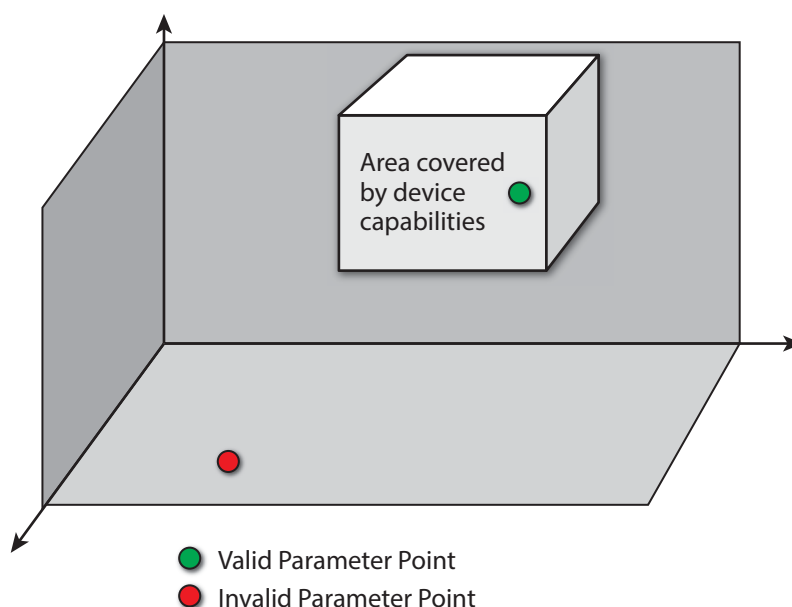

- a. Note that the restriction to three dimensions is for graphical demonstration purposes only.

A **JDF** device's capabilities are described as a space of allowed resource parameter values within **JDF** nodes. A device in this context is assumed to execute one or more **JDF** nodes. Its capabilities are defined by the space of acceptable **JDF** resources for the product intent or process described by the node. An individual **JDF** node definition can be compared to the capabilities of a **JDF** device by looping over all resource parameters of a **JDF** node that is to be executed by a device. The job can be executed as specified (attributes can be ignored if the `@SettingsPolicy` is "BestEffort") if all job parameter values are within the ranges specified by the capabilities. If the capabilities describe product intent, the job is executable as specified when all product intent ranges overlap with the capabilities description.

Details of the elements needed for capability description are specified in ▶ Chapter 10 Device Capabilities.

DEVICE CAPABILITIES

It is assumed that **Device** resources that describe capabilities will be transported in **JMF KnownDevices** messages. However, a **Device** resource SHOULD NOT specify the capabilities of its associated **Device** if a **JDF** node links to the **Device**, in order to specify that the **Device** is intended to execute the node.

A capabilities description can also provide information necessary for the construction of a user interface to allow entry of the values to use for a **JDF** node. This includes specifying the NMTOKEN, enumeration or string values that are supported, hints for how to group features on the user interface, and macro definitions for features of the device (allowing multiple **JDF** controls to be presented as a single user control).

10.2 Device Capability Definitions

New in JDF 1.1

The elements in this section are used to specify capabilities of **JDF** devices and provide infrastructure for defining preflight rules, including conducting a “**JDF** test run” and establishing a handshake between **JDF**-enabled products. When describing capabilities, note that only attributes and elements that are explicitly described within the capabilities structure are supported by the device. For more details on preflight, see ▶ Section 6.3.27 Preflight.

Capabilities descriptions that are saved in files SHALL be formatted as a **JMF/Signal/Response** to the **KnownDevices** query message.

10.2.1 DeviceCap

New in JDF 1.1

The **DeviceCap** element describes the **JDF** nodes and resources that a device is capable of processing. elements that are derived from the abstract **State** elements are used to describe ranges and lists of ranges of allowed parameters.



Preflighting in Device Capabilities

While the actions and tests described in this section as pertaining to “preflighting” can be used by processes and resources that pertain to preflighting in the conventional sense, they can also be used to conduct “JDF test runs.” A JDF test run might be part of a normal preflighting workflow, but the idea of a “JDF test run” is to compare the requirements of a JDF document or instance against the capabilities and JDF support of a device or an integrated JDF environment.

Figure 10-2: DeviceCap – a diagram of its structure

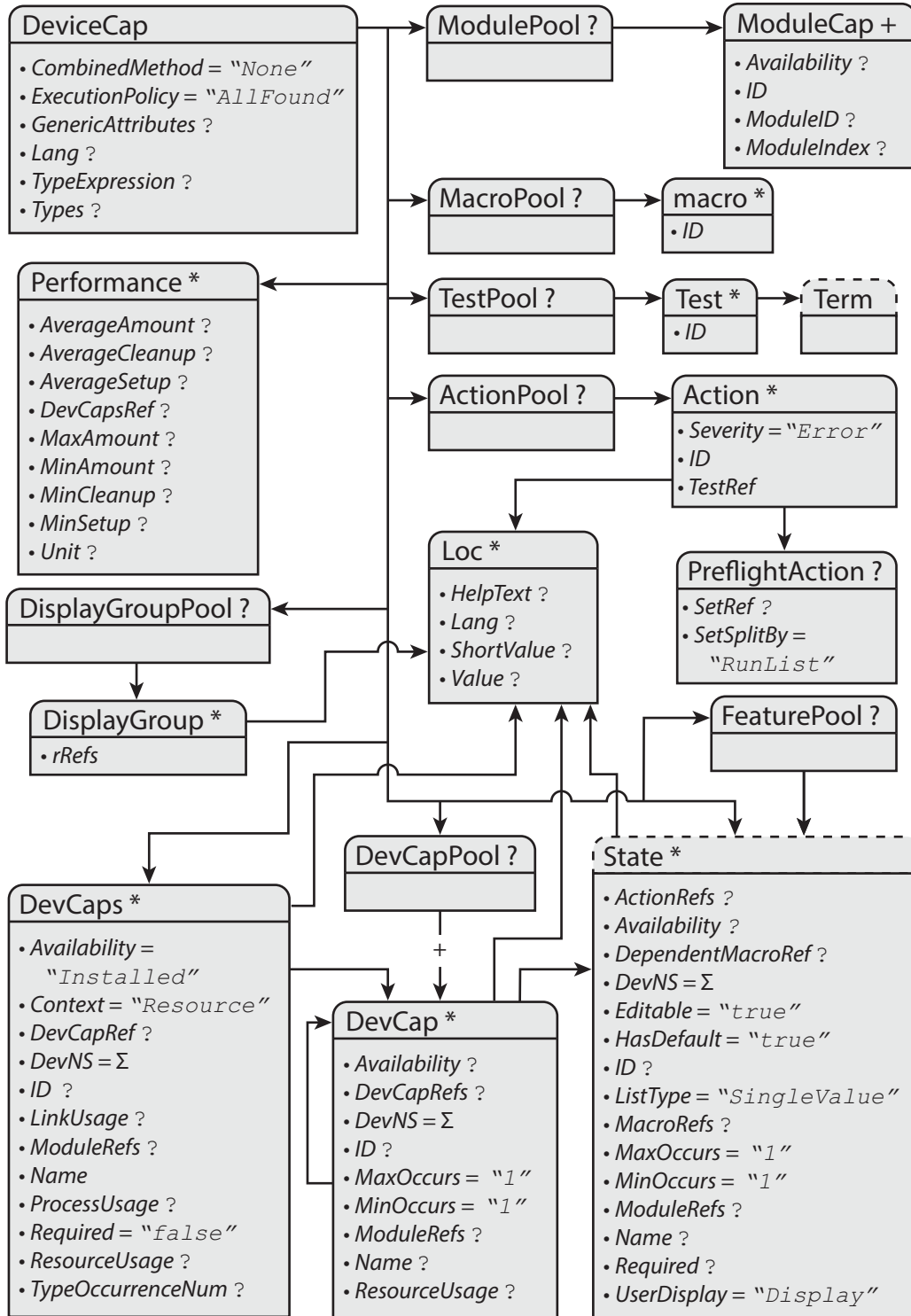

Table 10.1: DeviceCap Element (Sheet 1 of 2)

NAME	DATA TYPE	DESCRIPTION
<p><i>CombinedMethod</i> = "None" Modified in JDF 1.3</p>	<p>enumerations</p>	<p>Specifies how the processes specified in <i>@Types</i> are to be specified. If multiple values are specified, the structure of the JDF SHALL match one of the values.</p> <p>Allowed values are:</p> <p>Combined – The list of processes in <i>@Types</i> SHALL be specified as a combined process.</p> <p>CombinedProcessGroup – The list of processes in <i>@Types</i> SHALL be specified either as a combined process or as a "ProcessGroup" of individual processes. In JDF 1.3 and beyond, the pair of individual tokens: "Combined ProcessGroup" replace this single value. Deprecated in JDF 1.3</p> <p>GrayBox – The list of processes in <i>@Types</i> SHALL be specified in a "ProcessGroup" with no nested JDF nodes (i.e., a Gray Box). New in JDF 1.3</p> <p>ProcessGroup – The list of processes in <i>@Types</i> SHALL be specified as a "ProcessGroup" of individual processes.</p> <p>None – No support for "Combined", "GrayBox" or "ProcessGroup". Only one individual process type defined in <i>@Types</i> is supported.</p>
<p><i>ExecutionPolicy</i> = "AllFound" New in JDF 1.2</p>	<p>enumeration</p>	<p>Describes the policy for finding and executing JDF nodes as described in ▶ Section 4.2.1 Determining Executable nodes.</p> <p>Allowed values are:</p> <p>RootNode – The device will execute the root JDF node only. It will not search the JDF tree for executable nodes. This will commonly be used for sub JDF nodes that have been spawned and targeted explicitly for the device.</p> <p>FirstFound – The device will execute the first node found in the JDF tree that is executable by this device. The search order is defined by the order in the XML.</p> <p>AllFound – The device will execute all executable nodes found in multiple passes of the JDF tree that are executable by this device. The results of executing a node are applied to the tree between passes.</p>
<p><i>GenericAttributes</i> ?</p>	<p>NMTOKENS</p>	<p>List of all generic attributes that are supported and unrestricted by the device implementation. Descriptions of attributes that appear in <i>State</i> elements (see the following ▶ Section 10.2.7 State) overwrite the description in <i>@GenericAttributes</i>.</p>
<p><i>Lang</i> ? New in JDF 1.2</p>	<p>languages</p>	<p>Specifies the localization(s) provided with the capabilities. If not specified, no localizations are provided.</p>
<p><i>OptionalCombinedTypes</i> ? Deprecated in JDF 1.2</p>	<p>NMTOKENS</p>	<p>List of optional JDF node types. The entries of the list SHALL be a subset of <i>@Types</i>.</p> <p>Values include those from: ▶ Chapter 6 Processes.</p> <p>Example: a RIP with optional in-RIP trapping would specify <i>@OptionalCombinedTypes</i> = "Trapping" if <i>@Types</i> = "Trapping Interpreting Rendering".</p> <p>Deprecation note: Starting with JDF 1.2, use <i>@TypeExpression</i>.</p>
<p><i>Type</i> ? Deprecated in JDF 1.2</p>	<p>NMTOKEN</p>	<p>JDF <i>@Type</i> attribute of the supported process. Extension types MAY be specified by stating the namespace prefix in the value.</p> <p>Values include those from: ▶ Chapter 6 Processes.</p> <p>Deprecation note: Starting with JDF 1.2, a single value of type is also defined in the <i>@Types</i> attribute.</p>
<p><i>TypeExpression</i> ? New in JDF 1.2</p>	<p>regExp</p>	<p>Regular expression that defines the allowed values of the node's <i>@Types</i> attribute. If not specified, defaults to the literal string defined in <i>@Types</i> (i.e., the ordered list of processes defined in <i>@Types</i> SHALL match exactly).</p> <p>Constraint: in JDF 1.2 and above, one of <i>@Types</i> or <i>@TypeExpression</i> SHALL be specified.</p>

Table 10.1: DeviceCap Element (Sheet 2 of 2)

NAME	DATA TYPE	DESCRIPTION
<i>TypeOrder</i> ? Deprecated in JDF 1.2	enumeration	Ordering restriction for combined process nodes and process group nodes. Allowed values are: Fixed – The order of process types specified in the @Types attribute is ordered, and each type can be specified only once (e.g., @Cutting, @Folding). Order does matter. Unordered – The order of process types specified in the @Types attribute is unordered, and each type can be specified only once (e.g., "DigitalPrinting Screening Trapping"). Order does not matter. Unrestricted – The order of process types specified in the @Types attribute is unordered, and each type can be specified in multiples (e.g., "Cutting Folding"). The device can handle both processes, in any order, multiple times. Deprecation note: Starting with JDF 1.2, use @TypeExpression.
<i>Types</i> ? Modified in JDF 1.2	NMTOKENS	This attribute represents the list of supported JDF node @Type values. If any of the node types are in a namespace other than JDF, the namespace prefix SHALL be included in this node type name. The ordering is significant unless it is overridden by @TypeExpression. Constraint: in JDF 1.2 and above, one of @Types or @TypeExpression SHALL be specified. Values include those from: ▶ Chapter 6 Processes.
<i>ActionPool</i> ? New in JDF 1.2	element	Container for Action elements for use as constraints.
<i>DevCapPool</i> ? New in JDF 1.3	element	Pool of DevCap elements that can be referenced from multiple elements within the DeviceCap structure.
<i>DevCaps</i> *	element	List of definitions of the accepted resources and elements. The DevCaps elements are combined with a logical AND (i.e., a JDF SHALL fulfill all restrictions defined by the set of DevCaps). Only resources that are specified within this list are honored by the device.
<i>DisplayGroupPool</i> ? New in JDF 1.2	element	List of DisplayGroup subelements, which define the user interface presentation of sets of related DevCap attribute values. This is metadata to provide assistance in user interface display layout.
<i>FeaturePool</i> ? New in JDF 1.2	element	List of definitions of the accepted parameter space for resources and messages that are for user interface definition only — they do not map to actual JDF resources or messages. Definitions in FeaturePool typically reference macros that manipulate a set of related resource values. These macros will set the appropriate JDF attribute values.
<i>MacroPool</i> ? New in JDF 1.2	element	Container for zero or more macro elements, each of which contains an expression that can cause @State attribute values (e.g., "CurrentValue" or "UserDisplay") to be changed.
<i>ModulePool</i> ? New in JDF 1.3	element	Pool of ModuleCap elements that specify the availability of a given module.
<i>Performance</i> *	element	Specification of a devices' performance capabilities.
<i>TestPool</i> ? New in JDF 1.2	element	Container for zero or more Test elements that are referenced from ActionPool/Action elements.
<i>State</i> * New in JDF 1.3	element	Abstract State Elements that define the parameter space that is covered by the device. One State element SHALL be defined for each supported attribute of the JDF node that is not specified @GenericAttributes or implied by @TypeExpression or @Types.

10.2.2 ActionPool

New in JDF 1.2

The ActionPool subelement is used to contain boolean expressions that have two purposes:

- As capability constraints to describe unsupported combinations of State process, and attribute values.

DEVICE CAPABILITIES

- As preflight constraints to describe unsupported combinations of basic **PreflightReport** values. (See Structure of the abstract **Evaluation** subelement in ▶ Section 10.2.13 Term.

Note: The definition of the **Term** element also describes how boolean operators are employed by **Action** elements via the **@TestRef** attribute.)

ActionPool and the **Action** elements it can contain, is interdependent on **TestPool** and the **Test** and **Term** elements it can contain. For more information on **TestPool**, see ▶ Section 10.2.12 TestPool.

Table 10.2: ActionPool Element

NAME	DATA TYPE	DESCRIPTION
Action *	element	A list of independent Action elements.

10.2.2.1 Action

The **Action** subelement is used to contain boolean expressions that are used to describe a constraint that describes an unsupported combination of **State** process and attribute values. If the **Test** referenced by **@TestRef** evaluates to "true", the combination of processes and attribute values described is not allowed, and the action indicated by "Error", "Warning" or "Information" in the **@Severity** attribute SHALL be taken.

Table 10.3: Action Element

NAME	DATA TYPE	DESCRIPTION
ID	ID	Unique identifier of the Action element. This ID is used to refer to the Action element (e.g., from a preflight report).
Severity = "Error"	enumeration	Indicates how the severity of the failure SHALL be treated when the expression defined by @TestRef is violated. Allowed values are: Error – The client SHALL display an error message and not allow the conflicting settings to persist. Warning – The client SHALL notify the user of the condition but allow the settings to persist if the user requests. Information – The client SHALL allow the settings to persist but inform the user of the issue.
TestRef	IDREF	Reference to a Test element that is executed to evaluate this Action .
Loc *	element	Text to describe an error if the Test fails. See ▶ Section 10.2.5.1 Loc.
PreflightAction ?	element	Provides additional constraints that are specific to the Preflight process. See ▶ Section 8.111 PreflightParams.

10.2.3 DevCapPool

New in JDF 1.3

The **DevCapPool** provides a container for descriptions of elements that are referenced from multiple locations within the **JDF**.

Table 10.4: DevCapPool Element

NAME	DATA TYPE	DESCRIPTION
DevCap +	element	DevCap elements that can be referenced from multiple locations within the DeviceCap structure. DevCap / @ID SHALL be specified for all DevCap elements in DevCapPool .

10.2.4 ModulePool

New in JDF 1.3

Table 10.5: ModulePool Element

NAME	DATA TYPE	DESCRIPTION
ModuleCap +	element	ModuleCap elements that can be referenced from within the DeviceCap structure to specify features that depend on a given module being installed.

10.2.4.1 ModuleCap

New in JDF 1.3

Module elements specify features that depend on given hardware or software modules being installed. Hardware examples include duplex units for printers. Software licensing keys MAY also be modeled as modules.

Table 10.6: ModuleCap Element

NAME	DATA TYPE	DESCRIPTION
<i>Availability</i> ?	enumeration	Specifies whether the feature described by this <i>State</i> element is available on the device. Allowed values are: <i>Installed</i> – The feature is installed on the device and is available for use. <i>Module</i> – "Module" is not to be specified recursively in a <i>ModuleCap</i> . This value is only specified here to have a common enumeration set for all <i>@Availability</i> attributes. <i>NotInstalled</i> – The feature has not been installed on the device. <i>NotLicensed</i> – The feature has been installed on the device but can not be used until licensed. <i>Disabled</i> – The feature is installed and licensed on the device, but has been disabled.
<i>ID</i>	ID	@ID of the <i>ModuleCap</i> .
<i>ModuleID</i> ?	integer	ID of the module that this <i>ModuleCap</i> describes. Refers to <i>Device/Module/@ModuleID</i> . If neither <i>@ModuleID</i> nor <i>@ModuleIndex</i> are specified, no further details of the <i>Module</i> are known.
<i>ModuleIndex</i> ?	integer	Index of the module that this <i>@ModuleCap</i> describes. Refers to <i>Device/Module/@ModuleIndex</i> . If neither <i>@ModuleID</i> nor <i>@ModuleIndex</i> are specified, no further details of the <i>Module</i> are known.

10.2.5 DevCaps

New in JDF 1.1

The *DevCaps* element describes the valid parameter space of a *JDF* resource, message or *ResourceLink* that is consumed, honored or produced by a device. Note that *DevCaps* not only describes the structure of the individual *Resource* and *ResourceLink* elements but also of the *AuditPool* or other direct child elements within a *JDF* node. The *DevCaps* element MAY be used to model *Intent Resources* as well as process definition resources.

Table 10.7: DevCaps Element (Sheet 1 of 3)

NAME	DATA TYPE	DESCRIPTION
<i>Availability</i> = "Installed" New in JDF 1.2	enumeration	Specifies whether the feature described by this <i>DevCaps</i> element is available on the device. Allowed values are: <i>Installed</i> – The feature is installed on the device and is available for use. <i>Module</i> – The feature is provided by a module specified in <i>@ModuleRefs</i> . If and only if all modules that are listed in <i>@ModuleRefs</i> are available, is the feature available. New in JDF 1.3 <i>NotInstalled</i> – The feature has not been installed on the device. <i>NotLicensed</i> – The feature has been installed on the device but can not be used until licensed. <i>Disabled</i> – The feature is installed and licensed on the device but has been disabled.
<i>Context</i> = "Resource" New in JDF 1.2 Modified in JDF 1.3	enumeration	Describes whether the <i>DevCaps</i> context is within a resource or a link to a resource (not applicable to <i>DevCaps</i> elements within messages). Allowed values are: <i>Element</i> – The <i>DevCaps</i> context describes a direct element (e.g., an <i>AuditPool</i>). <i>JMF</i> – The <i>DevCaps</i> context describes a <i>JMF</i> message. <i>Link</i> – The <i>DevCaps</i> context describes a link to a resource. <i>Resource</i> – The <i>DevCaps</i> context describes a resource.

Table 10.7: DevCaps Element (Sheet 2 of 3)

NAME	DATA TYPE	DESCRIPTION
DevCapRef ? New in JDF 1.3	IDREFS	Reference to reusable DevCap elements that are located in DeviceCap/DevCapPool . A reference to a DeviceCap/DevCapPool/DevCap is equivalent to an inline DevCap in this DevCaps . Exactly one of @DevCapRef or DevCap SHALL be specified.
DevNS = "http://www.CIP4.org/JDFSchema_1_1"	URI	Namespace of the resource or message that is described.
ID ? New in JDF 1.2	ID	ID of this DevCaps element. Used for reference from Performance elements.
LinkUsage ? New in JDF 1.2	enumeration	Used when the @Context of this DevCaps = "Resource" or "Link". This field qualifies whether the DevCaps describes a resource used as an input to a process, or as the output of a process. Default behavior: this DevCaps applies to both usages. Allowed values are: Input – The DevCaps describes an input resource. Output – The DevCaps describes an output resource.
ModuleRefs ? New in JDF 1.3	IDREFS	List of modules that are needed for this feature to be available. At least one entry SHALL be specified if @Availability = "Module". The list of modules is specified in DeviceCap/ModulePool .
Name Modified in JDF 1.3	NMTOKEN	Name of the element excluding the namespace prefix. When describing parameters of a ResourceLink , @Name SHALL be the name of the referenced resource and @Context = "Link". When DevCaps is specified as a subelement of MessageService , @Name specifies the respective CommandTypeObj , QueryTypeObj or ResponseTypeObj of the JMF message. Modification note: Starting with JDF 1.3, @Name SHALL always specify the actual resource name. Before JDF 1.3, the @ResourceUsage and @ProcessUsage of a resource are specified in this attribute. Values include those from: ▶ Chapter 10 Device Capabilities.
ProcessUsage ? New in JDF 1.3	NMTOKEN	ResourceLink/@ProcessUsage of the link to the resource that is described by this DevCaps . Values include those from: ▶ Process Usage.
Required = "false" New in JDF 1.2	boolean	If "true", the element described by this DevCaps element SHALL be present in a JDF or JMF (as appropriate) submitted to the device. Note that this does not override the cardinality defined by the JDF specification when the specification requires the resource to be specified. If an attribute is REQUIRED (according to this specification), @Required SHALL be "true".
ResourceUpdate ? Deprecated in JDF 1.3	NMTOKENS	Specifies the capability to handle partial updates defined in ResourceUpdate elements. Values include: None – @ResourceUpdate is not supported. SHALL NOT be combined with any other value. JMFID – JMF Resource messages that reference ResourceUpdate elements that have been previously loaded to the device are accepted. PDLID – References from PDL data (e.g., PPML TicketRef elements that reference ResourceUpdate elements that have been previously loaded to the device are accepted).
ResourceUsage ? New in JDF 1.3	NMTOKEN	Resource/@ResourceUsage of the resource that is described by this DevCaps . Values include those from: ▶ ResourceUsage Attribute Values.

Table 10.7: DevCaps Element (Sheet 3 of 3)

NAME	DATA TYPE	DESCRIPTION
<i>TypeOccurrenceNum</i> ? New in JDF 1.2	IntegerRangeList	Specifies which occurrence(s) of the JDF node type that is specified either within the <i>DeviceCap</i> / <i>@Types</i> or by <i>DeviceCap</i> / <i>@TypeExpression</i> that the element that is defined by this <i>DevCaps</i> applies to. If not specified, this <i>DevCaps</i> element describes elements belonging to all JDF nodes or combined process steps with a matching type that are not defined by other <i>DevCaps</i> entries. Note: This is an index into the list of matching <i>@Type</i> values and not an index into the complete list specified by <i>@Types</i> or <i>@TypeExpression</i> . The first occurrence is "0", and the last occurrence is "-1", etc.
<i>Types</i> ? Deprecated in JDF 1.2	NMTOKENS	List of JDF node types that a <i>DevCaps</i> applies to. The value of <i>@Types</i> SHALL be a subset of <i>@Types</i> in <i>DeviceCap</i> . Values include those from: ▶ Chapter 6 Processes. Deprecation note: Starting with JDF 1.2, use <i>@TypeOccurrenceNum</i> .
<i>DevCap</i> * Modified in JDF 1.3	element	List of definitions of the accepted parameter space for resources and messages. The parameter spaces of multiple <i>DevCap</i> elements are combined as a superset of the individual <i>DevCap</i> elements. Only elements that are explicitly specified as <i>DevCap</i> elements within a <i>DevCaps</i> are supported. When a capabilities description is constructed using constraints, each <i>DevCaps</i> SHOULD contain only a single <i>DevCap</i> element (although a <i>DevCap</i> element MAY still contain multiple <i>DevCap</i> subelements). Exactly one of <i>@DevCapRef</i> or <i>DevCap</i> SHALL be specified, though if <i>DevCap</i> is specified, it MAY occur multiple times.
<i>Loc</i> * New in JDF 1.2	element	The localization(s) of the resource, message or <i>ResourceLink</i> name as described by this <i>DevCaps</i> element. See ▶ Section 10.2.5.1 Loc.

10.2.5.1 Loc

New in JDF 1.2

Each *Loc* element describes a localization for some value. Note that this subelement is used in many of the elements subordinate to *DeviceCap* elements.

Table 10.8: Loc Element

NAME	DATA TYPE	DESCRIPTION
<i>HelpText</i> ?	string	Localized text used for supplemental help for the value being localized. Note that this is the text often used for a pop-up window when help is requested.
<i>Lang</i> ?	language	The language code for this localization. If not specified, then it defaults to the value of the first language specified in the <i>@Lang</i> attribute of the <i>DeviceCap</i> element. Note that each language in a list of localizations (i.e., <i>Loc</i> *) SHALL be unique.
<i>ShortValue</i> ?	string	The short form of the localization. Defaults to the value of <i>@Value</i> . This value would be used when a small fixed field is REQUIRED for the name of the field (a PDA for example).

10.2.6 DevCap

New in JDF 1.1

The *DevCap* element describes the valid parameter space of a **JDF** resource, message or element that is consumed or produced by a device. The structure of the *DevCap* is identical to that of the **JDF** resource, message or element that it models. Individual attributes are replaced by the appropriate *State* elements. For more details on *State* elements, see ▶ Section 10.2.7 State. The *@Name* attribute of the *State* element SHALL match the attribute key that is described. If no *State* element exists for a given attribute, it is assumed to be unsupported. The restrictions of multiple attributes and elements are combined with a logical AND.

Subelements of resources are modeled by including nested *DevCap* with a *@ResourceUsage* attribute equal to the subelements tag name or *@ResourceUsage* if the subelement is a *FileSpec*. attributes of the *ResourceLink* belonging to the *Resource* (e.g., *@Transformation* or the various pipe control parameters can also be restricted).

Table 10.9: DevCap Element

NAME	DATA TYPE	DESCRIPTION
<i>Availability</i> ? New in JDF 1.2	enumeration	Specifies whether the feature described by this <i>DevCap</i> element is available on the device. Default value is from: parent <i>DevCaps</i> / <i>@Availability</i> or <i>DevCap</i> / <i>@Availability</i> . Allowed values are: <i>Installed</i> – The feature is installed on the device and is available for use. <i>Module</i> – The feature is provided by a module specified in <i>@ModuleRefs</i> . If and only if all modules that are listed in <i>@ModuleRefs</i> are available, the feature is available. New in JDF 1.3 <i>NotInstalled</i> – The feature has not been installed on the device. <i>NotLicensed</i> – The feature has been installed on the device but can not be used until licensed. <i>Disabled</i> – The feature is installed and licensed on the device but has been disabled.
<i>DevCapRefs</i> ? New in JDF 1.3	IDREFS	References to reusable <i>DevCap</i> elements that are located in <i>DeviceCap/DevCapPool</i> . A reference to a <i>DeviceCap/DevCapPool/DevCap</i> is equivalent to an inline <i>DevCap</i> in this <i>DevCap</i> . If both <i>@DevCapRefs</i> and <i>DevCap</i> elements exist, they specify the union of both.
<i>DevNS</i> = "http://www.CIP4.org/JDFSchema_1_1"	URI	Namespace of the element that is described by this <i>DevCap</i> .
<i>ID</i> ? New in JDF 1.3	ID	<i>@ID</i> of this <i>DevCap</i> . Used to reference a <i>DevCap</i> . <i>DevCap</i> / <i>@ID</i> SHALL be specified for all direct <i>DevCap</i> child elements in <i>DevCapPool</i> .
<i>MaxOccurs</i> = "1" Modified in JDF 1.2	integer	Maximum number of occurrences of the element described by this <i>DevCap</i> . In JDF 1.1 the "INF" value was defined as "unbounded".
<i>MinOccurs</i> = "1"	integer	Minimum number of occurrences of the element described by this <i>DevCap</i> .
<i>ModuleRefs</i> ? New in JDF 1.3	IDREFS	List of modules that are needed for this feature to be available. At least one entry SHALL be specified if <i>@Availability</i> = "Module". The list of modules is specified in <i>DeviceCap/ModulePool</i> .
<i>Name</i> ?	NMTOKEN	Name of the resource that is described. Default, if this <i>DevCap</i> is the direct child of a <i>DevCaps</i> element: the value of the parent <i>DevCaps</i> / <i>@Name</i> . <i>@Name</i> SHALL be specified for all direct <i>DevCap</i> child elements in <i>DevCapPool</i> or <i>DevCap</i> elements. Modification note: Starting with JDF 1.3 , <i>@Name</i> SHALL always specify the actual <i>Resource</i> name. Before JDF 1.3 <i>@ResourceUsage</i> of a resource was specified in this attribute. Values include those from: ▶ Chapter 10 Device Capabilities.
<i>ResourceUsage</i> ? New in JDF 1.3	NMTOKEN	<i>Resource</i> / <i>@ResourceUsage</i> of the resource that is described by this <i>DevCap</i> . Values include those from: ▶ ResourceUsage Attribute Values.
<i>DevCap</i> *	element	Definition of the accepted parameter space for the messages or resources subelements. If multiple <i>DevCap</i> elements with the same <i>@Name</i> exist, they describe individual subelements with different properties. The properties SHALL each be fulfilled by individual subelements of the element that is described by this <i>DevCap</i> . For instance, if two <i>DevCap</i> elements with the <i>@MinOccurs</i> = "1" are specified, the <i>JDF</i> element SHALL contain two elements with a node name = <i>DevCap</i> / <i>@Name</i> .
<i>Loc</i> * New in JDF 1.2	element	The localization(s) of the element name. See ▶ Section 10.2.5.1 Loc.
<i>State</i> *	element	Abstract State Elements that define the parameter space that is covered by the device. One <i>State</i> element SHALL be defined for each supported attribute or intent span element of the element that this <i>DevCap</i> defines that is not specified <i>DeviceCap</i> / <i>@GenericAttributes</i> .

10.2.7 State

New in JDF 1.1

► Figure 10-3: Abstract State element – a diagram of its structure shows all **State** elements.

Figure 10-3: Abstract State element – a diagram of its structure

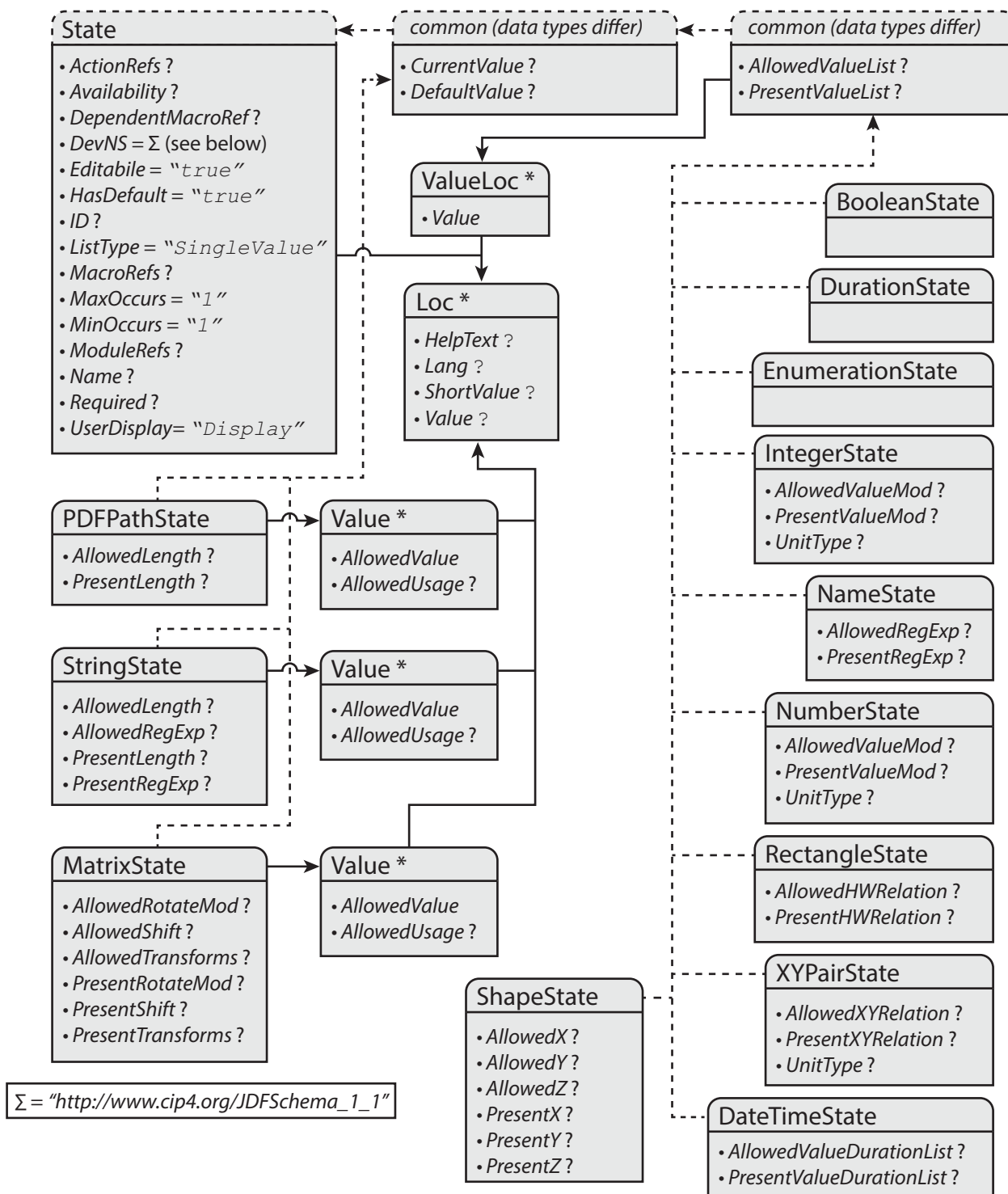

10.2.7.1 Abstract State Element

► Table 10.10 Abstract State Element describes the common, data type-independent parameters of all **State** elements. The **State** elements that contain no value restriction attributes (e.g., @AllowedValueList) or elements (e.g., ValueLoc) have no further restrictions other than the data type of their values. If value restrictions are specified in addition to a list of explicit values in @AllowedValueList, @CurrentValue, Value or ValueLoc, the **State** element describes the union of restrictions (i.e., the **State** element matches an attribute that matches either the explicit list or the additional restrictions).

Table 10.10: Abstract State Element (Sheet 1 of 2)

NAME	DATA TYPE	DESCRIPTION
ActionRefs ? New in JDF 1.2	IDREFS	Zero or more references to Action elements that operate on the parameter. All Action elements referenced SHALL evaluate to "false" for the value of the State element to be valid. Any Action elements referenced in @ActionRefs SHOULD be evaluated whenever the attribute described by this State element is manipulated or changed in order to catch any attributes that become invalid due to the manipulation.
Availability ? New in JDF 1.2	enumeration	Specifies whether the feature described by this State element is available on the device. Default behavior: the value specified or implied by the parent element. Allowed values are: Installed – The feature is installed on the device and is available for use. Module – The feature is provided by a module specified in @ModuleRefs . If and only if all modules that are listed in @ModuleRefs are available, is the feature available. New in JDF 1.3 NotInstalled – The feature has not been installed on the device. NotLicensed – The feature has been installed on the device but can not be used until licensed. Disabled – The feature is installed and licensed on the device, but has been disabled.
DependentMacroRef ? New in JDF 1.2	IDREF	A reference to a macro that conditionally modifies the @UserDisplay attribute of this State element. If present, this referenced macro SHALL be executed when the State/@UserDisplay is "Dependent" and the user interface is being initialized. It is RECOMMENDED that the macro referenced by @DependentMacroRef only change the value of @UserDisplay or @Editable attributes. For more information on macro definitions, see ▶ Section 10.2.10 MacroPool.
DevNS = "http://www.CIP4.org/JDFSchema_1_1"	URI	Namespace of the attribute or element that is described by this State element.
Editable = "true" New in JDF 1.2	boolean	When "true", the feature and its current value can be edited by the user. If "false", the user interface SHALL NOT allow user modification of the State element's current value.
HasDefault = "true"	boolean	A flag that describes whether the parameter has a default supplied by the device. If set, @DefaultValue SHALL be set.
ID ? New in JDF 1.2	ID	An identification value to allow external reference.
ListType = "SingleValue" New in JDF 1.2 Modified in JDF 1.3	enumeration	Specifies what type of list or object the State variable describes. Allowed value is from: ▶ ListType.
MacroRefs ? New in JDF 1.2	IDREFS	Zero or more references to macro elements that operate on the parameter. These macro elements set other State attribute values as appropriate. Any macro elements referenced in @MacroRefs SHALL be evaluated whenever the attribute described by this State element is manipulated or changed to affect any necessary changes to other attributes. The macro elements can change attributes such as the @CurrentValue attribute of a State or its @UserDisplay attribute. For more information on macro definitions, see ▶ Section 10.2.10 MacroPool.
MaxOccurs = "1" New in JDF 1.2	integer	Maximum number of elements in the list described by this State (e.g., the maximum number of integers in an integer list). If @MaxOccurs is not "1", the State element refers to a list or a range of list values (e.g., a NameState will allow a list of NMTOKENS).

Table 10.10: Abstract State Element (Sheet 2 of 2)

NAME	DATA TYPE	DESCRIPTION
<i>MinOccurs</i> = "1" New in JDF 1.2	integer	Minimum number of elements in the list described by this State . If <i>@MinOccurs</i> is not "1", the State element refers to a list or a range of list values (e.g., a NameState will allow a list of NMTOKENS).
<i>ModuleRefs</i> ? New in JDF 1.3	IDREFS	List of modules that are needed for this feature to be available. At least one entry SHALL be specified if <i>@Availability</i> = "Module". The list of modules is specified in DeviceCap/ModulePool .
<i>Name</i> ?	NMTOKEN	Name of the attribute that is described by this State . If <i>@Name</i> is omitted this State describes the element's text (i.e., the text between the XML start and end tag).
<i>Required</i> ? New in JDF 1.2 Deprecated in JDF 1.6	boolean	If "true", then the attribute or span element described by this State element is REQUIRED to be present in a JDF or JMF (as appropriate) submitted to the device. Note that this does not override the cardinality specified by the JDF specification where the specification requires the element to be specified. Deprecation note: Starting with JDF 1.6, replaced by <i>@Cardinality</i> .
<i>Span</i> ? New in JDF 1.1A Deprecated in JDF 1.2	boolean	A flag that describes whether the parameter is an intent span data type. For example a State element describing an XYPairSpan would have <i>@DataType</i> = "XYPairState" and <i>@Span</i> = "true". Replaced with <i>@ListType</i> = "Span" in JDF 1.2 and beyond.
<i>UserDisplay</i> = "Display" New in JDF 1.2	enumeration	Indicates whether the feature SHALL be displayed in user interfaces. Allowed values are: Display – The feature SHALL be displayed. Hide – The feature SHALL NOT to be displayed. Dependent – The feature SHALL be conditionally displayed depending on the action specified by the macro referenced by <i>@DependentMacroRef</i> . Note: This action is only taken when the user interface is first initialized.
<i>Loc</i> * New in JDF 1.2	element	The localization(s) of the <i>@Name</i> of the attribute that is described by this State element. See ▶ Section 10.2.5.1 Loc.

10.2.7.2 State Elements

The following types of **State** elements are defined:

Table 10.11: List of State Elements (Sheet 1 of 2)

NAME	DESCRIPTION
BooleanState	Describes a set of boolean values.
DateTimeState New in JDF 1.2	Describes a set of dateTime values.
DurationState New in JDF 1.2	Describes a set of duration values.
EnumerationState	Describes a set of enumeration values.
IntegerState	Describes a numerical range of integer values.
MatrixState	Describes a range of matrices. Generally used to define valid orientations of Component resources.
NameState	Describes a set of NMTOKEN values.
NumberState	Describes a numerical range of values.
PDFPathState New in JDF 1.2	Describes a set of PDFPaths.

Table 10.11: List of State Elements (Sheet 2 of 2)

NAME	DESCRIPTION
RectangleState New in JDF 1.2	Describes a set of 4 value rectangle values.
ShapeState	Describes a set of 3 value shape values.
StringState	Describes a set of string values.
XYPairState	Describes a set of XYPair values.

10.2.7.2.1 BooleanState

New in JDF 1.1

This **State** subelement is used to describe ranges of boolean values. It inherits from the abstract **State** element described above.

Table 10.12: BooleanState Element

NAME	DATA TYPE	DESCRIPTION
AllowedValueList ? New in JDF 1.1A	enumerations	A list of all legal values. Allowed values are: true false
CurrentValue ?	boolean	Current value for the current running job set in the device.
DefaultValue ?	boolean	Default value if not specified in a submitted JDF. @DefaultValue SHALL be specified if @HasDefault = "true".
PresentValueList ? New in JDF 1.1A	enumerations	A list of all supported values that can be chosen without operator intervention. Default value is from: @AllowedValueList. Allowed values are: true false
ValueLoc * New in JDF 1.2	element	Localization(s) of "true" and/or "false" values. See ▶ Section 10.2.7.2.1.1 ValueLoc.

10.2.7.2.1.1 ValueLoc

New in JDF 1.2

Each **ValueLoc** element describes one or more localizations for an attribute value. Note that the **ValueLoc** element occurs in the definition of all **State** elements except **MatrixState**, **PDFPathState** and **StringState**.

Table 10.13: ValueLoc Element

NAME	DATA TYPE	DESCRIPTION
Value	string	The attribute value to be localized. If the data type of the allowed value is not string (e.g., if ValueLoc is used in the context of a MatrixState), @Value SHALL be an instance of the appropriate data type.
Loc *	element	The localization(s) of the attribute value. See ▶ Section 10.2.5.1 Loc.

10.2.7.2.2 DateTimeState

New in JDF 1.2

This **State** subelement is used to describe ranges of dateTime values. It inherits from the abstract **State** element described above.

Table 10.14: DateTimeState Element

NAME	DATA TYPE	DESCRIPTION
<i>AllowedValueDurationList</i> ?	DurationRangeList	List of inclusive minimum and maximum allowed values relative to the current system time.
<i>AllowedValueList</i> ?	DateTimeRangeList	A list of all supported values.
<i>CurrentValue</i> ?	dateTime	Current value for the current running job set in the device.
<i>DefaultValue</i> ?	dateTime	Default value if not specified in a submitted JDF. <i>@DefaultValue</i> SHALL be specified if <i>@HasDefault</i> = "true".
<i>PresentValueDurationList</i> ?	DurationRangeList	List of inclusive minimum and maximum allowed values that can be chosen without operator intervention relative to the current system time. If not specified, the value of <i>@AllowedValueDurationList</i> is applied.
<i>PresentValueList</i> ?	DateTimeRangeList	Inclusive minimum and maximum allowed value that can be chosen without operator intervention. If not specified, the value of <i>@AllowedValueList</i> is applied.
<i>ValueLoc</i> *	element	Localization(s) of specific dates. See ▶ Section 10.2.7.2.1.1 ValueLoc.

10.2.7.2.3 DurationState

New in JDF 1.2

This **State** subelement is used to describe ranges of duration values. It inherits from the abstract **State** element described above.

Table 10.15: DurationState Element

NAME	DATA TYPE	DESCRIPTION
<i>AllowedValueList</i> ?	DurationRangeList	A list of all supported values.
<i>CurrentValue</i> ?	duration	Current value for the current running job set in the device.
<i>DefaultValue</i> ?	duration	Default value if not specified in a submitted JDF. <i>@DefaultValue</i> SHALL be specified if <i>@HasDefault</i> = "true".
<i>PresentValueList</i> ?	DurationRangeList	Inclusive minimum and maximum allowed value that can be chosen without operator intervention. If not specified, the value of <i>@AllowedValueList</i> is applied.
<i>ValueLoc</i> *	element	Localization(s) of specific durations. See ▶ Section 10.2.7.2.1.1 ValueLoc.

10.2.7.2.4 EnumerationState

New in JDF 1.1

This **State** subelement is used to describe ranges of enumerative values. It inherits from the abstract **State** element described above. It is identical to the **NameState** element except that it describes a closed list of enumeration values.

Table 10.16: EnumerationState Element (Sheet 1 of 2)

NAME	DATA TYPE	DESCRIPTION
<i>AllowedValueList</i> ?	enumerations	A list of all supported values. The values specified in <i>@AllowedValueList</i> SHALL be a subset of the enumeration specified by <i>@Name</i> . If not specified, all enumerations defined by the XML schema are valid. In order to enable capabilities to be specified without access to the JDF XML schema, it is strongly RECOMMENDED to specify <i>@AllowedValueList</i> , even when the entire range of schema-valid values is supported.

Table 10.16: EnumerationState Element (Sheet 2 of 2)

NAME	DATA TYPE	DESCRIPTION
<i>CurrentValue</i> ?	enumeration	Current value for the current running job set in the device. <i>@CurrentValue</i> SHALL match the enumeration defined in the resource.
<i>DefaultValue</i> ?	enumeration	Default value if not specified in a submitted JDF . <i>@DefaultValue</i> SHALL match the enumeration defined in the resource, and SHALL be specified if <i>@HasDefault</i> = "true".
<i>PresentValueList</i> ?	enumerations	A list of values that can be chosen without operator intervention. <i>@PresentValueList</i> SHALL match the enumeration defined in the resource. Default value is from: <i>@AllowedValueList</i> .
<i>ValueLoc</i> * New in JDF 1.2	element	Localizations of the enumerations listed in <i>@AllowedValueList</i> and <i>@PresentValueList</i> . See ▶ Section 10.2.7.2.1.1 ValueLoc.

10.2.7.2.5 IntegerState

New in JDF 1.1

This **State** subelement is used to describe ranges of integer values. It inherits from the abstract **State** element described above.

Table 10.17: IntegerState Element (Sheet 1 of 2)

NAME	DATA TYPE	DESCRIPTION
<i>AllowedValueList</i> ? Modified in JDF 1.2	IntegerRangeList	A list of all supported values.
<i>AllowedValueMax</i> ? Deprecated in JDF 1.2	integer	Inclusive maximum allowed value. Replaced by <i>@AllowedValueList</i> in JDF 1.2 and beyond.
<i>AllowedValueMin</i> ? Deprecated in JDF 1.2	integer	Inclusive minimum allowed value. Replaced by <i>@AllowedValueList</i> in JDF 1.2 and beyond.
<i>AllowedValueMod</i> ? New in JDF 1.2	XYPair	X defines the modulo and Y the offset of the allowed value. In other words, if <i>@AllowedValueMod</i> = "10 2", only the values ... -8,2,12,22 ... are allowed. If not specified, all values in the range are valid. If $((N\%X) - Y = 0)$ then N is a valid value. Note: "Modulo" is the remainder of an integer division. For example: $4 \text{ mod } 3 = 4 - 3 = 1$; $17 \text{ mod } 3 = 17 - 5 * 3 = 2$; and $3 \text{ mod } 3 = 3 - 3 = 0$.
<i>CurrentValue</i> ?	integer	Current value for the current running job set in the device.
<i>DefaultValue</i> ?	integer	Default value if not specified in a submitted JDF . <i>@DefaultValue</i> SHALL be specified if <i>@HasDefault</i> = "true".
<i>PresentValueList</i> ? Modified in JDF 1.2	IntegerRangeList	A list of values that can be chosen without operator intervention. If not specified, the value of <i>@AllowedValueList</i> is applied.
<i>PresentValueMax</i> ? Deprecated in JDF 1.2	integer	Inclusive maximum allowed value that can be chosen without operator intervention. If not specified, the value of <i>@AllowedValueMax</i> is applied. Replaced by <i>@PresentValueList</i> in JDF 1.2 and beyond.
<i>PresentValueMin</i> ? Deprecated in JDF 1.2	integer	Inclusive minimum allowed value that can be chosen without operator intervention. If not specified, the value of <i>@AllowedValueMin</i> is applied. Replaced by <i>@PresentValueList</i> in JDF 1.2 and beyond.
<i>PresentValueMod</i> ? New in JDF 1.2	XYPair	X defines the modulo and Y the offset of the present value. In other words, if <i>@AllowedValueMod</i> = "10 2", only the values ... -8,2,12,22 ... are allowed. If not specified, the value of <i>@AllowedValueMod</i> is applied. If $((N\%X) - Y = 0)$ then N is a valid value.

Table 10.17: IntegerState Element (Sheet 2 of 2)

NAME	DATA TYPE	DESCRIPTION
<p><i>UnitType</i> ? New in JDF 1.2</p>	NMTOKEN	<p>Specifies the unit type that this State element represents. Used to enable an application to localize the representation of the units. @<i>UnitType</i> SHOULD be specified if the IntegerState represents a value that has units. User interfaces might not display correctly if @<i>UnitType</i> is not specified for attributes with units.</p> <p>Values include:</p> <p>Angle – The attribute is defined in degrees.</p> <p>AngularVelocity – Rotations / minute.</p> <p>Area – Area in square meters (m²).</p> <p>Currency – The local currency.</p> <p>Length – In points (1/72 inch).</p> <p>LengthMu – Length in microns (used for paper thickness).</p> <p>LineScreen – The lines per inch (lpi) for conventionally screened halftone, screened grayscale and screened monotone bitmap images.</p> <p>PaperWeight – In grams per square meter (g/m²).</p> <p>Percentage – A percentage value.</p> <p>Pressure – In Pascals.</p> <p>Resolution – The dots per inch (dpi) for print output and bitmap image (e.g., TIFF or BMP) file resolution.</p> <p>ScreenResolution – The pixels per inch (ppi) for screen display (e.g., softproof display and user interface display), scanner capture settings and digital camera settings.</p> <p>SpotResolution – For imaging devices such as filmsetters, platesetters and proofers, the fundamental imaging unit (e.g., one “on” laser or imaging-head imaged unit). Note that many imaging devices construct dots from multiple imaging spots, so dpi and spots per inch (spi) are not equivalent.</p> <p>Temperature – Temperature in degrees Centigrade.</p> <p>Velocity – Defined as meters/hour.</p> <p>Weight – Weight in grams.</p>
<p><i>ValueLoc</i> * New in JDF 1.2</p>	element	<p>Localization(s) of specific values. See ▶ Section 10.2.7.2.1.1 ValueLoc.</p>

10.2.7.2.6 MatrixState

New in JDF 1.1

This **State** subelement is used to describe ranges of matrix values. It inherits from the abstract **State** element described above. It is primarily intended to specify orientations and manipulation capabilities of **PhysicalResources** (e.g., in finishing devices).

Table 10.18: MatrixState Element (Sheet 1 of 2)

NAME	DATA TYPE	DESCRIPTION
<p><i>AllowedRotateMod</i> ? New in JDF 1.2</p>	double	<p>Allowed modulo of the allowed rotations and offset in degrees.</p> <p>Values include:</p> <p>360 – No rotation</p> <p>90 – Any orthogonal rotation.</p> <p>0 – Any rotation is allowed.</p>
<p><i>AllowedShift</i> ? New in JDF 1.2</p>	DoubleList	<p>Minimum and maximum allowed shift of the matrix. If not specified, any shift is valid. If @<i>AllowedTransforms</i> is specified, the implied shift defined in ▶ Table 2.4 Matrices and Orientation values for describing the orientation of a Component is subtracted from @<i>AllowedShift</i>, thus all in-place rotations have an implied @<i>AllowedShift</i> value of "0 0 0 0". (No shift = "0 0 0 0".) The first pair of numbers is the XY pair that defines the minimum shift, and the second pair is the XY pair that defines the maximum shift.</p>
<p><i>AllowedTransforms</i> ? New in JDF 1.2</p>	enumerations	<p>List of valid orthogonal transformations of the matrix. Any of the eight pre-defined transforms for PhysicalResources as defined in ▶ Table 2.4 Matrices and Orientation values for describing the orientation of a Component.</p> <p>Allowed values are from: ▶ Orientation.</p>
<p><i>CurrentValue</i> ?</p>	matrix	<p>Current value for the current running job set in the device.</p>

Table 10.18: MatrixState Element (Sheet 2 of 2)

NAME	DATA TYPE	DESCRIPTION
<i>DefaultValue</i> ?	matrix	Default value if not specified in a submitted JDF . <i>@DefaultValue</i> SHALL be specified if <i>@HasDefault</i> = "true".
<i>PresentRotateMod</i> ? New in JDF 1.2	double	Present modulo of the allowed rotations and offset in degrees that can be chosen without operator intervention. If not specified, the value of <i>@AllowedRotateMod</i> is applied. Values include: 360 – No rotation is allowed. 90 – Any orthogonal rotation. 0 – Any rotation is allowed.
<i>PresentShift</i> ? New in JDF 1.2	DoubleList	If <i>@PresentTransforms</i> is specified, the implied shift defined in ▶ Table 2.4 Matrices and Orientation values for describing the orientation of a Component is subtracted from <i>@PresentShift</i> , thus all in-place rotations have an implied <i>@PresentShift</i> value of "0 0 0 0". If not specified, the value of <i>@AllowedShift</i> is applied.
<i>PresentTransforms</i> ? New in JDF 1.2	enumerations	Any of the eight predefined transforms for <i>PhysicalResources</i> as defined in ▶ Table 2.4 Matrices and Orientation values for describing the orientation of a Component. If not specified, the value of <i>@AllowedTransforms</i> is applied. Allowed values are from: ▶ Orientation.
<i>Value</i> *	element	A list legal values. See ▶ Section 10.2.7.2.6.1 Value.

10.2.7.2.6.1 Value

Table 10.19: MatrixState/Value Element

NAME	DATA TYPE	DESCRIPTION
<i>AllowedValue</i>	matrix	A legal value for a matrix variable.
<i>PresentValue</i> ? Deprecated in JDF 1.2	matrix	A legal value for a matrix variable that can be chosen without operator intervention. If not specified, the value of <i>@AllowedValue</i> is applied. In JDF 1.2 and beyond, use <i>@ValueUsage</i> .
<i>ValueUsage</i> ? New in JDF 1.2	enumeration	Defines whether the value defined in <i>@AllowedValue</i> means "Present", "Allowed" or both. Default behavior: valid for both "Present" and "Allowed". Allowed values are: Present – Present configuration is supported. Allowed – Allowed configuration is supported.
<i>Loc</i> * New in JDF 1.2	element	The localization(s) of the string defined in <i>@AllowedValue</i> . See ▶ Section 10.2.5.1 Loc.

10.2.7.2.7 NameState

New in JDF 1.1

This **State** subelement is used to describe ranges of NMTOKEN values. It inherits from the abstract **State** element described above.

Table 10.20: NameState Element (Sheet 1 of 2)

NAME	DATA TYPE	DESCRIPTION
<i>AllowedRegExp</i> ? New in JDF 1.2	regExp	Regular expression that limits the allowed values.
<i>AllowedValueList</i> ?	NMTOKENS	A list legal values.
<i>CurrentValue</i> ?	NMTOKEN	Current value for the current running job set in the device.

Table 10.20: NameState Element (Sheet 2 of 2)

NAME	DATA TYPE	DESCRIPTION
<i>DefaultValue</i> ? New in JDF 1.1	NMTOKEN	Default value if not specified in a submitted JDF . <i>@DefaultValue</i> SHALL be specified if <i>@HasDefault</i> = "true".
<i>PresentRegExp</i> ? New in JDF 1.2	regExp	Regular expression that limits the values that can be chosen without operator intervention. If not specified, the value of <i>@AllowedRegExp</i> is applied.
<i>PresentValueList</i> ?	NMTOKENS	A list of values that can be chosen without operator intervention. If not specified, the value of <i>@AllowedValueList</i> is applied.
<i>ValueLoc</i> * New in JDF 1.2	element	Localization(s) of the NMTOKENS listed in <i>@AllowedValueList</i> or <i>@PresentValueList</i> or implied by <i>@AllowedRegExp</i> or <i>@PresentRegExp</i> . See ▶ Section 10.2.7.2.1.1 ValueLoc.

10.2.7.2.8 NumberState

New in JDF 1.1

This **State** subelement is used to describe ranges of double values. It inherits from the abstract **State** element described above.

Table 10.21: NumberState Element (Sheet 1 of 2)

NAME	DATA TYPE	DESCRIPTION
<i>AllowedValueList</i> ? Modified in JDF 1.2	DoubleRangeList	A list of supported values.
<i>AllowedValueMax</i> ? Deprecated in JDF 1.2	double	Inclusive maximum allowed value. Replaced by <i>@AllowedValueList</i> in JDF 1.2 and beyond.
<i>AllowedValueMin</i> ? Deprecated in JDF 1.2	double	Inclusive minimum allowed value. Replaced by <i>@AllowedValueList</i> in JDF 1.2 and beyond.
<i>AllowedValueMod</i> ? New in JDF 1.2	XYPair	X defines the modulo and Y the offset of the allowed value. In other words, if <i>@AllowedValueMod</i> = "10 2", only the values ... -8,2,12,22 ... are allowed. If not specified, all values in the range are valid. If $((N \% X) - Y = 0)$ then N is a valid value. Note: "Modulo" is the remainder of an integer division. For example: $4 \bmod 3 = 4 - 3 = 1$; $17 \bmod 3 = 17 - 5 * 3 = 2$; and $3 \bmod 3 = 3 - 3 = 0$.
<i>CurrentValue</i> ?	double	Current value for the current running job set in the device.
<i>DefaultValue</i> ?	double	Default value if not specified in a submitted JDF . <i>@DefaultValue</i> SHALL be specified if <i>@HasDefault</i> = "true".
<i>PresentValueList</i> ? Modified in JDF 1.2	DoubleRangeList	A list of values that can be chosen without operator intervention. If not specified, the value of <i>@AllowedValueList</i> is applied.
<i>PresentValueMax</i> ? Deprecated in JDF 1.2	double	Inclusive maximum allowed value that can be chosen without operator intervention. If not specified, the value of <i>@AllowedValueMax</i> is applied. Replaced by <i>@PresentValueList</i> in JDF 1.2 and beyond.
<i>PresentValueMin</i> ? Deprecated in JDF 1.2	double	Inclusive minimum allowed value that can be chosen without operator intervention. If not specified, the value of <i>@AllowedValueMin</i> is applied. Replaced by <i>@PresentValueList</i> in JDF 1.2 and beyond.
<i>PresentValueMod</i> ? New in JDF 1.2	XYPair	X defines the modulo and Y the offset of the allowed value. In other words, if <i>@AllowedValueMod</i> = "10 2", only the values ... -8,2,12,22 ... are allowed. If not specified, the value of <i>@AllowedValueMod</i> is applied. If $((N \% X) - Y = 0)$ then N is a valid value.

Table 10.21: NumberState Element (Sheet 2 of 2)

NAME	DATA TYPE	DESCRIPTION
<i>UnitType</i> ? New in JDF 1.2	NMTOKEN	Specifies the unit type that this State element represents. Used to enable an application to localize the representation of the units. @ <i>UnitType</i> SHALL be specified if the NumberState represents a value that has units. NumberState has the values as IntegerState plus a few more: Values include: CMYKColor – Four values representing a CMYK color. LabColor – Three values representing a Lab color. sRGBColor – Three values representing a sRGB color. Values include those from: ▶ Table 10.17 IntegerState Element.
<i>ValueLoc</i> * New in JDF 1.2	element	Localization(s) of specific values. See ▶ Section 10.2.7.2.1.1 ValueLoc.

10.2.7.2.9 PDFPathState

New in JDF 1.2

This **State** subelement is used to describe ranges of PDF paths. It inherits from the abstract **State** element described above.

Table 10.22: PDFPathState Element

NAME	DATA TYPE	DESCRIPTION
<i>AllowedLength</i> ?	IntegerRange	Inclusive minimum and maximum length of valid PDF path in multi-byte characters. Note that this is the length in characters and not in bytes of the internal encoding of an application.
<i>CurrentValue</i> ?	PDFPath	Current value for the current running job set in the device.
<i>DefaultValue</i> ?	PDFPath	Default value if not specified in a submitted JDF . @ <i>DefaultValue</i> SHALL be specified if @ <i>HasDefault</i> = "true".
<i>PresentLength</i> ?	IntegerRange	Inclusive minimum and maximum length of valid PDF path in characters that can be chosen without operator intervention. If not specified, the value of @ <i>AllowedLength</i> is applied.
<i>Value</i> *	element	The localization(s) of the PDF path defined in @ <i>AllowedValue</i> . See ▶ Section 10.2.7.2.9.1 Value.

10.2.7.2.9.1 Value

Table 10.23: PDFPathState/Value Element

NAME	DATA TYPE	DESCRIPTION
<i>AllowedValue</i>	PDFPath	A legal value for a matrix variable.
<i>ValueUsage</i> ?	enumeration	Defines whether the value defined in @ <i>AllowedValue</i> means "Present", "Allowed" or both. Default behavior: valid for both "Present" and "Allowed". Allowed values are: Present – Present configuration is supported. Allowed – Allowed configuration is supported.
<i>Loc</i> *	element	The localization(s) of the string defined in @ <i>AllowedValue</i> . See ▶ Section 10.2.5.1 Loc.

10.2.7.2.10 RectangleState

New in JDF 1.2

This **State** subelement is used to describe ranges of rectangle values. It inherits from the abstract **State** element described above.

Table 10.24: RectangleState Element

NAME	DATA TYPE	DESCRIPTION
AllowedHWRelation ?	enumeration	Allowed relative value of width (X) vs. Height (Y). Allowed value is from: ▶ XYRelation.
AllowedValueList ?	RectangleRangeList	A list of ranges of allowed values that can be chosen.
CurrentValue ?	rectangle	Current value for the current running job set in the device.
DefaultValue ?	rectangle	Default value if not specified in a submitted JDF . @DefaultValue SHALL be specified if @HasDefault = "true".
PresentHWRelation ?	enumeration	Allowed relative value of width (X) vs. Height (Y). If not specified, the value of @AllowedHWRelation is applied. Allowed value is from: ▶ XYRelation.
PresentValueList ?	RectangleRangeList	A list of ranges of values that can be chosen without operator intervention. If not specified, the value of @AllowedValueList is applied.
ValueLoc *	element	A list of supported values. The ValueLoc / @Value attribute SHALL be a representation of a rectangle. This can also be used to localize (or provide names for) specific rectangles. See ▶ Section 10.2.7.2.1.1 ValueLoc.

10.2.7.2.11 ShapeState

New in JDF 1.1

This **State** subelement is used to describe ranges of shape values. It inherits from the abstract **State** element described above.

Table 10.25: ShapeState Element (Sheet 1 of 2)

NAME	DATA TYPE	DESCRIPTION
AllowedValueList ? Modified in JDF 1.2	ShapeRangeList	A list of values that can be chosen.
AllowedValueMax ? Deprecated in JDF 1.2	shape	Inclusive maximum allowed value. Replaced by @AllowedValueList in JDF 1.2 and beyond.
AllowedValueMin ? Deprecated in JDF 1.2	shape	Inclusive minimum allowed value. Replaced by @AllowedValueList in JDF 1.2 and beyond.
AllowedX ? New in JDF 1.2	DoubleRangeList	Allowed X-axis of the @Shape .
AllowedY ? New in JDF 1.2	DoubleRangeList	Allowed Y-axis of the @Shape .
AllowedZ ? New in JDF 1.2	DoubleRangeList	Allowed Z-axis of the @Shape .
CurrentValue ?	shape	Current value for the current running job set in the device.
DefaultValue ?	shape	Default value if not specified in a submitted JDF . @DefaultValue SHALL be specified if @HasDefault = "true".
PresentValueList ? Modified in JDF 1.2	ShapeRangeList	A list of values that can be chosen without operator intervention. If not specified, the value of @AllowedValueList is applied.
PresentValueMax ? Deprecated in JDF 1.2	shape	Inclusive maximum allowed value that can be chosen without operator intervention. If not specified, the value of @AllowedValueMax is applied. Replaced by @AllowedValueList in JDF 1.2 and beyond.

Table 10.25: ShapeState Element (Sheet 2 of 2)

NAME	DATA TYPE	DESCRIPTION
<i>PresentValueMin</i> ? Deprecated in JDF 1.2	shape	Inclusive minimum allowed value that can be chosen without operator intervention. If not specified, the value of <i>@AllowedValueMin</i> is applied. Replaced by <i>@AllowedValueList</i> in JDF 1.2 and beyond.
<i>PresentX</i> ? New in JDF 1.2	Double-RangeList	Present X-axis of the <i>@Shape</i> that can be chosen without operator intervention. If not specified, the value of <i>@AllowedX</i> is applied.
<i>PresentY</i> ? New in JDF 1.2	Double-RangeList	Present Y-axis of the <i>@Shape</i> that can be chosen without operator intervention. If not specified, the value of <i>@AllowedY</i> is applied.
<i>PresentZ</i> ? New in JDF 1.2	Double-RangeList	Present Z-axis of the <i>@Shape</i> that can be chosen without operator intervention. If not specified, the value of <i>@AllowedZ</i> is applied.
<i>ValueLoc</i> * New in JDF 1.2	element	A list of supported shapes. See ▶ Section 10.2.7.2.1.1 ValueLoc.

10.2.7.2.12 StringState

New in JDF 1.1

This **State** subelement is used to describe ranges of string values. It inherits from the abstract **State** element described above.

Table 10.26: StringState Element

NAME	DATA TYPE	DESCRIPTION
<i>AllowedLength</i> ? New in JDF 1.2	IntegerRange	Inclusive minimum and maximum length of valid string in multi-byte characters. Note that this is the length in characters, and not in bytes of the internal encoding of an application. For instance, the length of the string "Grün" is 4 and not 6 (UTF-8 with a terminating 0 and a double byte "ü").
<i>AllowedRegExp</i> ? New in JDF 1.2	regExp	Regular expression that limits the allowed values.
<i>CurrentValue</i> ?	string	Current value for the current running job set in the device.
<i>DefaultValue</i> ?	string	Default value if not specified in a submitted JDF . <i>@DefaultValue</i> SHALL be specified if <i>@HasDefault</i> = "true".
<i>PresentLength</i> ? New in JDF 1.2	IntegerRange	Inclusive minimum and maximum length of valid string in characters that can be chosen without operator intervention. If not specified, the value of <i>@AllowedLength</i> is applied.
<i>PresentRegExp</i> ? New in JDF 1.2	regExp	Regular expression that limits the present values that can be chosen without operator intervention. If not specified, the value of <i>@AllowedRegExp</i> is applied.
<i>Value</i> * Modified in JDF 1.2	element	A list legal values. See ▶ Section 10.2.7.2.12.1 Value.

10.2.7.2.12.1 Value

New in JDF 1.1

Table 10.27: StringState/Value Element (Sheet 1 of 2)

NAME	DATA TYPE	DESCRIPTION
<i>AllowedValue</i>	string	A legal value for a string variable.
<i>PresentValue</i> ? Deprecated in JDF 1.2	string	A legal value for a string variable that can be chosen without operator intervention. If not specified, the value of <i>@AllowedValue</i> is applied. In JDF 1.2 and beyond, use <i>@ValueUsage</i> .

Table 10.27: StringState/Value Element (Sheet 2 of 2)

NAME	DATA TYPE	DESCRIPTION
ValueUsage ? New in JDF 1.2	enumeration	Defines whether the value defined in @AllowedValue means "Present", "Allowed" or both. Default behavior: valid for both "Present" and "Allowed". Allowed values are: Present – Present configuration is supported. Allowed – Allowed configuration is supported.
Loc * New in JDF 1.2	element	The localization(s) of the string defined in @AllowedValue . See ▶ Section 10.2.5.1 Loc.

10.2.7.2.13 XYPairState

New in JDF 1.1

This **State** subelement is used to describe ranges of XYPair values. It inherits from the abstract **State** element described above.

Table 10.28: XYPairState Element

NAME	DATA TYPE	DESCRIPTION
AllowedValueList ? Modified in JDF 1.2	XYPair-RangeList	A list of values that can be chosen.
AllowedValueMax ? Deprecated in JDF 1.2	XYPair	Inclusive maximum allowed value. Replaced with @AllowedValueList in JDF 1.2 and beyond.
AllowedValueMin ? Deprecated in JDF 1.2	XYPair	Inclusive minimum allowed value. Replaced with @AllowedValueList in JDF 1.2 and beyond.
AllowedXYRelation ? New in JDF 1.2	enumeration	Relative value of X vs. Y. Allowed value is from: ▶ XYRelation.
CurrentValue ?	XYPair	Current value for the current running job set in the device.
DefaultValue ?	XYPair	Default value if not specified in a submitted JDF . @DefaultValue SHALL be specified if @HasDefault = "true".
PresentValueList ? Modified in JDF 1.2	XYPair-RangeList	A list of values that can be chosen without operator intervention. If not specified, the value of @AllowedValueList is applied.
PresentValueMax ? Deprecated in JDF 1.2	XYPair	Inclusive maximum allowed value that can be chosen without operator intervention. If not specified, the value of @AllowedValueMax is applied. Replaced with @PresentValueList in JDF 1.2 and beyond.
PresentValueMin ? Deprecated in JDF 1.2	XYPair	Inclusive minimum allowed value that can be chosen without operator intervention. If not specified, the value of @AllowedValueMin is applied. Replaced with @PresentValueList in JDF 1.2 and beyond.
PresentXYRelation ? New in JDF 1.2	enumeration	Relative value of X vs. Y that can be chosen without operator intervention. If not specified, the value of @AllowedXYRelation is applied. Allowed value is from: ▶ XYRelation.
UnitType ? New in JDF 1.2	NMTOKEN	Specifies the unit type that this State element represents. Used to enable an application to localize the representation of the units. @UnitType SHALL be specified if the IntegerState represents a value that has units. Values include those from: ▶ Table 10.17 IntegerState Element.
ValueLoc * New in JDF 1.2	element	A list of supported shapes. See ▶ Section 10.2.7.2.1.1 ValueLoc.

10.2.8 DisplayGroupPool

New in JDF 1.2

DEVICE CAPABILITIES

The **DisplayGroupPool** element declares set(s) of related features that are intended to be displayed as a group in user interfaces. These declarations are references to individual features declared in **State** elements.

Table 10.29: DisplayGroupPool Element

NAME	DATA TYPE	DESCRIPTION
DisplayGroup *	element	Declares a set of references to State elements that are intended to be displayed as a group in user interfaces.

Example 10.1: DisplayGroupPool

In this example, a single **DisplayGroup** is specified. This **DisplayGroup** declares that the **State** attributes with @ID's "btd", "cmp", "mag", "colorspace" and "outputres" are all to be grouped together in any user interface. The English string "ScanningParameters" is associated with this **DisplayGroup**, though no explicit assumptions are made about how to display this group of attributes. The **DisplayGroup** element merely states that there is a user-significant relationship between the attributes.

```
<Device Class="Implementation" ID="Link0003" Status="Available">
  <DeviceCap>
    <DisplayGroupPool>
      <DisplayGroup rRefs="btd cmp mag colorspace outputres">
        <Loc HelpText="Parameters for scanning configuration" Lang="en"
          Value="ScanningParameters"/>
      </DisplayGroup>
    </DisplayGroupPool>
  </DeviceCap>
</Device>
```

10.2.8.1 DisplayGroup

Each **DisplayGroup** element declares a group of features that are intended to be displayed together in user interfaces.

Table 10.30: DisplayGroup Element

NAME	DATA TYPE	DESCRIPTION
rRefs	IDREFS	References to State elements. See ▶ Section 10.2.7 State for details of the State element.
Loc *	element	Localized strings describing the DisplayGroup . See ▶ Section 10.2.5.1 Loc.

10.2.9 FeaturePool

New in JDF 1.2

Modified in JDF 1.5

The **FeaturePool** element describes message or resource subelements that represent composite features for user manipulation when describing capabilities. These features typically do not directly represent any **JDF** resources or parameters, but rather trigger macros that manipulate related sets of parameters. For more information on macro definitions, see ▶ Section 10.2.10 MacroPool.

These features can be mapped to ▶ NamedFeatures (see ▶ NamedFeature in ▶ Table 1.4 Glossary). A feature from ▶ NamedFeatures is selected by specifying a **GeneralID**[@DataType="NamedFeature"] where **GeneralID**/@IDUsage maps to @Name and **GeneralID**/@IDValue is restricted by the **State** elements in the **FeaturePool**.that matches entries from **FeaturePool/State**/@Name and **FeaturePool/State**/@AllowedValueList.

Table 10.31: FeaturePool Element

NAME	DATA TYPE	DESCRIPTION
State *	element	State elements that define the accepted parameter space for the messages or resources subelements. These State Subelements are identical in form to other State elements, but typically are only "macro" features that control other features through macro elements. For more information on macro definitions, see ▶ Section 10.2.10 MacroPool. For details of the State element, see ▶ Section 10.2.7 State.

Example 10.2: FeaturePool

In this example, *ScanMode* is a feature that doesn't map directly to any **JDF** resource or attribute, but provides a “shell” feature that allows users to control a set of **JDF** resources and/or attributes to indicate a common or preferred grouping based on the user’s desired task. The actual corresponding **JDF** resource attribute values are determined and set by the *ScanModeMacro* **macro** that is called when the *ScanMode* feature is manipulated.

```
<Device Class="Implementation" ID="Link0003" Status="Available">
  <DeviceCap>
    <FeaturePool>
      <EnumerationState
        AllowedValueList="Mono ColorTransparency Photo"
        HasDefault="false" ID="sm" MacroRefs="ScanModeMac"
        Name="ScanMode" UserDisplay="Display"/>
      </FeaturePool>
    </DeviceCap>
  </Device>
```

10.2.10 MacroPool

New in JDF 1.2

The **MacroPool** element is used to contain descriptions of macro expressions. Each macro declares a set of conditional operations that are used to change **State** element attribute values.

Table 10.32: MacroPool Element

NAME	DATA TYPE	DESCRIPTION
macro *	element	A list of independent macros.

Figure 10-4: macro element – a diagram of its structure

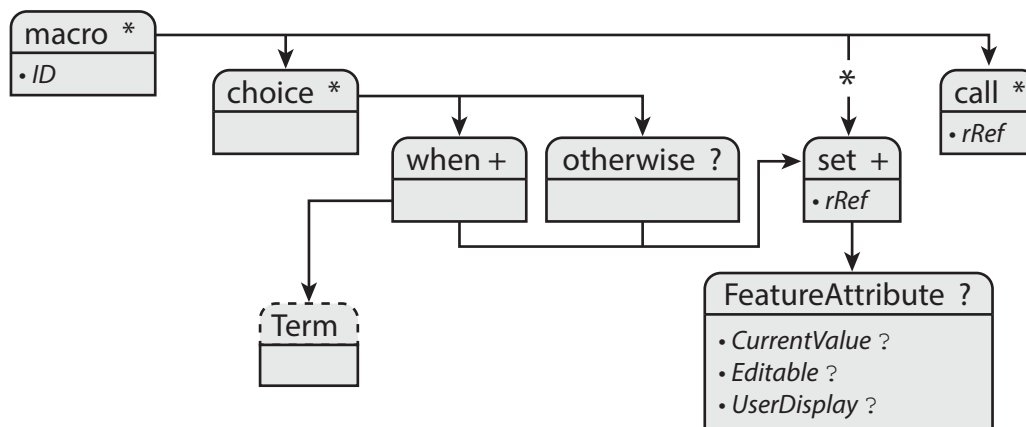

10.2.10.1 macro

New in JDF 1.2

The **macro** subelement is used to contain a set of conditional operations that are used to change **State** element attribute values. Each **macro** contains one or more of the following elements:

- **choice** — Declares one or more **when** statements, each of which contains a boolean expression (as defined in ▶ Section 10.2.13 Term) and a **set** element. When the expression evaluates to "true", the action specified in the **set** element SHALL be performed. If no evaluation in any **when** element in a **choice** evaluates to "true", the action(s) specified in the **otherwise** element SHALL be performed.
- **set** — sets the condition of one or more **State** element attributes.
- **call** — calls another **macro** to be executed.

When executing a **macro**, consumers SHALL execute **choice**, **set** and **call** elements in the order in which they are specified in the actual XML document. Note that the ordering provided in the actual capabilities description SHOULD be honored. The following shows the logical layout of the **macro** subelement:

Table 10.33: macro Element

NAME	DATA TYPE	DESCRIPTION
<i>ID</i>	ID	Unique identifier of a <i>macro</i> element. This @ <i>ID</i> is used to refer to the <i>macro</i> element.
<i>choice</i> *	element	A set of conditional operations that set (or not) feature values. At least one of <i>choice</i> , <i>set</i> or <i>call</i> SHALL be specified in <i>macro</i> .
<i>set</i> *	element	An element that sets one or more <i>State</i> attribute values. At least one of <i>choice</i> , <i>set</i> or <i>call</i> SHALL be specified in <i>macro</i> .
<i>call</i> *	element	An element that calls another <i>macro</i> , allowing for <i>macro</i> reuse and chaining. At least one of <i>choice</i> , <i>set</i> or <i>call</i> SHALL be specified in <i>macro</i> .

10.2.10.2 choice

The *choice* subelement is used to contain expressions that declare conditional operations that can cause *State* element attribute values to be changed. The *choice* includes one or more *when* statements that are evaluated in order, each of which contains a boolean expression (as defined in ▶ Section 10.2.13 Term) and a *set* element. When the expression evaluates to "true", the action specified in the *set* element SHALL be performed and no further *when* statements are evaluated. If no evaluation in any *when* element in a *choice* evaluates to "true", the action(s) specified in the *otherwise* element SHALL be performed.

Table 10.34: choice Element

NAME	DATA TYPE	DESCRIPTION
<i>when</i> +	element	A set of conditional operations that set (or not) feature values.
<i>otherwise</i> ?	element	An element that sets one or more <i>State</i> element attribute values if none of the <i>when</i> expressions evaluate to "true".

10.2.10.3 otherwise

The *otherwise* subelement sets one or more feature values if none of the *when* expressions in a *choice* element evaluate to "true".

Table 10.35: otherwise Element

NAME	DATA TYPE	DESCRIPTION
<i>set</i> +	element	An element that sets one or more feature values.

10.2.10.4 when

The *when* subelement is used to contain expressions that declare conditional operations to enforce sets of feature behaviors. The *when* element includes a boolean expression (as defined in ▶ Section 10.2.13 Term) and a *set* element. When the *Term* evaluates to "true", the action specified in the *set* element SHALL be performed.

Table 10.36: when Element

NAME	DATA TYPE	DESCRIPTION
<i>Term</i>	element	A boolean expression that evaluates a set of feature values.
<i>set</i> +	element	An element that sets one or more feature values.

10.2.10.5 set

The *set* subelement sets one or more *State* element attribute values.

Table 10.37: set Element

NAME	DATA TYPE	DESCRIPTION
<i>rRef</i>	IDREF	Reference to a State element referring to the feature value to set
FeatureAttribute ?	element	Specifies one or more attributes within the State element that are to have their value changed (along with the value they change to).

10.2.10.6 FeatureAttribute

FeatureAttribute specifies one or more attributes of a **State** element that are to have their value changed. The following attributes can be changed:

Table 10.38: FeatureAttribute Element

NAME	DATA TYPE	DESCRIPTION
<i>CurrentValue</i> ?	string	The value to change the <i>@CurrentValue</i> attribute of the State element to. Note that the mapping of the string to the actual data type of the State element SHALL be performed by the application processing the capabilities.
<i>Editable</i> ?	boolean	When "true", the feature and its current value can be edited by the user. If "false", the user interface SHALL NOT allow user modification of the current value of the State element.
<i>UserDisplay</i> ?	enumeration	Indicates under which conditions the feature SHALL be displayed in user interfaces. Allowed values are from: State/@UserDisplay.

10.2.10.7 call

The **call** subelement is used to call other **macro** elements, effectively using them as macro "templates".

Table 10.39: call Element

NAME	DATA TYPE	DESCRIPTION
<i>rRef</i>	IDREF	Reference to a macro .

10.2.11 Performance

New in JDF 1.1

The **Performance** element describes speed as the capability to consume or produce a **JDF** resource.

Table 10.40: Performance Element (Sheet 1 of 2)

NAME	DATA TYPE	DESCRIPTION
<i>AverageAmount</i> ?	double	Average amount produced/consumed per hour assuming an average job.
<i>AverageCleanup</i> ?	duration	Average time needed to clean the device after a job.
<i>AverageSetup</i> ?	duration	Average time needed to setup the device before a job.
<i>DevCapsRef</i> ? New in JDF 1.2	IDREF	Reference to the DevCaps element that describes the resource whose performance is specified by this Performance element.
<i>MaxAmount</i> ?	double	Maximum amount produced/consumed per hour, assuming an ideal job. The default value of "0" translates to the value of <i>@AverageAmount</i> .
<i>MaxCleanup</i> ?	duration	Maximum time needed to clean the device after a job, assuming a worst case job. Defaults to <i>@AverageCleanup</i> .
<i>MaxSetup</i> ?	duration	Maximum time needed to setup the device before a job, assuming a worst case job. Defaults to <i>@AverageSetup</i> .

Table 10.40: Performance Element (Sheet 2 of 2)

NAME	DATA TYPE	DESCRIPTION
<i>MinAmount</i> ?	double	Minimum amount produced/consumed per hour, assuming a worst case job. Defaults to <i>@AverageAmount</i> .
<i>MinCleanup</i> ?	duration	Minimum time needed to clean the device after a job, assuming an ideal job. Defaults to <i>@AverageCleanup</i> .
<i>MinSetup</i> ?	duration	Minimum time needed to setup the device before a job, assuming an ideal job. Defaults to <i>@AverageSetup</i> .
<i>Name</i> ? Deprecated in JDF 1.2	NMTOKEN	Name of the input resource type that is processed by the device (e.g., <i>Media</i> , <i>Ink</i> , <i>RunList</i>). Deprecation note: Starting with JDF 1.2, use <i>@DevCapsRef</i> .
<i>Unit</i> ?	NMTOKEN	Unit of measure of resource consumption per hour. Default value is from: ▶ Units.

10.2.12 TestPool

New in JDF 1.2

The **TestPool** subelement is used to contain boolean expressions that are used to describe “templates” for use in **Action** elements.

Table 10.41: TestPool Element

NAME	DATA TYPE	DESCRIPTION
Test *	element	A list of independent Test elements.

10.2.12.1 Test

The **Test** subelement is used to contain boolean expressions that are for use only when referenced by another **Test** or **Action** and are not evaluated independently. Its purpose is to simplify the description of other **Test** elements and **macro** elements by representing a commonly used boolean expression.

Table 10.42: Test Element

NAME	DATA TYPE	DESCRIPTION
<i>ID</i>	ID	Unique identifier of a Test element. This ID is used to refer to the Test element.
<i>Term</i>	element	Any element derived from an abstract Term (e.g., “not”, “and” or one of the explicit Evaluation elements).

10.2.13 Term

10.2.13.1 Abstract Term

▶ Figure 10-5: Abstract Term element – a diagram of its structure shows the **Abstract Term** and all **Term** elements

Figure 10-5: Abstract Term element – a diagram of its structure

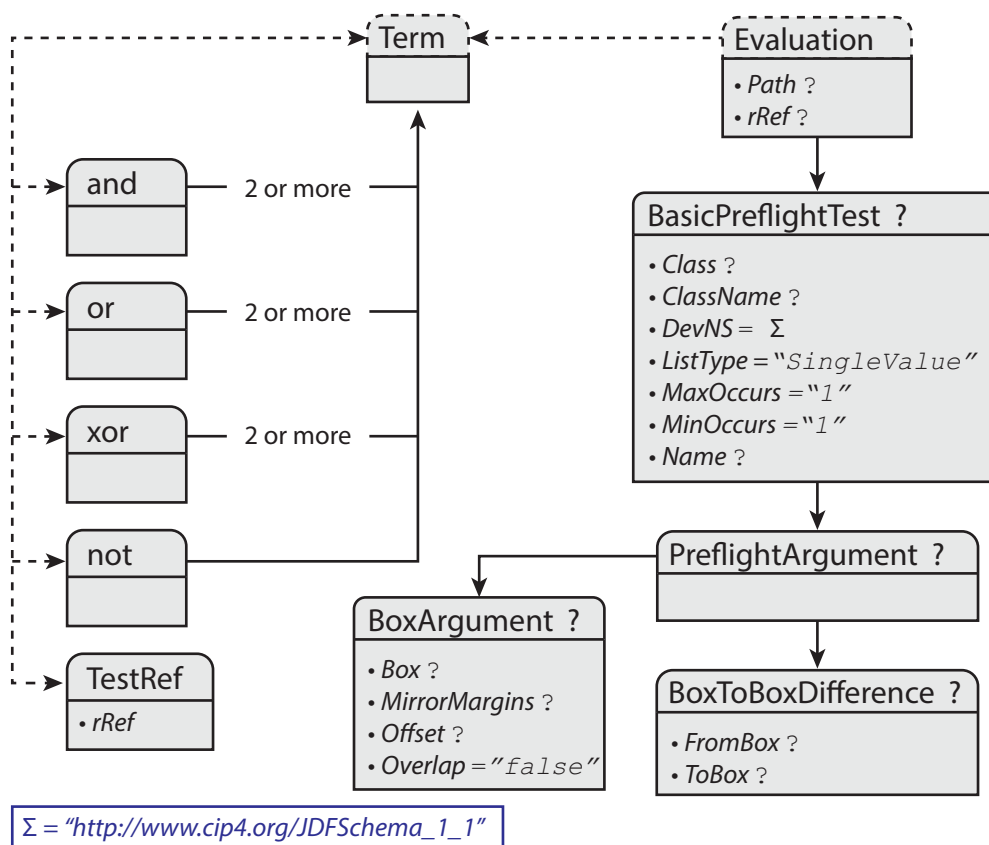

10.2.13.2 Term Elements

The **Term** element serves as the basis for all constraint expressions and conditional macro expressions. It describes a (potentially) nested boolean expression that evaluates as a whole to either "true" or "false". This expression is then used inside constraint or **macro** elements to determine proper action given the evaluation of the **Term**. **Term** elements are composed of boolean combinations of elements in ▶ Table 10.43 List of Term Elements. The **Term** elements that are boolean operators MAY be nested. They are used both in device capabilities and preflighting context.

Note: In the actual **JDF** schema, several abstract element definitions are used to create an appropriate inheritance structure. Rather than reproduce this here, only the actual non-Abstract elements that will appear in **JDF** files will be described

Table 10.43: List of Term Elements

NAME	PAGE	DESCRIPTION
and	page 680	Boolean AND operator.
not	page 681	Boolean negation.
or	page 680	Boolean OR operator.
xor	page 680	Boolean exclusive or (XOR) operator.
TestRef	page 681	Reference to a constraint Test element to be evaluated as a nested boolean expression inside a larger expression.
Evaluation	page 682	Elements, which evaluate a JDF State attribute value to create a simple boolean expression (e.g., "Is the value of @BitDepth equal to 8?"). Each XXXExpression element is derived from the Abstract Evaluation element.

Example 10.3: ActionPool and TestPool

Term is an abstract element, so it will never appear in a **JDF** document. In this "ctcmp" constraint example, the **Term** is represented by the **and** element. Since the **Term** element itself is abstract, what will actually appear in constraints will be boolean expressions. In this example, the logic is, "We can not use CCITT compression if the bit depth is not 1 bit." The check for compression type uses an **EnumerationEvaluation** element, which evaluates an **EnumerationState** value

DEVICE CAPABILITIES

against "CCITTFaxEncode". If the value of the **EnumerationState** element referred to by "cmp" = "CCITTFaxEncode", the **EnumerationEvaluation** evaluates as "true". The check for "btd" is accomplished through a @TestRef to the "is1bit" constraint. The **and** and **not** elements behave according to the standard semantics for boolean combinatorial logic.

```
<Device Class="Implementation" ID="Link0003" Status="Available">
  <DeviceCap>
    <ActionPool>
      <Action ID="MyAction" TestRef="ctcmp">
        <Loc
          HelpText="Only select CCITTFaxEncoding for 1 bit documents"
          Lang="en" ShortValue="Ouch!" Value="CCITTFaxEncoding not supported on grayscale images"/>
        </Action>
      </ActionPool>
    <TestPool>
      <Test ID="ctcmp">
        <!-- Can't CCITT compress anything but 1 bit grayscale -->
        <and>
          <not>
            <TestRef rRef="is1bit"/>
          </not>
          <EnumerationEvaluation ValueList="CCITTFaxEncode" rRef="cmp"/>
        </and>
      </Test>
      <Test ID="is1bit">
        <IntegerEvaluation ValueList="1" rRef="btd"/>
      </Test>
    </TestPool>
  </DeviceCap>
</Device>
```

10.2.13.3 and

The **and** element evaluates two or more **Term** elements to determine if, as a set, they evaluate to "true" when combined in a boolean "and" function.

Table 10.44: and Element

NAME	DATA TYPE	DESCRIPTION
Term	element	Any element derived from an abstract Term .
Term +	element	Any element derived from an abstract Term .

10.2.13.4 or

The **or** element evaluates two or more **Term** elements to determine if, as a set, they evaluate to "true" when combined in a boolean "or" function.

Table 10.45: or Element

NAME	DATA TYPE	DESCRIPTION
Term	element	Any element derived from an abstract Term .
Term +	element	Any element derived from an abstract Term .

10.2.13.5 xor

The **xor** element evaluates two or more **Term** elements to determine if, as a set, they evaluate to "true" when combined in a boolean "xor" function. For more than two arguments, exactly one **Term** SHALL evaluate to "true" for the **xor** to evaluate to "true". Note that this is different from the mathematical behavior of "xor".

Table 10.46: xor Element

NAME	DATA TYPE	DESCRIPTION
Term	element	Any element derived from an abstract Term .
Term +	element	Any element derived from an abstract Term .

10.2.13.6 not

The **not** element inverts the boolean state of a **Term**.

Table 10.47: not Element

NAME	DATA TYPE	DESCRIPTION
Term	element	Any element derived from an abstract Term .

10.2.13.7 TestRef

The **TestRef** element refers to another constraint that SHALL be evaluated as part of the parent constraint.

Table 10.48: TestRef Element

NAME	DATA TYPE	DESCRIPTION
rRef	IDREF	Reference to a Test to be evaluated as a nested boolean expression inside a larger expression.

10.2.13.8 Evaluation

► Figure 10-6: Abstract Evaluation Element – a diagram of its structure shows all *Evaluation* elements.

Figure 10-6: Abstract Evaluation Element – a diagram of its structure

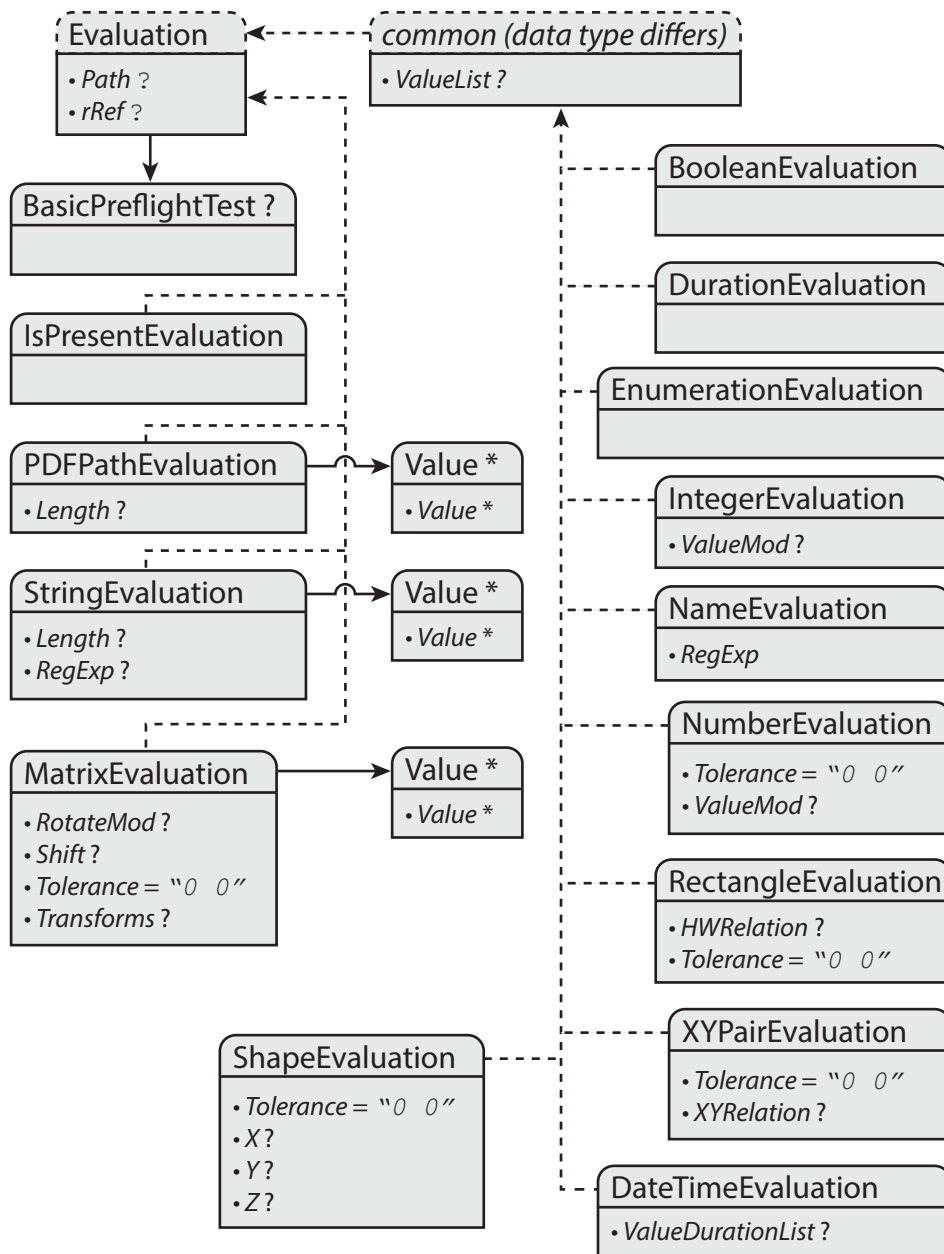

10.2.13.8.1 Abstract Evaluation

The following table describes the common, data type-independent parameters of all *Evaluation* elements.

Table 10.49: Abstract Evaluation Element (Sheet 1 of 2)

NAME	DATA TYPE	DESCRIPTION
<i>Path</i> ? New in JDF 1.4	XPath	When present, describes an XPath within the file where the value to be evaluated may be found. Constraint: Exactly one of @ <i>Path</i> , @ <i>rRef</i> or <i>BasicPreflightTest</i> SHALL be specified.
<i>rRef</i> ? Modified in JDF 1.4	IDREF	A reference to <i>State</i> , <i>DevCap</i> , <i>DevCaps</i> or <i>Module</i> elements when used in the context of device capability descriptions. Constraint: Exactly one of @ <i>Path</i> , @ <i>rRef</i> or <i>BasicPreflightTest</i> SHALL be specified. Modification note: Starting with JDF 1.4, <i>DevCap</i> and <i>DevCaps</i> can also be referenced and @ <i>Path</i> added to the all constraints in this table.

Table 10.49: Abstract Evaluation Element (Sheet 2 of 2)

NAME	DATA TYPE	DESCRIPTION
BasicPreflightTest ?	element	<p>Definition of the preflight basic test to which the Evaluation refers. BasicPreflightTest is only valid when Evaluation elements are used in the context of preflighting. The Evaluation elements in capability descriptions SHALL reference the appropriate State element using @rRef. For details of the BasicPreflightTest, see ▶ Section 8.111 PreflightParams.</p> <p>Constraint: Exactly one of @Path, @rRef or BasicPreflightTest SHALL be specified.</p>

10.2.13.8.2 Evaluation Elements

[Evaluation](#) elements map generalized tests against a condition to form a true or false boolean state that can be evaluated using the boolean logic defined below.

Table 10.50: List of Evaluation Elements

NAME	PAGE	DESCRIPTION
BooleanEvaluation	page 684	Describes operations on a set of boolean values.
DateTimeEvaluation	page 684	Describes operations on a set of dateTime values.
DurationEvaluation	page 685	Describes operations on a set of duration values.
EnumerationEvaluation	page 685	Describes operations on a set of enumeration values.
IntegerEvaluation	page 685	Describes operations on a numerical range of integer values.
IsPresentEvaluation	page 685	Checks for the existence of a tag, element or feature.
MatrixEvaluation	page 686	Describes operations on a range of matrices. Generally used to define valid orientations of Component resources.
NameEvaluation	page 686	Describes operations on a set of NMTOKEN values
NumberEvaluation	page 686	Describes operations on a numerical range of values.
PDFPathEvaluation	page 687	Describes operations on PDFPath.
RectangleEvaluation	page 687	Describes operations on a set of four-value rectangle values.
ShapeEvaluation	page 687	Describes operations on a set of three-value shape values.
StringEvaluation	page 688	Describes operations on a set of string values.
XYPairEvaluation	page 688	Describes operations on a set of XYPair values.

Mapping of Evaluation Element to State Element

When used in a device capabilities context, the [Evaluation](#) elements map to the [State](#) elements (i.e., [BooleanState](#), [IntegerState](#), etc.). These elements each declare individual **JDF** attributes for a device capabilities description. The [Evaluation](#) elements are instances of [Term](#) elements that compare the value of a given [State](#) attribute against a condition to form a true or false boolean statement. The form of the condition depends on the type of the [Evaluation-State](#) element pairing — different types of pairings need different condition declarations, depending on the structure of the logic and the data type of the [Evaluation](#) and [State](#) elements.

When used in a preflighting context, [Evaluation](#) elements map named preflight tests against a condition to form a true or false boolean statement.

Table 10.51: Mapping of Evaluation Element to State Element

NAME	CORRESPONDING STATE ELEMENT	DESCRIPTION
<i>BooleanEvaluation</i>	<i>BooleanState</i>	Describes operations on a set of boolean values.
<i>DateTimeEvaluation</i>	<i>DateTimeState</i>	Describes operations on a set of dateTime values.
<i>DurationEvaluation</i>	<i>DurationState</i>	Describes operations on a set of duration values.
<i>EnumerationEvaluation</i>	<i>EnumerationState</i>	Describes operations on a set of enumeration values.
<i>IntegerEvaluation</i>	<i>IntegerState</i>	Describes operations on a numerical range of integer values.
<i>IsPresentEvaluation</i>	<i>State</i> (all, IsPresent-State (ElementState))	Checks for the existence of a tag, element or feature.
<i>MatrixEvaluation</i>	<i>MatrixState</i>	Describes operations on a range of matrices. Generally used to define valid orientations of Component resources.
<i>NameEvaluation</i>	<i>NameState</i>	Describes operations on a set of NMTOKEN values
<i>NumberEvaluation</i>	<i>NumberState</i>	Describes operations on a numerical range of values.
<i>PDFPathEvaluation</i>	<i>PDFPathState</i>	Describes operations on PDFPath.
<i>RectangleEvaluation</i>	<i>RectangleState</i>	Describes operations on a set of four-value rectangle values.
<i>ShapeEvaluation</i>	<i>ShapeState</i>	Describes operations on a set of three-value shape values.
<i>StringEvaluation</i>	<i>StringState</i>	Describes operations on a set of string values.
<i>XYPairEvaluation</i>	<i>XYPairState</i>	Describes operations on a set of XYPair values.

10.2.13.8.2.1 BooleanEvaluation

The *BooleanEvaluation* element declares a boolean value for comparison in an expression to a *BooleanState* element in constraints. It inherits from the *Abstract Evaluation* element described above.

Table 10.52: BooleanEvaluation Element

NAME	DATA TYPE	DESCRIPTION
<i>ValueList</i> ?	enumerations	A list of all supported values. Allowed values are: true false

10.2.13.8.2.2 DateTimeEvaluation

The *DateTimeEvaluation* element declares a boolean value for comparison in an expression to a *DateTimeState* element in constraints. It inherits from the *Abstract Evaluation* element described above.

Table 10.53: DateTimeEvaluation Element (Sheet 1 of 2)

NAME	DATA TYPE	DESCRIPTION
<i>ValueDurationList</i> ?	DurationRange-List	List of inclusive minimum and maximum allowed values relative to the current system time.

Table 10.53: DateTimeEvaluation Element (Sheet 2 of 2)

NAME	DATA TYPE	DESCRIPTION
<i>ValueList</i> ?	DateTimeRangeList	A list of all supported values.

10.2.13.8.2.3 DurationEvaluation

The *DurationEvaluation* element declares a boolean value for comparison in an expression to a *DurationState* element in constraints. It inherits from the *Abstract Evaluation* element described above.

Table 10.54: DurationEvaluation Element

NAME	DATA TYPE	DESCRIPTION
<i>ValueList</i> ?	DurationRangeList	A list of all supported values.

10.2.13.8.2.4 EnumerationEvaluation

The *EnumerationEvaluation* element declares an enumeration value for comparison in an expression to an *EnumerationState* element in constraints. It inherits from the *Abstract Evaluation* element described above.

Table 10.55: EnumerationEvaluation Element

NAME	DATA TYPE	DESCRIPTION
<i>ValueList</i> ?	enumerations	A list of all potential supported values. If not specified all enumerations defined by the XML schema are valid. In order to enable capabilities to be specified without access to the JDF XML schema, it is strongly RECOMMENDED to specify <i>@ValueList</i> , even when the entire range of schema-valid values is supported.

10.2.13.8.2.5 IntegerEvaluation

The *IntegerEvaluation* element declares an integer value for comparison in an expression to a *IntegerState* element in constraints.

Table 10.56: IntegerEvaluation Element

NAME	DATA TYPE	DESCRIPTION
<i>ValueList</i> ?	IntegerRangeList	A list of all supported values.
<i>ValueMod</i> ?	XYPair	X defines the modulo and Y the offset of the allowed value. In other words, if <i>@AllowedValueMod = "10 2"</i> , only the values ... -8,2,12,22 ... are allowed. If not specified all values in the range are valid. If $((N\%X)-Y = 0)$ then N is a valid value. Note: "Modulo" is the remainder of an integer division. For example: $4 \text{ mod } 3 = 4 - 3 = 1$; $17 \text{ mod } 3 = 17 - 5 * 3 = 2$; and $3 \text{ mod } 3 = 3 - 3 = 0$.

10.2.13.8.2.6 IsPresentEvaluation

The *IsPresentEvaluation* element checks for the existence of a tag, module or feature. It inherits from the *Abstract Evaluation* element described above and has no additional attributes. *IsPresentEvaluation*/*@rRef* MAY reference a *DevCap* element in order to test for the existence of an element.

IsPresentEvaluation/*@rRef* MAY reference a *DevCaps* element in order to test for the existence of a resource.

Table 10.57: IsPresentEvaluation Element

NAME	DATA TYPE	DESCRIPTION

10.2.13.8.2.7 MatrixEvaluation

The **MatrixEvaluation** element declares a matrix value for comparison in an expression to a **MatrixState** element in constraints. It inherits from the **Abstract Evaluation** element described above.

Table 10.58: MatrixEvaluation Element

NAME	DATA TYPE	DESCRIPTION
<i>RotateMod</i> ?	double	Allowed modulo of the allowed rotations and offset in degrees. Note: Although this seems counter-intuitive and contrary to the convention set in JDF coordinate systems, the application of @RotateMod in practice will involve subtracting values by the value of the @RotateMod . Hence, any number is reduced by "0" and is unaffected by the subtraction. Values include: 360 – No rotation is allowed. 90 – Any orthogonal rotation. 0 – Interpreted to mean that any rotation is allowed.
<i>Shift</i> ?	DoubleList	If @Transforms is specified, the implied shift defined in ▶ Table 2.4 Matrices and Orientation values for describing the orientation of a Component is subtracted from @Shift , thus all in-place rotations have an implied shift value of "0 0 0".
<i>Tolerance</i> = "0 0"	XYPair	The tolerance between the real and actual values that are defined as equal. Used to account for rounding errors and such. The first value is a positive value representing the negative tolerance, and the second value represents the positive tolerance. The tolerance applies to all of the matrix values.
<i>Transforms</i> ?	enumerations	Any of the eight predefined transforms for PhysicalResources as defined in ▶ Table 2.4 Matrices and Orientation values for describing the orientation of a Component. Allowed values are from: ▶ Orientation.
<i>Value</i> *	element	A list supported values. The Value / @Value attribute SHALL be a representation of a matrix. See ▶ Section 10.2.13.8.2.7.1 Value.

10.2.13.8.2.7.1 Value

Table 10.59: MatrixEvaluation/Value Element

NAME	DATA TYPE	DESCRIPTION
<i>Value</i>	matrix	A supported value for a matrix variable.

10.2.13.8.2.8 NameEvaluation

The **NameEvaluation** element declares a NMTOKEN value for comparison in an expression to a **NameState** element in constraints. It inherits from the **Abstract Evaluation** element described above.

Table 10.60: NameEvaluation Element

NAME	DATA TYPE	DESCRIPTION
<i>RegExp</i>	regExp	Regular expression that limits the allowed values.
<i>ValueList</i> ?	NMTOKENS	A list of supported values.

10.2.13.8.2.9 NumberEvaluation

The **NumberEvaluation** element declares a number value for comparison in an expression to a **NumberState** element in constraints. It inherits from the **Abstract Evaluation** element described above.

Table 10.61: NumberEvaluation Element

NAME	DATA TYPE	DESCRIPTION
<i>Tolerance</i> = "0 0"	XYPair	The tolerance between the real and actual values that are defined as equal. Used to account for rounding errors and such. The first value is a positive value representing the negative tolerance, and the second represents the positive tolerance.
<i>ValueList</i> ?	DoubleRangeList	A list of supported values.
<i>ValueMod</i> ?	XYPair	X defines the modulo and Y the offset of the allowed value. In other words, if <i>@AllowedValueMod</i> = "10 2", only the values ... -8,2,12,22 ... are allowed. If not specified all values in the range are valid. If $((N\%X)-Y = 0)$ then N is a valid value. Note: "Modulo" is the remainder of an integer division. For example: $4 \bmod 3 = 4 - 3 = 1$; $17 \bmod 3 = 17 - 5 * 3 = 2$; and $3 \bmod 3 = 3 - 3 = 0$.

10.2.13.8.2.10 PDFPathEvaluation

The *PDFPathEvaluation* element declares a PDF path value for comparison in an expression to a *PDFPathState* element in constraints. It inherits from the *Abstract Evaluation* element described above.

Table 10.62: PDFPathEvaluation Element

NAME	DATA TYPE	DESCRIPTION
<i>Length</i> ?	IntegerRange	Inclusive minimum and maximum length of valid PDF path in characters.
<i>Value</i> *	element	PDF path values for comparison in an expression to a <i>PDFPathState</i> element. See ▶ Section 10.2.13.8.2.10.1 Value .

10.2.13.8.2.10.1 Value

Table 10.63: PDFPathEvaluation/Value Element

NAME	DATA TYPE	DESCRIPTION
<i>Value</i>	PDFPath	A supported value for a PDF path attribute.

10.2.13.8.2.11 RectangleEvaluation

The *RectangleEvaluation* element declares a boolean value for comparison in an expression to a *RectangleState* element in constraints. It inherits from the *Abstract Evaluation* element described above.

Table 10.64: RectangleEvaluation Element

NAME	DATA TYPE	DESCRIPTION
<i>HWRRelation</i> ?	enumeration	Allowed relative value of width (X) versus height (Y). Allowed value is from: ▶ XYRelation .
<i>Tolerance</i> = "0 0"	XYPair	The tolerance between the real and actual values that are defined as equal. Used to account for rounding errors and such. The first value is a positive value representing the negative tolerance, and the second represents the positive tolerance. The tolerance applies to both sides of the rectangle.
<i>ValueList</i> ?	RectangleRangeList	A list of ranges of allowed values that can be chosen.

10.2.13.8.2.12 ShapeEvaluation

The *ShapeEvaluation* element declares a shape value for comparison in an expression to a *ShapeState* element in constraints. It inherits from the *Abstract Evaluation* element described above.

Table 10.65: ShapeEvaluation Element

NAME	DATA TYPE	DESCRIPTION
<i>Tolerance</i> = "0 0"	XYPair	The tolerance between the real and actual values that are defined as equal. Used to account for rounding errors and such. The first value is a positive value representing the negative tolerance, and the second represents the positive tolerance. The tolerance applies to all values tested.
<i>ValueList</i> ?	ShapeRange-List	A list of ranges of values that can be chosen.
<i>X</i> ?	Dou-bleRangeList	Allowed X-axis of the <i>Shape</i> .
<i>Y</i> ?	Dou-bleRangeList	Allowed Y-axis of the <i>Shape</i> .
<i>Z</i> ?	Dou-bleRangeList	Allowed Z-axis of the <i>Shape</i> .

10.2.13.8.2.13 StringEvaluation

The *StringEvaluation* element declares a string value for comparison in an expression to a *StringState* element in constraints. It inherits from the *Abstract Evaluation* element described above.

Table 10.66: StringEvaluation Element

NAME	DATA TYPE	DESCRIPTION
<i>Length</i> ?	IntegerRange	Inclusive minimum and maximum length of valid string in characters. Note that this is the length in characters, and not in bytes of the internal encoding of an application. For instance, the length of the string "Grün" is 4 and not 6 (UTF-8 with a terminating 0 and a double byte "ü").
<i>RegExp</i> ?	regExp	Regular expression that limits the allowed values.
<i>Value</i> *	element	A string value for comparison in an expression to a <i>StringEvaluation</i> element. See ▶ Section 10.2.13.8.2.13.1 Value.

10.2.13.8.2.13.1 Value

Table 10.67: StringEvaluation/Value Element

NAME	DATA TYPE	DESCRIPTION
<i>Value</i>	string	A supported value for a string attribute.

10.2.13.8.2.14 XYPairEvaluation

The *XYPairEvaluation* element declares a XYPair value for comparison in an expression to a *XYPairState* element in constraints. It inherits from the *Abstract Evaluation* element described above.

Table 10.68: XYPairEvaluation Element (Sheet 1 of 2)

NAME	DATA TYPE	DESCRIPTION
<i>Tolerance</i> = "0 0"	XYPair	The tolerance between the real and actual values that are defined as equal. Used to account for rounding errors and such. The first value is a positive value representing the negative tolerance, and the second represents the positive tolerance. These tolerance values apply to both the X and Y values of the evaluation being performed.
<i>ValueList</i> ?	XYPair-RangeList	A list of values that can be chosen.

Table 10.68: XYPairEvaluation Element (Sheet 2 of 2)

NAME	DATA TYPE	DESCRIPTION
XYRelation ?	enumeration	Relative value of X vs. Y. Allowed value is from: ▶ XYRelation.

10.2.14 Examples of Device Capabilities

New in JDF 1.1

All of the examples in this section are based on a simple definition of a scanner. The **JMF** based hand shaking is also illustrated. **NodeInfo**, **ExposedMedia** and **ScanParams** are restricted.

10.2.14.1 Device Description of a Scanner

This first example shows the general structure and provides an example of user interface localization (the query requests localization for the French language, and localizations are returned for the **ScanParams** resource).

Example 10.4: KnownDevices Query for a Scanner

```
<JMF MaxVersion="1.6" SenderID="Controller"
  TimeStamp="2005-04-05T16:45:43+02:00" Version="1.6"
  xmlns="http://www.CIP4.org/JDFSchema_1_1" xmlns:xsi="http://www.w3.org/2001/XMLSchema-instance">
  <Query ID="DeviceQuery" Type="KnownDevices" xsi:type="QueryKnownDevices">
    <DeviceFilter DeviceDetails="Capability" Localization="fre"/>
  </Query>
</JMF>
```

Example 10.5: KnownDevices Response for a Scanner

```
<JMF MaxVersion="1.6" SenderID="Scanner"
  TimeStamp="2005-06-05T16:45:43+02:00" Version="1.6"
  xmlns="http://www.CIP4.org/JDFSchema_1_1" xmlns:xsi="http://www.w3.org/2001/XMLSchema-instance">
  <Response ID="xyz" Type="KnownDevices" refID="DeviceQuery" xsi:type="ResponseKnownDevices">
    <DeviceList>
      <DeviceInfo DeviceStatus="Idle">
        <Device Class="Implementation" DeviceID="Joe the Drum"
          KnownLocalizations="En Fre" ModelName="Bongo">
          <DeviceCap
            GenericAttributes="ID Class SettingsPolicy BestEffortExceptions OperatorInterventionExceptions MustHonorExceptions PartIDKeys DocIndex"
            Lang="Fre" Type="Scanning">
            <!-- the scanner takes a minute to set up and scans an average
              of 2 sheets a min. -->
            <Performance AverageAmount="120" AverageSetup="PT2M" Name="ExposedMedia"/>
            <DevCaps Name="NodeInfo">
              <DevCap>
                <!--NodeInfo only supports JobPriority and TargetRoute Attributes -->
                <StringState HasDefault="false" Name="TargetRoute"/>
                <IntegerState HasDefault="false" Name="JobPriority"/>
              </DevCap>
            </DevCaps>
            <DevCaps Name="ExposedMedia">
              <DevCap>
                <!-- ExposedMedia restrictions -->
                <DevCap Name="Media">
                  <NameState DefaultValue="Sheet" Name="MediaUnit"/>
                  <XYPairState AllowedValueMax="600 1200"
                    AllowedValueMin="0 0" HasDefault="false" Name="Dimension"/>
                </DevCap>
              </DevCap>
            </DevCaps>
            <DevCaps Name="ScanParams">
              <Loc
                HelpText="Les parametres pour commander le procede de balayage." Value="Les parametres
de module de balayage"/>
              <DevCap>
                <!-- Black and white 1 bit mode -->
                <IntegerState AllowedValueMax="1" AllowedValueMin="1"
                  DefaultValue="8" Name="BitDepth"/>
                <EnumerationState AllowedValueList="CCITTFaxEncode None"
                  HasDefault="false" Name="CompressionFilter">
                  <Loc
                    HelpText="Choisissez la compression pour reduire la taille de donnees." Value="La
compression de donnees"/>
                </EnumerationState>
              </DevCap>
            </DevCaps>
          </DeviceCap>
        </DeviceInfo>
      </DeviceList>
    </Response>
  </JMF>
```

DEVICE CAPABILITIES

```

    <ValueLoc Value="CCITTFaxEncode">
      <Loc Value="Compression de CCITT Fax"/>
    </ValueLoc>
    <ValueLoc Value="None">
      <Loc Value="Aucun compression"/>
    </ValueLoc>
  </EnumerationState>
  <NumberState AllowedValueMax="10"
    AllowedValueMin="1.e-002" HasDefault="false" Name="Magnification">
    <Loc ShortValue="Rapport optique" Value="Rapport de rapport optique d'image"/>
  </NumberState>
  <EnumerationState AllowedValueList="GrayScale"
    HasDefault="false" Name="OutputColorSpace">
  <Loc ShortValue="Format de couleur" Value="Configurez le format de couleur de module
de balayage"/>
    <ValueLoc Value="GrayScale">
      <Loc Value="echelle de gris"/>
    </ValueLoc>
  </EnumerationState>
  <XYPairState DefaultValue="2400 2400" Name="OutputResolution">
    <Loc ShortValue="resolution" Value="Resolution de module de balayage"/>
  </XYPairState>
</DevCap>
<DevCap>
  <!-- Grayscale 12 bit mode -->
  <IntegerState AllowedValueMax="12" AllowedValueMin="12"
    DefaultValue="8" Name="BitDepth">
    <Loc Value="Le profondeur de bit"/>
  </IntegerState>
  <EnumerationState
    AllowedValueList="FlateEncode DCTEncode None"
    HasDefault="false" Name="CompressionFilter">
    <Loc
      HelpText="Choisissez la compression pour reduire la taille de donnees." Value="La
compression de donnees"/>
    <ValueLoc Value="FlateEncode">
      <Loc Value="Compression de Flate"/>
    </ValueLoc>
    <ValueLoc Value="DCTEncode">
      <Loc Value="Compression de DCTE"/>
    </ValueLoc>
    <ValueLoc Value="None">
      <Loc Value="Aucun compression"/>
    </ValueLoc>
  </EnumerationState>
  <NumberState AllowedValueMax="10"
    AllowedValueMin="0.001" DefaultValue="1.0" Name="Magnification">
    <Loc ShortValue="Rapport optique" Value="Rapport de rapport optique d'image"/>
  </NumberState>
  <EnumerationState AllowedValueList="GrayScale"
    HasDefault="false" Name="OutputColorSpace">
  <Loc ShortValue="Format de couleur" Value="Configurez le format de couleur de module
de balayage"/>
    <ValueLoc Value="GrayScale">
      <Loc Value="Echelle de gris"/>
    </ValueLoc>
  </EnumerationState>
  <XYPairState AllowedValueMax="2400 2400"
    AllowedValueMin="100 100" DefaultValue="600 600" Name="OutputResolution">
    <Loc ShortValue="resolution" Value="Resolution de module de balayage"/>
  </XYPairState>
</DevCap>
<DevCap>
  <!-- Color 10 bit mode -->
  <IntegerState AllowedValueMax="10" AllowedValueMin="10"
    DefaultValue="8" Name="BitDepth">
    <Loc Value="Le profondeur de bit"/>
  </IntegerState>
  <EnumerationState
    AllowedValueList="FlateEncode DCTEncode None" Name="CompressionFilter">
    <Loc
      HelpText="Choisissez la compression pour reduire la taille de donnees." Value="La
compression de donnees"/>
    <ValueLoc Value="FlateEncode">
      <Loc Value="Compression de Flate"/>
    </ValueLoc>
    <ValueLoc Value="DCTEncode">

```

```

    <Loc Value="Compression de DCTE"/>
  </ValueLoc>
  <ValueLoc Value="None">
    <Loc Value="Aucun compression"/>
  </ValueLoc>
</EnumerationState>
<NumberState AllowedValueMax="10"
  AllowedValueMin="1.e-002" Name="Magnification">
  <Loc ShortValue="Rapport optique" Value="Rapport de rapport optique d'image"/>
</NumberState>
<EnumerationState AllowedValueList="CMYK RGB LAB" Name="OutputColorSpace">
<Loc ShortValue="Format de couleur" Value="Configurez le format de couleur de module
de balayage"/>
  <ValueLoc Value="CMYK">
    <Loc Value="Couleur de CMYK"/>
  </ValueLoc>
  <ValueLoc Value="RGB">
    <Loc Value="Couleur de RGB"/>
  </ValueLoc>
  <ValueLoc Value="LAB">
    <Loc Value="Couleur de LAB"/>
  </ValueLoc>
</EnumerationState>
<XYPairState AllowedValueMax="2400 2400"
  AllowedValueMin="100 100" DefaultValue="600 600" Name="OutputResolution">
  <Loc ShortValue="resolution" Value="Resolution de module de balayage"/>
</XYPairState>
</DevCap>
</DevCaps>
</DeviceCap>
</Device>
</DeviceInfo>
</DeviceList>
</Response>
</JMF>

```

10.2.14.2 Device Description of a Scanner #2

This second example illustrates the use of constraints, macros and **DisplayGroup** elements in a capability response. For the sake of simplicity, the only localizations returned are for the constraints.

Example 10.6: KnownDevices Query for a Scanner #2

```

<JMF MaxVersion="1.6" SenderID="Controller"
  Timestamp="2005-04-05T16:45:43+02:00" Version="1.6"
  xmlns="http://www.CIP4.org/JDFSchema_1_1" xmlns:xsi="http://www.w3.org/2001/XMLSchema-instance">
  <Query ID="DeviceQuery" Type="KnownDevices" xsi:type="QueryKnownDevices">
    <DeviceFilter DeviceDetails="Capability" Localization="en"/>
  </Query>
</JMF>

```

Example 10.7: KnownDevices Response for a Scanner #2

```

<JMF DescriptiveName="Example from JDF 1.2 Spec Document"
  MaxVersion="1.6" SenderID="Scanner" Timestamp="2004-10-17T14:30:47Z"
  Version="1.6" xmlns="http://www.CIP4.org/JDFSchema_1_1" xmlns:xsi="http://www.w3.org/2001/
XMLSchema-instance">
  <Response Acknowledged="false" ID="xyz" ReturnCode="0"
    Type="KnownDevices" refID="DeviceQuery" xsi:type="ResponseKnownDevices">
    <DeviceList>
      <DeviceInfo DeviceStatus="Idle">
        <Device DeviceID="Joe the Drum" ModelName="Bongo">
          <DeviceCap CombinedMethod="None" ExecutionPolicy="AllFound"
            GenericAttributes="ID Class SettingsPolicy BestEffortExceptions
OperatorInterventionExceptions MustHonorExceptions PartIDKeys DocIndex" Type="Scanning">
            <Performance AverageAmount="120.0" Name="ExposedMedia"/>
            <FeaturePool>
              <EnumerationState
                AllowedValueList="Mono ColorTransparency Photo"
                DevNS="http://www.CIP4.org/JDFSchema_1_1"
                Editable="true" HasDefault="true" ID="sm"
                ListType="SingleValue" MacroRefs="ScanModeMacro"
                MaxOccurs="1" MinOccurs="1" Name="ScanMode" UserDisplay="Display"/>
            </FeaturePool>
            <DisplayGroupPool>

```

```

        <DisplayGroup rRefs="btd cmp mag colorspace outputres">
            <Loc HelpText="Parameters for scanning configuration"
                Lang="en" ShortValue="ScanningParameters"/>
        </DisplayGroup>
    </DisplayGroupPool>
    <ActionPool>
        <Action ID="BD-bw-action" Severity="Error" TestRef="BD-bw">
            <Loc
                HelpText="For 1 bit grayscale, please select CCITTFaxEncoding"
                Lang="en" ShortValue="Ouch!" Value="Flate and DCT Encoding not allowed on 1 bit
images"/>
            </Action>
        <Action ID="ctcmp-action" Severity="Error" TestRef="ctcmp">
            <Loc
                HelpText="Only select CCITTFaxEncoding for 1 bit documents"
                Lang="en" ShortValue="Ouch!" Value="CCITTFaxEncoding not supported on grayscale
images"/>
            </Action>
        <Action ID="cd-action" Severity="Error" TestRef="cd">
            <Loc
                HelpText="Choose a bit depth of 10 or less for color images"
                Lang="en" ShortValue="Ouch!" Value="Bit depths higher than 10 are not supported
for color"/>
            </Action>
        </ActionPool>
    <TestPool>
        <Test ID="iscolor">
            <EnumerationEvaluation ValueList="RGB LAB CMYK" rRef="colorspace"/>
        </Test>
        <Test ID="is1bit">
            <IntegerEvaluation ValueList="1" rRef="btd"/>
        </Test>
        <Test ID="BD-bw">
            <and>
                <TestRef rRef="is1bit"/>
                <EnumerationEvaluation
                    ValueList="FlateEncode DCTEncode" rRef="cmp"/>
            </and>
        </Test>
        <Test ID="ctcmp">
            <and>
                <not>
                    <TestRef rRef="is1bit"/>
                </not>
                <EnumerationEvaluation ValueList="CCITTFaxEncode" rRef="cmp"/>
            </and>
        </Test>
        <Test ID="cd">
            <and>
                <TestRef rRef="iscolor"/>
                <IntegerEvaluation ValueList="1 10" rRef="btd"/>
            </and>
        </Test>
    </TestPool>
    <MacroPool>
        <macro ID="ScanModeMacro">
            <choice>
                <when>
                    <EnumerationEvaluation ValueList="Mono" rRef="sm"/>
                    <set rRef="btd">
                        <FeatureAttribute CurrentValue="1"/>
                    </set>
                    <set rRef="colorspace">
                        <FeatureAttribute CurrentValue="GrayScale"/>
                    </set>
                    <set rRef="outputres">
                        <FeatureAttribute CurrentValue="1200 1200"/>
                    </set>
                </when>
                <when>
                    <EnumerationEvaluation ValueList="ColorTransparency" rRef="sm"/>
                    <set rRef="btd">
                        <FeatureAttribute CurrentValue="8"/>
                    </set>
                    <set rRef="colorspace">
                        <FeatureAttribute CurrentValue="RGB"/>
                    </set>
                </when>
            </choice>
        </macro>
    </MacroPool>

```

```

    <set rRef="outputres">
      <FeatureAttribute CurrentValue="600 600"/>
    </set>
  </when>
</when>
<when>
  <EnumerationEvaluation ValueList="Photo" rRef="sm"/>
  <set rRef="btd">
    <FeatureAttribute CurrentValue="10"/>
  </set>
  <set rRef="colorspace">
    <FeatureAttribute CurrentValue="LAB"/>
  </set>
  <set rRef="outputres">
    <FeatureAttribute CurrentValue="200 200"/>
  </set>
</when>
</choice>
</macro>
</MacroPool>
<DevCaps Availability="Installed" Context="Resource"
  DevNS="http://www.CIP4.org/JDFSchema_1_1" Name="NodeInfo"
  Required="false" ResourceUpdate="None">
  <DevCap DevNS="http://www.CIP4.org/JDFSchema_1_1"
    MaxOccurs="1" MinOccurs="1" Name="NodeInfo">
    <StringState DevNS="http://www.CIP4.org/JDFSchema_1_1"
      Editable="true" HasDefault="true"
      ListType="SingleValue" MaxOccurs="1" MinOccurs="1"
      Name="TargetRoute" UserDisplay="Display"/>
    <IntegerState DevNS="http://www.CIP4.org/JDFSchema_1_1"
      Editable="true" HasDefault="true"
      ListType="SingleValue" MaxOccurs="1" MinOccurs="1"
      Name="JobPriority" UserDisplay="Display"/>
  </DevCap>
</DevCaps>
<DevCaps Availability="Installed" Context="Resource"
  DevNS="http://www.CIP4.org/JDFSchema_1_1"
  Name="ExposedMedia" Required="false" ResourceUpdate="None">
  <DevCap DevNS="http://www.CIP4.org/JDFSchema_1_1"
    MaxOccurs="1" MinOccurs="1" Name="ExposedMedia">
    <DevCap DevNS="http://www.CIP4.org/JDFSchema_1_1"
      MaxOccurs="1" MinOccurs="1" Name="Media">
      <NameState DefaultValue="Sheet"
        DevNS="http://www.CIP4.org/JDFSchema_1_1"
        Editable="true" HasDefault="true"
        ListType="SingleValue" MaxOccurs="1" MinOccurs="1"
        Name="MediaUnit" UserDisplay="Display"/>
      <XYPairState AllowedValueMax="600.0 1200.0"
        AllowedValueMin="0.0 0.0"
        DevNS="http://www.CIP4.org/JDFSchema_1_1"
        Editable="true" HasDefault="true"
        ListType="SingleValue" MaxOccurs="1" MinOccurs="1"
        Name="Dimension" UserDisplay="Display"/>
    </DevCap>
  </DevCap>
</DevCaps>
<DevCaps Availability="Installed" Context="Resource"
  DevNS="http://www.CIP4.org/JDFSchema_1_1"
  Name="ScanParams" Required="false" ResourceUpdate="None">
  <DevCap DevNS="http://www.CIP4.org/JDFSchema_1_1"
    MaxOccurs="1" MinOccurs="1" Name="ScanParams">
    <IntegerState ActionRefs="BD-bw ctcmp cd"
      AllowedValueList="1 4 8 10 12" DefaultValue="1"
      DevNS="http://www.CIP4.org/JDFSchema_1_1"
      Editable="true" HasDefault="true" ID="btd"
      ListType="SingleValue" MaxOccurs="1" MinOccurs="1"
      Name="BitDepth" UserDisplay="Hide"/>
    <EnumerationState ActionRefs="BD-bw ctcmp"
      AllowedValueList="CCITTFaxEncode FlateEncode DCTEncode None"
      DevNS="http://www.CIP4.org/JDFSchema_1_1"
      Editable="true" HasDefault="true" ID="cmp"
      ListType="SingleValue" MaxOccurs="1" MinOccurs="1"
      Name="CompressionFilter" UserDisplay="Hide"/>
    <NumberState AllowedValueMax="100.0"
      AllowedValueMin="0.01"
      DevNS="http://www.CIP4.org/JDFSchema_1_1"
      Editable="true" HasDefault="true" ID="mag"
      ListType="SingleValue" MaxOccurs="1" MinOccurs="1"

```

```

        Name="Magnification" UserDisplay="Display"/>
    <EnumerationState ActionRefs="cd"
        AllowedValueList="GrayScale CMYK RGB LAB"
        DevNS="http://www.CIP4.org/JDFSchema_1_1"
        Editable="true" HasDefault="true" ID="Colorspace"
        ListType="SingleValue" MaxOccurs="1" MinOccurs="1"
        Name="OutputColorSpace" UserDisplay="Display"/>
    <XYPairState
        AllowedValueList="100.0 100.0 300.0 300.0 600.0 600.0 1200.0 1200.0 2400.0 2400.0"
        DefaultValue="600.0 600.0"
        DevNS="http://www.CIP4.org/JDFSchema_1_1"
        Editable="true" HasDefault="true" ID="outputres"
        ListType="SingleValue" MaxOccurs="1" MinOccurs="1"
        Name="OutputResolution" UserDisplay="Display"/>
    </DevCap>
</DevCaps>
</DeviceCap>
</Device>
</DeviceInfo>
</DeviceList>
</Response>
</JMF>

```

Example 10.8: JDF Accepted by Previous Scanner

Example of **JDF** node that is accepted by the scanner of the previous example. All parameters of the following scanning node are compliant with the capabilities.

```

<JDF ID="GoodScan" JobPartID="ID300" Status="Waiting" Type="Scanning"
    Version="1.6" xmlns="http://www.CIP4.org/JDFSchema_1_1">
    <ResourcePool>
        <ScanParams BitDepth="8" Class="Parameter" ID="Link0007"
            OutputColorSpace="RGB" OutputResolution="600. 600." Status="Available"/>
        <ExposedMedia Class="Handling" ID="Link0008" Status="Available">
            <Media Dimension="425.196850394 566.929133858"/>
        </ExposedMedia>
        <RunList Class="Parameter" ID="Link0014" Status="Available"/>
    </ResourcePool>
    <ResourceLinkPool>
        <ScanParamsLink Usage="Input" rRef="Link0007"/>
        <ExposedMediaLink Usage="Input" rRef="Link0008"/>
        <RunListLink Usage="Output" rRef="Link0014"/>
    </ResourceLinkPool>
</JDF>

```

Example 10.9: JDF Rejected by Previous Scanner

Example of **JDF** node that is rejected by the scanner of the previous example. All parameters of the following scanning node except **Magnification** are compliant with the device capabilities. Therefore, the device can not execute the job.

```

<JDF ID="BadScan" JobPartID="ID300" Status="Waiting" Type="Scanning"
    Version="1.6" xmlns="http://www.CIP4.org/JDFSchema_1_1">
    <ResourcePool>
        <ScanParams BitDepth="8" Class="Parameter" ID="Link0012"
            Magnification="1000. 1000." OutputColorSpace="RGB"
            OutputResolution="600. 600." Status="Available"/>
        <ExposedMedia Class="Handling" ID="Link0013" Status="Available">
            <Media Dimension="425.196850394 566.929133858"/>
        </ExposedMedia>
        <RunList Class="Parameter" ID="Link0014" Status="Available"/>
    </ResourcePool>
    <ResourceLinkPool>
        <ScanParamsLink Usage="Input" rRef="Link0012"/>
        <ExposedMediaLink Usage="Input" rRef="Link0013"/>
        <RunListLink Usage="Output" rRef="Link0014"/>
    </ResourceLinkPool>
</JDF>

```

10.3 Concept of the Preflight Process

New in JDF 1.2

Note: This section establishes elements, attributes and attribute values that are used by the resources referenced by the **Preflight** process, including **PreflightParams**, **PreflightReportRulePool** and **PreflightReport**, as well as extensions of testing methodology established **Action** and **Test** functions defined in ▶ Section 10.2.1 DeviceCap.

In order to define one **Test**, you can combine one or more basic tests using the boolean logic as defined in ▶ Section 10.2 Device Capability Definitions. Each basic test is applied to one defined property with a given data type. Note that document properties defined in this section include one or more attributes that are extracted from documents (e.g., a client's PDF file) and used by one or more evaluations as part of a preflight test. Each data type can be tested on an object using its matching **Evaluation**. A document that is preflighted is made of objects. Some of them, like virtual boxes (**TrimBox** or **MediaBox**) are not visible. In order to combine basic tests together, they have been classified by groups of properties. These groups do not necessarily match a class of an object. However, each class of object will implement one or more groups of properties.

The rules to combine basic tests into a **Test** can be built on both object classes and groups of properties. Each basic test takes an object as an input and has four different states in output: "false", "true", "TestWrongPDL" or "TestNotSupported". The two last values occur when a basic test has no meaning for the given object or when the application that is executing the test does not support that test. These four different states lead to a more open way of dealing with boolean logic

"false"	AND	"TestWrongPDL"	=	"false"
"true"	OR	"TestWrongPDL"	=	"true"
"false"	AND	"TestNotSupported"	=	"false"
"true"	OR	"TestNotSupported"	=	"true"
"true"	AND	"TestWrongPDL"	=	"TestWrongPDL"
"false"	OR	"TestWrongPDL"	=	"TestWrongPDL"
"true"	AND	"TestNotSupported"	=	"TestNotSupported"
"false"	OR	"TestNotSupported"	=	"TestNotSupported"
"TestWrongPDL"	OR	"TestNotSupported"	=	"TestNotSupported"
"TestWrongPDL"	AND	"TestNotSupported"	=	"TestNotSupported"
if ("true")		Report according to action.		
if ("false")		Do not report.		
if ("TestWrongPDL")		Report problem if specified in PRRule .		
if ("TestNotSupported")		Report problem if specified in PRRule .		

For instance, "TestWrongPDL" would occur when a test about font size is made on a page. "TestNotSupported" would happen when a **JDF** preflight agent does not support the concept of font size.

10.3.1 Object Classes

▶ Table 10.69 Object Classes for a Document below has a list of the real objects that can be preflighted in a document. The objects are identified by their class name specified in the "Name" column:

Table 10.69: Object Classes for a Document (Sheet 1 of 2)

NAME	DESCRIPTION
Annotation	An annotation is a complex object that adds information to the page of a document. The characteristic of such object is that it is optional to print it. When an annotation is set to be printed, the graphical objects making the annotation are considered separated objects.
Document	The document, which is preflighted.
Font	A font is a set of characters that can be used to draw text. A font can be in a document without being used by any text of the document.
Image	An image is a graphic object drawn with colored pixels.
MaskUsingImage	This object is an object that masks another object using an image.
MaskUsingVector	This object is an object that masks another object using a vector path.
MaskUsingText	This object is an object that masks another object using text components.
Mask	A mask is an object used to mask or clip a graphic object.
Page	A document can be made of finished pages (but could be empty as well).
PageBox	In each finished page, some virtual boxes can be defined (page size and margins). Some tests can be done with these boxes.

Table 10.69: Object Classes for a Document (Sheet 2 of 2)

NAME	DESCRIPTION
PDL	A PDL object is a generic kind of object that can be specific to some types of documents. It is just a way to detect presence or not of such objects.
Shading	A shading is a graphic object drawn using a smooth color change from one point to another.
Text	A text is a set of characters that have exactly the same style (i.e., same size, same font, same fill and stroke, etc.).
Vector	A vector is a graphic object drawn with vector curves. It is made of a fill and a stroke.

10.3.1.1 Properties Implemented by each Class of Object

► Table 10.70 Properties Implemented by each Class of Object below, has columns of object classes and rows of properties Categories. An “X” in a cell means that an object of the specified class implements the specified properties (see ► Table 10.72 List of Properties Categories).

Table 10.70: Properties Implemented by each Class of Object

PROPERTIES	CLASSES													
	DOCUMENT	PAGE	IMAGE	VECTOR	TEXT	SHADING	IMAGEMASK	ANNOTATION	PAGEBOX	FONT	MASKUSINGIMAGE	MASKUSINGVECTOR	MASKUSINGTEXT	PDL
Logical	X	X	X	X	X	X	X	X	X	X	X	X	X	X
Class	X	X	X	X	X	X	X	X	X	X	X	X	X	X
Document	X	X	X	X	X	X	X	X	X	X	X	X	X	X
Page		X	X	X	X	X	X	X	X	X	X	X	X	X
Reference			X	X										
Colorant	X		X	X	X	X	X							
Box		X	X	X	X	X	X	X	X		X	X	X	X
Graphic			X	X	X	X	X							
Fill				X	X		X							
Stroke				X	X									
Image			X				X				X			
Vector				X								X		
Text					X								X	
Shading						X								
Font					X					X				
Annotation								X						
Page Box									X					
PDL Object														X

10.3.1.2 Checking for the Presence of a Property

In most of the **Preflight** process, only the “values” of properties are needed. Please note that a property MAY incorporate one or more attributes, and it is the values (e.g., string or enumeration) of these attributes that are collectively referred to here as the “value” of the property. In some cases, it is also useful to be able to check if a property has been defined. This happens in some types of documents where the property definition is optional. Before checking its value, you just want to check that this property was defined.

For all the basic tests described in this document where it makes sense to check if they are defined, they are checked “Yes” in the **Tag** column of properties definition tables below. Use the **IsPresentEvaluation** to check for the presence of a property.

Example 10.10: Test for Existence of TrappedKey

This example checks if the @TrappedKey is defined in a PDF document.

```
<Device Class="Implementation" ID="Link0003" Status="Available">
  <DeviceCap>
    <TestPool>
      <Test ID="PT01">
        <IsPresentEvaluation>
          <BasicPreflightTest Name="TrappedKey"/>
        </IsPresentEvaluation>
      </Test>
    </TestPool>
  </DeviceCap>
</Device>
```

Example 10.11: Test for TrappedKey Equal to “Unknown”

This example checks if the value of the @TrappedKey = "Unknown" in a PDF document.

```
<Device Class="Implementation" ID="Link0003" Status="Available">
  <DeviceCap>
    <TestPool>
      <Test ID="PT02">
        <EnumerationEvaluation ValueList="Unknown">
          <BasicPreflightTest Name="TrappedKey"/>
        </EnumerationEvaluation>
      </Test>
    </TestPool>
  </DeviceCap>
</Device>
```

Table 10.71: Mapping between property types (in the preflight spec) and evaluations (Sheet 1 of 2)

PROPERTY TYPE	EVALUATION	EXPECTED USAGE FOR BASICPREFLIGHTTEST LISTTYPE
presence	IsPresentEvaluation	-
boolean	BooleanEvaluation	SingleValue.
BooleanList	BooleanEvaluation	Any of @ListType’s value that refers to a list.
DateTime	DateTimeEvaluation	SingleValue.
DateTimeList	DateTimeEvaluation	Any of @ListType’s value that refers to a list.
enumeration	NameEvaluation	SingleValue.
enumerations	NameEvaluation	Any of @ListType’s value that refers to a list.
integer	IntegerEvaluation	SingleValue.

Table 10.71: Mapping between property types (in the preflight spec) and evaluations (Sheet 2 of 2)

PROPERTY TYPE	EVALUATION	EXPECTED USAGE FOR BASICPREFLIGHTTEST LISTTYPE
IntegerList	<i>IntegerEvaluation</i>	Any of @ListType’s value that refers to a list.
Name	<i>NameEvaluation</i>	SingleValue.
NameList	<i>NameEvaluation</i>	Any of @ListType’s value that refers to a list.
double	<i>NumberEvaluation</i>	SingleValue.
DoubleList	<i>NumberEvaluation</i>	Any of @ListType’s value that refers to a list.
rectangle	<i>RectangleEvaluation</i>	SingleValue.
RectangleList	<i>RectangleEvaluation</i>	Any of @ListType’s value that refers to a list.
string	<i>StringEvaluation</i>	SingleValue.
StringList	<i>StringEvaluation</i>	Any of @ListType’s value that refers to a list.
XYPair	<i>XYPairEvaluation</i>	SingleValue.
XYPairList	<i>XYPairEvaluation</i>	Any of @ListType’s value that refers to a list.

10.3.1.3 Basic tests on set of objects

Some properties can be applied to more than one object and have a value when applied to a list of objects which differs from their value when applied to a single object. For instance, this allows you to make tests on the number of separations of objects included in a given area. These properties have the column “Set” checked with “Yes”. In order to define a **Test** using such properties, a list of objects is filtered first, before applying the test. This is achieved using the **PreflightArgument** element.

10.3.2 Properties

▶ Table 10.72 List of Properties Categories specifies the properties categories. In each of the following subsections, there is a table with a list of attributes belonging to the specified properties category. Each such attribute can be found, extracted, and evaluated from a document. The attributes of each properties category apply to objects of certain specified classes (see ▶ Table 10.71 Mapping between property types (in the preflight spec) and evaluations).

Note: Each table of properties in the subsections below has a different meaning from a table for an element or resource, which describes an XML element along with its member attributes or subelements. A properties table does not describe an XML element or any other structure. Rather each table row describes an attribute that is a potential attribute of some element derived from **Abstract PRGroupOccurrenceBase** element (see ▶ Table 8.201 List of PRGroupOccurrenceBase Elements).

Note: For each properties tables, the “Set” column is described in ▶ Section 10.3.1.3 Basic tests on set of objects, and the “Tag” column is described in ▶ Section 10.3.1.2 Checking for the Presence of a Property.

Table 10.72: List of Properties Categories (Sheet 1 of 2)

NAME	PAGE	DESCRIPTION
▶ Annotation Properties	page 699	Describes annotations.
▶ Box Properties	page 700	Describes a container box
▶ Class Properties	page 700	Describes the class name and property name

Table 10.72: List of Properties Categories (Sheet 2 of 2)

NAME	PAGE	DESCRIPTION
▶ Colorant Properties	page 701	Describes color and separation information.
▶ Document Properties	page 702	Describes a document.
▶ Fill Properties	page 705	Describes fill for graphic objects
▶ Font Properties	page 705	Describes fonts in a document:
▶ Graphic Properties	page 707	Describes display and graphic information
▶ Image Properties	page 708	Describes images displayed using pixels
▶ Logical Properties	page 710	Mainly used with “ Set ” to count the number of objects
▶ PageBox Properties	page 710	Describes virtual boxes for each page.
▶ Pages Properties	page 710	Describes a page in a document
▶ PDLObject Properties	page 712	Describes particular PDF objects in a document
▶ Reference Properties	page 712	Describes references to external objects.
▶ Shading Properties	page 712	Describes shading that is applied graphic objects.
▶ Stroke Properties	page 713	Describes strokes applied to graphic objects with vector primitives
▶ Text Properties	page 713	Describes text.
▶ Vector Properties	page 714	Describes graphic objects with vector primitives.

10.3.2.1 Annotation Properties

Annotation objects are specific objects that can be displayed or printed according to the user’s choice. When they are displayed or printed, they add graphical objects to the document that can be preflighted.

Table 10.73: Annotation Properties

NAME	TYPE	DESCRIPTION	SET	TAG	DOCUMENTS
<i>AnnotationPrintFlag</i>	boolean	Is “true” when it will be printed on the final document.	—	—	PDF
<i>AnnotationType</i>	NMTOKEN	The type of annotations. Values include those from: ▶ Table 10.74 AnnotationType Attribute Values.	—	—	PDF
<i>TrapnetAnnotationPDFX</i>	NMTOKENS	The PDF/X versions to which the @TrapNet annotation complies (e.g., “PDF/X-1a:2003”).	—	—	PDF

Table 10.74: AnnotationType Attribute Values (Sheet 1 of 2)

VALUE	DESCRIPTION	VALUE	DESCRIPTION
Circle		Sound	
FileAttachment		Square	

Table 10.74: AnnotationType Attribute Values (Sheet 2 of 2)

VALUE	DESCRIPTION	VALUE	DESCRIPTION
FreeText		Squiggly	
Highlight		Stamp	
Ink		StrikeOut	
Link		Text	
Line		TrapNet	
Movie		Underline	
Popup		Widget	
PrinterMark			

10.3.2.2 Box Properties

All visible objects can be described at least by a box in which they can be contained. In a page, some kind of boxes can define some basic box properties that are extracted as attributes for use in a test.

Table 10.75: Box Properties

NAME	TYPE	DESCRIPTION	SET	TAG	DOCUMENTS
<i>BoundingBox</i>	rectangle	The bounding box of the object is the smallest rectangle containing the object. When used with group of objects, this is the smallest box containing boxes of all objects.	Yes	—	—
<i>DifferentBoxSize</i>	enumerations	This is the list of boxes, which are different on one page from the same boxes on another page. Allowed values are from: ▶ BoxType.	Only	—	—
<i>InsideBox</i>	boolean	Is "true" when an object is inside a given box. @ <i>InsideBox</i> SHALL be qualified by <i>BoxArgument</i> subelement.	—	—	—
<i>OutsideBox</i>	boolean	Is "true" when an object is outside a given box. @ <i>OutsideBox</i> SHALL be qualified by <i>BoxArgument</i> subelement.	—	—	—

10.3.2.3 Class Properties

Each object can define the name of the class of objects it belongs to:

Table 10.76: Class Properties

NAME	TYPE	DESCRIPTION	SET	TAG	DOCUMENTS
<i>ClassName</i>	NMTOKEN	The name of the class to which the object belongs. Values include those from: ▶ Table 10.77 ClassName Attribute Values.	—	—	—
<i>PropertyList</i>	enumerations	The list of properties the object has. Allowed values are from: ▶ Table 10.78 PropertyList Attribute Values.	—	—	—

Table 10.77: ClassName Attribute Values

VALUE	DESCRIPTION	VALUE	DESCRIPTION
Annotation		MaskUsingVector	
Document		Page	
Font		PageBox	
Image		PDL	
ImageMask		Shading	
MaskUsingImage		Text	
MaskUsingText		Vector	

Table 10.78: PropertyList Attribute Values

VALUE	DESCRIPTION	VALUE	DESCRIPTION
Annotation		Logical	
Box		Page	
Class		PageBox	
Colorant		PDLObject	
Document		Reference	
Fill		Shading	
Font		Stroke	
Graphic		Text	
Image		Vector	

10.3.2.4 Colorant Properties

Every visible object or group of objects will imply a given number of separations.

Table 10.79: Colorant Properties (Sheet 1 of 2)

NAME	TYPE	DESCRIPTION	SET	TAG	DOCUMENTS
<i>AliasSeparations</i>	boolean	Is "true" when some of the separations have different names but the same color values.	Yes	—	—
<i>AmbiguousSeparations</i>	boolean	Is "true" when some of the separations have the same name but different color values.	Yes	—	—
<i>InkCoverage</i>	double	This is the maximum percentage of ink coverage for one object. In case of a group of objects, this is the maximum amount of ink coverage for the list of objects. The method of calculation can be application-dependent and can differ from one application to another. Some applications MAY check the coverage object by object without taking into account overprint or transparencies between objects; some others MAY use a rasterization process to get the coverage of the combined objects.	Yes	—	—

Table 10.79: Colorant Properties (Sheet 2 of 2)

NAME	TYPE	DESCRIPTION	SET	TAG	DOCUMENTS
<i>SeparationList</i>	string	List of all separations necessary to print one object or a group of objects.	Yes	—	—

10.3.2.5 Document Properties

This is the list of properties (attributes) that define parts of a document.

Table 10.80: Document Properties (Sheet 1 of 4)

NAME	TYPE	DESCRIPTION	SET	TAG	DOCUMENTS
<i>Author</i>	string	A string describing the author of the document.	—	Yes	—
<i>Binding</i>	enumeration	The binding of the document: Allowed values are: <i>Left</i> <i>Right</i>	—	Yes	PDF
<i>CreationDate</i>	dateTime	The date when the document was created according to the file system.	—	—	—
<i>CreationDateInDocument</i>	dateTime	The date when the document was created according to data inside the document.	—	Yes	—
<i>CreationID</i>	NMTOKEN	An NMTOKEN which identifies a document when created. The <i>@CreationID</i> SHALL be unique within the workflow. In case of a PDF, it matches exactly the first element of ID array.	—	Yes	—
<i>Creator</i>	string	A string describing the creator of the document. This is usually the name and version of the authoring application used. In case of PS and PDF files, it matches exactly the Creator key.	—	Yes	—
<i>DocumentCompression</i>	enumerations	A list of all compression types used in the document (including image compression referenced by <i>@CompressionTypes</i> in <i>Image Properties</i>). Allowed values are from: <i>@CompressionTypes</i> in ▶ Table 10.86 Image Properties.	—	—	—
<i>DocumentCorruption</i>	NMTOKENS	The list of recoverable errors against the document format that were found in this document. An empty list means the document is not corrupted. Values include: <i>InvalidOffsets</i> – Some offsets are invalid, but the preflight agent was able to load the document nonetheless. Note that the absence of this value does not mean that all document structures are valid, only that the offsets are correct)	—	—	—

Table 10.80: Document Properties (Sheet 2 of 4)

NAME	TYPE	DESCRIPTION	SET	TAG	DOCUMENTS
<i>DocumentEncoding</i>	enumeration	The document encoding which can be either: Allowed values are: ASCII Binary	—	—	PS, PDF
<i>DocumentIsGoodCompression</i>	boolean	Is "true" when a strong compression algorithm is used (not just an ASCII filter) for all objects in the document where it makes sense to have compression.	—	—	—
<i>EncryptedDocument</i>	boolean	Is "true" if document is encrypted.	—	—	—
<i>EncryptionFilter</i>	NMTOKEN	The filter name of encryption for a PDF file.	—	Yes	PDF
<i>EncryptionLength</i>	integer	The length of the encryption key of a PDF file in bits.	—	Yes	PDF
<i>EncryptionRestrictions</i>	NMTOKENS	The actions that are forbidden by the encryption. Values include: Assembly – Inserting or removing pages. Copying – Extracting part of the content. DisabledAccess – Allowing copying specifically for providing access to the disabled. EditingAnnotations EditingContent FillingIn – Filling in forms. HighResPrinting Printing	—	—	PDF
<i>EncryptionSubFilter</i>	NMTOKEN	The sub-filter name of encryption for a PDF file.	—	Yes	PDF
<i>EncryptionV</i>	integer	The V integer of encryption for a PDF file.	—	Yes	PDF
<i>FileName</i>	string	The file name, including file extension, in the file system. This is not the full path.	—	—	—
<i>FileSize</i>	integer	The file size expressed in bytes.	—	—	—
<i>Keywords</i>	string	A string made of keywords describing the document.	—	Yes	—
<i>Linearized</i>	boolean	Is "true" if the document is linearized (i.e., prepared for web download).	—	—	PDF
<i>ModificationDate</i>	dateTime	The date when the document was last modified according to the file system.	—	—	—
<i>ModificationDateInDocument</i>	dateTime	The date when the document was last modified according to data inside the document.	—	Yes	—

Table 10.80: Document Properties (Sheet 3 of 4)

NAME	TYPE	DESCRIPTION	SET	TAG	DOCUMENTS
<i>ModificationID</i>	NMTOKEN	A name that which can uniquely identify the current document instance. In case of a PDF, it matches exactly the second element of ID array.	—	Yes	—
<i>NumberOfPages</i>	integer	The number of finished pages contained in the document.	—	—	—
<i>OutputIntentColorSpace</i> = "None"	NMTOKEN	The color space belonging to the output intent of the document. Values include: None – The default value to be used if this property is not present. CMYK Gray RGB	—	Yes	PDF
<i>OutputIntentStandard</i>	string	The standards the output intent is compliant with (e.g., PDF/X-1a:2001). The version of the standard is assumed to be in the string accordingly to the standard's notation.	—	—	—
<i>PagesHaveSameOrientation</i>	boolean	Is "true" when all pages have the same orientation.	—	—	—
<i>PDFXVersion</i>	NMTOKEN	The PDF/X version key present in the document.	—	Yes	PDF
<i>PDLType</i>	NMTOKEN	The type of document expressed as a MIME-type. Values include those from: ▶ Table G.1 MIMEType Attribute Values (IANA Registered) and ▶ Table G.2 MIMEType and File Type Combinations. Example: @PDLType value is "application/pdf".	—	—	—
<i>PDLVersion</i>	string	The version of document according to the @PDLType. Values include those from: ▶ Table G.1 MIMEType Attribute Values (IANA Registered) and ▶ Table G.2 MIMEType and File Type Combinations.	—	—	—
<i>Producer</i>	string	A string describing the producer of the document. This is usually the name of the software used to create file. In case of PDF files, it matches exactly the producer key.	—	Yes	—
<i>SeparationFlag</i>	boolean	Is "true" if the document is made of separations or is not composite.	—	—	PS, PDF
<i>Subject</i>	string	A string describing the subject of the document.	—	Yes	—
<i>Title</i>	string	A string describing the title of the document.	—	Yes	—

Table 10.80: Document Properties (Sheet 4 of 4)

NAME	TYPE	DESCRIPTION	SET	TAG	DOCUMENTS
<i>TrappedKey</i>	enumeration	A value explaining the use of trapping on the document. Allowed values are: true false Unknown Note: The values match exactly the @ <i>TrappedKey</i> information of PDF.	—	Yes	—

10.3.2.6 Fill Properties

Fill property values are derived from graphic objects with vector primitives. They can have a fill color and a stroke color, with given colors. This is a list of properties that specifically apply to this kind of object:

Table 10.81: Fill Properties

NAME	TYPE	DESCRIPTION	SET	TAG	DOCUMENTS
<i>FillColorName</i>	string	The name of the color of the fill of the vector object.	—	—	—
<i>FillColorType</i>	enumeration	This is an enumeration of known colors to draw fill. Allowed values are from: ▶ Table 10.82 FillColorType Attribute Values.	—	—	—
<i>HasFillColor</i>	boolean	Is "true" if the vector object is drawn with a fill color.	—	—	—

Table 10.82: FillColorType Attribute Values

VALUE	DESCRIPTION
CMYBlack	Will print with 100% on Cyan, Magenta and Yellow separations and less than 100% on the Black separation.
CMYGray	Will print with the same percentage 0-100% exclusive on Cyan, Magenta and Yellow separations.
Other	Any other combinations of separations.
PureBlack	Will print as 100% on the black separation with 0% on the other separation(s).
PureGray	Will print as 1-99% on the black separation with 0% on the other separation(s).
RegistrationBlack	Will print as 100% on all the separations.
RegistrationGray	Will print as 0-100% exclusive on all the separations (assuming all the separations use the same value).
RichBlack	Will print as 100% on the black separation with more than 0% on one or more of the other separations.
White	Will print as 0% on all the separations.

10.3.2.7 Font Properties

The following is the list of property attributes that can be applied to a font contained in, or referenced into, a document:

Table 10.83: Font Properties

NAME	TYPE	DESCRIPTION	SET	TAG	DOCUMENTS
<i>EmbeddingRestrictionFlag</i>	boolean	Is "true" if a font cannot be embedded.	—	—	—
<i>FontCorrupted</i>	boolean	Is "true" if a font is corrupted or invalid. The implementation of this check MAY vary from one application to another.	—	—	—
<i>FontCreator</i>	string	The font creator.	—	—	—
<i>FontEmbedded</i>	boolean	Is "true" if a font is embedded into the document.	—	—	—
<i>FontIsStandardLatin</i>	boolean	Is "true" when all characters belong to the standard Latin character set.	—	—	—
<i>FontName</i>	string	The font name.	—	—	—
<i>FontNotUsed</i>	boolean	Is "true" if a font is not used to draw characters from the document.	—	—	—
<i>FontSubset</i>	boolean	Is "true" if a font is only a subset of a main font.	—	—	PS, PDF
<i>FontType = "Other"</i>	enumeration	This is the type of the font. Allowed values are from: ▶ Table 10.84 FontType Attribute Values.	—	—	—
<i>FontVendor</i>	string	The font vendor.	—	—	—
<i>IsDoubleByteFont</i> New in JDF 1.4	boolean	Some fonts need double-byte encoding to store characters internally	—	—	—
<i>IsFontScreenOnly</i>	boolean	Is "true" if a font referenced in the document contains only screen description.	—	—	Authoring
<i>PSFontName</i>	NMTOKEN	The PostScript font name.	—	—	PS, PDF

Table 10.84: FontType Attribute Values

VALUE	DESCRIPTION	VALUE	DESCRIPTION
CIDFontType0		Type1	
CIDFontType1		Type1CMultipleMaster	
CIDFontType2		Type2C	
CIDFontType3		Type3	
CIDFontType4		PDFType3	
OpenType		Type42	Embedded TrueType into a PostScript font.
TrueType		Unknown	Type of font that can not be resolved for any reason (i.e., missing font, etc.).
Type0	PostScript Type0 without the CID	Other	To be used when the property is not any of the values listed above.

10.3.2.8 Graphic Properties

This is a list of property attributes that specifically apply to objects that can be displayed or printed.

Table 10.85: Graphic Properties (Sheet 1 of 2)

NAME	TYPE	DESCRIPTION	SET	TAG	DOCUMENTS
<i>AlphalsShape</i>	boolean	The <i>@AlphalsShape</i> of a PS or PDF object.	—	—	PS, PDF
<i>AlternateColorSpace</i>	enumeration	The alternate color space of the object is one of the given. Allowed values are from: <i>@ColorSpace</i> .	—	Yes	PS, PDF
<i>BelongsToAnnotation</i>	boolean	Is "true" when this object belongs to an annotation.	—	—	—
<i>BlackGeneration</i>	enumeration	The <i>@BlackGeneration</i> function of a PS or PDF object. Allowed values are: <i>Identity</i> – Defines identity function. <i>Custom</i> – Used when the function is described.	—	Yes	PS, PDF
<i>BlendMode</i>	NMTOKEN	The <i>@BlendMode</i> of a PS or PDF object.	—	—	PS, PDF
<i>ColorSpace</i>	enumeration	The color space of the object. Allowed values are: <i>CalGray</i> <i>CalRGB</i> <i>CIEBasedA</i> <i>CIEBasedABC</i> <i>CIEBasedDEFG</i> <i>DeviceCMYK</i> <i>DeviceGray</i> <i>DeviceN</i> <i>DeviceRGB</i> <i>ICCBased</i> <i>Lab</i> <i>Separation</i>	—	—	PS, PDF
<i>EmbeddedPS</i>	boolean	Is "true" if a PDF object uses PostScript to be drawn.	—	—	PDF
<i>Flatness</i>	double	A number giving the value of PS or PDF <i>Flatness</i> .	—	Yes	PS, PDF
<i>HalfTone</i>	NMTOKEN	The value of the Halftone used in a document: "Named", "1", "5", "6", "10", "16".	—	Yes	PS, PDF
<i>HalfTonePhase</i>	XYPair	The value of the <i>@HalfTonePhase</i> associated with the object.	—	Yes	PS, PDF
<i>HasColorLUT</i>	boolean	Is "true" when an object is using indexed colors in a table to describe color.	—	—	—
<i>HasSoftMask</i>	boolean	Is "true" when the object is using a soft-mask using pixel values.	—	—	—
<i>NumberOfColorsInLUT</i>	integer	The number of colors in the color table used to display an indexed image.	—	—	—
<i>OverPrintFlag</i>	boolean	Is "true" when one object has been set to overprint.	—	—	—
<i>OverPrintMode</i>	integer	An integer giving the PostScript or PDF value for overprint mode.	—	—	PS, PDF

Table 10.85: Graphic Properties (Sheet 2 of 2)

NAME	TYPE	DESCRIPTION	SET	TAG	DOCUMENTS
<i>RenderingIntent</i>	NMTOKEN	The rendering intent of a PS or PDF object.	—	Yes	PS, PDF
<i>Smoothness</i>	double	A number giving the value of PS or PDF <i>@Smoothness</i> .	—	Yes	PS, PDF
<i>TransferFunction</i>	enumeration	The transfer function of a PS or PDF object. Allowed values are: <i>Custom</i> – Used when the function is described. <i>Identity</i> – Defines identity function.	—	Yes	PS, PDF
<i>TransparencyFlag</i>	boolean	Is "true" when the object has transparency. A transparency that is null has the "false" value.	—	—	—
<i>UnderColorRemoval</i>	enumeration	The <i>@UnderColorRemoval</i> function of a PS or PDF object. Allowed values are: <i>Custom</i> – Used when the function is described. <i>Identity</i> – Defines identity function.	Yes	Yes	PS, PDF

10.3.2.9 Image Properties

This group of property attributes is very specific to images displayed using pixels:

Table 10.86: Image Properties (Sheet 1 of 3)

NAME	TYPE	DESCRIPTION	SET	TAG	DOCUMENTS
<i>AlternateImages</i>	NMTOKENS	When to draw some of the alternate images that correspond with the given image. The PDF specification defines "Print" as a value, but any other application-specific value could be used. Values include: <i>Print</i>	—	Yes	PDF
<i>BitsPerSample</i>	integer	The number of bits used to represent color on every separation.	—	—	—
<i>CompressionRatio</i>	double	For all compression types to which it makes sense, the tests apply to the quality expressed as percentage of compression.	—	—	—

Table 10.86: Image Properties (Sheet 2 of 3)

NAME	TYPE	DESCRIPTION	SET	TAG	DOCUMENTS
<i>CompressionTypes</i>	enumerations	The type of method used to compress or encode the image. Allowed values are: ASCII85 ASCIIHex CCITT JBIG2 JPEG JPEG2000 LZW None RunLength ZIP Note: Where JPEG, JPEG2000 and/or JBIG2 are specified, they can be concatenated and only JPEG need be used.	—	—	—
<i>EffectiveResolution</i>	XYPair	The horizontal and vertical resolutions of the scaled image, in dots per inch.	—	—	—
<i>EstimatedJPEGQuality</i>	integer	For "JPEG" compression type, use algorithm provided below to obtain the estimated JPEG quality by doing a "reverse statistic" on the IJG library's quality-to-matrix routine. This value will be expressed as an integer, where "0" is the worse quality and "100" is the best quality.	—	—	—
<i>ImageFlipped</i>	enumeration	The way the image is flipped. Allowed values are: None Horizontal Vertical	—	—	—
<i>ImageMaskType</i>	enumeration	The type of masks used by image. Allowed values are: NoMask – Used when the image does not use specific mask. BitmapMask – Used when the image is masked using a bitmap image ColorKeyMask – Used when some colors are masked out to display the image (such like video chroma-key).	—	—	—
<i>ImageRotation</i>	integer	The number of degrees an image is rotated. A positive number represents a counterclockwise rotation. A negative number represents a clockwise rotation. Note: A 540° rotation is valid (e.g., one full rotation + 180° rotation).	—	—	—
<i>ImageScalingRatio</i>	double	The ratio between X and Y scaling of an image.	—	—	—

Table 10.86: Image Properties (Sheet 3 of 3)

NAME	TYPE	DESCRIPTION	SET	TAG	DOCUMENTS
<i>ImageSkew</i>	double	The skew angle of the image ("0" is not skewed). A positive number represents a clockwise skewing. A negative number represents a counterclockwise skewing.	—	—	—
<i>OriginalResolution</i>	XYPair	The horizontal and vertical resolutions of the image before scaling.	—	—	—
<i>PixelHeight</i>	integer	Image height in pixels.	—	—	—
<i>PixelWidth</i>	integer	Image width in pixels.	—	—	—

The JPEG quality algorithm is based on a technique used by the IJG library, see ▶ [IJPEG] — which uses a quality value in the range 0–100 and translates image data into a 8x8 matrix. The following algorithm performs a “reverse statistic” on the IJG library’s quality-to-matrix routine, which gives a matrix-to-quality routine. The formula’s used are as follows:

```
//DCTSIZE2 is the size of the matrix, 64
derived = 0.0;
for (i = 0; i < DCTSIZE2; i++){
    derived += (*qtblptr0)->quantval[i];
}
derived = derived / DCTSIZE2;
xq = (100.0 * derived - 50.0) / 57.625;
if (xq < 100.0){
    quality = (long) ((200.0 - xq) / 2.0);
} else {
    quality = (long) (5000.0 / xq);
}
```

The algorithm calculates the average value in the quantization matrix and then derives a quality value in the range of 0–100 from that average.

10.3.2.10 Logical Properties

The logical properties are mainly used with “Set” to count the number of objects.

Table 10.87: Logical Properties

NAME	TYPE	DESCRIPTION	SET	TAG	DOCUMENTS
<i>Count</i>	integer	The number of objects contained in the referenced set of objects.	Yes	—	—

10.3.2.11 PageBox Properties

The page box represents virtual boxes for each page. The following is a list of attributes that specifically apply to this kind of objects.

Table 10.88: PageBox Properties

NAME	TYPE	DESCRIPTION	SET	TAG	DOCUMENTS
<i>PageBoxType</i>	enumeration	Note: If a value for @PageBoxType is not known, the default SHALL be to leave @PageBoxType empty. Allowed values are from: <i>BoxArgument</i> /@Box (▶ Table 8.194 BoxArgument Element).	—	—	—

10.3.2.12 Pages Properties

This is the list of elements and attributes related to the page object in a document.

Table 10.89: Pages Properties

NAME	TYPE	DESCRIPTION	SET	TAG	DOCUMENTS
<i>BlankPage</i>	boolean	Is "true" when the trim box and the bleed box area, when defined, do not output any marks.	—	—	—
<i>BlendColorSpace</i>	enumeration	The page blend color space. Allowed values are from: <i>@ColorSpace</i> in ▶ Table 10.85 Graphic Properties.	—	Yes	PDF
<i>PageHasOptionalContent</i> New in JDF 1.4	boolean	Detect if a PDF has optional content (commonly called PDF layers).	—	—	—
<i>PageHasUnknownObjects</i>	boolean	Page contains unknown objects but the PDL was set to ignore these errors. Examples are the use of BX/EX in PDF.	—	—	—
<i>PageNumber</i>	integer	The page index in the <i>RunList</i> .	—	—	—
<i>PageScalingFactor</i> New in JDF 1.4	double	In a PDF file, one way of scaling a page is to use a page scale factor. This factor can be ambiguous because it is not always used by all applications.	—	—	—
<i>ReversePageNumber</i>	integer	A special page numbering which starts from the last page. The last page is "-1". This has been added to allow filtering of last page or the before last page, which is "-2". It is used to apply specific test on a document cover.	—	—	—
<i>BoxToBoxDifference</i>	element	The rectangle from calculating the differences between two rectangles: <i>@FromBox</i> and <i>@ToBox</i> . The calculation is made using the following formula: <i>@FromBox</i> (left)– <i>@ToBox</i> (left), <i>@FromBox</i> (bottom)– <i>@ToBox</i> (bottom), <i>@ToBox</i> (right)– <i>@FromBox</i> (right), <i>@ToBox</i> (top)– <i>@FromBox</i> (top). To define the two boxes used, options are given in <i>BoxToBoxDifference</i> argument. See ▶ Table 8.195 <i>BoxToBoxDifference</i> Element.	—	—	—

Note: The *BoxToBoxDifference* element is always a subelement of a *PreflightArgument*.

Example 10.12: Test with BoxToBoxDifference Element

```
<Device Class="Implementation" ID="Link0003" Status="Available">
  <DeviceCap>
    <TestPool>
      <Test ID="PT01">
        <RectangleEvaluation ValueList="0 0 10 10">
          <BasicPreflightTest Name="BoxToBoxDifference">
            <PreflightArgument>
              <BoxToBoxDifference FromBox="TrimBox" ToBox="BleedBox"/>
            </PreflightArgument>
          </BasicPreflightTest>
        </RectangleEvaluation>
      </Test>
    </TestPool>
  </DeviceCap>
</Device>
```

10.3.2.13 PDLObject Properties

The PDL object is used to check whether select objects are defined or not defined in the document, but does not check anything else as these objects are specific to one given PDL.

Table 10.90: PDLObject Properties

NAME	TYPE	DESCRIPTION	SET	TAG	DOCUMENTS
<i>PDLObjectType</i>	NMTOKEN	The type of specific PDL object. Values include: <i>AcroForm</i> – The PDF AcroForm. <i>Actions</i> – The PDF Actions. <i>Bookmarks</i> – The PDF Bookmarks. <i>JavaScript</i> – The PDF JavaScript. <i>Thread</i> – The PDF Thread. <i>Thumbnails</i> – The PDF Thumbnails.	—	—	PDF

10.3.2.14 Reference Properties

Reference property attributes describe objects that have links to external references on other objects. It only deals with OPI links and references in page to other graphical contents. This does not describe the font Properties (see ▶ Section 10.3.2.7 Font Properties).

Table 10.91: Reference Properties

NAME	TYPE	DESCRIPTION	SET	TAG	DOCUMENTS
<i>ExternalReferenceMissing</i>	boolean	Is "true" when the target of an external reference is missing.	—	—	—
<i>HasExternalReference</i>	boolean	Is "true" when some of the page graphical contents have a link on files.	—	—	—
<i>HasOPI</i>	boolean	Is "true" if there is OPI information associated with the object.	—	—	PS, PDF
<i>OPIMissing</i>	boolean	Is "true" when the target of OPI comments associated with the object is missing.	—	—	PS, PDF
<i>OPIType</i>	NMTOKEN	The OPI type of OPI comments associated with the object. Sometimes in PS, the comments are not OPI comments. Values include: <i>OPIComments</i> <i>OtherComments</i>	—	—	PS, PDF
<i>OPIVersion</i>	NMTOKENS	The OPI versions of OPI comments associated with the object.	—	—	PS, PDF

10.3.2.15 Shading Properties

Shading property attributes are derived from graphic objects with applied shading, which is usually defined as of either smooth or vector type.

Table 10.92: Shading Properties

NAME	TYPE	DESCRIPTION	SET	TAG	DOCUMENTS
<i>ShadingType</i>	enumeration	The type of shading. Allowed values are: Smooth Vector	—	—	—

10.3.2.16 Stroke Properties

Stroke property attributes are linked with graphic objects with vector primitives. They can have a fill color and a stroke color with given colors. This is a list of properties that specifically apply to this kind of object:

Table 10.93: Stroke Properties

NAME	TYPE	DESCRIPTION	SET	TAG	DOCUMENTS
<i>HasStrokeColor</i>	boolean	Is "true" if the vector object is drawn with a stroke color.	—	—	—
<i>StrokeAlternateColorSpace</i>	enumeration	The alternate color space of the stroke of one object. Allowed values are from: <i>@ColorSpace</i> in ▶ Table 10.85 Graphic Properties.	—	Yes	PS, PDF
<i>StrokeColorName</i>	string	The name of the color of the stroke of the vector object.	—	—	—
<i>StrokeColorSpace</i>	enumeration	The color space of the stroke of one object. Allowed values are from: <i>@ColorSpace</i> in ▶ Table 10.85 Graphic Properties.	—	—	PS, PDF
<i>StrokeColorType</i>	enumeration	This is an enumeration of known colors used to draw stroke. Allowed values are from: <i>@FillColorType</i> in ▶ Table 10.81 Fill Properties.	—	—	—
<i>StrokeOverprintFlag</i>	boolean	Is "true" when the stroke of one object has been set to overprint.	—	—	—
<i>StrokeShadingType</i>	enumeration	The type of shading used in the stroke. Allowed values are: Smooth Vector	—	—	—
<i>StrokeThickness</i>	double	The thickness of the stroke of the vector object.	—	—	—

10.3.2.17 Text Properties

“Text” refers to a consecutive set of one or more characters that share the same style (i.e., font, size, fill, stroke, etc.). The following are the attributes that can be applied to text:

Table 10.94: Text Properties

NAME	TYPE	DESCRIPTION	SET	TAG	DOCUMENTS
<i>CharacterProblem</i>	enumeration	Problem encountered to render character. Allowed values are: Corrupted – Used when a character was found but could not be rendered. IncorrectEncoding – Used when encoding information is missing, incomplete or otherwise incorrect. Missing – Use when the character could not be found in font. Others – Used in all other cases.	—	—	—
<i>MissingPrinterFont</i>	boolean	Is "true" if a referenced font has no printer information.	Yes	—	—
<i>MissingScreenFont</i>	boolean	Is "true" if a referenced font has no screen information.	—	—	—
<i>TextSize</i>	double	The size in points of the character.	—	—	—
<i>UseArtificialTextEffect</i>	enumerations	The artificial text effects list used to draw a character. Allowed values are: Bold Italic Outline Shadow Underline Note: The authoring applications can apply the text effect directly, whereas in PS or PDF, the effect will be calculated.	—	—	—

10.3.2.18 Vector Properties

Vector property attributes are derived from graphic objects with vector primitives. They can have a fill color and a stroke color, with given colors. This is a list of attributes that specifically apply to this kind of object:

Table 10.95: Vector Properties

NAME	TYPE	DESCRIPTION	SET	TAG	DOCUMENTS
<i>NumberOfPathPoints</i>	integer	The number of points used to create a vector path.	—	—	—

11 Building a System

11.1 Implementation Considerations and Guidelines

JDF parsing. JDF devices SHALL implement JDF parsing. At a minimum, a device SHALL be able to search the JDF to find a node whose process type it is able to execute. The details of the search algorithm are implementation dependent and can be as simple as searching only in the JDF root node. In addition, a ▶ Device SHALL be able to consume the inputs and produce the outputs for each process type it is able to execute. See ▶ Section 4.2.1 Determining Executable nodes.

Test run. To reduce failures during processing, it is RECOMMENDED that either individual devices or their controller support the test-run functionality. This prevents the case where a device begins processing a node that is incomplete or malformed.

11.2 JDF and JMF Interchange Protocol

A system of vendor-independent elements SHOULD define a protocol that allows them to interchange information based on JDF and JMF.

Controllers and devices SHOULD provide insecure http without an SSL layer for better interoperability.

11.2.1 File-Based Protocol (JDF)

The file-based protocol is a solution for JDF job tickets. A file-based protocol MAY be based on hot folders. A device that implements hot folders SHALL define an input hot folder and an output folder for JDF. In addition, the [SubmitQueueEntry](#) message contains a URL attribute that allows specification of arbitrary JDF locators. Implementation of JDF file-based protocol is simple, but it is important to note that the protocol does not support acknowledgement receipts for protocol error handling. It requires that the receiver polls the output folder of the processor. Finally, granting read/write access to your hot folder negates the security functions.

11.2.2 HTTP-Based Protocol (JDF + JMF)

HTTP ▶ [RFC2616] is a stable, vendor-independent protocol, and it supports a variety of advantageous features. For example, it offers a wide availability of tools. It is already a common technology among vendors who use HTTP, and it has a well defined query-response mechanism (HTTP post message). It also offers widespread firewall support and secure connections via SSL (see ▶ [SSL3]) when using HTTPS.

11.2.2.1 Protocol Implementation Details

JDF messaging does not specify a standard port.

Implementation of Messages

Only HTTP servers SHALL be targeted by [Query](#) messages, [Registration](#) messages or [Command](#) messages. This is done with a standard HTTP Post request. The JMF is the body of the HTTP post message. The [Response](#) message is the body of the response to the initiated HTTP post. [Signal](#) and [Acknowledge](#) messages are also implemented as HTTP post messages. The body of the HTTP response to these messages MAY be empty.

If reliable signaling (see ▶ Section 5.2.3 Signal) is implemented, the [Response](#) to a [Signal](#) SHALL NOT be empty.

HTTP Push Mechanisms

Since HTTP is a stateless protocol, push mechanisms, such as regular status bar updates, are non-trivial when communicating with a client. Workarounds can, however, be implemented. For example, a client application that polls the server in regular intervals MAY be used.

11.2.3 HTTPS-Based Protocol – SSL with two-way authentication

New in JDF 1.3

11.2.3.1 Purpose

The addition of support for the HTTPS protocol for use in JMF systems from JDF specification version 1.3 onwards is not so much about encryption as it is about authentication. Customers of JMF based system have a need to be able to exchange messages securely between systems in their facility without fear of intervention from outside sources or from malicious acts. The solution needs to be able to sustain authentication without having to exchange username and pass-

word on every call, is independent of platform and implementation language, and is capable of working across firewalls (though configuration of firewalls might be required in an individual installation).

Support for **JMF** over HTTPS does not require the implementation of any additional **JMF** messages, though the **RequestForAuthentication** message (which is new in 1.4) may be used to exchange certificates and establish a secure connection.

On a web server, the server provides its certificate to you. The client decides whether to accept communication. With two-way authentication client authentication is required.

11.2.3.2 Certificates

JMF over HTTPS requires both parties to provide exchange and validate certificates. The certificates SHALL contain the core four fields of the X.509 format and the UserID. Any additional fields are OPTIONAL. These fields are:

- Common Name (Abbreviation CN) (i.e., hostname which could be an IP address or DNS name by which the receiver knows the sender),
- Organization Unit (Abbreviation OU)
- Organization (Abbreviation O)
- Country (Abbreviation C)
- UserID (Abbreviation UID) - this SHALL be the SenderID by which the sender's messages will be identified by. This would be the client's SenderID for commands, queries, and signals, and the server's SenderID for responses and acknowledges
- givenName? - The vendor name, product name, and any other information about the product MAY be optionally included in the certificate using the givenName certificate field.

Example for XYZ Software's XYZImpose product:

```
CN=impose7.printinginc.internal OU=Prepress O=Printing, Inc.
C=US UID=XYZImpose7 givenName=XYZ Software XYZImpose v7.0
```

For more information, see ▶ [RSA Labs].

Certificates can be generated by any certificate generation tool, such as Sun Keytool. See ▶ Section 11.2.3.5.2 Example of Java Keytool Usage.

The certificates should be self-signed to remove the need to access third-party Certificate Authorities.

11.2.3.2.1 Verification of Certificates

Certificates should be verified against the hostname of the machine. They should therefore reference the machine and may need to be generated on site.

Note: The difference between the hostname and the IP address is that if the IP address changes, this will effectively revoke the certificate. However, if the hostname is used, then the name SHALL be resolvable by the receiver using either DNS or local name resolution.

11.2.3.3 Exchange of Certificates

Certificates may be exchanged and authenticated by the following sequence which makes use of the **RequestForAuthentication** message.

The **RequestForAuthentication** message includes a requirement that the recipient return its appropriate certificate on receipt of the sender's certificate, based on the value of the **@AuthenticationType** attribute.

The likely sequence of events between two parties, A and B, can be summarized as follows:

Figure 11-1: Example of exchange of certificates

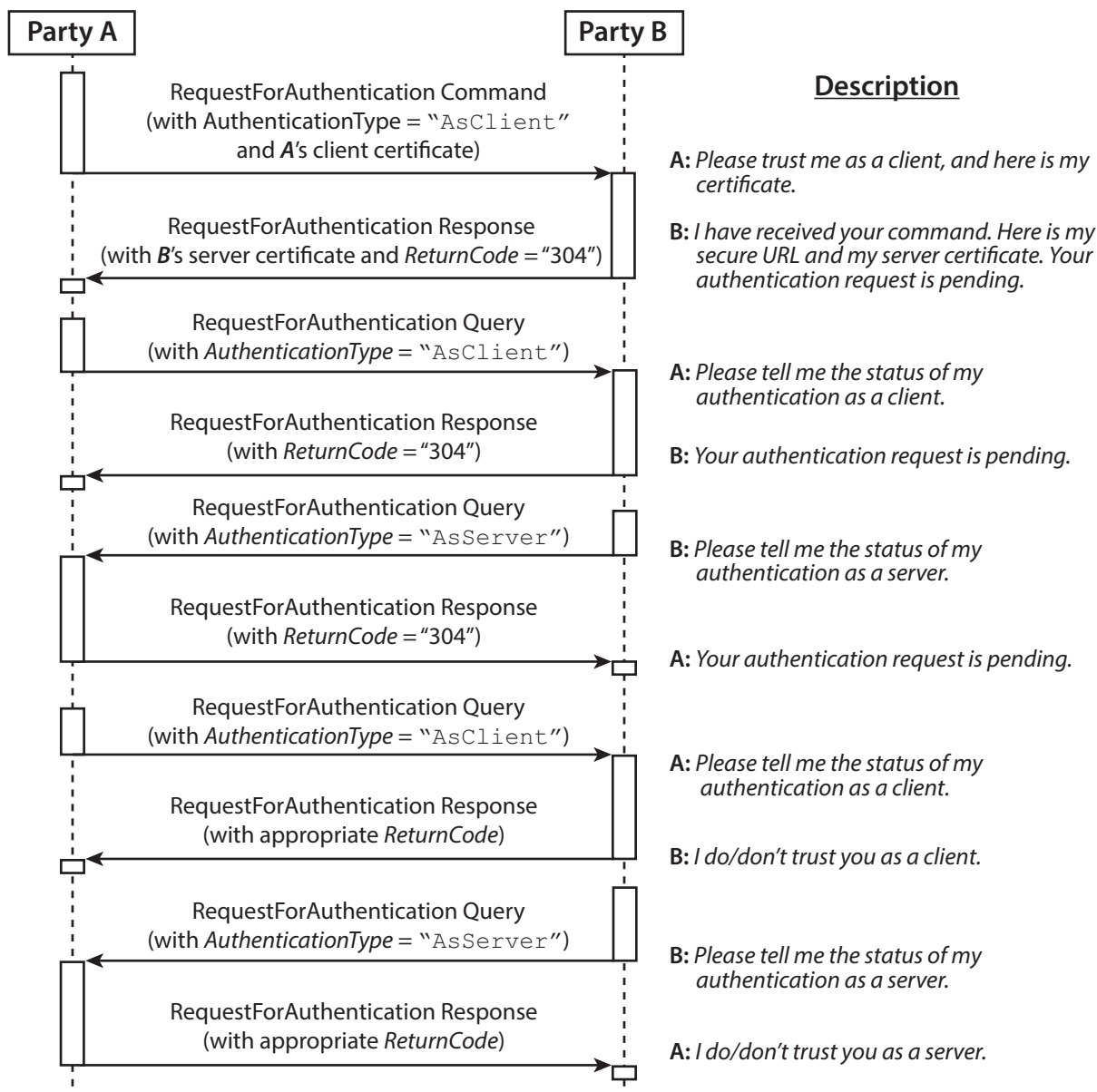

We now have 2 way authentication in one direction with A as the client, and B as the server. To complete the other direction, there are two possibilities:

- The process is repeated with B sending a **RequestForAuthentication** to A using the same steps.
- A to initiate the same steps, but sets the `@AuthenticationType` attribute to "AsServer", and provides its secure URL in the `AuthenticationCmdParams` element.

If the certificate received by A in the response from B is bad, then B's trust of A SHALL be manually deleted. Then A can repeat the above steps.

If the certificate received by A at some later time goes bad, then A can repeat the above steps over a secure channel, with the `@Reason` attribute set appropriately to indicate a problem. Effectively, it is saying, "I'm serving you notice that your certificate is bad; send me a new one". B's response will be to present a certificate that should be different to the one previously sent.

If party B realizes that it needs to re-issue its server certificate, it MAY send a **RequestForAuthentication** command to party A's secure URL, with the `@AuthenticationType` attribute set to "AsServer". A should then respond appropriately.

Reconnection: if certificates have been exchanged, but the secure URL has been lost, reconnection can be facilitated by sending a **KnownDevices** query to the system whose URL has been lost. If the signed certificate has been lost, then the existing trust relationships SHALL be manually deleted; the above steps should then be repeated.

11.2.3.4 Standards

See ▶ [SSL3] and ▶ [X.509].

11.2.3.5 Implementation

If a client communicates with a server over an HTTPS connection and at some point the client receives a “permission denied” HTTP response, this indicated that the secure connection has been revoked and that the client needs to resubmit the [RequestForAuthentication](#) message.

11.2.3.5.1 Discovery Messages

The [KnownDevices](#) message has been extended so that [Device](#) resource has a new attribute [@SecureJMFURL](#).

The [KnownMessages](#) message has been extended to indicate which messages are supported under which protocols, by adding the [@URLSchemes](#) attribute to the [MessageService](#) element.

11.2.3.5.2 Example of Java Keytool Usage

A command line example of using the Java keytool:

- 1 Use Java keytool to generate a public/private key pair and wrap the public key into an X.509 v1 self-signed certificate. The private key and certificate are stored in a JKS key store.

```
keytool -genkey -alias impose7 -dname "CN=xyzimpose7.myCompany.internal
OU=Prepress O=Printing, Inc. C=US UID=XYZImpose7
givenName=XYZ Software XYZImpose" -validity 365 -keystore keystore.jks
```

- 2 Export the self-signed certificate to the base64 encoded PEM format:

```
keytool -export -keystore keystore.jks -rfc -alias impose7 -file impose7.cer
```

For full documentation, see [▶ \[Java Keytool\]](#).

11.2.4 Managing Persistent Channels

A controller MAY request information about currently active subscriptions by sending a [KnownSubscriptions](#) query to a device. A controller SHOULD NOT send a new [Subscription](#) if a matching [Subscription](#) is already in place in the device. If the device does not support [KnownSubscriptions](#) query, the controller MAY create a new [Subscription](#). A device that receives a [Subscription](#) of the same type to the same URL SHOULD replace the existing [Subscription](#) with the new [Subscription](#).

A controller SHOULD remove persistent channels that are no longer evaluated by sending a [StopPersistentChannel](#) command to a device.

Persistent channels SHOULD be maintained, even when a device is powered off and powered on again.

11.2.5 Deleting Persistent Channels

A persistent channel SHALL be deleted by sending a [StopPersistentChannel](#) command message.

11.3 JDF Packaging

New in JDF 1.2

JDF messaging supports combining into a single package:

- the **JMF** message,
- the **JDF** job ticket(s) to which it refers, and
- the digital assets to which the **JDF** job tickets refer.

The following external data file types are identified, although any valid MIME file type MAY be referenced:

- Preview images (They SHOULD be encoded using the PNG format.)
- ICC Profiles
- Preflight Profiles
- PDL (Page Description Language)

Currently, MIME Multipart/Related packaging is supported. [▶ \[RFC2387\]](#)

All packaging methods use a consistent design pattern. The package contains one or more parts, and there SHALL be at least one **JDF** or **JMF** part. If a **JMF** part is included, there SHALL be only one. If the packaging has ordered parts (Multipart/Related) the **JMF** part SHALL be first. The **JDF** parts SHALL follow the **JMF** part (if present) and any other parts follow the **JDF** parts.

When the content parts of a **JDF** package are extracted, the [QueueSubmissionParams](#) (at a provided URL) or [ResubmissionParams](#) (at a provided URL) within the **JMF** message and [FileSpec](#) (at a provided URL) within the **JDF** ticket(s) SHALL be updated with the URL at which the referenced items are stored.

11.3.1 MIME Basics

MIME (Multipurpose Internet Mail Extensions) ▶ [RFC2045] is an Internet standard that defines mechanisms for specifying and describing the format of Internet message bodies. MIME is comprised of headers and content. In case of multipart messages, the content consists of multiple body parts, each with its own MIME headers and content. A unique boundary string precedes each body part and follows the last one.

11.3.2 MIME Types and File Extensions

The following MIME types and extensions SHOULD be used when storing **JDF** or **JMF** as files or when a MIME type is required, e.g. when setting the http Content-Type header.

Table 11.1: MIME Types and File Extensions

MIME TYPE	EXTENSION	USAGE
application/vnd.cip4-jdf+xml	jdf	Unpackaged JDF .
application/vnd.cip4-jmf+xml	jmf	Unpackaged JMF .

It is RECOMMENDED that the controller use a file extension of “jdf” when using file-based **JDF** in an environment that supports file name extensions. Agents that serialize **JMF** to a file SHOULD use a file extension of “jmf”.

When a MIME package containing **JDF** or **JMF** is serialized to a file, it is RECOMMENDED to use the “mjd” file extension for packages where a **JDF** is the first entity. It is RECOMMENDED to use the “mjm” file extension when a **JMF** message is the first package. CIP4 will also register a mime type for CIP3 ppf: application/vnd.cip3-ppf. It is RECOMMENDED that the controller use a file extension of “ppf” when writing CIP3 ppf files.

11.3.2.1 MIME Headers

New in JDF 1.2

This section defines the normative extensions when using MIME to package **JMF** or **JDF**.

11.3.2.1.1 Content-Type Header

This MIME header is REQUIRED for an individual **JDF** or **JMF**, the root, and the individual bodyparts of a MIME Multipart/Related package. “Content-Type” identifies the MIME type of the message or body part). The “Content-Type” header can identify a message as a MIME Multipart message and each body part also has a “Content-Type” header to identify its content. The following “Content-Type” are used with **JDF**:

Table 11.2: MIME Content-Types

MIME TYPE	DESCRIPTION
application/vnd.cip4-jdf+xml	A JDF file. The root XML element SHALL be JDF .
application/vnd.cip4-jmf+xml	A JMF file. The root XML element SHALL be JMF .
Multipart/Related	A package of a JDF or JMF file + optional additional referenced data ▶ [RFC2387]. The root XML element of the first bodypart SHALL be JDF or JMF .

11.3.2.1.2 Content-ID Header

This field is REQUIRED for every body part that is referenced from another body part in a Multipart/Related message. “Content-ID” identifies each different body part within a MIME Multipart message. Its value SHALL be an Email address as long as it is defined using US-ASCII. Each value of “Content-ID” SHALL be unique within the message, but it need not be a working Email address. Thus “Content-ID” can be a somewhat random sequence and need not be related to the original filename. It is good practice to limit yourself to using only alphanumeric characters, or only the first 127 characters of the US-ASCII character set in order to avoid confusing less intelligent MIME agents.

11.3.2.1.3 Content-Transfer-Encoding

This field is OPTIONAL. ▶ [RFC2045]. It defines the following varying encodings:

- “7bit”
- “quoted-printable”
- “base64”

- **"8bit"**: This specifies that no additional encoding is applied to the data. Use **"8bit"** if the **JDF** stream contains CR or LF separators (e.g., for body parts containing **JDF** or **JMF**).
- **"binary"**: This specifies that no additional encoding is applied to the data. Use **"binary"** if there is no CR or LF separators in the stream (e.g., for body parts containing JPEG).

Private encodings MAY be defined and begin with the prefix **"X-"**. When no encoding is used, the data are only encapsulated by MIME headers. **"base64"** and **"quoted-printable"** encodings are commonly used algorithms for converting eight-bit and binary data into seven-bit data and vice versa. Consumers that support MIME SHOULD support **"8bit"** and **"binary"** and SHALL support **"base64"**. The other encodings are OPTIONAL.

It is RECOMMENDED to also specify the encoding for the **JDF/JMF** parts of a Multipart/Related package.

11.3.2.1.4 Content-Disposition Header

This field is OPTIONAL. See ▶ [RFC2231] It allows a filename to be specified for a body part. The **"Disposition-Type"** SHALL be set to **"attachment"**.

The Disposition filename parameter contains a suggested file name for storing the attachment. This file name MAY be the original file name when creating the MIME file and can be visible to the operator.

Note: The filename is a value that needs special MIME encoding rules, these are ▶ [RFC5322] and ▶ [RFC2231].

It is RECOMMENDED to use quoted-strings for file names with only US-ASCII characters see ▶ [RFC5322] and ▶ [RFC2231] for file names with non-USASCII characters.

Example for ▶ [RFC5322]:

A name=**"Cover page.pdf"** becomes:

```
Content-Disposition: attachment; filename="Cover page.pdf";
```

Example for ▶ [RFC2231]:

A name=**"Dollar€_1.pdf"** becomes:

```
Content-Disposition: Attachment; filename*=UTF-8'"Dollar%E2%82%AC_1.pdf";
```

Example 11.1: Packaging of Individual JDF/JMF files in MIME

New in JDF 1.2

The following example displays MIME packaging of a **JDF** file as an individual MIME object:

```
MIME-Version: 1.0
Content-Type: multipart/related; boundary=abcdefg0123456789
Content-Transfer-Encoding: 8bit
--abcdefg0123456789
Content-Type: application/vnd.cip4-jdf+xml
<JDF ... >
  <PreviewImage Separation="PANTONE 128" URL="cid:123456.png" />
</JDF>
--abcdefg0123456789
```

11.3.2.2 CID URL Scheme

New in JDF 1.2

One of the benefits of the MIME Multipart/Related **@MediaType** is the ability of a URL in one body part to refer to the content of another body part. This is done by using a **"cid"** scheme in a URL, specified in ▶ [RFC2392]. Please look at the example to see how it is used.

Example 11.2: CID URL Scheme

```
MIME-Version: 1.0
Content-Type: multipart/related; boundary=abcdefg0123456789
Content-Transfer-Encoding: 8bit
--abcdefg0123456789
Content-Type: application/vnd.cip4-jdf+xml
<JDF ... >
  <PreviewImage Separation="PANTONE 128" URL="cid:123456.png@cip4.org" />
</JDF>
--abcdefg0123456789
Content-Type: image/png
Content-Transfer-Encoding: base64
Content-ID: <cid:123456.png@cip4.org>

BASE64DATA
BASE64DATA

--abcdefg0123456789
```

Note: ▶ [RFC2392] requires that the value of the Content-ID be enclosed in angle brackets (<>). Characters that ▶ [RFC2392] permits for Content-ID include characters that ▶ [RFC3986] does not permit for URLs. Any such character, e.g. "+" or "&", SHALL be hex-encoded using the %hh escape mechanism in the URL, see ▶ [RFC3986]. Therefore, matching the cid URL with the Content-ID SHALL take account of the escaped equivalences. In addition, case-insensitive matching SHALL be used.

11.3.2.3 Ordering of Body Parts in MIME Multipart/Related

New in JDF 1.2

The first body part of the MIME Multipart message SHALL be the **JMF** message. Internal links are defined using the cid URL and a corresponding Content-ID MIME header. Subsequent sections contain the **JDF** job followed by linked entities, such as the preview images shown in the following example:

Example 11.3: MIME Multipart/Related

A Multipart/Related message is received that contains:

- Message.jmf
- Ticket01.jdf
- Pages.pdf

```
MIME-Version: 1.0
Content-Type: mulitpart/related; boundary=unique-boundary

--unique-boundary
Content-Type: application/vnd.cip4-jmf+xml
Content-Transfer-Encoding: 8bit

<?xml version="1.0" encoding="UTF-8"?>
<JMF SenderID="JMFCClient" TimeStamp="2016-07-07T13:15:56+01:00"
  Version="1.6" xmlns="http://www.CIP4.org/JDFSchema_1_1" xmlns:xsi="http://www.w3.org/2001/
XMLSchema-instance">
  <Command ID="C0001" Type="SubmitQueueEntry" xsi:type="CommandSubmitQueueEntry">
    <QueueSubmissionParams Hold="true" URL="cid:JDF1@hostname.com"/>
  </Command>
</JMF>

--unique-boundary
Content-Type: application/vnd.cip4-jdf+xml
Content-Transfer-Encoding: 8bit
Content-ID: <JDF1@hostname.com>
Content-Disposition: attachment; filename="Ticket01.jdf";
```

```

<?xml version="1.0" encoding="UTF-8"?>
<JDF Activation="Active" ID="JDF_c" JobID="Job1" JobPartID="345"
  Status="Waiting" Type="Product" Version="1.6" xmlns="http://www.CIP4.org/JDFSchema_1_1">
  <JDF ID="JDF-3" JobPartID="400" Status="Waiting" Type="DigitalPrinting">
    <ResourceLinkPool>
      <DigitalPrintingParamsLink Usage="Input" rRef="ID123"/>
      <RunListLink Usage="Input" rRef="RunList4"/>
      <ComponentLink Amount="3" Usage="Output" rRef="ID125"/>
    </ResourceLinkPool>
    <ResourcePool>
      <DigitalPrintingParams Class="Parameter" ID="ID123" Status="Available"/>
    </ResourcePool>
  </JDF>
  <ResourceLinkPool>
    <ComponentLink Amount="3" Usage="Output" rRef="ID125"/>
  </ResourceLinkPool>
  <ResourcePool>
    <Component Class="Quantity" ComponentType="Sheet" ID="ID125" Status="Unavailable"/>
    <RunList Class="Parameter" ID="RunList4" Status="Available">
      <LayoutElement ElementType="Document" HasBleeds="false" IsPrintable="true">
        <FileSpec URL="cid:Asset01@hostname.com" UserFileName="Christmas Cards"/>
      </LayoutElement>
    </RunList>
  </ResourcePool>
</JDF>

```

```

--unique-boundary
Content-Type: application/pdf
Content-ID: <Asset01@hostname.com>
Content-Transfer-Encoding: binary
Content-Disposition: attachment; filename="Pages 1.pdf";

```

```

The pdf goes in here.
--unique-boundary

```

When such a stream arrives at the server, it is decoded and the parts stored locally, either in memory or persistent storage. The contents of the stream are extracted. The designer of the controller chose to save package contents into a uniquely named directory.

- Assets are saved first — Pages.pdf is placed in /root/temp/a39e9503-a96b-4e86-9c1d-f4188d19810e/Assets/
- The controller then internally maps cid:Asset01@hostname.com in the ticket into file:///root/temp/a39e9503-a96b-4e86-9c1d-f4188d19810e/Assets/Pages.pdf.
- Then Ticket01.jdf is placed in the directory /root/temp/a39e9503-a96b-4e86-9c1d-f4188d19810e/
- The controller then internally maps cid:JDF1@hostname.com in the message into file:///root/temp/a39e9503-a96b-4e86-9c1d-f4188d19810e/Ticket01.jdf and either executes or stores the message.

11.4 MIS Requirements

MIS systems MAY:

- Ignore **Audit** elements if they receive complete information about a process execution via **JMF**.
- Decompose **JDF** into an internal format such as database tables.

11.5 Interoperability Conformance Specifications

Interoperability Conformance Specifications (i.e., ICS documents) are developed by CIP4 working committees. They establish the minimum **JDF** support requirements for devices of a common class, including expected behavior. An ICS document can subset **JDF** but can not expand upon **JDF**. For instance, an ICS that covers desktop printers can either omit or prohibit all of the postpress processes related to case binding. ICS documents can also establish minimum **JDF** support requirements for a class of devices.

Once published, ICS documents will form the basis for testing and certification by CIP4-sanctioned facilities. **JDF** enabled products that pass these tests will be deemed “JDF Certified” to conform to an identified level of one or more ICS documents, and will be permitted upon certification to use a “JDF Certified” logo in connection with certified **JDF** enabled products.

The development of ICS documents are done in parallel, but not in synchronization, with the development of editions of the **JDF** specification (e.g., an ICS is related to a specific edition of the **JDF** Specification, but might be released at a later date). Once approved, all published ICS documents will be available at http://www.cip4.org/document_archive/ics.php.

Appendix A

A Data Types and Values

This appendix lists the **JDF** data types and describes how they are encoded in XML. Data types are simple data entities such as strings, numbers (as doubles) and dates. They have a very straightforward string representation and are used as XML attribute values. Data structures are derived from these types and describe more complex structures, such as colors. The appendix also contains commonly used closed list enumerations, e.g. ▶ Activation, and preferred values for open lists of NMTOKEN or strings, e.g. ▶ Contact Types.

A.1 Notes About Encoding

All of the **JDF** types are derived from XML schema types either by extension, use of lists, or by restriction. Each type will refer back, either directly or indirectly, to such a type. Here, reference ought to be made to “XML Schema Part 2 – Data-types” ▶ [XMLSchema].

A.1.1 List, Range and Range List Data Types

Some data types are derived from a base type that represents a single value. Such data types include a list, a range and a range list. For a data type X, the name of such data types are XList, XRange and XRangeList, respectively. Each data type represents a set of values of the base data type. A list is an enumerated set of values, which is expressed as a list of space separated values. A range is a continuous inclusive range of values, which is expressed as a pair of values separated by a ‘~’ character. A range list is a set of values that includes range values and may also include individual values. A range list is expressed as a list of space separated ranges and individual values. Some data types with a range and range list data types do not have a list data type. In this case, the range list may allow only range values.

A.1.2 Whitespace

The addition of whitespace characters for single types is NOT RECOMMENDED. Items in a list of values are separated by whitespace. A range consists of two items separated by a '~'; although not mandatory (to maintain compatibility with **JDF** 1.1), it is strongly RECOMMENDED that whitespace is used between the items and the '~'.

Note: The **JDF** 1.2 schema will only correctly validate ranges if whitespace is used around the '~'.

A.1.3 Infinity Limits

Several types require the ability to set an unbounded range, or to select a single terminating value (e.g., integer or date ranges). These types have been extended with the tokens “-INF” or “INF” to indicate the maximum negative and positive limits of the values in question, details are shown where appropriate for each value.

A.2 Simple Types — Attribute Values

A.2.1 boolean

Has the value space for supporting the mathematical concept of binary-valued logic:

Encoding

Values of type boolean are encoded as either of the string values “true” or “false”. The XML schema data type boolean values of “1” or “0” are not permitted.

Example A.1: boolean

```
<Example Enable="true"/>
```

A.2.2 CMYKColor

XML attributes of type CMYKColor are used to specify CMYK colors.

Encoding

Values of type CMYKColor attributes are primitive data types and are encoded as a list of four numbers (as doubles) in the range of [0...1.0] separated by whitespace. A value of 0.0 specifies no ink and a value of 1.0 specifies full ink. The sequence of colors is “C M Y K”.

Example A.2: CMYKColor

```
<Color CMYK="0.3 0.6 0.8 0.1"/><!-- brick red -->
```

A.2.3 date

Deprecated in JDF 1.6

A.2.4 dateTime

Represents a specific instant of time. It SHALL be a Coordinated Universal Time (UTC) or the time zone SHALL be indicated by the offset to UTC. In other words, the time SHALL be unique in all time zones around the world. It also allows infinity limits as a means of permitting explicit ‘don’t care’ values (i.e., it SHALL be finished before ‘anytime’).

Encoding

Values of type dateTime are represented as a union of the XML schema type: *dateTime* and the infinity value tokens *INF* and *-INF*.

Note: That ▶ [ISO8601:2004] allows a wider range of time zone specifications than XML. *dateTime* SHALL adhere to the stricter limitations defined in ▶ [XMLSchema]. For instance, the colon ‘:’ in the time zone field SHALL be present when writing time zones in the format "hh:mm".

Example A.3: dateTime

```
<Example Start="1999-05-31T18:20:00Z"/>
<Example Start="1999-05-31T13:20:00-05:00"/>
```

A.2.5 DateTimeRange

New in JDF 1.2

XML attributes of type DateTimeRange are used to describe a range of points in time. More specifically, it describes a time span that has an absolute start and end. Unbounded ranges can use the infinity value tokens *INF* and *-INF*

Encoding

A DateTimeRange is represented by two dateTime or infinity tokens, separated by the whitespace “~” whitespace sequence.

Example A.4: DateTimeRange

```
<Example range="1999-05-31T18:20:00Z ~ 1999-05-31T18:20:00Z"/>
<Example range="1999-05-31T18:20:00Z ~ INF"/>
<Example range="-INF ~ 1999-05-31T18:20:00Z"/>
```

A.2.6 DateTimeRangeList

New in JDF 1.2

XML attributes of type DateTimeRangeList are used to describe a list of ranges of points in time. More specifically, it describes a list of time spans, which each have a relative start and end.

Encoding

A DateTimeRangeList is represented by sequence of either DateTimeRange values (See 1.5), separated by whitespace or dateTime values.

Example A.5: DateTimeRangeList

```
<Example RangeList="1999-05-31T18:20:00Z ~ 1999-05-31T18:20:00Z 1999-05-31T13:20:00-05:00 ~ INF"/>
```

A.2.7 double

Values of type double correspond to IEEE double-precision 64-bit floating point type. It includes the infinity limit tokens *INF* and *-INF*, but does not allow the “Not a Number” token *NaN*.

Encoding

It is similar to the XML schema type: *double* representation. However, the string value *NaN*, is not permitted.

Example A.6: double

```
<Example NegativePi="-3.14159"/>
```

A.2.8 DoubleList

New in JDF 1.2

Values of type DoubleList are used to describe a variable length list of numbers (as doubles). This type is used as the base for other **JDF** types that use a fixed length list of number (e.g., CMYKColor which is restricted to four number in the list).

Encoding

A DoubleList is encoded as a string of whitespace-separated double values as defined in ▶ Section A.2.7 double.

Example A.7: DoubleList

```
<Example MinustoPlus2Pi="-3.14159 6.28318"/>
```

A.2.9 DoubleRange

New in JDF 1.2

XML attributes of type DoubleRange are used to describe a range of numbers (as doubles). Mathematically speaking, the two numbers define a closed interval.

Encoding

A DoubleRange is represented by two double values separated by a “~” (tilde) character and OPTIONAL additional whitespace.

Note: It is now RECOMMENDED that the ‘~’ be surrounded by whitespace to aid validation and parsing.

Example A.8: DoubleRange

```
<Example range="-3.14 ~ 5.13"/>
<Example range="0 ~ INF"/>
```

A.2.10 DoubleRangeList

New in JDF 1.2

XML attributes of type DoubleRangeList are used to describe a list of DoubleRange values and/or enumerated numbers as doubles).

Encoding

A DoubleRangeList is a sequence of DoubleRange values and single double values separated by whitespace.

Example A.9: DoubleRangeList

```
<Example list="-1 ~ -6 3.14 ~ 5.13 7 9 ~ 128 131 255 ~ INF"/>
```

A.2.11 duration

Values of type duration represent a period of time. Based on ▶ [ISO8601:2004]. The single infinity limit token *INF* is permitted.

Encoding

It is represented as a union of the XML schema type: "duration" and the string value "INF"

Note: That ▶ [XMLSchema] explicitly allows negative durations. Thus a value of -PT15M is valid and describes a negative duration of 15 minutes in the past.

Example A.10: duration

```
<Example Duration="P1Y2M3DT10H30M"/>
```

A.2.12 DurationRange

XML attributes of type DurationRange are used to describe a range of time durations. More specifically, it describes a time span that has a relative start and end.

Encoding

A DurationRange is represented by two duration values, separated by the “~” (tilde) space character and optional additional whitespace.

Note: It is now RECOMMENDED that the ‘~’ be surrounded by whitespace to aid validation and parsing.

Example A.11: DurationRange

```
<Example range="P1Y2M3DT10H30M ~ P1Y2M3DT10H35M"/>
<Example range="P1Y2M3DT10H30M ~ INF"/>
```

A.2.13 DurationRangeList

New in JDF 1.2

XML attributes of type DurationRangeList are used to describe a list of ranges of time durations. More specifically, it describes a list of time spans that have a relative start and end.

Encoding:

A DurationRangeList is represented by sequence of DurationRange values and durations, separated by whitespace.

Example A.12: DurationRangeList

```
<Example RangeList="P1Y2M3DT10H30M ~ P1Y2M3DT10H35M P1Y3M2DT10H30M"/>
```

A.2.14 gYearMonth

Deprecated in JDF 1.6

A.2.15 hexBinary

Values of type hexBinary represents arbitrary hex encoded binary data.

Encoding

It is represented as being identical to the XML schema type: *hexBinary*

Example A.13: hexBinary

```
<Example Hex="0A1C"/>
```

A.2.16 ID

Modified in JDF 1.3

Represents the *@ID* attribute from ▶ [XMLSchema]. It represents a name or string that contains no space characters and begins with a letter, or ‘_’. Each ID value SHALL be unique within a **JDF** document and thus uniquely identify the elements that bear them.

Note: that the *@ID* attribute definition in ▶ [XMLSchema] is more restrictive than the *@ID* attribute definition in ▶ [XML]. ▶ [XMLSchema] explicitly forbids the use of ‘:’ in ID.

Encoding

It is represented as being identical to the XML schema type: *ID*

Example A.14: ID

```
<Example ID="R-16"/>
```

A.2.17 IDREF

IDREF represents the IDREF attribute from ▶ [XMLSchema]. For a valid XML-document, an element with the ID value specified in IDREF SHALL be present in the scope of the document.

Encoding

It is represented as being identical to the XML schema type: *IDREF*

Example A.15: IDREF

```
<Example IDREF="R-16"/>
```

A.2.18 IDREFS

IDREFS represents the IDREFS attribute from ▶ [XMLSchema]. More specifically, this is a whitespace-separated list of IDREF values.

Encoding

It is represented as being identical to the XML schema type: *IDREFS*

Example A.16: IDREFS

```
<Example IDREFS="R-12 R-16"/>
```

A.2.19 integer

Represents numerical integer values with tokens for representing infinity limits.

Implementation note: Except where explicitly noted otherwise, integers are not expected to exceed a value that can be represented as signed 32 bits.

Encoding

It is represented as a union of the XML schema type: *integer* and the infinity value tokens *INF* and *-INF*

Example A.17: integer

```
<Example Copies="36"/>
```

A.2.20 IntegerList

XML attributes of type *IntegerList* are used to describe a variable length list of integer values.

Encoding

An *IntegerList* is encoded as a string of integers separated by whitespace.

Example A.18: IntegerList

```
<XXX list="-INF 0 1 2 3 4 INF 1 3 0"/>
```

A.2.21 IntegerRange

XML attributes of type *IntegerRange* are used to describe a range of integers. In some cases, ranges are defined for an unknown number of objects. In these cases, a negative value denotes a number counted from the end. For example, -1 is the last object, -2 the second to last and so on. *IntegerRanges* that follow this convention are marked in the respective attribute descriptions.

If the first element of an *IntegerRange* specifies an element that is behind the second element, the range specifies a list of integers in reverse order, counting backwards. For example "6 ~ 4" = "6 5 4" and "-1 ~ 0" = "last... 2 1 0".

Encoding

An *IntegerRange* is represented by two integers, separated by a “~” (tilde) character and optional additional whitespace.

Note: It is now RECOMMENDED that the ‘~’ be surrounded by whitespace to aid validation and parsing.

Example A.19: IntegerRange

```
<RunList ID="RL1" Class="Parameter" Status="Available" Pages="-3 -5"/>
<RunList ID="RL2" Class="Parameter" Status="Available" Pages="INF -5"/>
```

A.2.22 IntegerRangeList

XML attributes of type *IntegerRangeList* are used to describe a list of *IntegerRanges* and/or enumerated integers.

Encoding

An *IntegerRangeList* is represented by a sequence of *IntegerRanges* and integers, separated by whitespace.

Example A.20: IntegerRangeList

```
<Example list="-1 ~ -6 3 ~ 5 7 9 ~ 128 131"/>
```

A.2.23 LabColor

Values of type LabColor are used to specify absolute Lab colors. The Lab values are normalized to a light of D50 and an angle of 2 degrees as specified in ▶[CIE 015:2004] and ▶[ISO13655:2017].

This corresponds to a white point of X = 0.9642, Y = 1.0000 and Z = 0.8249 in CIEXYZ color space. The value of L is restricted to a range of [0..100]; a and b are unbounded.

Encoding

LabColors are primitive data types and are encoded as a list of three numbers (as doubles) separated by whitespace in the sequence: “L a b”

Example A.21: LabColor

```
<Color Lab="51.9 12.6 -18.9"/>
```

A.2.24 language

Values of type language represent a natural language defined in ▶[RFC3066].

Encoding

It is represented as being identical to the XML schema type: *language*

Example A.22: language

```
<Example Language="de"/> <!-- German -->
<Example Language="de-CH"/> <!-- Swiss German -->
<Example Language="en"/> <!-- English -->
<Example Language="en-GB"/> <!-- British English -->
```

A.2.25 languages

New in JDF 1.4

Values of type languages represent a list of natural languages, each defined in ▶[RFC3066].

Encoding

A languages value is encoded as a string of languages, each language separated by whitespace.

Example A.23: languages

```
<Example Languages="de-CH de en-GB en"/>
```

A.2.26 matrix

Coordinate transformation matrices are widely used throughout the whole printing process, especially in **Layout** resources. They represent two dimensional transformations as defined by ▶[PostScript] and ▶[PDF1.6]. For more information, refer to the respective reference manuals, and look for “Coordinate Systems and Transformations.” The “identity matrix”, which is “1 0 0 1 0 0”, is often used as a default throughout this specification. When another matrix is factored against a matrix with the identity matrix value, the result is that the original matrix remains unchanged.

Encoding

Coordinate transformation matrices are primitive data types and are encoded as a list of six numbers (as doubles), separated by whitespace: “a b c d Tx Ty”. The variables Tx and Ty describe distances and are defined in points.

Example A.24: matrix

```
<ContentObject CTM="1 0 0 1 3.14 21631.3"/>
```

A.2.27 NameRange

XML attributes of type NameRange are used to describe a range of NMTOKEN data that are acquired from a list of named elements, such as named pages in a PDL file. It depends on the ordering of the targeted list, which names are assumed to be included in the NameRange. The following two possibilities exist:

- 1 There is no explicit ordering. In this case, case sensitive alphabetical ordering ▶ [Unicode5.0.0] is implied. This behavior is the default unless called out explicitly in the specification.
- 2 There is explicit ordering, such as in a list of named pages in a *RunList*. In this case, the ordering of the *RunList* defines the order and all pages between the end pages are included in the NameRange.

Modification note: Starting with **JDF 1.4**, the first item is specified as the default behavior.

Encoding

A NameRange typed attribute is represented by two NMTOKEN values separated by a “~” (tilde) character and optional additional whitespace.

Note: It is now RECOMMENDED that the ‘~’ be surrounded by whitespace to aid validation and parsing.

Example A.25: NameRange

```
<Example NameRange="Jack ~ Jill"/>
```

A.2.28 NameRangeList

XML attributes of type NameRangeList are used to describe a list of NameRanges.

Encoding

A NameRangeList is represented by a sequence of NameRanges and NMTOKEN, separated by whitespace.

Example A.26: NameRangeList

```
<Example list="A brian ~ fred x z"/>
```

A.2.29 NMTOKEN

Values of type NMTOKEN represent a name or string that contains no space characters.

Note: NMTOKEN values MAY begin with any non whitespace character, including numerical characters.

Encoding

It is represented as being identical to the XML schema type: *NMTOKEN*.

Example A.27: NMTOKEN

```
<Example Alias="ABC_6"/>
```

A.2.30 NMTOKENS

Represents the NMTOKENS attribute type from ▶ [XML]. More specifically, this is a whitespace-separated list of NMTOKEN values.

Encoding

It is represented as being identical to the XML schema type: *NMTOKENS*

Example A.28: NMTOKENS

```
<Example AliasList="ABC_6 ABCD_3 DEGF"/>
```

A.2.31 PDFPath

Modified in JDF 1.3

Values of type PDFPath are used in **JDF** for describing parameters such as trap zones and clip paths. In PJTF, PDFPaths are encoded as a series of **moveto–lineto** operations. **JDF** has a different encoding, which is able to describe more complex paths, such as Bezier curves. The non-zero winding rule is used to fill closed paths.

Encoding

PDFPaths are encoded by restricting an XML *string* attribute formatted with PDF path operators. This allows for easy adoption in PS and PDF workflows. PDF operators are limited to those described in “Path Construction Operators” in ▶ [PDF1.6].

Example A.29: PDFPath

```
<ElementWithPath path="0 0 m 10 10 1 20 20 1"/>
```

A.2.32 rectangle

Values of type `rectangle` are used to describe rectangular locations on the page, sheet or other printable surface. A rectangle is represented as a list of four numbers — `llx lly urx ury` — specifying the lower-left x, lower-left y, upper-right x and upper-right y coordinates of the rectangle, in that order. This is equivalent to the ordering: Left Bottom Right Top.

Encoding

To maintain compatibility with PJTF, rectangles are primitive data types and are encoded as a string of four *numbers*, separated by whitespace: `"llx lly urx ury"` or `"l b r t"`.

Example A.30: rectangle

```
<ContentObject ClipBox="0 0 3.14 21631.3"/>
```

Implementation Remark

Since all numbers are real numbers, any comparison of boxes SHOULD take into account certain rounding errors. For example, different XYPair values MAY be considered equal when all numbers are the same within a range of 1 point.

A.2.33 RectangleRange

New in JDF 1.2

XML attributes of type `RectangleRange` are used to describe a range of rectangles.

Encoding

A `RectangleRange` is represented by one or two rectangles, separated by a “~” (tilde) character and optional additional whitespace.

Note: It is now RECOMMENDED that the ‘~’ be surrounded by whitespace to aid validation and parsing.

Example A.31: RectangleRange

```
<Example range="1 2 3 4 ~ 5 6 7 8"/>  
<Example range="-INF -INF 3 4 ~ 0 1 INF INF"/>
```

A.2.34 RectangleRangeList

New in JDF 1.2

XML attributes of type `RectangleRangeList` are used to describe a list of rectangle ranges.

Encoding

A `RectangleRangeList` is represented by sequence of `RectangleRange` values and rectangle values, separated by whitespace.

Example A.32: RectangleRangeList

```
<Example RectangleRangeList="1 2 3 4 ~ 5 6 7 8 9 10 11 12 13 14 15 16"/>
```

A.2.35 regExp

Values of type `regExp` represent a regular expression as defined in ▶ [XMLSchema].

Encoding

It is represented as being identical to the XML schema type: *normalizedString*

Example A.33: `regExp`

```
<Example expression="Foo(1|2*)" />
```

A.2.36 `shape`

Values of type `shape` are used to describe a three dimensional box.

Encoding

A `shape` is represented as an array of three (positive or zero) *numbers* — `x y z` — specifying the width `x`, height `y` and depth `z` coordinates of the shape, in that order.

Example A.34: `shape`

```
<Example Dimensions="10 20 40" />
```

A.2.37 `ShapeRange`

XML attributes of type `ShapeRange` are used to describe a range of shapes (three dimensional boxes). The range "`x1 y1 z1 ~ x2 y2 z2`" describes the area `x1 <= x <= x2` and `y1 <= y <= y2` and `z1 <= z <= z2`. Thus the shape "`2 3 4`" is within "`1 2 1 ~ 3 4 4`".

Note that this implies that all three values of the second entry SHALL be `>=` the corresponding values of the first entry. The following example is therefore invalid: "`1 2 1 ~ 0 4 4`".

Encoding

A `ShapeRange` is represented by two shapes, separated by a “~” (tilde) character and optional additional whitespace.

Note: It is now RECOMMENDED that the ‘~’ be surrounded by whitespace to aid validation and parsing.

Example A.35: `ShapeRange`

```
<Example Shaperange="1 2 3 ~ 4 5 6" />
<Example Shaperange="1 2 3 ~ 4 INF 6" />
```

A.2.38 `ShapeRangeList`

XML attributes of type `ShapeRangeList` are used to describe a list of `ShapeRange` and/or shapes.

Encoding

A `ShapeRangeList` is a sequence of `ShapeRange` and shapes separated by whitespace.

Example A.36: `ShapeRangeList`

The brackets below the example illustrate the grouping of shapes and `ShapeRange` values.

```
<Example Shapelist="100 200 300 ~ 110 220 330 150 300 150 2 3 0 ~ 3 4 5" />
<!-- grouping      [                ] [                ] [                ] -->
```

A.2.39 `sRGBColor`

XML attributes of type `sRGBColors` are used to specify sRGB colors.

Encoding

`sRGBColors` are primitive data types and are encoded as a string of three numbers in the range of [0...1.0] separated by whitespace. A value of 0 specifies no intensity (black) and a value of 1 specifies full intensity. The sequence is defined as: “`r g b`”

Example A.37: `sRGBColor`

```
<Color sRGB="0.3 0.6 0.8" />
```

A.2.40 `string`

Values of type `string` represents sequences of characters.

Encoding

It is represented as being identical to the XML schema type: *normalisedString*.

Example A.38: string

```
<Example Name="Test With Space"/>
```

A.2.41 TimeRange

Deprecated in JDF 1.2

A.2.42 TransferFunction

Values of type TransferFunction are functions that have a one-dimensional input and output. In **JDF**, they are encoded as a simple kind of sampled functions and used to describe transfer curves of image transfer processes from one medium to the next (e.g., film to plate, or plate to press).

A transfer curve consists of a series of XY pairs where each pair consist of the stimuli (X) and the resulting value (Y). To calculate the result of a certain stimuli, the following algorithms SHALL be applied:

- 1 If $x \leq$ first stimuli, then the result is the y value of the first xy pair.
- 2 If $x \geq$ the last stimuli, then the result is the y value of the last xy pair.
- 3 Search the interval in which x is located.
- 4 Return the linear interpolated value of x within that interval.

Encoding

A TransferCurve is encoded as a string of space-separated *numbers* (as doubles). The numbers are the XY pairs that build up the transfer curve.

Note: The end points of a TransferFunction SHALL be explicitly specified and are **NOT** defaulted to "0 0" or "1 1".

Example A.39: TransferFunction

```
<someElementWithTransferCurve someCurve="0 0 .1 .105 .2 .21 .3 .305 .5 .5 .8 .8 .9 .9 1 1"/>
```

A.2.43 URI

Modified in JDF 1.3

Values of type URI represent a Uniform Resource Identifier (URI) Reference as defined in ▶ [RFC3986]. In **JDF** 1.3 and above, the URI data typed is represented as an Internationalized Resource Identifier (IRI) as defined in ▶ [RFC3987].

Encoding

A URI is represented as being identical to the XML schema type: *anyURI*.

Example A.40: URI

```
<Example URI="http://www.w3.org/1999/XMLSchema"/>
```

A.2.44 URL

Short for URL-reference. Represents a Uniform Resource Locator (URL) Reference as defined in ▶ [RFC3986]. In **JDF** 1.3 and above, the URL data typed is represented as an Internationalized Resource Identifier (IRI) as defined in ▶ [RFC3987].

Encoding

A URL is represented as being identical to the XML schema type: *anyURI*.

Note: Some characters in a URL SHALL be escaped and all characters MAY be escaped by encoding their UTF-8 representation into a '%' followed by the double digit hex representation of the character. The list of characters that SHALL be encoded is dependent on the URL scheme. Non-escaped characters SHALL be encoded in the encoding of the containing **JDF** document.

Example A.41: URL

New in JDF 1.4

A UNC path to be displayed as a URL:

```
<Example URL="//myHost/a/c äöü%.pdf"/>
```

Example A.42: URL: UTF-8

New in JDF 1.4

The UNC path encoded as an IRL with internationalized characters in UTF-8:

```
<Example URL="file:///myHost/a/c%20äöü%25.pdf"/>
```

Example A.43: URL: Windows Locale 1252

New in JDF 1.4

The same UNC path encoded as an IRL with internationalized characters in UTF-8 viewed in a windows locale 1252:

```
<Example URL="file:///myHost/a/c%20Ã¤Å¶Ã%25.pdf"/>
```

Example A.44: URL: Escaped Characters

New in JDF 1.4

The same UNC path encoded as an IRL with internationalized characters escaped:

```
<Example URL="file:///myHost/a/c%20%c3%a4%c3%b6%c3%bc%25.pdf"/>
```

A.2.45 XPath

New in JDF 1.2

Values of type XPath represent an XPath expression as described in ▶ [XPath]

Encoding

It is represented as being identical to the XML schema type: *token*

Example A.45: XPath

```
<Example xpath="JDF/AuditPool/Created/@TimeStamp"/>
```

A.2.46 XYPair

Values of type XYPair are used to describe sizes, e.g. *@Dimensions* and *@StartPosition*. They can also be used to describe positions on a page. All numbers that describe lengths are defined in points.

Encoding

XYPair attributes are primitive data types and are encoded as a string of two *numbers*, separated by whitespace: “x y”

Example A.46: XYPair

```
<CutBlock BlockSize="612 792"/>
```

Implementation Remark

Since all numbers are real numbers, comparison of XYPair values SHOULD take into account certain rounding errors. For example, different XYPair values MAY be considered equal when all numbers are the same within a range of 1 point.

A.2.47 XYPairRange

XML attributes of type XYPairRange are used to describe a range of XYPair values. The range “x1 y1 ~ x2 y2” describes the area $x1 \leq x \leq x2$ and $y1 \leq y \leq y2$. Thus the XYPair “2 3” is within “1 2 ~ 3 4”.

Note: This implies that both values of the second entry SHALL be \geq the corresponding values of the first entry. The following example is therefore invalid: “1 2 ~ 0 4”.

Encoding

An XYPairRange is represented by two XYPair values, separated by a “~” (tilde) character and optional additional whitespace.

Note: It is now RECOMMENDED that the ‘~’ be surrounded by whitespace to aid validation and parsing.

Example A.47: XYPairRange

```
<Example XYrange="1 2 ~ 3 4"/>
<Example XYrange="-INF 2 ~ 3 INF"/>
```

A.2.48 XYPairRangeList

XML attributes of type XYPairRangeList are used to describe a list of XYPairRange and/or XYPair values.

Encoding

A XYPairRangeList is a sequence of XYPairRange and XYPair values separated by whitespace.

Example A.48: XYPairRangeList

The brackets below the example illustrate the grouping of XYPair values and XYPairRange values.

```
<Example XYlist="100 200 ~ 110 220 150 300 150 350 200 300 ~ INF INF"/>
<!-- Grouping [ [ [ [ [ ] ] ] ] -->
```

A.3 Enumerations

This section contains tables each with a closed set of values for an enumeration or enumerations type. If there are any implications to the order of the values this will be detailed in the description, otherwise no order is implied.

A.3.1 Action

Action specifies what action if any to take as a result of a particular event.

Table A.1: Action Enumeration Values

VALUE	DESCRIPTION
Abort	Abort the ongoing activity and do not proceed with any other further activity.
Continue	Continue with the present activity. Details SHOULD be logged.
Repair	Repair the condition before proceeding with the activity. Details SHOULD be logged. Note: The actions required to perform the repair are system specified.

A.3.2 Activation

Activation SHALL specify the activation of a JDF node or [QueueEntry](#).

Note: The values in the following table are ordered from least active to most active.

Table A.2: Activation Enumeration Values (Sheet 1 of 2)

VALUE	DESCRIPTION
Inactive	The node and all its descendents SHALL NOT be executed or tested. This value is set if certain parts of a JDF job SHALL NOT be executed or tested.
Informative	The JDF is for information only. If a job is "Informative", it SHALL NOT be processed. jobs with <code>@Activation = "Informative"</code> will generally be sent to an operator console for preview but are still completely under the control of an external controller. When a JDF ticket is supplied to a customer as proof of execution, its <code>@Activation</code> SHOULD also be "Informative". When a new job ticket with an identical <code>@ID</code> attribute and a higher <code>@Activation</code> is submitted to a device, that JDF job ticket SHALL replace the JDF job ticket that was submitted to the device with an <code>@Activation</code> of "Informative".
Held	Execution has been held and SHALL NOT be processed until its <code>@Activation</code> is changed to "Active".
TestRun	The node requests a test run check by a controller or a device. This does not imply that the node is to be automatically executed when the check is completed. Descendents of a node that is being test run are not to be considered "Active".
TestRunAndGo	Similar to "TestRun", but requests a subsequent automatic start if the test run has been completed successfully.

Table A.2: Activation Enumeration Values (Sheet 2 of 2)

VALUE	DESCRIPTION
Active	The default value if not specified in a parent node – The node SHALL be executed according to the steps specified in ▶ Section 4.2.1 Determining Executable nodes.

A.3.3 Anchor

New in JDF 1.4

Anchor specifies the nine anchor points of a rectangle.

Table A.3: Anchor Enumeration Values (Sheet 1 of 2)

VALUE	DESCRIPTION
BottomCenter	
BottomLeft	
BottomRight	
Center	
CenterLeft	
CenterRight	
TopCenter	

Table A.3: Anchor Enumeration Values (Sheet 2 of 2)

VALUE	DESCRIPTION
TopLeft	
TopRight	

A.3.4 ArtHandling

ArtHandling specifies what is to happen to artwork after it has been used.

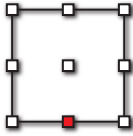
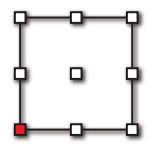
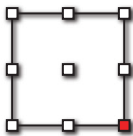
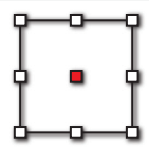
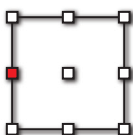
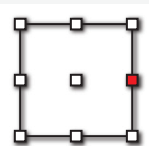
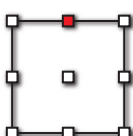
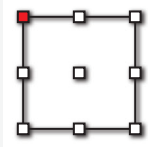
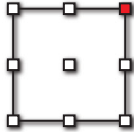
Table A.4: ArtHandling Enumeration Values

VALUE	DESCRIPTION
Destroy	The printer destroys the artwork.
Pickup	The customer picks up the artwork.
PrinterOwns	The artwork belongs to the printer.
Return	The artwork is returned to the customer independently directly after usage.
ReturnWithProduct	The artwork is returned to the customer together with the final product.
ReturnWithProof	The artwork is returned to the customer together with the proof if there is any.
Store	The printer has to store the artwork for future purposes.

A.3.5 ArtTransfer

ArtTransfer specifies the direction of artwork transfer between buyer and printer.

Table A.5: ArtTransfer Enumeration Values

VALUE	DESCRIPTION
BuyerToPrinterDeliver	The buyer delivers the artwork to the printer. The printer MAY specify in the quote a special Contact [@ContactTypes="Delivery"]) to specify where the buyer SHALL send the artwork.
BuyerToPrinterPickup	The printer picks up the artwork. The Contact [@ContactTypes="Pickup"]) specifies where the printer has to pick up the artwork.

A.3.6 Automation

Automation specifies how complete an item is.

Table A.6: Automation Enumeration Values

VALUE	DESCRIPTION
Dynamic	The item is incomplete and should be completed automatically.
Static	The item is complete.

A.3.7 Axis

Axis specifies the notional line around which an operation, such as mirroring, SHALL be performed.

Table A.7: Axis Enumeration Values

VALUE	DESCRIPTION
Both	The operation is performed around both axes.
FeedDirection	The operation is performed around the feed direction axis.
MediaWidth	The operation is performed around the media width axis.
None	No operation is to be performed.

A.3.8 BinderMaterial

BinderMaterial specifies the material that SHALL be used for loose binding.

Table A.8: BinderMaterial Enumeration Values

VALUES	DESCRIPTION
ColorCoatedSteel	Coated steel.
Plastic	Any kind of plastic.
Steel	Plain steel.

A.3.9 BindingType

BindingType specifies the required style of binding to be used.

Table A.9: BindingType Enumeration Values (Sheet 1 of 2)

VALUE	DESCRIPTION
Adhesive Deprecated in JDF 1.1	This type of binding is handled by the AdhesiveBinding process. It includes perfect binding. Deprecated in JDF 1.1 and replaced with " SoftCover " or " HardCover ".
AdhesiveNote New in JDF 1.6	Binding with removable adhesive on the back side of a product. Typically used for small brightly colored paper designed to be stuck prominently to an object or surface and easily removed when necessary.
ChannelBinding	Metal clamps are used to bind sheets. This type of binding is handled by the ChannelBinding process.
CoilBinding	Metal wire, plastic coated wire or pure plastic wire is used to fasten pre-punched sheets of paper, cardboard or other materials. This type of binding is handled by the CoilBinding process.
CombBinding New in JDF 1.6	Plastic insert wraps through pre-punched holes in the substrate. This type of binding is handled by one of the PlasticCombBinding or WireCombBinding processes..
CornerStitch New in JDF 1.2	Stitch in the corner that is at the clockwise end of the binding edge. This type of binding is handled by the Stitching process.
EdgeGluing	Gluing gathered sheets at one edge of the pile. This type of binding is handled by the Gluing process. Products of this type are also referred to as padded.
HardCover	This type of binding defines a hardcover bound book. This type of binding is handled by the CaseMaking process.
LooseBinding New in JDF 1.6	Generic loose binding – one of " ChannelBinding ", " CoilBinding ", " CombBinding ", " Ring " or " StripBind ". These types of binding are handled by the process given by the matching entry in this table.
None	This type of binding defines a stack of pages with no additional binding.
PlasticComb	Plastic insert wraps through pre-punched holes in the substrate. This type of binding is handled by the PlasticCombBinding process.

Table A.9: BindingType Enumeration Values (Sheet 2 of 2)

VALUE	DESCRIPTION
Ring	Pre-punched sheets are placed in a ring binder. This type of binding is handled by the RingBinding process.
SaddleStitch	Sheets are bound together using stitches along the middle fold which is on a saddle. This type of binding is handled by the Stitching process.
Sewn Deprecated in JDF 1.4	This type of binding is handled by the ThreadSewing process.
SideSewn Deprecated in JDF 1.4	This type of binding is handled by the ThreadSewing process.
SideStitch	Sheets are bound together using stitches along the reference edge. This type of binding is handled by the Stitching process.
SoftCover	This type of binding defines a softcover bound book. It includes perfect binding and is handled by the CoverApplication process.
StripBind	Hard plastic strips are held together by plastic pins, which in turn are bound to the strips with heat. This type of binding is handled by the StripBinding process.
Tape	This type of binding is an inexpensive version of "SoftCover". It is handled by the CoverApplication process.
ThreadSealing Deprecated in JDF 1.4	This type of binding is handled by the ThreadSealing process.
ThreadSewing Deprecated in JDF 1.4	This type of binding is handled by the ThreadSealing process.
WireComb	Wire is used to fasten pre-punched sheets of paper, cardboard or other materials. This type of binding is handled by the WireCombBinding process.

A.3.10 BoxType

BoxType specifies the intended use of a rectangular region.

Table A.10: Box Enumeration Values (Sheet 1 of 2)

BOX TYPE	DESCRIPTION
ArtBox	Defines the extent of the page's meaningful content (including potential white space) as intended by the page's creator.
BleedBox	Defines the region to which the contents of the page SHALL be clipped when output in a production environment. This might include any extra "bleed area" needed to accommodate the physical limitations of cutting, folding and trimming equipment. The actual printed page might include printing marks that fall outside the bleed box.
CropBox	Defines the region to which the contents of the page are to be clipped (cropped) when displayed or printed. Unlike the other boxes, the crop box has no defined meaning in terms of physical page geometry or intended use — it merely imposes clipping on the page contents. However, in the absence of additional information, the crop box will determine how the page's contents are to be positioned on the output medium.
MarginsBox	Defines the trim box minus the margins.
MediaBox	Defines the boundaries of the physical medium on which the page SHALL be printed. It might include any extended area surrounding the finished page for bleed, printing marks or other such purposes. It might also include areas close to the edges of the medium that cannot be marked because of physical limitations of the output device. Content falling outside this boundary can safely be discarded without affecting the meaning of the file.
SlugBox	Defines an area where document related information and objects that will not be on the final document could be printed.

Table A.10: Box Enumeration Values (Sheet 2 of 2)

BOX TYPE	DESCRIPTION
TrimBox	Defines the intended dimensions of the finished page after trimming. It can be smaller than the media box, to allow for production-related content such as printing instructions, cut marks or color bars. In document types other than PDF, this box represents the page size.

A.3.11 BundleType

BundleType specifies the type of items that are bundled.

Table A.11: BundleType Enumeration Values

VALUES	DESCRIPTION
BoundSet	Stack of components that are bound together.
Box	Convenience packaging that is not envisioned to be protection for shipping.
Carton	Protection packaging typically used for shipping.
CollectedStack	Components collected on a saddle, e.g. as a result of the Collecting process.
CompensatedStack	Loose stack of compensated components.
Pallet	
Product	An individual product.
Roll	Rolled components on a print roll.
Sheet	Multiple individual items printed on one sheet.
Stack	Loose stack of equally stacked components.
StrappedCompensatedStack	Strapped stack of compensated components.
StrappedStack	Strapped stack of equally stacked components.
WrappedBundle	

A.3.12 ChannelMode

ChannelMode specifies the reliability mode of a message channel.

Table A.12: ChannelMode Enumeration Values

VALUES	DESCRIPTION
FireAndForget	The receiver of the signal MAY respond using a JMF response message.
Reliable	Indicates that the signal is the result of a subscription where reliable signaling was specified. The receiver of the signal SHALL respond using a JMF response message.

A.3.13 Coating

Coating specifies the coating of a substrate.

Table A.13: Coating Enumeration Values (Sheet 1 of 2)

VALUE	DESCRIPTION
Coated	A coating of a system specified type.
HighGloss	A high gloss coating.
InkJet New in JDF 1.2 Deprecated in JDF 1.4	A coating intended for use with inkjet technology.

Table A.13: Coating Enumeration Values (Sheet 2 of 2)

VALUE	DESCRIPTION
Glossy	A glossy coating.
Matte	A matte coating.
None	No coating.
Satin	A coating between "Gloss" and "Matte".
Semigloss	A semi gloss coating.

A.3.14 Compensation

Compensation specifies how a process SHALL apply transfer curve compensation.

Table A.14: Compensation Enumeration Values

VALUES	DESCRIPTION
Film	Compensated until film exposure.
None	No compensation.
Plate	Compensated until plate exposure.
Press	Compensated until press.
Unknown Deprecated in JDF 1.2	

A.3.15 DataType

DataType is used to specify the data type of a value where it cannot be inferred from the context and thus needs to be explicitly stated. It is therefore expected that DataType will be suitably paired with an item containing the value.

Table A.15: DataType Enumeration Values

VALUES	DESCRIPTION
boolean	Binary value logic, either "true" or "false".
dateTime	Represents a specific instant of time. It SHALL be a UTC time or a local time that includes the time zone.
double	Corresponds to ▶ [IEEE754] double-precision, 64-bit floating point type, including special tokens INF and -INF. This corresponds to the standard XML double with NaN removed. For details, see ▶ [XMLSchema]. Note: Prior to JDF 1.2 the data type number was used. The double and number data types are syntactically equivalent.
duration	Represents a duration of time.
integer	Represents numerical integer values, including the special tokens INF and -INF. This corresponds to the standard XML integer with INF and -INF added. Values greater than $+/-2^{*}31$ are not expected to occur for this data type. For details, see ▶ [XMLSchema].
NamedFeature	This represents a ▶ NamedFeature as defined in ▶ Table 1.4 Glossary New in JDF 1.5 . Note: NamedFeature describes a value that is identified by a specific name, thus in this case it is expected to have both an item containing the value and an item containing the name. For example: <pre><GeneralID DataType="NamedFeature" IDUsage="pool" IDValue="bar snax" /></pre>
NMTOKEN	A continuous sequence of special characters as defined by ▶ [XML].
string	Character strings without tabs or line feeds. Corresponds to the standard XML normalizedString data type. For details, see ▶ [XMLSchema].

A.3.16 DefaultPriority

DefaultPriority specifies the source of preset values to be applied to a resource.

Table A.16: DefaultPriority Enumeration Values

VALUES	DESCRIPTION
Application	Application default settings are used.
DefaultJDF	Settings from another JDF (referenced elsewhere) are used.

A.3.17 DeliveryCharge

DeliveryPayer specifies who is responsible for paying for the delivery.

Table A.17: DeliveryPayer Enumeration Values

VALUES	DESCRIPTION
Buyer	The customer.
Other New in JDF 1.2	The person specified in Contact [@ContactTypes="DeliveryCharge"].
Printer	The person who creates the resource that is being delivered. This includes all suppliers, e.g. binder, prepress suppliers, etc.

A.3.18 Drying

Drying specifies the method employed to dry an item.

Table A.18: Drying Enumeration Values

VALUE	DESCRIPTION
Heatset	Heatset dryer.
IR	Infrared dryer.
Off	No dryer is used.
On	The device's default drying unit is used.
UV	Ultraviolet dryer.

A.3.19 Edge

Edge specifies the edge of an object.

Table A.19: Edge Enumeration Values

VALUES	DESCRIPTION
Bottom	Bottom edge of a sheet or product.
Left	Left edge of a sheet or product.
Right	Right edge of a sheet or product.
Top	Top edge of a sheet or product.

A.3.20 ElementType

ElementType specifies the type of content expected in an element.

Table A.20: ElementType Attribute Values (Sheet 1 of 2)

VALUE	DESCRIPTION
Auxiliary	Any type of file that is needed to complete a layout but not explicitly displayed (e.g., ICC profiles or fonts).

Table A.20: ElementType Attribute Values (Sheet 2 of 2)

VALUE	DESCRIPTION
Barcode New in JDF 1.3	A barcode.
Composed	Combination of elements that define an element that is not bound to a document page.
Document	An ordered set of one or more pages.
Graphic	Line art.
IdentificationField New in JDF 1.3	A general identification field excluding bar codes.
Image	Bitmap image.
MultiDocument	An ordered set of one or more documents including document breaks (e.g., PPML, PPML/VDX, MIME Multipart/Related).
MultiSet	An ordered set of one or more document sets, including document set breaks, document breaks and sub document breaks (e.g., PPML, PPML/VDX, ISO 16612-2 PDF/VT). Modification note: Starting with JDF 1.4, 3 kinds of breaks are added.
Page	Representation of one document page.
Reservation	Empty element. Content for this area of the page might be provided by a subsequent process.
Surface	Representation of an imposed surface.
Text	Formatted or unformatted text.
Tile	Representation of the contents of one tile.
Unknown Deprecated in JDF 1.2	

A.3.21 EmbossDirection

EmbossDirection specifies the type and direction of embossing.

Table A.21: EmbossDirection Enumeration Values

VALUES	DESCRIPTION
Both	Both debossing and embossing using one stamp.
Depressed	Debossing only.
Flat New in JDF 1.3	The embossing foil is applied flat. Used for foil stamping.
Raised	Embossing only.

A.3.22 EmbossLevel

EmbossLevel specifies the profile of the embossing.

Table A.22: EmbossLevel Enumeration Values

VALUES	DESCRIPTION
MultiLevel	
Sculpted	
SingleLevel	

A.3.23 EmbossType

EmbossType specifies the type of embossing required.

Table A.23: EmbossType Enumeration Values

VALUES	DESCRIPTION
BlindEmbossing	Embossed forms are not inked or foiled. The color of the image is the same as the substrate.
Braille New in JDF 1.3 (Errata)	Six dot braille embossing.
EmbossedFinish	The overall design or pattern is impressed in laminated paper when passed between metal rollers engraved with the desired pattern. It is produced on a special embossing device to create finishes such as linen.
FoilEmbossing	Combines embossing and foil stamping in a single operation.
FoilStamping	Uses a heated die to place a metallic or pigmented image from coated foil onto the substrate.
RegisteredEmbossing	Creates an embossed image that is registered exactly with a printed image.

A.3.24 FeedQuality

FeedQuality specifies the action of a feeder in response to a feeder failure condition.

Table A.24: FeedQuality Enumeration Values

VALUES	DESCRIPTION
Check	Check the quality and register.
NotActive	Quality control is not active.
StopNoWaste	Check the quality and register. The consuming device SHALL stop after the predefined number of consecutive errors. The error SHALL be corrected, e.g. manually.
StopWaste	Check the quality and register. The object failing the test SHALL be waste. The consuming device SHALL stop after the predefined number of consecutive errors. The error SHALL be corrected, e.g. manually.
Waste	The object failing the test SHALL be waste.

A.3.25 FitPolicy

FitPolicy specifies how an object should be manipulated to enable it to fit into a given area.

Note: The ‘given direction’ in the following text is derived from the attribute’s context, i.e. for [@HorizontalFitPolicy](#) this would be horizontal.

Table A.25: FitPolicy Enumeration Values

VALUES	DESCRIPTION
NoRepeat	The object is neither resized nor repeated. If it is bigger than the given area then it SHALL be clipped.
RepeatToFill	The object SHALL be placed in the requested position. It SHALL then be repeated in the given direction, allowing clipping to occur, until all the allocated space is filled.
RepeatUnclipped	The object SHALL be placed in the requested position. It SHALL then be repeated in the given direction, without clipping, to fill as much of the allocated space as possible.
StretchToFit	The object SHALL be stretched along the given direction to entirely fill the allocated space. Note: If used in isolation this can result in distortion of the object’s aspect ratio.
UndistortedScaleToFit	The object SHALL be resized to fit in the given direction. Note: For the orthogonal direction this may result in either the object being clipped or the object not filling the allocated space.

A.3.26 GangPolicy

GangPolicy specifies how multiple jobs SHALL be ganged.

Table A.26: GangPolicy Enumeration Values

VALUES	DESCRIPTION
Gang	The job SHALL be ganged and MAY be submitted to the device.
GangAndForce	The job SHALL be ganged and SHALL be submitted to the device.
NoGang	The job SHALL NOT be ganged.

A.3.27 Glue

Glue specifies the type of glue to be used.

Table A.27: Glue Enumeration Values

VALUES	DESCRIPTION
ColdGlue	
Hotmelt	
PUR	Polyurethane rubber.

A.3.28 IncludeResources

IncludeResources specifies how fonts SHALL be embedded.

Table A.28: IncludeResources Enumeration Values

VALUES	DESCRIPTION
IncludeNever	Never embed fonts.
IncludeOncePerDoc	Embed once per document.
IncludeOncePerPage	Embed once per page.

A.3.29 ISOPaperSubstrate

ISOPaperSubstrate specifies a print substrate according to ▶ [ISO12647-2:2013].

Note: See ▶ Section E.3 Paper Grade for a mapping to the paper grade values defined in ▶ [ISO12647-2:2004].

Table A.29: ISOPaperSubstrate Enumeration Values

VALUE	DESCRIPTION
PS1	Premium coated.
PS2	Improved coated.
PS3	Standard coated glossy.
PS4	Standard Coated Matte.
PS5	Wood-free Uncoated.
PS6	Super Calendered.
PS7	Improved Uncoated.
PS8	Standard Uncoated.

A.3.30 JDFJMFVersion

JDFJMFVersion specifies the schema version of a **JDF** or **JMF** instance.

Table A.30: JDFJMFVersion Enumeration Values

VALUE	DESCRIPTION
1.1	JDF 1.1
1.2	JDF 1.2
1.3	JDF 1.3
1.4	JDF 1.4
1.5	JDF 1.5
1.6	JDF 1.6 - this specification.
2.0	XJDF 2.0, see ▶ [XJDF].

A.3.31 ListType

ListType specifies what type of list or object is contained within a list.

Table A.31: ListType Enumeration Values

VALUE	DESCRIPTION
CompleteList	Describes a list of individual values. Each value SHALL occur exactly once.
CompleteOrderedList	Describes an ordered list of individual values. Each value SHALL occur exactly once and in the specified order.
ContainedList	Describes a list of individual values. This value is only expected to be used in BasicPreflightTest elements.
List	Describes a list of individual values.
OrderedList	Describes an ordered list of individual values.
OrderedRangeList	Describes an ordered RangeList of individual values.
Range New in JDF 1.3	Describes an individual Range of values.
RangeList	Describes a RangeList of values.
SingleValue	Describes an individual value.
Span	Describes a Span element in an Intent Resource .
UniqueList	Describes a list of individual values. Each value SHALL NOT occur more than once.
UniqueOrderedList	Describes an ordered list of individual values. Each value SHALL NOT occur more than once.
UniqueOrderedRangeList	Describes an ordered RangeList of individual values. Each explicit or implied value SHALL NOT occur more than once.
UniqueRangeList	Describes a RangeList of values. Each explicit or implied value SHALL NOT occur more than once.

A.3.32 MappingSelection

MappingSelection specifies how a device should construct a color.

Table A.32: MappingSelection Enumeration Values (Sheet 1 of 2)

VALUE	DESCRIPTION
UseLocalPrinterValues	Use the device’s best local mapping.

Table A.32: MappingSelection Enumeration Values (Sheet 2 of 2)

VALUE	DESCRIPTION
UsePDLValues	Use color values specified in the PDL. See ▶ [ColorPS].
UseProcessColorValues	Use the values defined in the associated process.

A.3.33 MediaDirection

MediaDirection specifies a preferred orientation of a characteristic of **Media** such as grain or flute.

Table A.33: MediaDirection Enumeration Values

VALUE	DESCRIPTION
Any New in JDF 1.5	No restrictions apply to alignment of the media property.
Both Deprecated in JDF 1.6	Both orientations are acceptable. Deprecation note: Use Any instead.
LongEdge Deprecated in JDF 1.5	Along the longer axis. Deprecation note: If the product is landscape use XDirection , else if portrait use YDirection .
SameDirection	The media property SHALL be aligned along the same axis of the coordinate system for all items.
ShortEdge Deprecated in JDF 1.5	Along the shorter axis. Deprecation note: If the product is landscape use YDirection , else if portrait use XDirection .
XDirection	The media property SHALL be aligned along the X-axis of the coordinate system.
YDirection	The media property SHALL be aligned along the Y-axis of the coordinate system.

A.3.34 MediaType

MediaType specifies the general type of media to be used.

Table A.34: MediaType Enumeration Values (Sheet 1 of 2)

VALUE	DESCRIPTIONS
Blanket	A blanket used for varnishing. New in JDF 1.3
CorrugatedBoard	New in JDF 1.3
Disc	CD or DVD disc to be printed on.
EndBoard	End board used in the Bundling process.
EmbossingFoil	
Film	
Foil	
GravureCylinder	Gravure cylinder. New in JDF 1.3
ImagingCylinder	Reusable direct imaging cylinder in a press. New in JDF 1.3
LaminatingFoil	
MountingTape	For flexo platem mounting tape. New in JDF 1.4
Other	Something other than a media defined by this table.
Paper	Unprinted paper. Includes single layer cardboard.

Table A.34: MediaType Enumeration Values (Sheet 2 of 2)

VALUE	DESCRIPTIONS
Plate	
Screen	Used for screen printing. New in JDF 1.4
SelfAdhesive	New in JDF 1.3
ShrinkFoil	
Sleeve	Flexo sleeve. New in JDF 1.4
Textile	New in JDF 1.5
Transparency	
Unknown	Deprecated in JDF 1.2
Vinyl	New in JDF 1.5

A.3.35 NamedColor

Colors of preprocessed products such as Wire-O binders and cover leaflets. The entries in the following table MAY be prefixed by either “Dark” or “Light”. The result MAY additionally be prefixed by “Clear” to indicate translucent material. For example, “ClearDarkBlue” indicates a translucent dark blue, “ClearBlue” a translucent blue and “Blue” indicates an opaque blue.

Table A.35: NamedColor Enumeration Values

COLOR NAME/ ENUMERATION VALUE	DESCRIPTION	COLOR NAME/ ENUMERATION VALUE	DESCRIPTION
Black	—	MultiColor New in JDF 1.1	
Blue	—	Mustard New in JDF 1.1	
Brown	—	NoColor	—
Buff	—	Orange	—
Cyan New in JDF 1.2		Pink	—
Gold	—	Red	—
Goldenrod	—	Silver	—
Gray	—	Turquoise	—
Green	—	Violet	—
Ivory	—	White	—
Magenta New in JDF 1.2		Yellow	—

A.3.36 Opacity

Opacity specifies the opacity of a resource.

Table A.36: Opacity Enumeration Values (Sheet 1 of 2)

VALUE	DESCRIPTION
Opaque	The media or resource is opaque and does not transmit light under normal incident lighting conditions.

Table A.36: Opacity Enumeration Values (Sheet 2 of 2)

VALUE	DESCRIPTION
Translucent New in JDF 1.2	The media or resource is translucent to a system specified degree. For example, translucent material can be used for back lit viewing.
Transparent	The media is transparent to a system specified degree.

A.3.37 Orientation

Orientation specifies the orientation of a **PhysicalResource**. For details see ▶ Table 2.4 Matrices and Orientation values for describing the orientation of a Component.

Table A.37: Orientation Enumeration Values

VALUE	EQUIVALENT TRANSFORMATION MATRIX	DESCRIPTION
Rotate0	1 0 0 1 0 0	No Action
Rotate90	0 1 -1 0 h 0	90° Counterclockwise Rotation
Rotate180	-1 0 0 -1 w h	180° Rotation
Rotate270	0 -1 1 0 0 w	270° Counterclockwise Rotation
Flip0	1 0 0 -1 0 h	Flip around X
Flip90	0 -1 -1 0 h w	90° Counterclockwise Rotation + Flip around X
Flip180	-1 0 0 1 w 0	180° Rotation + Flip around X
Flip270	0 1 1 0 0 0	270° Counterclockwise Rotation + Flip around X

Note: In the transformation matrix above, 'h' and 'w' refer to the height and width of the object being transformed.

A.3.38 Polarity

Polarity specifies whether a given image SHALL be color inverted.

Table A.38: Polarity Enumeration Values

VALUE	DESCRIPTION
Negative	The image is color-inverted.
Positive	The image is not color-inverted.

A.3.39 PositionPolicy

PositionPolicy specifies the level of freedom when applying placement or positioning values.

Table A.39: PositionPolicy Enumeration Values

VALUE	DESCRIPTION
Exact	The values SHALL be followed precisely.
Free	The values are used as guidance and MAY be modified by the designer.

A.3.40 PreflightStatus

PreflightStatus specifies the results of any preflighting applied to artwork prior to being submitted.

Table A.40: :PreflightStatus Enumeration Values (Sheet 1 of 2)

VALUE	DESCRIPTION
NotPerformed	No preflighting was applied.
WithErrors	Preflighting resulted in error messages and possibly warning messages.

Table A.40: :PrelightStatus Enumeration Values (Sheet 2 of 2)

VALUE	DESCRIPTION
WithoutErrors	Preflighting was successful. No errors and no warnings occurred.
WithWarnings	Preflighting resulted in warning messages and no errors.

A.3.41 PreviewUsage

Preview usage specifies the type and useage of a preview.

Table A.41: PreviewUsage Enumeration Values

VALUE	DESCRIPTION
Animation	Animated previews for 3D display. New in JDF 1.4
Identification	The preview is used as a visual aid to help identify one or more products, e.g. on a gang form. New in JDF 1.5
SeparatedThumbNail	Very low resolution separated preview.
Separation	Separated preview with medium resolution. Separation is generally used in the InkZoneCalculation process.
SeparationRaw	Separated preview with medium resolution. This is identical to "Separation" except that no compensation has been applied. "SeparationRaw" is generally used for closed loop color control.
Static3D	Static 3D model. New in JDF 1.4 Modified in JDF 1.5 Modification Note: Starting with JDF 1.5 , "3D" was renamed to "Static3D" because enumerations shall not begin with a number in XML.
ThumbNail	Very low resolution RGB preview.
Viewable	Medium resolution RGB preview.

A.3.42 QueueEntryStatus

QueueEntryStatus specifies the status of an individual entry in a queue.

Table A.42: QueueEntryStatus Enumeration Values

VALUE	DESCRIPTION
Aborted New in JDF 1.2	Indicates that the process executing the node has been aborted, which means that execution will not be resumed again.
Completed New in JDF 1.2	Indicates that the node or queue entry has been executed correctly, and is finished.
Held	The queue entry is held and SHALL NOT execute until resumed. Note: A held entry with @GangPolicy other than "NoGang" does not interact with its respective gang.
PendingReturn New in JDF 1.3	Indicates that the entry has been executed correctly, and is finished, but that the corresponding JDF has not yet been successfully returned to the respective controller.
Removed	The queue entry has been removed. This status can only be sent when a persistent channel watches a queue and the queue entry is removed.
Running	The queue entry is running on the device. Note: An entry is "Running" when JDF/@Status of any node associated with the queue entry is one of "Setup", "InProgress" or "Cleanup".
Suspended New in JDF 1.2	The queue entry was running and has been held. It will not continue to execute until resumed.
Waiting	The queue entry is waiting and will be executed when resources are available.

A.3.43 RenderingIntent

RenderingIntent specifies the rendering intent that SHALL be applied when rendering the selected object. Values are defined in ▶ [ICC.1].

Table A.43: RenderingIntent Enumeration Values

VALUE	DESCRIPTION
AbsoluteColorimetric	
ColorSpaceDependent Modified in JDF 1.3	The rendering intent is dependent on the color space. The dependencies are implementation specific.
Perceptual	
RelativeColorimetric	
Saturation	

A.3.44 ResourceClass

ResourceClass specifies the class and intended usage of a resource.

Table A.44: ResourceClass Enumeration Values

VALUE	DESCRIPTION
Consumable	
Handling	
Implementation	
Intent	
Parameter	
Placeholder Deprecated in JDF 1.5	
Quantity	

A.3.45 ResourceStatus

ResourceStatus specifies the relative readiness of a resource. See also ▶ Section A.3.55 Status for the status of a process.

Note: In the following table the values are ordered from the lowest to the highest. .

Table A.45: ResourceStatus Enumeration Values

VALUE	DESCRIPTION
Incomplete	Indicates that the resource does not exist, and the metadata is not yet valid. Incomplete resources NEED NOT specify all attributes or elements defined in ▶ Chapter 8 Resources.
Rejected	Indicates that the resource has been rejected by an Approval process. The metadata is valid. New in JDF 1.2
Unavailable	Indicates that the resource is not ready to be used or that the resource in the real world represented by the PhysicalResource in JDF is not available for processing. The metadata is valid.
InUse	Indicates that the resource exists, but is in use by another process. Also used for active pipes. See ▶ Section 3.8.7 Pipe Resources and ▶ Section 4.3.3 Overlapping processing Using Pipes.
Draft	Indicates that the resource exists in a state that is sufficient for setting up the next process but not for production.

Table A.45: ResourceStatus Enumeration Values

VALUE	DESCRIPTION
Complete	Indicates that the resource is completely specified and the parameters are valid for usage. A <i>PhysicalResource</i> with @Status="Complete" is not yet available for production, although it is sufficiently specified for a process that references it through a <i>ResourceRef</i> from a <i>Parameter Resource</i> to commence execution.
Available	Indicates that the whole resource is available for usage.

A.3.46 ResourceUsage

Resource usage specifies whether a resource will be created or consumed by the process to which it is linked.

Table A.46: ResourceUsage Enumeration Values

VALUE	DESCRIPTION
Input	The resource is an input.
Output	The resource is an output.

A.3.47 Scope

Scope specifies the availability of resources and amounts in a device.

Table A.47: Scope Enumeration Values

VALUES	DESCRIPTION
Allowed	The resources are potentially available but currently not available without operator intervention.
Estimate New in JDF 1.6	The amount of resources is an estimate that a device has calculated within the scope of a job.
Job New in JDF 1.6	The amount of resources is an actual measurement of data that is currently available within the scope of a job.
Present	The resources are currently available without operator intervention.

A.3.48 Severity

Severity specifies the severity of an error.

Note: This table is not ordered alphabetically - it is ordered by increasing level of severity.

Table A.48: Severity Enumeration Values

VALUES	DESCRIPTION
Event	Normal operating event.
Information	Informational event worthy of being logged.
Warning	A minor error. The executing device is able to repair the condition and continue.
Error	A significant error. Operator intervention is required to allow the device to continue.
Fatal	A fatal error. The device has aborted the operation and cannot continue.

A.3.49 SheetLay

SheetLay specifies the reference edge where media or components are placed in a **Device**. SheetLay SHALL be specified in the **Device** coordinate system and therefore applies to the media or component after any rotation specified in **ResourceLink/@Orientation** or **ResourceLink/@Transformation** has been applied.

Table A.49: SheetLay Enumeration Values

VALUE	DESCRIPTION
Center	The media is placed in the center. This is most commonly used in web devices.
Left	The media is placed so that it is guided on the left.
Right	The media is placed so that it is guided on the right.

A.3.50 Side

Side specifies which side is to be used for an action.

Table A.50: Side Enumeration Values

VALUES	DESCRIPTION
Back	The back surface.
Front	The front surface.

A.3.51 Sides

Sides specifies the sides of the media or product that SHALL be imaged.

Table A.51: Sides Enumeration Values

VALUE	DESCRIPTION
OneSided	Page contents SHALL be imposed on the front side.
OneSidedBack	Page contents SHALL be imposed on the back side.
TwoSidedHeadToFoot	Page contents SHALL be imposed on the front and back sides of media sheets so that the head (top) of the front backs up to the foot (bottom) of the back.
TwoSidedHeadToHead	Page contents SHALL be imposed on the front and back sides so that the head (top) of the page contents back up to each other.

A.3.52 SourceColorSpace

SourceColorSpace specifies the color space that is to be operated on.

Table A.52: SourceColorSpace Enumeration Values (Sheet 1 of 2)

VALUE	DESCRIPTION
All New in JDF 1.4	Operates on all source color spaces. This is useful when specifying a convert operation using all PDL source-supplied characterizations with a JDF supplied final target device profile.
CalGray New in JDF 1.3	Defines a calibrated device independent representation of gray.
Calibrated New in JDF 1.2	Operates on "CalGray" and "CalRGB" color spaces.
CalRGB New in JDF 1.3	Defines a calibrated device independent representation of RGB. Note: JDF 1.1 defined that "CalRGB" be treated as "RGB", "CalGray" as "Gray" and "ICCBased" color spaces as one of "Gray", "RGB" or "CMYK" depending on the number of channels.
CIEBased New in JDF 1.2	Operates on CIE based color spaces; CIEBasedA , CIEBasedABC , CIEBasedDEF and CIE-BasedDEFG .

Table A.52: SourceColorSpace Enumeration Values (Sheet 2 of 2)

VALUE	DESCRIPTION
CMYK	Operates on all CMYK color spaces. This includes both characterized and uncharacterized CMYK color spaces.
DeviceCMYK New in JDF 1.4	Operates on uncharacterized CMYK color spaces.
DeviceGray New in JDF 1.4	Operates on uncharacterized gray color spaces.
DeviceN New in JDF 1.2	Identifies the source color encoding as a "DeviceN" color space. The specific "DeviceN" color space to operate on is defined in the DeviceNSpace resource. If "DeviceN" is specified, then the DeviceNSpace and ColorantControl/ColorPool relements SHALL also be present.
DeviceRGB New in JDF 1.4	Operates on uncharacterized RGB color spaces.
DevIndep	Operates on device independent color spaces (equivalent to "Calibrated", "CIEBased", "ICCBased", "Lab" or "YUV"). Note: "DevIndep" has been retained for backwards compatibility with JDF 1.1 and because there will probably be cases where the same processing is to be applied to all device independent spaces. An equivalent "DevDep" has not been added because it's less likely that all device dependent spaces are to be treated in the same way.
Gray	Operates on all gray color spaces. This includes both characterized and uncharacterized gray color spaces.
ICCBased New in JDF 1.2	Operates on color spaces defined using ICC profiles. The "ICCBased" value includes EPS, TIFF or PICT files with embedded ICC profiles. See ▶ [ICC.1]. It also includes PDF device color spaces that are characterized in ▶ table footnote #b of ▶ Table A.53 Mapping of SourceColorSpace enumerations to color spaces in the most common input file formats.
ICCCMYK New in JDF 1.3	Operates on ICCBased color spaces with ICC CMYK profiles or DeviceCMYK having an ICC-based characterization. See ▶ table footnote #b of ▶ Table A.53 Mapping of SourceColorSpace enumerations to color spaces in the most common input file formats.
ICCGray New in JDF 1.3	Operates on ICCBased color spaces with ICC gray profiles or DeviceGray having an ICC-based characterization. See ▶ table footnote #b of ▶ Table A.53 Mapping of SourceColorSpace enumerations to color spaces in the most common input file formats.
ICCLAB New in JDF 1.3	Operates on an ICCBased device independent representation of Lab.
ICCRGB New in JDF 1.3	Operates on ICCBased color spaces with ICC RGB profiles or DeviceRGB having an ICC-based characterization. See ▶ table footnote #b of ▶ Table A.53 Mapping of SourceColorSpace enumerations to color spaces in the most common input file formats.
Lab New in JDF 1.2	Operates on Lab color spaces.
RGB Modified in JDF 1.2	Operates on all RGB color spaces. This includes both characterized and uncharacterized RGB color spaces.
Separation New in JDF 1.2	Operates on separation color spaces (spot colors). The specific separation(s) to operate on are defined in the SeparationSpec resource(s). If SeparationSpec is not defined, the operation will operate on all the separation color spaces in the input RunList .
YUV New in JDF 1.2	Operates on Yuv color spaces (also known as YCbCr). See ▶ [BT.601-7].

A.3.52.1 Source color space mapping

This table summarizes how the color spaces in ▶ Table A.3.52 SourceColorSpace above SHALL be mapped to/from different file formats.

Table A.53: Mapping of SourceColorSpace enumerations to color spaces in the most common input file formats (Sheet 1 of 2)

SOURCECS	FILE FORMAT	COLOR SPACE
Calibrated	PDF ^a	CalGray, CalRGB
	PostScript ^a	n/a
	TIFF	n/a
CIEBased	PDF ^a	n/a
	PostScript ^a	CIEBasedABC, CIEBasedA, CIEBasedDEF and CIEBasedDEFG
	TIFF	n/a
CMYK	PDF ^a	DeviceCMYK ^b PDF ICCBased color spaces with ICC CMYK profiles. CIEBasedDEFG spaces that resolve to a characterized CMYK space.
	PostScript ^a	DeviceCMYK
	TIFF	PhotometricInterp = 5 Samples per pixel = 4
DeviceCMYK	PDF ^a	DeviceCMYK ^b
	PostScript ^a	DeviceCMYK
	TIFF	PhotometricInterp = 5 Samples per pixel = 4
DeviceGray	PDF ^a	DeviceGray ^b
	PostScript ^a	DeviceGray
	TIFF	PhotometricInterp = 0 or 1
DeviceN	PDF ^a	DeviceN
	PostScript ^a	DeviceN
	TIFF	PhotometricInterp = 5, Samples per pixel = N
DeviceRGB	PDF ^a	DeviceRGB ^b
	PostScript	DeviceRGB
	TIFF	PhotometricInterp = 2
Gray	PDF ^a	DeviceGray ^b PDF ICCBased color spaces with ICC gray profiles. CIEBasedA spaces that resolve to a characterized gray space.
	PostScript ^a	DeviceGray
	TIFF	PhotometricInterp = 0 or 1

Table A.53: Mapping of SourceColorSpace enumerations to color spaces in the most common input file formats (Sheet 2 of 2)

SOURCECS	FILE FORMAT	COLOR SPACE
ICCBased ICCCMYK ICCGray ICCLAB ICCRGB	PDF ^a	ICCBased DeviceGray ^b , DeviceCMYK ^b , DeviceRGB ^b
	PostScript ^a	n/a
	PostScript/EPS	The EPS file has an embedded ICC profile.
	TIFF	The TIFF file has an embedded ICC profile.
Lab	PDF ^a	Lab
	PostScript ^a	n/a
	TIFF	PhotometricInterp = 8 (CIELAB 1976 “normal” encoding) or PhotometricInterp = 9 (CIELAB 1976 using ICC profile v2 encoding).
RGB	PDF ^a	DeviceRGB ^b PDF ICCBased color spaces with ICC RGB profiles. CIEBasedDEF spaces that resolve to a characterized RGB space.
	PostScript	DeviceRGB
	TIFF	PhotometricInterp = 2
Separation	PDF ^a	Separation
	PostScript ^a	Separation
	TIFF	PhotometricInterp = 5 (Applies only to one of the planes in the separated image.)
YUV	PDF ^a	n/a
	PostScript ^a	n/a
	TIFF	PhotometricInterp = 6

- a. Where a **Pattern** or **Indexed** color space has been used in the PDL, the base color space is used to determine whether to apply this operation.
- b. In PDF, DeviceCMYK, DeviceRGB and DeviceGray source color spaces can be characterized through providing a DefaultCMYK, DefaultRGB or DefaultGray resource specifying a profile to be associated with source objects in that color space. In such cases, the resulting color space is considered characterized by **JDF** operations.

A.3.53 SourceObjects

SourceObjects specifies the class of a graphical object. Multiple tokens specify that the action that is filtered by **SourceObjects** applies to all of the listed classes.





Table A.54: SourceObjects Enumeration Values

VALUES	DESCRIPTION
All Deprecated in JDF1.6	All types are allowed.
ImagePhotographic	Contone images.
ImageScreenShot	Images largely comprised of rasterized vector art.
LineArt	Vector objects other than text.
SmoothShades	Gradients and blends.
Text	Text objects.

A.3.54 StapleShape

StapleShape specifies the required shape of the finished staple used for **Stitching**.

Table A.55: StapleShape Enumeration Values

VALUES	DESCRIPTION
Butted	
ClinchOut	
Crown	
Eyelet	
Overlap	

A.3.55 Status

Status specifies the state of a process or part of a node that is required to execute a given task. See also ▶ Section A.3.45 ResourceStatus for the status of a resource.

Table A.56: Status Enumeration Values (Sheet 1 of 2)

VALUE	DESCRIPTIONS
Aborted New in JDF 1.2	Indicates that the process executing the JDF has been aborted, which means that execution will not be resumed again.
Cleanup	The process represented by this node is currently being cleaned up.
Completed New in JDF 1.2	Indicates that the node or queue entry has been executed correctly, and is finished.
FailedTestRun	An error occurred during the test run. Error information is logged in the Notification element, which is an optional subelement of AuditPool .
InProgress	The node is currently executing.
Part New in JDF 1.3	Indicates that the node is processing partitioned resources and that the status varies depending upon the partition keys. Details are provided in the NodeInfo resource of the node.
Pool Deprecated in JDF 1.3	Indicates that the node is processing partitioned resources and that the status varies depending upon the partition keys. Details are provided in the StatusPool element of the node.
Ready	As indicated by the successful completion of a test run; all ResourceLink elements are correct; any required resources are available and the parameters of resources are value. The node is ready to start.
Setup	The process represented by this node is currently being set up.

Table A.56: Status Enumeration Values (Sheet 2 of 2)

VALUE	DESCRIPTIONS
Spawned	The node is spawned in the form of a separate spawned JDF . This status can only be assigned to the original instance of the spawned JDF . See ▶ Section 4.4 Spawning and Merging.
Stopped	Execution has been stopped. If a job is "Stopped", running can be resumed later. This status can indicate a break, a pause, maintenance or a breakdown — in short, any pause that does not lead to the job to be removed from the device.
Suspended New in JDF 1.3 Modified in JDF 1.4	Execution has been stopped. If a job is "Suspended", running will be resumed later. Unlike "Stopped" this status indicates that the job is no longer blocking resources on the device, and other jobs may be run on the device. For instance, a job that has been ripped on a DFE and is waiting for the marker is "Suspended". When resumed, the job MAY go into @Status="Setup" before changing to "InProgress" again. The value "Suspended" is also used to describe iterations. In an iterative environment, "Suspended" specifies that at least one iteration cycle has completed but additional iteration cycles MAY still occur. In this case, @StatusDetails SHOULD be set to "IterationPaused".
TestRunInProgress	The node is currently executing a test run.
Waiting	The node can be executed.

A.3.56 StripMaterial

StripMaterial specifies the material to be used for a resource or process.

Table A.57: StripMaterial Enumeration Values

VALUES	DESCRIPTION
Calico	
Cardboard	
CrepePaper	
Gauze	
Paper	
PaperlinedMules	
Tape	

A.3.57 SurplusHandling

SurplusHandling specifies what happens to unused or redundant items.

Table A.58: SurplusHandling Enumeration Values

VALUES	DESCRIPTION
Destroy	The printer destroys the surplus material.
Pickup	The customer picks up the surplus material.
PrinterOwns	The surplus material belongs to the printer.
Return	The surplus material is delivered back independently directly after usage.
ReturnWithProof	The surplus material is delivered back to the customer together with the final product.
Store	The printer stores the surplus material for future purposes.

A.3.58 TightBacking

TightBacking specifies the required geometry for the back of a book block.

Note: This table is not ordered alphabetically - it is ordered by the pressure required, lowest first.

Table A.59: TightBacking Enumeration Values

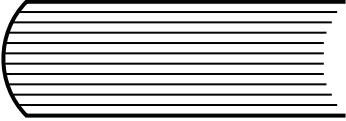
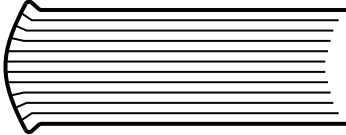
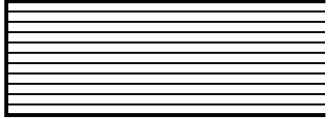
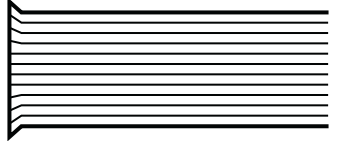
VALUES	DESCRIPTION	BOOK FORM
Round	Rounding way.	
RoundBacked	Rounding way, backing way.	
Flat	A flat backing - no tight backing is applied.	
FlatBacked	Backing way.	

A.3.59 Usage

Usage specifies how a resource SHALL be used by a process.

Table A.60: Usage Enumeration Values

VALUES	DESCRIPTION
Input	The resource SHALL be used as an input.
Output	The resource SHALL be used as an output.

A.3.60 WorkingDirection

WorkingDirection specifies the direction of an action or of the application of a resource.

Table A.61: WorkingDirection Enumeration Values

VALUES	DESCRIPTION
Bottom	From below.
Top	From above.

A.3.61 WorkStyle

WorkStyle specifies the style of working in a sheet fed press. It is defined in the press coordinate system, where the sheet moves parallel to the Y axis. In the simple case of a single unrotated page per surface this implies that a flip around the

Y-axis (WorkAndTurn, WorkAndBack) will result in head to head images for the back side, whereas a flip around the X-axis (WorkAndTumble) will result in head to foot images.

Table A.62: WorkStyle Enumeration Values

VALUE	DESCRIPTION	TURN AXIS	PLATE REUSE
Perfecting	This work style describes the printing on both sides of the substrate using a separate set of plates for each side. The front lay is altered by flipping the sheet along the X-axis and thus retaining the side lays. Note: Perfecting is geometrically very similar to WorkAndTumble. Note: Perfecting is most commonly used with in-press perfecting units but the sheets can also be flipped outside of the press. The name Perfecting was chosen mainly for backwards compatibility.	X-Axis	No
Simplex	No turning.	None	No
WorkAndBack	This work style describes the printing on both sides of the substrate with a different plate (set) in the second run. After the first run the side lays are altered but the front lays stay as they were. Lays can be turned by hand or using a pile reverser. Two plate sets are necessary for WorkAndBack. Note: WorkAndBack is geometrically very similar to WorkAndTurn.	Y-Axis	No
WorkAndTumble	The WorkAndTumble method is also used for perfecting. The leading edge of the print sheet changes as the sheet is turned, but the side lays remain unaltered. Tumbling happens after the first press run and the plate (set) may be used again in the second press run, imaging the other sheet surface. Note: WorkAndTumble SHOULD NOT be specified for digital printing.	X-Axis	Yes
WorkAndTurn	"WorkAndTurn" refers to the turning of the first-run sheet for subsequent perfecting. The front lays remain unchanged but the side lays SHALL be altered. The alteration can be made by hand or using a pile turner. Turning happens after the first press run and the plate (set) is used again in the second press run, imaging the other sheet surface. Note: WorkAndTurn SHOULD NOT be specified for digital printing.	Y-Axis	Yes
WorkAndTwist Deprecated in JDF 1.6	Done between two press runs. The sheets are twisted 180 degrees before the second run is performed so that the front lay and the side lay both change. The surface to be imaged is the same at both runs. Each run prints only part of the surface. The plate (set) stays in the machine. This work style is used for saving plate or film material. It is no longer a common work style.	Z-Axis	Yes

A.3.62 XYRelation

New in JDF 1.2

XYRelation specifies the relationship between two ordered numbers.

Table A.63: XYRelation Enumeration Values

VALUE	DESCRIPTION
eq	$X = Y$
ge	$X \geq Y$
gt	$X > Y$
le	$X \leq Y$
lt	$X < Y$
ne	$X \neq Y$

A.4 Preferred String and NMTOKEN Values

This section contains the preferred values for items of type string or NMTOKEN. Although these types are open lists, the values in these tables SHOULD be used where possible.

A.4.1 Comb and Coil Shapes

When specifying the shape of a comb or coil for **LooseBinding**, values from the following table are recommended.

Table A.64: Comb and Coil Shapes

VALUE	DESCRIPTION
Single	Each “tooth” is made with one wire.
SingleCalendar	Each “tooth” is made with one wire and an extension for hanging the bound product is provided in the center.
Twin	The shape of each “tooth” is made with a double wire (e.g., Wire-O®).
TwinCalendar	The shape of each “tooth” is made with a double wire and an extension for hanging the bound product is provided in the center.

A.4.2 Contact Types

Modified in JDF 1.4

When specifying the role of a contact, values from the following table are recommended.

Table A.65: Contact Types

VALUE	DESCRIPTION
Accounting	Contact information that relates to the invoice.
Administrator	Person to contact for queries concerning the execution of the job.
Agency New in JDF 1.4	The contact is an employee of an agency.
Approver New in JDF 1.2	The person who approves the job.
ArtDelivery	Delivery contact for artwork of the job.
ArtReturn	Return delivery contact for artwork of this job.
Author New in JDF 1.4	
Customer	The end customer.
Delivery	The delivery address for all products of the job.
DeliveryCharge	The contact who is charged for delivery of the job.
Designer New in JDF 1.4	
Editor New in JDF 1.4	
Employee New in JDF 1.6	Employee who works for the company processing the job.
Illustrator New in JDF 1.4	
Owner	The owner of a resource.
Photographer New in JDF 1.4	

Table A.65: Contact Types

VALUE	DESCRIPTION
Recipient New in JDF 1.6	The contact is a recipient of a variable data record.
Sender New in JDF 1.2	The source address of the delivery.
SenderAlias New in JDF 1.6	The sender address that SHALL be printed on a delivery to an end customer. Note: This allows a company that has contracted out the work to hide the subcontractor.
Supplier	Address of a supplier of required resources.
SurplusReturn	Return delivery or pickup address for surplus products of the job.
TelephoneSanitizer New in JDF 1.4	

A.4.3 Content Types

When specifying the type of content required or delivered, values from the following table are recommended.

Table A.66: Content Types

VALUE	DESCRIPTION
Ad	A single advertisement.
Article	A single article, including headers, text bodies, photos etc.
Barcode	A barcode.
ClassifiedAd	A classified advertisement.
ClassifiedPageElement	A grouping page element dealing with content of classified advertisements.
Composed	A combination of elements that define an element that is not bound to a document page.
Editorial	An element that contains editorial matter, e.g. text, photographs etc.
EditorialPageElement	A grouping page element dealing with content of the editorial department.
Graphic	An element that contains line art.
IdentificationField	A general identification field excluding bar codes.
Image	A bitmap image.
Page	A representation of one document page.
PageHeader	A page header. For instance a newspaper title shown on the front page of on each single page. Usually, these headers contain information such as page numbers, editorial desk and the dates.
ROPAd	An ROP advertisement, i.e. one that is placed by the planner. Generally speaking, in a newspaper environment, these include advertisements that are in color, that have placement requests (e.g. within the editorial section) or that are particularly large.
Surface	A representation of an imposed surface.
Text	Formatted or unformatted text.

A.4.4 Delivery Methods

Modified in JDF 1.5

Modification Note: The values were changed starting in **JDF 1.5**.

Delivery methods specify the recommended values for requesting how items are to be delivered.

Note: The data type of delivery methods is typically a string. However, it is strongly recommended to use an NMToken.

Table A.67: Delivery Methods

VALUE	DESCRIPTION
BestWay	The sender decides how to deliver.
CompanyTruck	
Courier	
CourierNoSignature New in JDF 1.5	A delivery service that does not require receipt stamps at the recipient's mailbox and/or mail room. This value is compatible with the commonly used Japanese 'Mail Bin' delivery service.
Email	
ExpressMail	
InstantMessaging New in JDF 1.5	
InterofficeMail	
Local New in JDF 1.5	The items are already in place, no other delivery process is required.
NetworkCopy New in JDF 1.5	This include LAN and VPN.
OvernightService Deprecated in JDF 1.5	
Storage	The item is stored by the supplier.
WebServer New in JDF 1.5	Upload/download from HTTP/FTP server.

A.4.5 Device Classes

CIP4 supports many device classes. The following values SHOULD be used when filling *Device/@DeviceClass*.

Table A.68: Device Classes (Sheet 1 of 3)

VALUE	DESCRIPTION
CaseMaker	A case maker produces the hard case for books. See ▶ Section 6.5.6 CaseMaking.
Controller New in JDF 1.6	A controller is a device that is a proxy for one or more individual devices or machines.
Cutter	A cutter can be used either to cut sheet blocks from a sheet fed press or to 'slit' a ribbon from a web fed press. See ▶ Section 6.5.13 Cutting.
DieCutter	A die cutter can be used to cut shapes from printed sheet blocks, e.g. windows in envelopes. See ▶ Section 6.5.36 ShapeCutting.
EndsheetFeeder	An end sheet feeder adds end sheets to a cover prior to binding. See ▶ Section 6.5.18 Feeding.
FilmSetter	A film setter creates a printable image on film. See ▶ Section 6.3.17 ImageSetting.

Table A.68: Device Classes (Sheet 2 of 3)

VALUE	DESCRIPTION
Folder	A folder can be used to fold the output from either sheet or web fed presses. See ▶ Section 6.5.19 Folding.
Gatherer	A gatherer can be used to collect sheets into piles. See ▶ Section 6.5.20 Gathering.
GathererBinder	A gatherer binder can be used to collect sheets into collated piles that are then bound. See ▶ Section 6.5.20 Gathering and ▶ Section 5.6.29 LooseBinding.
Hardcover	This device creates a hardcover. See ▶ Section 6.5.6 CaseMaking.
HardcoverBookLine	This device combines multiple processes to create and apply a hardcover to a block that it creates from a set of pages. See ▶ Section 6.5.2 BlockPreparation, ▶ Section 6.5.6 CaseMaking, ▶ Section 6.5.7 CasingIn, ▶ Section 6.5.10 Collecting, ▶ Section 6.5.11 CoverApplication, ▶ Section 6.5.17 EndSheetGluing, ▶ Section 6.5.20 Gathering, ▶ Section 6.5.21 Gluing, ▶ Section 6.5.22 HeadBandApplication, ▶ Section 6.5.25 Jacketing, ▶ Section 6.5.39 SpinePreparation and ▶ Section 6.5.40 SpineTaping.
HolePuncher	A hole puncher can be used to stamp or drill a number of holes, usually in a block of pages. See ▶ Section 6.5.23 HoleMaking.
Inserter	An inserter can be used to insert a component within another component. See ▶ Section 6.5.24 Inserting.
IntegratedDigitalPrinter	A digital printer that has additional post press capabilities, such as folding or binding. See ▶ Section 6.4.2 DigitalPrinting.
Jacketer	A jacketer wraps a bound book with a folded jacket. See ▶ Section 6.5.25 Jacketing.
MultipleWebConventionalPress	A multiple web conventional press. See ▶ Section 6.4.1 ConventionalPrinting.
PerfectBinder	This device combines multiple processes to create perfect bound books. See ▶ Section 6.5.2 BlockPreparation, ▶ Section 6.5.6 CaseMaking, ▶ Section 6.5.7 CasingIn, ▶ Section 6.5.10 Collecting, ▶ Section 6.5.11 CoverApplication, ▶ Section 6.5.17 EndSheetGluing, ▶ Section 6.5.20 Gathering, ▶ Section 6.5.21 Gluing, ▶ Section 6.5.22 HeadBandApplication, ▶ Section 6.5.25 Jacketing, ▶ Section 6.5.39 SpinePreparation and ▶ Section 6.5.40 SpineTaping.
PerfectBinderLine	This device combines multiple processes to create perfect bound books. See ▶ Section 6.5.2 BlockPreparation, ▶ Section 6.5.6 CaseMaking, ▶ Section 6.5.7 CasingIn, ▶ Section 6.5.10 Collecting, ▶ Section 6.5.11 CoverApplication, ▶ Section 6.5.17 EndSheetGluing, ▶ Section 6.5.20 Gathering, ▶ Section 6.5.21 Gluing, ▶ Section 6.5.22 HeadBandApplication, ▶ Section 6.5.25 Jacketing, ▶ Section 6.5.39 SpinePreparation and ▶ Section 6.5.40 SpineTaping.
PlateSetter	A plate setter creates a printable image on a plate suitable for conventional printing. See ▶ Section 6.3.17 ImageSetting.
PrintingPress	Any type of printing press. See ▶ Section 6.4.1 ConventionalPrinting and ▶ Section 6.4.2 DigitalPrinting.
Scanner	A scanner is used to describe the manual process of producing machine readable image data from pre-printed documents. See ▶ Section 6.2.5 ManualLabor.
SheetFedConventionalPress	A standard sheet fed conventional press. See ▶ Section 6.4.1 ConventionalPrinting.

Table A.68: Device Classes (Sheet 3 of 3)

VALUE	DESCRIPTION
SheetFedDigitalPrinter	A standard sheet fed digital press. See ▶ Section 6.4.2 DigitalPrinting.
SingleWebConventionalPress	A single web conventional press. See ▶ Section 6.4.1 ConventionalPrinting.
Stacker	A stacker can be used to create a pile or bundle of components suitable for delivery. See ▶ Section 6.5.41 Stacking.
Stitcher	A stitcher can be used to stitch a number of sheets together into a block and may also add a cover. See ▶ Section 6.5.43 Stitching.
ThreadSewer	A thread sewer can be used to sew a number of sheets together into a block. See ▶ Section 6.5.47 ThreadSewing.
Trimmer	A trimmer can be used to reduce a block to the required size, e.g. for subsequent hard-cover binding. See ▶ Section 6.5.48 Trimming.
WebDigitalprinter	A single web digital press. See ▶ Section 6.4.2 DigitalPrinting.
WideFormatPrinter	A wide format printer can be used to create large printed products such as banners. See ▶ Section 6.4.2 DigitalPrinting.

A.4.6 Flute Types

Values of this type define the required flute type (size and frequency) for corrugated media.

Although the classification of flutes using a letter code “A”, “B”, etc., are used very frequently (e.g., in the specification of the order for a box), there seems to be no agreement on the exact numerical specification of those categories. Slightly varying numbers for flute size and frequency can be found between regions (European versus US) and between vendors. See ▶ [Corrugated Packaging].

Table A.69: Flute Types

VALUE	DESCRIPTION
A	33±3 flutes/foot, 108±10 flutes/meter.
B	47±3 flutes/foot, 154±10 flutes/meter.
C	39±3 flutes/foot, 128±10 flutes/meter.
E	90±4 flutes/foot, 295±13 flutes/meter.
F	125±4 flutes/foot, 420±13 flutes/meter.

A.4.7 Fold Catalog

Fold catalog describes a type of fold according to the folding catalog in ▶ Figure A-1: Fold catalog . In case of any ambiguity, the folding notation SHALL take precedence over the graphic illustration in the aforementioned figure.

The value format is: "Fn-i" where “n” is the number of finished pages and “i” is either an integer, which identifies a particular fold, or the letter “X”, which identifies a generic fold (e.g., "F6-2" describes a Z-fold of 6 finished pages, and "F6-X" describes a generic fold with 6 finished pages).

Modification note: Starting with JDF 1.4, the option of using the letter "X" is provided for a generic fold.

Figure A-1: Fold catalog

F2-1 ↑1/2	F4-1 2x1 ↑1/2	F4-2 2x1 ↓1/2	F6-1 3x1 ↑1/3 ↓1/3	F6-2 3x1 ↓1/3 ↑1/3	F6-3 3x1 ↑1/4 ↑1/2
F6-4 3x1 ↑1/3 ↑1/3	F6-5 3x1 ↑2/3 ↓1/3	F6-6 3x1 ↑3/4 ↓1/4	F6-7 3x1 ↑1/4 ↓1/4	F6-8 3x1 ↑2/3 ↑1/3	F8-1 4x1 ↑1/2 ↑1/4
F8-2 4x1 ↑1/2 ↓1/4	F8-3 4x1 ↑1/4 ↓1/4 ↑1/4	F8-4 4x1 ↑1/4 ↑1/2 ↓1/4	F8-5 4x1 ↑1/4 ↑1/4 ↑1/4	F8-6 4x1 ↑3/4 ↓1/4 ↓1/4	F8-7 2x2 ↑1/2 + ↑1/2
F10-1 5x1 ↑1/5 ↓1/5 ↑1/5 ↓1/5	F10-2 5x1 ↑4/5 ↓1/5 ↓1/5 ↓1/5	F10-3 5x1 ↑2/5 ↓2/5 ↑1/5	F12-1 6x1 ↑1/3 ↓1/3 ↑1/6	F12-2 6x1 ↑1/3 ↑1/3 ↓1/6	F12-3 6x1 ↑1/2 ↓1/6 ↑1/6
F12-4 6x1 ↑1/2 ↓1/6 ↓1/6	F12-5 6x1 ↑1/2 ↓1/3 ↑1/6	F12-6 6x1 ↑1/6 ↓1/6 ↑1/6 ↓1/6 ↑1/6	F12-7 3x2 ↑1/3 ↓1/3 + ↑1/2	F12-8 3x2 ↑2/3 ↓1/3 + ↑1/2	F12-9 3x2 ↑1/3 ↓1/3 + ↑1/2
F12-10 3x2 ↑2/3 ↓1/3 + ↑1/2	F12-11 3x2 ↑1/3 + ↑1/2 + ↑1/3	F12-12 2x3 ↑1/2 + ↑2/3 ↓1/3	F12-13 2x3 ↑1/2 + ↑1/3 ↓1/3	F12-14 2x3 ↑1/2 + ↑1/3 ↓1/3	F14-1 7x1 ↑1/7 ↓1/7 ↑1/7 ↓1/7 ↑1/7 ↓1/7
F16-1 8x1 ↑1/2 ↓1/4 ↑1/8	F16-2 8x1 ↑1/2 ↓1/4 ↓1/8	F16-3 8x1 ↑1/2 ↑1/4 ↓1/8	F16-4 8x1 ↑1/2 ↑1/4 ↑1/8	F16-5 8x1 ↓1/8 ↑1/8 ↓1/8 ↑1/8 ↓1/8 ↑1/8 ↓1/8	F16-6 4x2 ↑1/2 + ↑1/2 + ↑1/4
F16-7 4x2 ↑1/2 + ↑1/2 + ↓1/4	F16-8 4x2 ↑1/2 + ↓1/2 + ↓1/4	F16-9 4x2 ↑1/2 ↓1/4 + ↑1/2	F16-10 4x2 ↑1/2 ↑1/4 + ↑1/2	F16-11 4x2 ↑1/4 ↓1/4 ↑1/4 + ↑1/2	F16-12 4x2 ↑1/4 ↑1/4 ↑1/4 + ↑1/2

Figure A-1: Fold catalog

<p>F16-13 2x4</p> <p>$\uparrow 1/2 + \uparrow 1/2 \downarrow 1/4$</p>	<p>F16-14 2x4</p> <p>$\uparrow 1/2 + \uparrow 1/2 \uparrow 1/4$</p>	<p>F18-1 9x1</p> <p>$\uparrow 1/9 \downarrow 1/9 \uparrow 1/9 \downarrow 1/9$ $\uparrow 1/9 \downarrow 1/9 \uparrow 1/9 \downarrow 1/9$</p>	<p>F18-2 9x1</p> <p>$\uparrow 2/3 \downarrow 1/3 \uparrow 1/9 \downarrow 1/9$</p>	<p>F18-3 9x1</p> <p>$\uparrow 1/3 \downarrow 1/3 \uparrow 2/9 \downarrow 1/9$</p>	<p>F18-4 9x1</p> <p>$\uparrow 1/3 \downarrow 1/3 \uparrow 1/9 \downarrow 1/9$</p>
<p>F18-5 3x3</p> <p>$\uparrow 1/3 \downarrow 1/3 + \uparrow 1/3 \downarrow 1/3$</p>	<p>F18-6 3x3</p> <p>$\uparrow 1/3 \downarrow 1/3 + \uparrow 2/3 \downarrow 1/3$</p>	<p>F18-7 3x3</p> <p>$\uparrow 1/3 \uparrow 1/3 + \uparrow 1/3 \downarrow 1/3$</p>	<p>F18-8 3x3</p> <p>$\uparrow 1/3 \uparrow 1/3 + \uparrow 2/3 \downarrow 1/3$</p>	<p>F18-9 3x3</p> <p>$\uparrow 2/3 \uparrow 1/3 + \uparrow 2/3 \uparrow 1/3$</p>	<p>F20-1 5x2</p> <p>$\uparrow 2/5 \downarrow 2/5 \uparrow 1/5 + \uparrow 1/2$</p>
<p>F20-2 5x2</p> <p>$\uparrow 1/5 \downarrow 1/5 \uparrow 1/5 \downarrow 1/5 + \uparrow 1/2$</p>	<p>F24-1 6x2</p> <p>$\uparrow 1/3 \downarrow 1/3 + \uparrow 1/2 + \uparrow 1/6$</p>	<p>F24-2 6x2</p> <p>$\uparrow 1/3 \uparrow 1/3 + \uparrow 1/2 + \uparrow 1/6$</p>	<p>F24-3 6x2</p> <p>$\uparrow 1/3 \downarrow 1/3 \uparrow 1/6 + \uparrow 1/2$</p>	<p>F24-4 6x2</p> <p>$\uparrow 1/3 \downarrow 1/3 \downarrow 1/6 + \uparrow 1/2$</p>	<p>F24-5 6x2</p> <p>$\uparrow 1/3 \uparrow 1/3 \downarrow 1/6 + \uparrow 1/2$</p>
<p>F24-6 6x2</p> <p>$\uparrow 1/6 \downarrow 1/6 \uparrow 1/6 \downarrow 1/6 + \uparrow 1/2$</p>	<p>F24-7 6x2</p> <p>$\uparrow 1/3 + \uparrow 1/2 + \uparrow 1/3 \downarrow 1/6$</p>	<p>F24-8 3x4</p> <p>$\uparrow 1/3 \downarrow 1/3 + \uparrow 1/2 \downarrow 1/4$</p>	<p>F24-9 3x4</p> <p>$\uparrow 2/3 \uparrow 1/3 + \uparrow 1/2 \downarrow 1/4$</p>	<p>F24-10 3x4</p> <p>$\uparrow 1/3 \uparrow 1/3 + \uparrow 1/2 \downarrow 1/4$</p>	<p>F24-11 4x3</p> <p>$\uparrow 1/2 + \uparrow 2/3 \downarrow 1/3 + \uparrow 1/4$</p>
<p>F28-1 7x2</p> <p>$\uparrow 1/7 \downarrow 1/7 \uparrow 1/7 \downarrow 1/7$ $\uparrow 1/7 \downarrow 1/7 + \uparrow 1/2$</p>	<p>F32-1 16x1</p> <p>$\uparrow 1/2 \uparrow 1/4 \uparrow 1/8 \downarrow 1/16$</p>	<p>F32-2 8x2</p> <p>$\uparrow 1/2 \uparrow 1/4 + \uparrow 1/2 + \uparrow 1/8$</p>	<p>F32-3 8x2</p> <p>$\uparrow 1/2 \downarrow 1/4 + \uparrow 1/2 + \downarrow 1/8$</p>	<p>F32-4 4x4</p> <p>$\uparrow 1/2 + \uparrow 1/2 + \uparrow 1/4 + \uparrow 1/4$</p>	<p>F32-5 4x4</p> <p>$\uparrow 1/2 + \uparrow 1/2 + \downarrow 1/4 + \downarrow 1/4$</p>
<p>F32-6 4x4</p> <p>$\uparrow 1/2 + \uparrow 1/2 + \uparrow 1/4 + \downarrow 1/4$</p>	<p>F32-7 4x4</p> <p>$\uparrow 1/4 \downarrow 1/4 \uparrow 1/4 + \uparrow 1/2 \downarrow 1/4$</p>	<p>F32-8 4x4</p> <p>$\uparrow 1/2 \downarrow 1/4 + \uparrow 1/2 \downarrow 1/4$</p>	<p>F32-9 4x4</p> <p>$\uparrow 1/2 + \uparrow 1/2 \downarrow 1/4 + \uparrow 1/4$</p>	<p>F36-1 9x2</p> <p>$\uparrow 1/3 \downarrow 1/3 \uparrow 1/9 \downarrow 1/9 + \uparrow 1/2$</p>	<p>F36-2 6x3</p> <p>$\uparrow 1/3 \downarrow 1/3 + \uparrow 1/3$ $\downarrow 1/3 + \uparrow 1/6$</p>
<p>F40-1 5x4</p> <p>$\uparrow 1/5 \downarrow 1/5 \uparrow 1/5$ $\downarrow 1/5 + \uparrow 1/2 \downarrow 1/4$</p>	<p>F48-1 6x4</p> <p>$\uparrow 1/3 \downarrow 1/3 + \uparrow 1/4$ $\downarrow 1/4 \uparrow 1/4 + \uparrow 1/6$</p>	<p>F48-2 4x6</p> <p>$\uparrow 1/4 \downarrow 1/4 \uparrow 1/4 + \uparrow 1/3$ $\downarrow 1/3 \uparrow 1/6$</p>	<p>F64-1 8x4</p> <p>$\uparrow 1/2 + \uparrow 1/4 \downarrow 1/4$ $\uparrow 1/4 + \uparrow 1/4 \downarrow 1/8$</p>	<p>F64-2 8x4</p> <p>$\uparrow 1/4 \downarrow 1/4 \uparrow 1/4 + \uparrow 1/4$ $\downarrow 1/4 \uparrow 1/4 + \uparrow 1/8$</p>	

Figure A-1: Fold catalog

Legend

- Fold up
- Fold down
- + Fold direction change, 90° (alternating)
- Finished format folded sheet
- 1, 2, 3 Folds in numeric order
- L Lay
- Green: open sheet length
- Red: open sheet width

Example: F32-3, 8x2

F32-3: Signature with 32 pages

8x2: Split: 8-sheet parts lengthwise, 2 sheet parts cross

↑1/2 Fold up with 1/2 of the open sheet format length

↓1/4 Fold down with 1/4 of the open sheet format length

+ : Fold direction change: 90° clockwise

↑1/2 Fold up with 1/2 of the open sheet format

+ : Fold direction change: 90° counterclockwise

↓1/8 Fold down with 1/8 of the open sheet format length

A.4.8 Ink and Varnish Coatings

When specifying coating types, such as ink or varnish, values from the following table are recommended.

Table A.70: Ink and Varnish Coatings (Sheet 1 of 2)

VALUE	DESCRIPTION
Aqueous	Water based coating.
DullUV Deprecated in JDF 1.6	
DullVarnish Deprecated in JDF 1.6	
Gloss New in JDF 1.6	A glossy coating.
GlossUV Deprecated in JDF 1.6	
GlossVarnish Deprecated in JDF 1.6	
Ink New in JDF 1.6	Any generic ink.
InkJet New in JDF 1.6	Ink.
Latex New in JDF 1.6	Liquid that is similar to ink.
Matte New in JDF 1.6	A matte coating.
None	No coating is requested.
Primer New in JDF 1.6	A coating that is applied beneath the image.
Protective Deprecated in JDF 1.6	
Relief New in JDF 1.6	Property of the coating.

Table A.70: Ink and Varnish Coatings (Sheet 2 of 2)

VALUE	DESCRIPTION
RubResistant New in JDF 1.6	Attribute of the ink.
Satin New in JDF 1.6	A coating between Gloss and Matte .
SatinUV Deprecated in JDF 1.6	
SatinVarnish Deprecated in JDF 1.6	
Silicone	Liquid that is similar to ink.
Toner New in JDF 1.6	Liquid that is similar to ink.
UV Modified in JDF 1.5	Ultra violet cured polymers.
Varnish	Unpigmented ink.
WaterResistant New in JDF 1.6	Attribute of the ink.

A.4.9 Input Tray and Output Bin Names

New in JDF 1.2

Location/*@LocationName* MAY be used to specify a location within a device (e.g., a paper tray). When specifying paper trays, the following locations are predefined. When specifying input paper trays (indicated with “I”) and/or output bins (indicated with “O”), the following values for **Location**/*@LocationName* locations are predefined. When specifying input tray names, the following values for **Location**/*@LocationName* are suggested. The input tray names that specify a position (e.g., Top) are identified by an asterisk (*). These positional input tray names SHOULD NOT be used if devices are clustered because the position of the input tray might not be the same for all of the devices in the cluster. (See ▶ Section 3.10.6.4 Locations of PhysicalResources for more details on the use of **Location**.)

Table A.71: Input Tray and Output Bin Names (Sheet 1 of 3)

VALUE	I/O	DESCRIPTION
AnyLargeFormat	IO	The location that holds larger format media with one dimension larger than 11 inches. The media dimensions SHALL be specified. "AnyLargeFormat" is defined for a PPD.
AnySmallFormat	IO	The location that holds smaller format media. The media dimensions SHALL be specified. "AnySmallFormat" is defined for a PPD.
AutoSelect	IO	The location that the device selects based on the Media specification.
Back	IO*	The value "Rear" is analogous; "Rear" SHOULD be used instead when possible.
Booklet	O	The bin where the device places booklets.
Bottom	IO*	The location that, when facing the device, can best be identified as 'bottom'.
BypassTray	I	The input tray used to handle odd or special papers. MAY be used to specify the input tray that is used for insert sheets that are not to be imaged.
BypassTray-N	I	The input tray used to handle odd or special papers. MAY be used to specify the input tray that is used for insert sheets that are not to be imaged. N = '1', '2', ...
Cassette	IO	The value "Tray-N" is analogous; "Tray-N" SHOULD be used instead when possible.
Center	—	The bin that, when facing the device, can best be identified as 'center.' Deprecated in JDF 1.2 — use "Middle" instead.

Table A.71: Input Tray and Output Bin Names (Sheet 2 of 3)

VALUE	I/O	DESCRIPTION
Continuous	IO	The location to handle continuous media (i.e., continuously connected sheets).
Disc	IO	The location to handle CD or DVD discs to be printed on.
Disc-N	IO	The location to handle CD or DVD discs to be printed on. N = '1', '2', ...
Envelope	IO	The location to handle envelopes.
Envelope-N	IO	The location to handle envelopes. N = '1', '2', ...
FaceDown	O	The bin that can best be identified as 'face down' with respect to the device.
FaceUp	O	The bin that can best be identified as 'face up' with respect to the device.
FitMedia	O	Requests the device to select a bin based on the size of the media.
Front	IO*	The location that, when facing the device, can best be identified as 'front.'
InsertTray	I	The input tray that can best be identified as 'insert tray.' Used to specify the input tray that is used for insert sheets (insert sheets are never imaged).
InsertTray-N	I	The input tray that can best be identified as 'insert tray-1', 'insert tray-2', ... etc. Used to specify the input tray that is used for insert sheets (insert sheets are never imaged).
LargeCapacity	IO	The location that can best be identified as the 'large capacity' location (in terms of the number of sheets) with respect to the device.
LargeCapacity-N	IO	The location that can best be identified as the 'large capacity-1', 'large-capacity-2', ... etc., input or output location (in terms of the number of sheets) with respect to the device.
Left	IO*	The bin that, when facing the device, can best be identified as 'left.'
Lower	IO*	The value "Bottom" is analogous; "Bottom" SHOULD be used instead when possible.
Mailbox-N	O	The output location that is best identified as "Mailbox #1", "Mailbox #2", etc.
Main	IO	The value "LargeCapacity" is analogous; "LargeCapacity" SHOULD be used instead when possible.
Middle	IO*	The location that, when facing the device, can best be identified as "middle".
MyMailbox	O	The job will be output to the bin that is best identified as "my mailbox"
PostMarkerInserter New in JDF 1.4	I	The input tray that is downstream of the marking engine and allows the user to pass media through a non-marking paper path for covers and/or inserts.
Rear	IO*	The location that, when facing the device, can best be identified as "rear".
Right	IO*	The location that, when facing the device, can best be identified as "right".
Roll	IO	The location to handle web-fed media.
Roll-N	IO	The Nth location to handle the Nth web-fed media.
Side	IO*	The location that, when facing the device, can best be identified as "side".
Stacker-N	O	The output location that is best identified as "Stacker #1", "Stacker #2", etc.
Top	IO*	The location that, when facing the device, can best be identified as "top".
Tray	IO	The location for a single tray device.
Tray-N	IO	The job will be output to the tray that is best identified as "Tray #1", "Tray #2", etc.

Table A.71: Input Tray and Output Bin Names (Sheet 3 of 3)

VALUE	I/O	DESCRIPTION
Upper	IO*	The value "Top" is analogous; "Top" SHOULD be used instead when possible.

A.4.10 MediaType Details

MediaType Details specifies additional details of the media to be used.

Table A.72: MediaType Details (Sheet 1 of 2)

VALUE	DESCRIPTION
Aluminum Modified in JDF 1.3	Conventional or CTP press plate.
Backlit New in JDF 1.5	Any media that is designed to be illuminated from the back side.
Cardboard	
CD New in JDF 1.3	CD disc to be printed on.
Cloth New in JDF 1.6	Cloth, e.g. for a hardcover book case.
Continuous	Continuously connected sheets of an opaque material. The edge that is connected is not specified.
ContinuousLong	Continuously connected sheets of an opaque material connected along the long edge.
ContinuousShort	Continuously connected sheets of an opaque material connected along the short edge.
CtPVisiblePhotoPolymer Dreprecated in JDF 1.3	Visible light CtP plate with photo polymer process.
CtPVisibleSilver Dreprecated in JDF 1.3	Visible light CtP plate with silver halide process.
CtPTermal Dreprecated in JDF 1.3	Thermal Ctp plate.
DoubleWall New in JDF 1.3	Double-wall corrugated board.
DryFilm	
DVD New in JDF 1.3	DVD disc to be printed on.
Envelope	Envelopes that can be used for conventional mailing purposes.
EnvelopePlain	Envelopes that are not preprinted and have no windows.
EnvelopeWindow	Envelopes that have windows for addressing purposes.
EnvelopeWindowLeft New in JDF 1.6	Envelopes that have windows on the left for addressing purposes.
EnvelopeWindowRight New in JDF 1.6	Envelopes that have windows on the right for addressing purposes.
FlexoBase New in JDF 1.4	For the base layer of flexo plates.
FlexoPhotoPolymer New in JDF 1.4	For the photopolymer layer of flexo plates.

Table A.72: MediaType Details (Sheet 2 of 2)

VALUE	DESCRIPTION
Flute	Flute layer of a corrugated board.
FullCutTabs	Media with a tab that runs the full length of the medium so that only one tab is visible extending out beyond the edge of non-tabbed media.
ImageSetterPaper	Contact paper as replacement for film.
Labels	Label stock, e.g. a sheet of peel-off labels.
Leather New in JDF 1.6	Leather stock, e.g. for a hardcover book case.
Letterhead	Separately cut sheets of an opaque material including a letterhead.
MultiLayer	Form medium composed of multiple layers that are attached to one another (e.g., for use with impact printers).
MultiPartForm	Form medium composed of multiple layers not attached to one another; each sheet might be drawn separately from an input source.
Photographic	Separately cut sheets of an opaque material to produce photographic quality images.
Polyester Modified in JDF 1.3	Conventional or CTP press plate.
PreCutTabs	Media with tabs that are cut so that more than one tab is visible extending out beyond the edge of non-tabbed media.
ScrimBanner New in JDF 1.5	Specific type of vinyl.
SingleFace New in JDF 1.3	Single-face corrugated board.
SingleWall New in JDF 1.3	Single-wall corrugated board.
Stationery	Separately cut sheets of an opaque material, includes generic paper.
TabStock	Media with tabs, either precut or full-cut.
Tractor	Tractor feed with holes.
Transparency	Separately cut sheets of a transparent material.
TripleWall New in JDF 1.3	Triple-wall corrugated board.
WallPaper New in JDF 1.5	Details of wall paper.
WetFilm	Conventional photographic film.

A.4.11 Milestones

The following table defines a list of values that are valid for [PageList/PageData/@PageStatus](#) and [Milestone/@MilestoneType](#). The column “JDF Process” specifies the [@Category](#) or [@Type](#) of the node that the [Milestone](#) applies to. “PageStatus” specifies whether the value MAY be used as [PageList/PageData/@PageStatus ContentList/@ContentStatus](#). “Milestone” specifies whether the value MAY be used as [Milestone/@MilestoneType](#).

Note: Milestones usually refer to events involving multiple objects, although the [Milestone/@MilestoneType](#) is specified as a singular. The scope of the [Milestone](#) is defined by the parent [Notification](#) element.

Table A.73: Message Events and Milestone Types (Sheet 1 of 2)

VALUE	JDF PROCESS	MILESTONE	PAGE STATUS	DESCRIPTION
Accepted	DigitalDelivery	—	Yes	The receiver acknowledged that the files are accessible for their destination.
BindingCompleted	—	Yes	Yes	All binding worksteps including packing of the job have been completed. Postpress worksteps are defined according to ▶ Section 6.5 Postpress Processes .
BindingInProgress	—	Yes	Yes	At least one of the binding worksteps of the job is in progress status.
Delivered	DigitalDelivery	Yes	Yes	The files were delivered to the destination.
DeviceStopped	All	—	—	The device that executes the workstep has been stopped.
DigitalArtArrived	—	Yes	Yes	Digital content has been received.
JobCompletedSuccessfully	All	Yes	Yes	Job completed successfully.
JobCompletedWithErrors	All	Yes	Yes	Job completed with errors.
JobCompletedWithWarnings	All	Yes	Yes	Job completed with warnings.
JobInProgress	All	Yes	Yes	Job is in progress.
PageApproved	—	Yes	Yes	Planned page proofs have been approved.
PageCompleted	—	Yes	Yes	Pages are ready (no further page processing or page proofing required).
PageDeleted	—	—	Yes	Specifies that the originally planned page was deleted. For instance, in the past, the page status was "PagePreliminary". Due to a reduction of the total number of pages, this specific page may have been deleted.
PagePlanned	—	Yes	Yes	Specifies that this page is ready for further processing. Its planning process is finished.
PagePreliminary	—	Yes	Yes	It is planned to produce this page, but its planning process is not finished yet.
PageProofed	—	Yes	Yes	Planned page proofs have been made
PDLProduced	All	Yes	Yes	Indicates that content data has been produced and is ready for production.
PostPressCompleted	—	Yes	Yes	All postpress worksteps including packing of the job have been completed. Postpress worksteps are defined according to ▶ Section 6.5 Postpress Processes .
PostPressInProgress	—	Yes	Yes	At least one of the postpress worksteps of the job is in progress status.
PrePressCompleted	—	Yes	Yes	All prepress worksteps of the job have been completed. Prepress worksteps are defined according to ▶ Section 6.3 Prepress Processes . In conventional prepress, this is the case when all plates have been made.
PrePressInProgress	—	Yes	Yes	At least one of the prepress worksteps of the job is in progress status.

Table A.73: Message Events and Milestone Types (Sheet 2 of 2)

VALUE	JDF PROCESS	MILESTONE	PAGE STATUS	DESCRIPTION
PressCompleted	—	Yes	Yes	All press worksteps of the job have been completed. Press worksteps are defined according to ▶ Section 6.4 Press Processes.
PressInProgress	—	Yes	Yes	At least one of the press worksteps of the job is in progress status.
ProofSent	—	Yes	Yes	Planned proofs sent to customer.
ShippingCompleted	Delivery	Yes	Yes	Final product was delivered to the customer or distributors.
ShippingInProgress	Delivery	Yes	Yes	Final product is being shipped.
SurfaceApproved	—	Yes	Yes	Planned imposition proofs have been approved.
SurfaceAssigned	—	Yes	Yes	Surfaces have their corresponding pages assigned (e.g., could be proofed).
SurfaceCompleted	—	Yes	Yes	Planned surfaces are ready (i.e., plates could be made).
SurfaceProofed	—	Yes	Yes	Planned imposition proofs have been made.

A.4.12 Module Types

The **ModuleStatus** element (see ▶ Table 5.105 ModuleStatus Element), the **ModulePhase** element (see ▶ Table 3.36 ModulePhase Element) and **VarnishingParams** (see ▶ Section 8.166 VarnishingParams) contain a **@ModuleType** attribute that defines individual modules within a machine. The following tables provide lists of individual **Module/@ModuleType** values.

Table A.74: Module Types for Conventional Printing

VALUE	DESCRIPTION
CoatingModule	Unit for coatings, for example, full coating of varnish.
Delivery	Delivery module, unit for gathering the printed sheets.
Drier	Module for drying the previously printed color or varnish.
ExtensionModule	Unit for extending the distance between modules, for example to increase the distance between the last printing module and the delivery module.
Feeder	Feeder module, feeds the device with paper.
Imaging	Imaging module in a direct to plate machine.
Numbering	Numbering unit.
PerfectingModule	Unit for perfecting, reversing device.
PrintModule	Unit for printing a color. Describes one cylinder and one side.

Table A.75: Module Types for Postpress (Sheet 1 of 2)

VALUE	DESCRIPTION
BlockPreparer New in JDF 1.4	The block preparer prepares the book block for a hardcover book. See ▶ Section 6.5.2 BlockPreparation.
BoxFolder New in JDF 1.4	The box folder folds and glues blanks into folded boxes for packaging. See ▶ Section 6.5.3 BoxFolding.

Table A.75: Module Types for Postpress (Sheet 2 of 2)

VALUE	DESCRIPTION
CaseMaker New in JDF 1.4	The case maker produces the hard case for books. See ▶ Section 6.5.6 CaseMaking.
Caser New in JDF 1.4	The caser joins the hardcover book case and the book block. See ▶ Section 6.5.7 CasingIn.
Chain New in JDF 1.2	The transport chain or conveyer to transport gathered / collected product.
EndSheetGluer New in JDF 1.4	The end sheet gluer merges the front end sheet, the book block and the back end sheet together. See ▶ Section 6.5.17 EndSheetGluing.
Feeder New in JDF 1.2	The feeder module, feeds the device with paper. See ▶ Section 6.5.18 Feeding.
Gluer New in JDF 1.4	The gluer applies glue to a component. See ▶ Section 6.5.21 Gluing.
HeadBandApplicator New in JDF 1.4	The head band applicator applies a head band to the book block. See ▶ Section 6.5.22 HeadBandApplication.
InkjetPrinter New in JDF 1.4	The printer that uses inkjet technology to print images or text on a component. See ▶ Section 6.4.2 DigitalPrinting.
Inserter New in JDF 1.4	The inserter inserts one or more “child” components to one “mother” component. See ▶ Section 6.5.24 Inserting.
Jacketer New in JDF 1.4	The jacketer wraps a jacket around a book. See ▶ Section 6.5.25 Jacketing.
PaperPath New in JDF 1.2	The paper path module, path that paper follows through the machine.
PressingStation New in JDF 1.4	The pressing station presses the cover to the book block.
ShapeCutter New in JDF 1.4	The shape cutter produces special shapes like an envelope window or a heart-shaped beer mat. Note: The shape cutter module may contain tools that correspond to the actual dies. See ▶ Section 6.5.36 ShapeCutting.
SpinePreparer New in JDF 1.4	The spine preparer prepares the spine of a book for hard and softcover production. See ▶ Section 6.5.39 SpinePreparation.
SpineTaper New in JDF 1.4	The spine taper applies a tape strip to the spine of a book block. See ▶ Section 6.5.40 SpineTaping.
Strapper New in JDF 1.4	The strapper straps a bundle of products. See ▶ Section 6.5.44 Strapping.
ThreadSealer New in JDF 1.4	The thread sealer sews and seals a signature at the spine. See ▶ Section 6.5.46 ThreadSealing.
ThreadSewer New in JDF 1.4	The thread sewer sews all signatures of a book block together. See ▶ Section 6.5.47 ThreadSewing.

Table A.76: Module Types for Digital Printing

VALUE	DESCRIPTION
FarmPrinter New in JDF 1.3	Individual printer in a printer farm of printers.
Fuser New in JDF 1.2	Fuser module — fuses the toner onto the media.
Marker New in JDF 1.4	Marker module, excluding in-line finishing.
MimeUnpacker New in JDF 1.4	Module that receives and unpacks the MIME package and fetches the JDF if it is referenced from the JMF .
ReferencedDataCollector New in JDF 1.4	Module that fetches data referenced from the JDF and MAY include data referenced from the PDL. Does not include accepting MIME, unpacking MIME, or fetching the JDF itself.
RIP New in JDF 1.4	Raster image processor module. See ▶ Section 6.3.33 RIPing.

Table A.77: Module Types for Web Printing

VALUE	DESCRIPTION
ChillUnit New in JDF 1.3	Chill unit that chills the heated printed paper.
ImprintUnit New in JDF 1.3	Printing unit that allows changing plates during a production run, doing imprints.
PrintUnit New in JDF 1.3	A print unit consists of multiple print module units.
Rollstand New in JDF 1.3	The roll stand feeds the web into the process-unit chain.
RemoisteningModule New in JDF 1.3	Module that can be used for high gloss varnish, re-moistened glue, rub-off ink or encapsulated fragrances. The re-moistening module is located between the last printing unit and the dryer.
UVCoater New in JDF 1.3	The UV-Coater module applies UV-varnish with subsequent drying in a UV-dryer.

Table A.78: Module Types for FolderSuperstructureWebPath (Sheet 1 of 2)

VALUE	DESCRIPTION
CrossCutter New in JDF 1.3	Cuts the web/ribbon n-times into sheets and transports the sheets to inline postpress equipment.
Delivery New in JDF 1.3	Delivers the printed and/or folded sheets out of the folder.
Folder New in JDF 1.3	Module for cutting the collected ribbons into sheets, in some cases collecting these sheets, and folding the sheets (quarter and cross folds).
Former New in JDF 1.3	Module for gathering ribbons and in most instances doing the first fold of the ribbons (quarter fold).
GluingAndSofteningModule New in JDF 1.3	Consists of multiple heads, spread out in the press for gluing and/or softening of ribbons or folded sheets.

Table A.78: Module Types for FolderSuperstructureWebPath (Sheet 2 of 2)

VALUE	DESCRIPTION
MoebiusDeinfiniteizer New in JDF 1.3	Used to resolve the infinite loops caused by printing on interleaving surfaces of Möbius banded webs.
PerforatingModule New in JDF 1.3	Module for doing cross, longitudinal or diagonal perforations and die cuts on a web. The module is placed between chill unit and folder.
PlanoModule New in JDF 1.3	The plano module cuts the web/ribbon into sheets and stacks the sheets into a pile.
PloughFoldModule New in JDF 1.3	The plough fold module does a quarter fold to ribbons or webs and is mostly found in front of a folder module.
Rewinder New in JDF 1.3	Rewinds the printed web to a roll.
RibbonCompensator New in JDF 1.3	Controls the web's or ribbon's running direction regarding the cross cut.
Slitter New in JDF 1.3	Module for cutting in the machine direction.
Stitcher New in JDF 1.3	Stitches folded sheets together.
Superstructure New in JDF 1.3	Module in which a web will be cut into ribbons that will then be moved to the correct position for folding.
TurnerBar New in JDF 1.3	Turns the front side of a web to the back side and vice versa.
TurnerBarUnit New in JDF 1.3	Turns the front side of a web to the back side and vice versa in a separate unit.

Table A.79: Module Types for PostPressComponentPath Web Printing Devices

VALUE	DESCRIPTION
BundlingModule New in JDF 1.3	The bundling module is used for bundling components. See ▶ Section 6.5.5 Bundling.
LabelingModule New in JDF 1.3	The labeling module is used for labeling a bundle. See ▶ Section 6.5.26 Labeling.
PalletizingModule New in JDF 1.3	The palletizing module collects the bundles on a pallet. See ▶ Section 6.5.30 Palletizing.
PrintRoll New in JDF 1.3	The print roll is used for rolling components. See ▶ Section 6.5.33 PrintRolling.
Stacker New in JDF 1.3	The stacker module stacks the component into a pile. See ▶ Section 6.5.41 Stacking.
Trimmer New in JDF 1.3	The trimmer module trims the component to its final size. See ▶ Section 6.5.48 Trimming.

A.4.13 Node Categories

Node categories are used to indicate the general purpose of a **JDF** node.

Table A.80: Node Categories

VALUE	DESCRIPTION
Binding	Binding of a bound product.
Cutting New in JDF 1.3	Specifies cutting of a Component .
DigitalPrinting	A RIP and print run on a digital printer that produces final output.
FinalImaging	A RIP and image that produces final output that is ready for further processing (e.g., film or plates).
FinalRIPing	A RIP process for generating final output.
Folding	Folding of a product.
Newsprinting New in JDF 1.4	A press run on a news printing web press.
PostPress	General postpress. Includes "Folding" and "Binding".
PrePress	General prepress.
Printing	A press run that produces final output.
ProofImaging	A RIP that produces proof output.
ProofRIPing	A RIP process for generating a proof. The processes are identical to those specified for "FinalRIPing".
PublishingPreparations New in JDF 1.3	Preparing an issue of a newspaper or magazine to be published.
RIPing New in JDF 1.3	General RIP gray box. For details, see RIPing .
WebPrinting	A press run on a web press can produce one or more components as output at the same time. A web printing press might be equipped with prepress and postpress equipment.
WebToPrint	A product description that describes a product order in a web shop.

A.4.14 Notification Details

The **Notification** element is used for messaging and logging of events. It is defined in ▶ Section 3.11.4.5 Notification. Notifications are grouped into five classes: "Event", "Information", "Warning", "Error" and "Fatal". For more about **Notification** classes, see **Notification/@Class** in ▶ Table 3.11.4.5 Notification. In addition to the classes, the **@Type** attribute and **Abstract NotificationDetails** element provide a container for detailed information about the notification.

Elements derived from the **Abstract NotificationDetails** element represent a structured and extensible data type. The structure of various predefined **Notification Details** types and their descriptions are listed in the following sections.

A.4.14.1 Abstract NotificationDetails

The **Abstract NotificationDetails** element is empty.

Table A.81: Abstract NotificationDetails

NAME	PAGE	DESCRIPTION

A.4.14.2 Notification Details

► Table A.82 List of Notification Details Elements defines the elements that are derived from the **Abstract NotificationDetails** element. The value of **Notification/@Type** is the same as the element name for the corresponding **Notification/Notification Details**.

Table A.82: List of Notification Details Elements

NAME	PAGE	DESCRIPTION
Barcode	page 780	A bar code has been scanned
FCNKey	page 780	A function key has been activated at a console.
SystemTimeSet	page 780	The system time of a device/Controller/Agent has been set.
CounterReset	page 780	The production counter of a device has been reset.
Error	page 781	This element provides additional information for common errors.
Event	page 781	This element provides additional information for common events.
Milestone	page 781	Tracks certain overall milestones concerning the entire job across all resources and processes.

A.4.14.2.1 Barcode

A bar code has been scanned.

Table A.83: Barcode Element

NAME	DATA TYPE	DESCRIPTION
Code	string	Contains the scanned bar code.

A.4.14.2.2 FCNKey

A function key has been activated at a console.

Table A.84: FCNKey Element

NAME	DATA TYPE	DESCRIPTION
Key	integer	Contains the number of that function key.

A.4.14.2.3 SystemTimeSet

The system time of a device/Controller/Agent has been set (e.g., readjusted, changed to daylight saving time, etc.).

Table A.85: SystemTimeSet Element

NAME	DATA TYPE	DESCRIPTION
NewTime	dateTime	Contains the new time.
OldTime ?	dateTime	Contains the old time.

A.4.14.2.4 CounterReset

The production counter of a device has been reset.

Table A.86: CounterReset Element

NAME	DATA TYPE	DESCRIPTION
CounterID ?	string	Identification of the counter that has been set.
LastCount ?	integer	Last counter value before reset.

A.4.14.2.5 Error

This element provides additional information for common errors.

Table A.87: Error Element

NAME	DATA TYPE	DESCRIPTION
<i>ErrorID</i> ? Modified in JDF 1.3	string	Internal error ID of the application that declares the error.
<i>Resend</i> ? New in JDF 1.3	enumeration	Expected re-sending policy to fix the error. Allowed values are: Required – A corrected version of the offending JMF SHALL be resent. Prohibited – A corrected version of the offending JMF SHALL NOT be resent.
<i>ReturnCode</i> ? New in JDF 1.2	integer	JDF defined return code for an error. See ▶ Section C Return Values.
<i>ErrorData</i> * New in JDF 1.3	element	Additional details of the error.

A.4.14.2.6 ErrorData

This element provides additional information for locating errors.

Table A.88: ErrorData Element

NAME	DATA TYPE	DESCRIPTION
<i>ErrorType</i>	enumeration	Details of the error of the attribute or element specified in <i>@Path</i> . Allowed values are: Invalid – the attribute or element has an invalid value. Missing – the attribute or element is missing. Unsupported – the attribute or element is not known by the receiver.
<i>ErrorURL</i> ?	URL	URL of the referenced entity (e.g., JDF or PDL) where the error occurred. If not specified, the error occurred in the received JMF .
<i>FixExpression</i> ?	regExp	Expression that defines the acceptable valid values for the attribute defined by <i>@Path</i> . <i>@FixExpression</i> SHALL NOT be specified if <i>@Path</i> specifies an element.
<i>Path</i> ?	XPath	XPath location of the erroneous attribute or element in the offending JMF or referenced file. If <i>@ErrorURL</i> is specified, <i>@Path</i> refers to the XML that is referenced by <i>@ErrorURL</i> , otherwise it refers to the JMF that caused the error. <i>@Path</i> SHALL NOT be specified if <i>@ErrorURL</i> references a format other than XML.

A.4.14.2.7 Event

New in JDF 1.2

This element provides additional information for common events.

Table A.89: Event Element

NAME	DATA TYPE	DESCRIPTION
<i>EventID</i>	string	Internal event ID of the application that emits the event.
<i>EventValue</i> ?	string	Additional user defined value related to this event.

A.4.14.2.8 Milestone

New in JDF 1.3

In addition to the concrete **JMF** feedback both from production to MIS and MIS to production with respect to finished processes (see ▶ Section 5.55 Status) and available/consumed resources (see ▶ Section 5.46 Resource), many actors in the workflow want to track certain overall milestones concerning the entire job across all resources and processes, in order to display this to the operator. Sometimes the **JMF** recipients cannot determine these milestones from the detailed **JDF/JMF**. Therefore a more abstract representation of job status is described by *Milestone* events.

Note: *Milestone* elements usually refer to events involving multiple objects, although the *Milestone/@MilestoneType* is specified as a singular event. The scope of the *Milestone* is defined by the parent *Notification* element.

Table A.90: Milestone Element

NAME	DATA TYPE	DESCRIPTION
<i>MilestoneType</i>	NMTOKEN	Type of <i>Milestone</i> . Values include those from: ▶ Milestones.
<i>TypeAmount</i> ?	integer	Indication of how many elements have been processed (if the milestone refers to certain resources) (e.g., number of pages proofed, number of different printed sheets (not the cumulative amount)).

Example A.49: Milestone in JMF

```
<JMF SenderID="WorkflowController" TimeStamp="2005-07-25T12:32:48+02:00"
  Version="1.6" xmlns="http://www.CIP4.org/JDFSchema_1_1" xmlns:xsi="http://www.w3.org/2001/
XMLSchema-instance">
  <Signal ID="S1" Type="Notification" xsi:type="SignalNotification">
    <Notification Class="Event" JobID="myJobID"
      TimeStamp="2005-05-25T12:32:48+02:00" Type="Milestone">
      <Comment>All Proofs sent to customer</Comment>
      <Milestone MilestoneType="ProofSent" TypeAmount="24"/>
    </Notification>
  </Signal>
</JMF>
```

A.4.15 Pallet Types

The following table defines a list of values that are valid for indicating the intended type of pallet to be used.

Table A.91: Pallet Types

VALUE	DESCRIPTION
2Way	Two-way entry.
4Way	Four-way entry.
Euro	Standard 1m x 1m Euro pallet. Deprecated in JDF 1.4
Euro800x600	800mm x 600mm. See ▶ [DIN 15146-4] - equals half Euro pallet. New in JDF 1.4
Euro800x1200	800mm x 1200mm. See ▶ [DIN EN 13698-1] - equals Euro pallet. New in JDF 1.4
Euro1000x1200	1000mm x 1200mm. See ▶ [DIN EN 13698-2] - flat pallet. New in JDF 1.4
Euro1200x1200	1200mm x 1200mm, no norm, but used in the field. New in JDF 1.4

A.4.16 Printing Technologies

The following table defines a list of values that are valid for indicating the intended printing technology to be used.

Table A.92: Printing Technologies (Sheet 1 of 2)

VALUE	DESCRIPTION
DyeSublimation	For digital printing.
Electrostatic	For digital printing.
Flexo	For conventional printing.
Gravure	For conventional printing.
Inkjet	For digital printing.
Laser	For digital printing.
Latex	Specific type of inkjet. New in JDF 1.5

Table A.92: Printing Technologies (Sheet 2 of 2)

VALUE	DESCRIPTION
Letterpress	Conventional printing with traditional relief masters.
Offset	For conventional printing.
Screen	For conventional printing.
Thermal	For digital printing.
UV	For digital printing. New in JDF 1.5

A.4.17 PrintStandard Characterization Data Sets

PrintStandard specifies the reference name of a characterization data set. There are research and trade associations (such as Fogra, IDEAlliance, WAN-IFRA, JPMA, ICC) that provide characterization data sets for standard printing conditions. Most reference names of standard printing conditions are registered with the ICC; see ▶ [Characterization Data].

Official reference names SHALL be taken if a standard printing condition exists. Custom or device dependent reference names MAY be provided if no official standard printing condition is available.

Note: In digital printing, PrintStandard will typically be used to specify the selected internal color model that defines the device specific use of colorants such as light cyan or additional gamut colors.

Note: Whereas PrintStandard defines a media independent characterization data set, *Part/@PrintCondition* defines a characterization data set that is applied to a specific setup including paper selection and screening setup.

Table A.93: PrintStandard Values

PRINTSTANDARD NAME	PROVIDER	DESCRIPTION
CGATS21-2-CRPC5	International Color Consortium	Valid for CGATS21-2-CRPC5 based profiles such as “SWOP2013C3-CRPC5”. See ▶ [CGATS.21].
CGATS21-2-CRPC6	International Color Consortium	Valid for CGATS21-2-CRPC6 based profiles such as “SWOP2013C3-CRPC5”. See ▶ [CGATS.21].
FOGRA39	FOGRA	Valid for FOGRA39L based profiles such as “ISO Coated v2 (ECI)” or “ISO Coated v2 300% (ECI)”. See ▶ [FOGRA].
FOGRA47	FOGRA	Valid for FOGRA47L based profiles such as “PSO Uncoated ISO 12647 (ECI)”. See ▶ [FOGRA].
FOGRA51	FOGRA	Valid for FOGRA51 based profiles such as “PSO Coated v3”. See ▶ [FOGRA].
FOGRA52	FOGRA	Valid for FOGRA52 based profiles such as “PSO Uncoated v3”. See ▶ [FOGRA].
FOGRA53	FOGRA	Valid for FOGRA53 based profiles such as “eciCMYK”. See ▶ [FOGRA].

A.4.18 Process Usage

Table A.94: Process Usage (Sheet 1 of 2)

VALUE	DESCRIPTION
Accepted	Used for Resource in an output resource of Approval .
Application	Used for Component in an input resource of BoxFolding .
BackEndSheet	Used for Component in an input resource of EndSheetGluing .
Book	Used for Component in an input resource of Jacketing .
BookBlock	Used for Component in an input resource of ChannelBinding , EndSheetGluing and RingBinding .
Box	Used for Component in an input resource of BoxPacking .

Table A.94: Process Usage (Sheet 2 of 2)

VALUE	DESCRIPTION
Case	Used for Component in an input resource of CasingIn .
Child	Used for Component in an input resource of Inserting .
Cover	Used for Component in an input resource of ChannelBinding and CoverApplication .
CoverBoard	Used for Media in an input resource of CaseMaking .
CoverMaterial	Used for Component and Media in an input resource of CaseMaking .
Cylinder	Used for ExposedMedia in an input resource of ConventionalPrinting .
Document	Used for RunList in an input resource of Imposition , LayoutPreparation and Stripping and used for RunList in an output resource of Stripping .
FrontEndSheet	Used for Component in an input resource of EndSheetGluing .
Good	Used for Component in an output resource of ConventionalPrinting and DigitalPrinting .
Input	Used for Component in an input resource of ConventionalPrinting and DigitalPrinting .
Jacket	Used for Component in an input resource of Jacketing .
Label	Used for Component in an input resource of Labeling .
Marks	Used for RunList in an input resource of Imposition , LayoutPreparation and Tiling , and used for RunList in an output resource of LayoutPreparation and Stripping .
Mother	Used for Component in an input resource of Inserting .
Plate	Used for ExposedMedia in an input resource of ConventionalPrinting .
Proof	Used for Component in an input resource of ConventionalPrinting and DigitalPrinting , and used for ExposedMedia in an input resource of ConventionalPrinting .
Rejected	Used for Resource in an output resource of Approval .
RingBinder	Used for Component in an input resource of RingBinding .
SpineBoard	Used for Media in an input resource of CaseMaking .
Surface	Used for RunList in an input resource of Tiling .
Tie	Used for Media in an input resource of BoxPacking .
Underlay	Used for Media in an input resource of BoxPacking .
Waste	Used for Component in an output resource of ConventionalPrinting and DigitalPrinting .

A.4.19 Product Types

Table A.95: Product Types (Sheet 1 of 3)

VALUE	DESCRIPTION
BackCover	The last page or sheet of a softcover book or magazine, commonly a heavier media.
BlankBox New in JDF 1.3	Cut, Unfolded box, input for folder-gluer
BlankSheet New in JDF 1.4	An unprinted divider page or sheet. Also describes die-cut unprinted label.
BlankWeb New in JDF 1.4	A web with connected blanks after a die cutting.

Table A.95: Product Types (Sheet 2 of 3)

VALUE	DESCRIPTION
Body New in JDF 1.2	Generic content inside of a cover, e.g. "BookBlock". Also, in page assembly, the main text content (body copy), in contrast to headings or front matter.
Book	Body with a cover and a spine.
BookBlock	The assembled body of pages for a hardcover book.
BookCase	The assembled covers and spine component of a hardcover book, prior to "casing in" (attaching to the book block).
Booklet New in JDF 1.6	Body with a cover without a spine (typically stapled).
Box	Convenience packaging that is not envisioned to be protection for shipping.
Brochure	A single folded sheet.
BusinessCard	A small card that displays contact information for an individual employed by a company.
Carton	Protection packaging for shipping.
Cover	A single sheet covering a side of a print product.
CoverLetter New in JDF 1.6	A letter accompanying another print product.
EndSheet New in JDF 1.5	A glued sheet that spans and attaches BookBlock to BookCase , in both front and back of a hardcover book, (printed or not).
Envelope New in JDF 1.6	A folded paper container, with sealable flap, that encloses and protects a document or contents.
FlatBox New in JDF 1.3	A folded and glued blank (not opened). Output from a box folder-gluer.
FlatWork New in JDF 1.5	Non-bound, non-folded products or products that only have packaging folds.
FrontCover	The first page or sheet of a softcover book or magazine, commonly a heavier media.
Insert New in JDF 1.2	A product part intended to be inserted into a print product.
Jacket	Hardcover case jacket.
Label	A piece of paper or plastic that is attached to an object in order to give information about it.
Leaflet New in JDF 1.6	A single unfolded sheet.
Letter New in JDF 1.6	A written or printed communication addressed to a person or organization and usually transmitted by mail or messenger.
Map New in JDF 1.6	A drawing/representation of a particular area such as a city, or a continent, showing its main features, as they would appear if viewed from above.
Media New in JDF 1.6	Unprinted media, the substrate (usually paper) on which an image is to be printed.
Newspaper New in JDF 1.3	A newspaper-product

Table A.95: Product Types (Sheet 3 of 3)

VALUE	DESCRIPTION
Notebook New in JDF 1.6	A book or block with a set of identical or similar pages, e.g. a writing tablet, where all page fronts have identical content, and all page backs have identical content.
Pallet New in JDF 1.3	Loaded pallet of boxes, cartons or Component resources.
Postcard New in JDF 1.6	A card designed for sending a message by mail without an envelope.
Poster	A large printed picture.
Proof New in JDF 1.6	A representation that visualizes the intended output of page assembly, or the printing process.
ResponseCard New in JDF 1.6	A self mailer to respond to an offer.
Section New in JDF 1.6	Main division of a book, such as a chapter, typically with a name or number.
SelfMailer New in JDF 1.6	A document to be sent via the post without an additional envelope.
Spine New in JDF 1.6	The bound edge of a book. Also, the portion of the cover that connects the front and back cover, wrapping the binding edge.
Stack New in JDF 1.4	Stacked Component .
Unknown Deprecated in JDF 1.2	
WrapAroundCover New in JDF 1.6	A single cover sheet containing the front cover, spine and back cover.

A.4.20 Service Levels

Table A.96: Service Levels

VALUE	DESCRIPTION
2nd Day Air	
Ground	
Next Day	

A.4.21 Spine Operations

Table A.97: Spine Operations (Sheet 1 of 2)

VALUE	DESCRIPTION
Brushing	Brushes away dust from the spine to improve the binding quality.
FiberRoughing	The fibers of the paper on the spine are exposed without the risk of glazing the paper coating. This optimizes the spine preparation considering paper and adhesive types.
Leveling	After milling the spine, any uneven areas are leveled to achieve an even surface.
Milling	Cuts off part of the spine so the spine is not too even. A rough texture of the fibers is assured. This creates ideal conditions for stable anchoring of the sheets in the glue.

Table A.97: Spine Operations (Sheet 2 of 2)

VALUE	DESCRIPTION
Notching	This gives a clamping effect on the spine that is desirable for some products.
Sanding	Used for voluminous book papers.
Sealing New in JDF 1.6	Apply heat to a spine of a book that contains signatures that have been prepared by ThreadSealing .
Shredding	Produces a relatively smooth surface. Further operations like "Notching", "Leveling", "FiberRoughing", "Sanding" or "Brushing" are necessary.

A.4.22 Status Details

The `@StatusDetails` attribute refines the concept of a job status to be job specific or a device status to be device specific. The following tables define individual `@StatusDetails` values and map them to the appropriate job specific state `JDF/@Status` or device specific state `DeviceInfo/@DeviceStatus`.

Note: `JDF/@Status` = "Setup", "Cleanup" and "Stopped" can include the description of a device with no job assigned to it.

A.4.22.1 Status Details for Generic Devices

Table A.98: Status Details Mapping for Generic Devices (Sheet 1 of 3)

STATUS DETAILS	JDF/ @STATUS	DEVICESTAT US	DESCRIPTION
AbortedBySystem New in JDF 1.3	Aborted	Stopped	The job is being or has been aborted by the device.
BreakDown	Stopped	Offline	Breakdown of the device, repair needed.
Calibrating	Setup	Production	The device is calibrating, either manually or automatically.
ControlDeferred Modified in JDF 1.4	-	Offline	The machine is not accessible by the device. Note: <code>JDF/@Status</code> is unknown if the device is not accessible. Modification note: Starting with JDF 1.4 , the <code>@DeviceStatus</code> value changed from "Stopped" to "Unknown".
CoverOpen New in JDF 1.3	Stopped	Stopped	One or more covers on the device are open.
DocumentAccessError New in JDF 1.3	Aborted	Stopped	The device could not access one or more documents passed by reference.
DoorOpen New in JDF 1.3	Stopped	Stopped	One or more doors on the device are open.
Failure	Stopped	Stopped	Failure of the device. Requires some maintenance in order to restart the device. "Failure" has specialized subcategories: "PaperJam", "DoubleFeed", "BadFeed", "BadTrim", "ObliqueSheet", "IncorrectComponent", "IncorrectThickness".
Good	InProgress	Production	Production of products in progress, good copy counter is on, waste copy counter is off.
Idling	Stopped	Production	Device is running, but no products are produced or consumed. Good and waste copy counters are off.
InputTrayMissing New in JDF 1.3	Stopped	Stopped	One or more input trays are not in the device.
InterlockOpen New in JDF 1.3	Stopped	Stopped	One or more interlock devices on the printer are unlocked.

Table A.98: Status Details Mapping for Generic Devices (Sheet 2 of 3)

STATUS DETAILS	JDF/ @STATUS	DEVICESTATUS	DESCRIPTION
IterationPaused New in JDF 1.4	Suspended	Production	At least one iteration cycle has completed but additional iteration cycles MAY still occur.
JobCanceledByOperator New in JDF 1.3	Aborted	Production	The job was canceled by the device operator using AbortQueueEntry , or means local to the device.
JobCanceledByUser New in JDF 1.3	Aborted	Production	The job was canceled by the owner of the job using AbortQueueEntry .
JobCompletedSuccessfully New in JDF 1.3	Completed	Production	The job completed successfully.
JobCompletedWithErrors New in JDF 1.3	Completed	Production	The job completed with errors (and possibly warnings too).
JobCompletedWithWarnings New in JDF 1.3	Completed	Production	The job completed with warnings.
JobHeld New in JDF 1.3	Waiting	Production	The device held the job that had been waiting (by performing a HoldQueueEntry request on a waiting QueueEntry).
JobHeldOnCreate New in JDF 1.3	Waiting	Production	The job was submitted to the queue with the Queue/@Status = "Held", the job's QueueSubmissionParams/@Held = "true", or JDF/@Activation = "Held".
JobIncoming New in JDF 1.3	Waiting	Production	The device is retrieving/accepting document data.
JobResuming New in JDF 1.3	Waiting	Production	The device is in the process of moving the job from a suspended condition to a candidate for processing (ResumeQueueEntry).
JobScheduling New in JDF 1.3	Waiting	Production	The device is scheduling the job for processing.
JobStreaming New in JDF 1.3	InProgress	Production	Same as "JobIncoming" with the specialization that the device is processing the document data as it is being received (that is, the job data is not being spooled, but rather is being processed in chunks by the output device and is being imaged during reception).
JobSuspended New in JDF 1.3	Suspended	Production	The device suspended the job that had been processing (e.g., by performing a SuspendQueueEntry request on a running QueueEntry) and other jobs can be processed by the device.
JobSuspending New in JDF 1.3	InProgress	Production	The device is in the process of moving the job from a processing condition to a suspended condition where other jobs can be processed.
Maintenance	Stopped	Stopped	General maintenance of the device. "Maintenance" has specialized subcategories: "BlanketChange" and "SleeveChange".
MissResources	Stopped	Stopped	Production has been stopped because resources are missing or unavailable. Waits for new resources; subcategory of "Pause".
MovingToPaused New in JDF 1.3	InProgress	Production	The device has been paused, but the machine(s) are taking an appreciable time to stop.

Table A.98: Status Details Mapping for Generic Devices (Sheet 3 of 3)

STATUS DETAILS	JDF/ @STATUS	DEVICESTAT US	DESCRIPTION
OutputAreaFull New in JDF 1.3	Stopped	Stopped	One or more output areas are full (e.g., tray, stacker, collator).
OutputTrayMissing New in JDF 1.3	Stopped	Stopped	One or more output trays are not in the device.
PaperJam	Stopped	Stopped	Media jam in the device; subcategory of "Failure".
Pause	Stopped	Stopped	Machine paused; restart is possible. "Pause" has specialized subcategories: "MissResources" and "WaitForApproval".
ProcessingToStopPoint New in JDF 1.3	InProgress	Production	The requester has issued an AbortQueueEntry request or the device has aborted the job, but is still performing some actions on the job until a specified stop point occurs or job termination/cleanup is completed.
Repair	Stopped	Offline	The device is being repaired after a break down.
ShutDown	Stopped	Offline	Machine stopped (can be switched off), restart requires a run up.
SizeChange	Setup	Production	Changing setup for media size.
StandBy	-	Idle	The device has been switched into power save mode and is still accepting new jobs.
StandBy	-	Offline	The device has been switched into power saving mode and cannot process jobs without prior intervention such as Command[@Type="WakeUp"] .
WaitForApproval	Stopped	Stopped	Production has been stopped because a necessary approval is still missing; subcategory of "Pause".
WarmingUp	Setup	Production	Device is warming up after power up or power saver mode wake-up.
Waste	InProgress	Production	Production of products in progress, good copy counter is off, waste copy counter is on.
WasteFull	Stopped	Stopped	The device waste receptacle is full.

A.4.22.2 Status Details for Printing Devices

Table A.99: Status Details Mapping for Printing Devices (Sheet 1 of 2)

STATUS DETAILS	JDF/ @STATUS	DEVICESTAT US	DESCRIPTION
BlanketChange	Stopped	Stopped	Changing of blankets; subcategory of "Maintenance" (e.g., a 'specialization').
BlanketWash	Cleanup	Production	Washing of the blanket; subcategory of "WashUp".
CleaningInkFountain	Cleanup	Production	Cleaning of the ink fountain; subcategory of "WashUp".
CylinderWash	Cleanup	Production	Washing of impression cylinders; subcategory of "WashUp".
DampeningRollerWash	Cleanup	Production	Washing of the dampening roller; subcategory of "WashUp".
FormChange	Setup	Production	In conventional printing, changing of plates; in direct imaging printing, imaging or re-imaging of plates.

Table A.99: Status Details Mapping for Printing Devices (Sheet 2 of 2)

STATUS DETAILS	JDF/ @STATUS	DEVICESTAT US	DESCRIPTION
InkRollerWash	Cleanup	Production	Washing of the inking roller; subcategory of "WashUp".
PlateWash	Cleanup	Production	Washing of the plate; subcategory of "WashUp".
Processing New in JDF 1.4	InProgress	Production	Other productive processing (RIP, etc.) is taking place but no final output is being produced. All input data has arrived (not "JobStreaming"/"InProgress" nor "JobIncoming"/"Waiting").
SleeveChange	Stopped	Stopped	Changing of sleeves; subcategory of "Maintenance".
WaitingForMarker New in JDF 1.4	Suspended or Ready	Production	The @Status is "Suspended" if the printing device models any module prior to the marker module, otherwise, the @Status is "Ready". Processing is automatically suspended by the worker because it is waiting behind other jobs for the marker module and the worker will resume processing when a marker module becomes available.
WaitingForReferencedDataCollector New in JDF 1.4	Suspended or Ready	Production	The @Status is "Suspended" if the printing device models any module prior to the referenced data collector module, otherwise, the @Status is "Ready". Processing is automatically suspended by the worker because it is waiting behind other jobs for the referenced data collector module and the worker will resume processing when a referenced data collector module becomes available.
WaitingForRIP New in JDF 1.4	Suspended or Ready	Production	The @Status is "Suspended" if the printing device models any module prior to the RIP module, otherwise, the @Status is "Ready". Processing is automatically suspended by the worker because it is waiting behind other jobs for a RIP module (process slot) and the worker will resume processing when a RIP module becomes available.
WashUp	Cleanup	Production	Machine is washed before, during or after production. "WashUp" has specialized subcategories: "BlanketWash", "CleaningInkFountain", "CylinderWash", "DampeningRollerWash", "InkRollerWash", or "PlateWash". "WashUp" is the default that is assumed if @StatusDetails is not specified.

A.4.22.3 Status Details for Postpress Devices

Table A.100: Status Details Mapping for Postpress Devices (Sheet 1 of 2)

STATUS DETAILS	JDF/ @STATUS	DEVICESTAT US	DESCRIPTION
BadFeed New in JDF 1.2	Stopped	Stopped	Bad feed on a feeder; subcategory of "Failure".
BadTrim New in JDF 1.2	Stopped	Stopped	Bad trimmed components; subcategory of "Failure".
DoubleFeed New in JDF 1.2	Stopped	Stopped	Double feeds on a feeder; subcategory of "Failure".
IncorrectComponent New in JDF 1.2	Stopped	Stopped	Incorrect components on a feeder; subcategory of "Failure".

Table A.100: Status Details Mapping for Postpress Devices (Sheet 2 of 2)

STATUS DETAILS	JDF/ @STATUS	DEVICESTAT US	DESCRIPTION
IncorrectThickness New in JDF 1.2	Stopped	Stopped	Incorrect thickness of components; subcategory of "Failure".
ObliqueSheet New in JDF 1.2	Stopped	Stopped	Oblique sheets on components; subcategory of "Failure". Oblique sheets are sheets or signatures that are not properly aligned within a pile (e.g., on a gathering or collecting chain).

A.4.23 Texture

The following table defines a list of values that are valid for indicating the intended texture of the item to be used. This is typically the media or substrate.

Note: Values of the form IPP:xxx are provided for mapping to PWG Print Job Ticket. See ▶ [PWGMAP].

Table A.101: Texture

VALUE	DESCRIPTION
Antique	Rougher than vellum surface.
Calendared	Extra smooth or polished, uncoated paper.
Glossy New in JDF 1.6	Glossy media.
IPP:Course New in JDF 1.6	Generic value for coarse finish.
IPP:Fine New in JDF 1.6	Generic value for fine finish.
IPP:Medium New in JDF 1.6	Generic value for finish that is neither IPP:Fine nor IPP:Course.
Linen	Texture of coarse woven cloth.
Matte New in JDF 1.6	Matte media.
Smooth	Generic term for smooth paper.
Stipple	Fine pebble finish.
Vellum	Slightly rough surface.

A.4.24 Units

The following defines a list of values that are valid for indicating the unit of a measurement quantity.

Note: The values in the following table are ordered alphabetically by measurement type.

Table A.102: Units (Sheet 1 of 2)

VALUE	MEASUREMENT	UNIT	DESCRIPTION
degree	Angle	degree°	An angle in degrees.
m2	Area	m ²	Used for media (e.g., in wide format printing).
count	Countable Objects Modified in JDF 1.4	1	Countable objects, such as sheets, MAY be specified as "count".
pt	Length	point (1/72 inch)	Used for all except microscopic lengths (see below).

Table A.102: Units (Sheet 2 of 2)

VALUE	MEASUREMENT	UNIT	DESCRIPTION
um	Length	micron (μ)	Used for microscopic lengths — where used (instead of points) it will be explicitly stated in the definition of the item. See Media/@Thickness .
lpi	Line Screen	lpi	The lines per inch (lpi) for conventionally screened halftone, screened gray scale and screened monotone bitmap images.
gsm	Paper weight	g/m^2	Paper weight SHALL be provided in grams per square meter. See ▶ Appendix E Media Weight for details of calculating paper weights that are not in g/m^2 .
kWh	Power (electrical) New in JDF 1.6	kilowatt hour	Used to measure consumption of electricity. Note: Current power consumption (kW) MAY be provided in a ResourceInfo as ‘rate of consumption’ of electric power, i.e. kWh/h=kW.
dpi	Resolution	dpi	The dots per inch (dpi) for print output and bitmap image (TIFF, BMP, etc.) file resolution.
ppi	Screen Resolution	ppi	The pixels per inch (ppi) for screen display (e.g., soft proof display and user interface display), scanner capture settings and digital camera settings.
spi	Spot Resolution	spi	For imaging devices such as filmsetters, platesetters and proofers, the fundamental imaging unit (e.g., one “on” laser or imaging head imaged unit). Note: Many imaging devices construct dots from multiple imaging spots, so dpi and spots per inch (spi) are not necessarily equivalent.
C	Temperature	°C (Celsius)	The temperature in degrees centigrade.
m3	Volume (gas) New in JDF 1.6	m^3 (cubic meter)	Used to measure consumption of gas.
l	Volume (liquid)	liter	The volume in liters.
g	Weight	gram	The weight in grams.

A.5 JDF File Formats

This section describes the specific file formats used by **JDF**. **JDF** uses TIFF and JPEG file formats, as well as the PNG image file format. The following sections explain in what ways PNG is used in **JDF**.

A.5.1 PNG Image Format

JDF uses the PNG images for representing preview images. CIP3 defined two formats: composite CMYK and separated. With PNG, only the separated format is supported for color spaces other than RGB. The composite CMYK or spot color representations SHALL be represented as separated CMYK or spot colors. Thus, preview images are stored as separate PNG images, and **JDF** links them together. Viewable images and thumbnails can be represented as composite RGB PNG images. See ▶ [ISO/IEC 15948:2004].

B Schema

XML schema for **JDF** (and **JMF**) will be published at: <http://www.CIP4.org>.

The XML schema is not sufficient to completely validate a **JDF** job. For example, partitioned resources or process node types as defined in **JDF** cannot be validated by XML schema processors. In other words, the structure of some elements depends on the context of usage which cannot be completely described by XML schema. Thus, the XML schema for **JDF** will be structured in a way that enables a pre-validation of valid **JDF**-candidates but does not preclude all syntactically invalid files to be validated.

B.1 Using `xsi:type`

New in JDF 1.2

XML schema permits that multiple type definitions be derived from a base type. Wherever the schema has define an element of that base type, it is possible for the document to indicate to a validator the particular derived type that it has used. It does this by using the `@xsi:type` attribute with a value of the name of the type, where the "xsi" tag is associated with the schema instance namespace that has to be declared in the document.

Note: Use of "xsi" as the tag is normal practice.

Note: The selected type is namespace qualified (which permits extensions)

B.1.1 Using `xsi:type` with JDF Nodes

New in JDF 1.2

If used with **JDF** nodes, then all processes defined in ▶ Chapter 6 Processes are supported. Furthermore the value to be used is identical to the process type, thus a **JDF** node that has a `@Type` of "DigitalPrinting" can inform validators to use the schema definition for **DigitalPrinting** nodes by also setting `@xsi:type` to "DigitalPrinting".

Some **JDF** nodes are general in their nature and do not have a restricted definition (i.e., product intent nodes, combined process nodes and so on). General definitions with the appropriate name are provided to enable consistent use of `@xsi:type`.

The **JDF** schema defines types for **JDF** process nodes and **JMF** messages. It is RECOMMENDED that these types are used with `@xsi:type`.



Using JDF Schema

Any JDF processor SHOULD be capable of validating whether or not a JDF job meets JDF requirements. This can be accomplished by using a schema when parsing or by using an application derived from a schema. The schema itself MAY be subsetted into multiple schemas that are used for validation purposes at different points in the workflow. For instance, a JMF schema subset MAY be used to test JDF-compliant devices on your shop floor. A product intent subset may be used to check customer submitted job specifications.

Example B.1: JDF Nodes: xsi:type

```
<JDF xmlns="http://www.CIP4.org/JDFSchema_1_1" ID="BackCover"
  Status="InProgress" Type="DigitalPrinting" Version="1.6" JobPartID="345"
  xmlns:xsi="http://www.w3.org/2001/XMLSchema-instance"
  xsi:schemaLocation="http://www.CIP4.org/Schema/JDFSchema_1_1 http://www.CIP4.org/Schema/JDF/
JDF1_6"
  xsi:type="DigitalPrinting">
  <ResourceLinkPool>
    <DigitalPrintingParamsLink Usage="Input" rRef="ID123"/>
    <RunListLink Usage="Input" rRef="ID124"/>
    <ComponentLink Usage="Output" rRef="ID125"/>
  </ResourceLinkPool>
  <ResourcePool>
    <DigitalPrintingParams ID="ID123" Class="Parameter" Status="Available"/>
    <RunList ID="ID124" Class="Parameter" Status="Available"/>
    <Component ID="ID125" Class="Quantity" Status="Unavailable" ComponentType="Sheet"/>
  </ResourcePool>
</JDF>
```

Example B.2: JDF Nodes: xsi:type (not in Default Namespace)

If the **JDF** is not in the default namespace then the type name needs to be altered accordingly:

```
<jdf:JDF ID="BackCover" JobPartID="345" Status="InProgress"
  Type="DigitalPrinting" Version="1.6"
  xmlns:jdf="http://www.CIP4.org/JDFSchema_1_1"
  xmlns:xsi="http://www.w3.org/2001/XMLSchema-instance" xsi:type="jdf:DigitalPrinting">
<jdf:ResourceLinkPool>
  <jdf:DigitalPrintingParamsLink Usage="Input" rRef="ID123"/>
  <jdf:RunListLink Usage="Input" rRef="ID124"/>
  <jdf:ComponentLink Usage="Output" rRef="ID125"/>
</jdf:ResourceLinkPool>
<jdf:ResourcePool>
  <jdf:DigitalPrintingParams Class="Parameter" ID="ID123" Status="Available"/>
  <jdf:RunList Class="Parameter" ID="ID124" Status="Available"/>
  <jdf:Component Class="Quantity" ComponentType="Sheet" ID="ID125" Status="Unavailable"/>
</jdf:ResourcePool>
</jdf:JDF>
```

B.1.2 Using xsi:type with JMF Messages

New in JDF 1.2

JMF messages are organized into families — **Command**, **Query**, etc. (See ▶ Section 5.2 JMF Message Families) — and each of these families has messages for each message **@Type** — **Events**, etc.

Every JMF message is a unique combination of ‘message family’ and ‘message type’, and the JDF schema contains a definition for each of them. To inform a validating parser which message definition to use, the **@xsi:type** attribute has to have a unique name; CIP4 chose to use a convolution of the ‘message family’, e.g. ‘Command’ and the ‘message type’, e.g. ‘Event’.

For example, to query an event, a query message with an **Events** as the query object would be used. The type definition name required by the JDF schema for this message would therefore be **QueryEvents**.

Note: JMF messages are not required to use the default namespace as is used in the **JDF** example below.

Example B.3: JMF: xsi:type

```
<JMF MaxVersion="1.6" SenderID="TestSender"
  TimeStamp="2003-11-07T12:15:56Z" Version="1.6"
  xmlns="http://www.CIP4.org/JDFSchema_1_1" xmlns:xsi="http://www.w3.org/2001/XMLSchema-in-
stance">
  <Query ID="Message_001Q" Type="Events" xsi:type="QueryEvents">
    <NotificationFilter/>
  </Query>
  <Response ID="Message_001R" Type="Events" refID="Q001" xsi:type="ResponseEvents">
    <NotificationDef Classes="Error" Type="Barcode"/>
  </Response>
</JMF>
```

Appendix C

C Return Values

The following list defines the standard return code for messaging. Return code values are integers. Error values below 100 are reserved for protocol errors. Error values above 100 are used for device and controller errors, while those higher than 200 refer to job and pipe specific errors. Error Codes above 300 are used for errors related to authentication and certificate exchange.

Table C.1: Return codes for JMF (Sheet 1 of 3)

RETURNCODE	DESCRIPTION
0	Success.
1 – 99	Protocol errors.
1	General error.
2	Internal error.
3	XML parser error (e.g., if a MIME file is sent to an XML controller).
4	XML validation error.
5	Query message/Command Message not implemented.
6	Invalid parameters.
7	Insufficient parameters.
8	Device not available (controller exists but not the device or queue).
9	Message incomplete.
10 New in JDF 1.3	Message service is busy.
11 New in JDF 1.4	Synchronous mode not supported for message. No <code>@AcknowledgeURL</code> is specified and the message can only be processed asynchronously and was not processed. (Error).
12 New in JDF 1.4	Asynchronous acknowledge not supported for message. No <code>@AcknowledgeURL</code> is specified and the message was processed. The resulting <code>Acknowledge</code> can only be emitted asynchronously. (Warning).
13 New in JDF 1.4	Reliable signals not supported. Subscription denied.
100 – 199	Device and controller errors.
100	Device not running.
101	Device incapable of fulfilling request (e.g., a RIP that has been asked to cut a sheet).
102	No executable node exists in the JDF .
103	<code>@JobID</code> not known by controller.
104	<code>@JobPartID</code> not known by controller.
105	Queue entry not in queue.
106	Queue request failed because the queue entry is already executing.
107	The queue entry is already executing. Subsequent changes are not accepted.

Table C.1: Return codes for JMF (Sheet 2 of 3)

RETURNCODE	DESCRIPTION
108	Selection or applied filter results in an empty list.
109	Selection or applied filter results in an incomplete list. A buffer cannot provide the complete list queried for.
110	Queue request of a job submission failed because the requested completion time of the job cannot be fulfilled.
111	Subscription request denied.
112 New in JDF 1.1	Queue request failed because the queue is closed or blocked and did not accept new entries.
113 New in JDF 1.2	Queue entry is already in the resulting status.
114 Modified in JDF 1.4	QueueEntry/@Status is already "PendingReturn", "Completed" or "Aborted" and therefore does not accept changes. Modification note: Starting with JDF 1.4, "PendingReturn" added.
115 New in JDF 1.2	Queue entry is not running.
116 New in JDF 1.3	Queue entry already exists. Used when a QueueEntry with identical @JobID , @JobPartID and Part already exists.
120 New in JDF 1.3	Cannot access referenced URL or URI reference cannot be resolved. Used when a referenced entity, e.g. a JDF in a SubmitQueueEntry , cannot be found.
121 New in JDF 1.3	Unknown @DeviceID . No device is known with the @DeviceID specified.
130 New in JDF 1.3	Ganging is not supported. A gang job has been submitted to a queue that does not support ganging.
131 New in JDF 1.3	GangName not known. A job has been submitted with an unknown GangName .
200 – ...	Job and pipe specific errors.
200	Invalid resources.
201	Insufficient resource parameters.
202	PipeID unknown.
203	Unlinked ResourceLink .
204 New in JDF 1.3	Could not create new JDF node.
205 New in JDF 1.6	Pipe request failed because the pipe is closed and does not accept new requests.
300 New in JDF 1.3	Authentication denied.
301 New in JDF 1.3	Secure channel not supported – I don't support secure channel for this message.
302 New in JDF 1.3	Secure channel required – I require secure channel for this message.
303 New in JDF 1.3	Certificate expired (Some implementations might not be able to send this response because the SSL layer will reject the message before passing it to the JMF implementation for parsing).

Table C.1: Return codes for JMF (Sheet 3 of 3)

RETURNCODE	DESCRIPTION
304 New in JDF 1.4	Authentication pending.
305 New in JDF 1.4	Authentication already established.
306 New in JDF 1.4	No authentication request in process.
307 New in JDF 1.4	Certificate invalid.

D Color Adjustment

New in JDF 1.2

This appendix describes several alternative usages for some of the **ColorCorrectionOp** attributes in the element, see ▶ Section 8.22 **ColorCorrectionParams**. These are intended to allow simple, late-in-the-workflow, minor adjustments to the overall color appearance of a job or portions of a job.

Note: These color adjustments are not available in any intent resource, such as **ColorIntent**. In order to request such adjustment in a product intent job ticket supplied to a print provider, attach to a product intent node an incomplete **ColorCorrection** process with a **ColorCorrectionParams** resource specifying the requested **ColorCorrectionOp** element attributes.

D.1 Adjustment Using Direct Attributes

This section describes the attributes that permit direct adjustments to various aspects of the color space:

Table D.1: Attributes for Color Space Adjustment

ATTRIBUTE NAME	ALLOWED VALUE RANGE
<i>AdjustCyanRed</i>	-100 to +100
<i>AdjustMagentaGreen</i>	-100 to +100
<i>AdjustYellowBlue</i>	-100 to +100
<i>AdjustContrast</i>	-100 to +100
<i>AdjustHue</i>	-180 to +180
<i>AdjustLightness</i>	-100 to +100
<i>AdjustSaturation</i>	-100 to +100

These attributes can be applied at a point where an abstract profile would be applied (following any abstract profiles used) in the order: *@AdjustLightness*, *@AdjustContrast*, *@AdjustSaturation*, *@AdjustHue*, {*@AdjustCyanRed*/*@AdjustMagentaGreen*/*@AdjustYellowBlue*}. The operation of each adjustment attribute is described in relation to colors expressed in the L*a*b* connection color space (with L* expressed on a scale of 0 to 100).

Note: In the C-language-like assignment statements below, the variables L, a and b are used to represent values of the L*, a* and b* channels to avoid ambiguity with the “*” used to denote multiplication in these statements.

- *@AdjustLightness* offsets the L* channel. [L += *@AdjustLightness*]
- *@AdjustContrast* scales the L* channel about mid-scale (where L = 50).
[L = 50 + (L - 50) * (*@AdjustContrast* / 100 + 1)]
- *@AdjustSaturation* scales the a* and b* channels about zero. [a *= (*@AdjustSaturation* / 100 + 1)] and [b *= (*@AdjustSaturation* / 100 + 1)]

@AdjustCyanRed, *@AdjustMagentaGreen* and *@AdjustYellowBlue* offset the colors in the a*b* plane along the respective color vector. Lightness (L*) is not changed. Positive values offset towards red, green or blue, and negative values offset towards cyan, magenta or yellow. The adjustment vectors are aligned with the standard SWOP inks. When adjusting device colors, these adjustments can be approximated by offsets along the vectors of the actual ink colors being used. The angles and unit vectors for SWOP inks (from the CGATS TRO01 print characterization) are:

	Red-cyan	Green-Magenta	Blue-yellow
Angle	-129.9	-5.3	94.5
a*	0.641	-0.996	0.078
b*	0.767	0.092	-0.997

So

$$\begin{aligned}
a^* & += 0.641 * @AdjustCyanRed \\
& \quad - 0.996 * @AdjustMagentaGreen \\
& \quad + 0.078 * @AdjustYellowBlue \\
\\
b^* & += 0.767 * @AdjustCyanRed \\
& \quad + 0.092 * @AdjustMagentaGreen \\
& \quad - 0.997 * @AdjustYellowBlue
\end{aligned}$$

@AdjustHue offsets the hue angle value when the colors have been transformed to the CIE- L* C* H* (luminance, chroma and hue) color space from the L*a*b* connection color space. The *@AdjustHue* angle is expressed in degrees.

Note: In the C-language-like assignment statements below, the variables L, a and b are used to represent values of the L*, a* and b* channels to avoid ambiguity with the "*" used to denote multiplication in these statements.

- $a = a * \cos(@AdjustHue) - b * \sin(@AdjustHue)$
- $b = a * \sin(@AdjustHue) + b * \cos(@AdjustHue)$

D.2 Adjustment using ICC Profile Attributes

This section describes two alternatives to the direct color adjustment attributes providing adjustments of the same nature using ICC profiles. The ICC profile approach provides a standard mechanism for applying a set of multi-dimensional adjustments with a single operation. The ICC profile approach is also advantageous in that it minimizes algorithm and interpretation dependency on the receiving end.

D.3 Adjustment using an ICC Abstract Profile Attribute

A color adjust can be encapsulated in an ICC abstract profile that is applied in ICC Profile Connection Space (PCS). The *FileSpec* element of the *ColorCorrectionOpColorCorrectionOp* element with the *@ResourceUsage* attribute set to "AbstractProfile" references an ICC profile to be used in this manner.

D.4 Adjustment using an ICC DeviceLink Profile Attribute

A color adjust can be encapsulated in an ICC DeviceLink profile that is applied in device space. The *FileSpec* element of the *ColorCorrectionOp* element with the *@ResourceUsage* attribute set to "DeviceLinkProfile" references an ICC profile to be used in this manner.

Appendix E

E Media Weight

In North America and Japan, each grade of paper has one basic size used to compute its basis weight per ream. For example, Bond basic size is 17" x 22" and Shiroku-ban basic size is 788 mm x 1091 mm.

E.1 North American Media Weight

New in JDF 1.2

In North America, a paper's basis weight is the weight of five hundred sheets of its basic size. For example, if five hundred 25" x 38" sheets of offset paper weigh 60 pounds, it is called 60# offset. Paper mills outside of North America use the metric system to designate paper weight. The basis weight of foreign papers is grams per square meter (g/m^2) known as the sheet's grammage. Papers made to metric standards don't convert to basis weights familiar to North Americans. For example, 100 g/m^2 equals a basis weight of 67.5lb. Following is the English/grammage conversion formula:

Basis Weight (lb.) x (1406.5 / Square inches in basic size) = grams per square meter

For example, the grammage of 65 lb. cover stock when the cover is 20 x 26 can be calculated as follows:

$$65 \times (1406.5 / (20 \times 26)) = 65 \times 2.70 = 176 \text{ g/m}^2$$

The following table defines the basic sizes and the factor that the North American weight is multiplied by to calculate @Weight for various stock types. Stock type is specified in [Media/@StockType](#) or [MediaIntent/@StockType](#).

Table E.1: Conversion Factor from Basis Weight (lbs) to Weight (g/m^2)

STOCK TYPE	BASIS SIZE IN INCHES	CONVERSION FACTOR	EQUIVALENT
Bond	17 x 22	3.76	"Ledger" New in JDF 1.4, "Manifold" New in JDF 1.4
Book New in JDF 1.4	25 x 38	1.48	"Bible" New in JDF 1.4, "Coated" New in JDF 1.4, "Offset", "Text"
Bristol	22½ x 28½	2.19	
Cover	20 x 26	2.70	
Index	25½ x 30½	1.81	
Newsprint	24 x 36	1.63	"Tag"

In the following table, the right columns of each column pair list common basis weights for North American papers, while the left columns list their corresponding grammage. The rows are ordered by grammage. Basis weights for bond, book, cover and other grades of papers are computed using different basic sizes, so the progression of weights down the right columns is untidy.

Table E.2: Grammage Equivalents for Common (US) Basis Weights (Sheet 1 of 2)

GRAMMAGE (G/M^2)	BASIS WEIGHT	GRAMMAGE (G/M^2)	BASIS WEIGHT
30	20# Book	150	40# Ledger
34	9# Manifold	152	60# Cover
36	24# Book	163	90 # Index
44	30# Book	163	100 # Tag
45	12# Manifold	175	80# Bristol
49	13# Bond	176	65# Cover
49	33# Book	178	120# Book

Table E.2: Grammage Equivalents for Common (US) Basis Weights (Sheet 2 of 2)

GRAMMAGE (G/M ²)	BASIS WEIGHT	GRAMMAGE (G/M ²)	BASIS WEIGHT
52	35# Book	197	90# Bristol
59	40# Book	199	110# Index
60	16# Bond	204	125# Tag
67	45# Bond	216	80# Cover
74	50# Book	219	100# Bristol
75	20# Bond	244	150# Tag
81	55# Book	253	140# Index
89	60# Book	263	120# Bristol
90	24# Bond	270	100# Cover
104	70# Book	285	175# Tag
105	28# Ledger	307	140# Bristol
108	40# Cover	307	170# Index
118	80# Book	325	200# Tag
120	32# Ledger	350	160# Bristol
133	90# Book	352	130# Cover
135	36# Ledger	394	180# Bristol
135	50# Cover	398	220# Index
147	67# Bristol	407	250# Tag
148	100# Book	438	200# Bristol
		488	300# Tag

E.2 Japanese Media Weight

New in JDF 1.3

In Japan, a paper's basis weight is the weight of 1000 sheets of its basic size and ream weights are given in kg.

The following table was originally published by EDS Inc., Editorial & Design Services; see ▶ [Japanese Paper Sizes]. For more help with grammage and basis weight conversion, see also ▶ [Grammage Conversion].

Following is the Japanese/grammage conversion formula:

$$\text{Basis Weight (kg)} / \text{Basic Size (m}^2\text{)} = \text{grams per square meter}$$

For example, the grammage of 70 kg Shiroku-ban stock when the size is 0.788 x 1.091 can be calculated as follows:

$$70 / (0.788 \times 1.091) = 81.4 \text{ g/m}^2$$

In the table below, trade-sheet size is given in mm.

Table E.3: Japanese Media Weight (Sheet 1 of 2)

STOCK TYPE	SHIROKU-BAN 788 X 1091	JIS B-BAN 765 X 1085	KIKU-BAN 636 X 939	JIS A-BAN 625 X 880	GRAMMAGE (G/M ²)
Aatoposutoshi アートポスト紙	180	-	125	-	209.3
	200	-	139	-	232.6
	220	-	153	-	255.0

Table E.3: Japanese Media Weight (Sheet 2 of 2)

STOCK TYPE	SHIROKU-BAN 788 X 1091	JIS B-BAN 765 X 1085	KIKU-BAN 636 X 939	JIS A-BAN 625 X 880	GRAMMAGE (G/M ²)
Aatoshi アート紙	73	70.5	50.5	46.5	84.9
	90	87	62.5	57.5	104.7
	110	106	76.5	70.5	127.9
	135	130.5	93.5	86.5	157.0
Chuushitsushi 中質紙	-	45	-	30	54.2
	-	55	-	36.5	66.3
Joushitsu 上質紙	40	-	-	-	46.5
	45	-	31	20.5	52.3
	55	53	38	35	64.0
	70	67.5	48.5	44.5	81.4
	90	-	62.5	47.5	104.7
	110	-	71.5	70.5	127.9
	135	-	93.5	80.5	157.0
	180	-	-	-	209.3
Mashinkootoshi マシンコート紙	63	61	-	-	73.3
	68	65.6	47	43.5	79.1
	73	70.5	50.5	46.5	84.9
	90	87	62.5	57.5	104.7
	110	106	76.5	70.5	127.9
	135	130.5	93.5	86.5	157.0

The following describes the five stock types in the above table:

- 上質紙 Joushitsu (“top-quality paper”) contains 100% chemical pulp
- 中質紙 Chuushitsu (“medium-quality paper”) contains a minimum of 70% chemical pulp
- アート紙 Aatoshi (“art paper”) is machine coated paper, available in top quality and medium quality (Joushitsu and Chuushitsu)
- マシンコート紙 Mashinkootoshi (“machine coated paper”), also called Kootoshi (コート紙), is machine coated paper given only a thin coat of clay
- アートポスト紙 Aatoposutoshi (“art-post paper”) is cover stock coated on one side

E.3 Paper Grade

▶ [ISO12647-2:2004] provides a rough classification of paper with 5 classes, which is generally referred to as paper grade. ▶ [ISO12647-2:2013] was updated in 2013, and a new set of 8 standard papers was defined that are more appropriate for paper types that are used today. The following table provides a rough and non-normative translation between the two standard sets:

Table E.4: Translation of Paper grades between [ISO12647-2:2004] and [ISO12647-2:2013]

ISO12647-2:2013		PRESS	ISO12647-2:2004	
ID	TYPE		GRADE	TYPE
PS1	Premium Coated	Sheet	1	Gloss coated

Table E.4: Translation of Paper grades between [ISO12647-2:2004] and [ISO12647-2:2013]

ISO12647-2:2013		PRESS	ISO12647-2:2004	
ID	TYPE		GRADE	TYPE
PS2	Improved Coated	Web	3	Gloss coated, web
PS3	Standard Coated Glossy	Web	3	Gloss coated, web
PS4	Standard Coated Matte	Web	2	Matte coated
PS5	Wood free Uncoated	Sheet	4	Uncoated white
PS6	Super Calendered	Web	4	Uncoated white
PS7	Improved Uncoated	Web	4	Uncoated white
PS8	Standard Uncoated	Web	4/5	Uncoated white/yellowish

Appendix F

F Media Size

The following table defines a set of named media sizes as defined by ▶ [PPD].

Implementation Remark

Modified in JDF 1.5

Since media sizes may be real numbers, comparison of media sizes SHOULD take into account certain rounding errors. For example, different media sizes SHOULD be considered equal when all numbers are the same within a range of 5 points.

Modification note: Starting with JDF 1.5, the recommended range has been changed from 1 point to 5 points.

F.1 Architectural Paper Sizes

Table F.1: Architectural Paper Sizes

MEDIA SIZE	SIZE IN POINTS	SIZE IN MILLIMETERS	SIZE IN INCHES
ArchA	648 x 864	228.6 x 304.8	9 x 12
ArchB	864 x 1296	304.8 x 457.2	12 x 18
ArchC	1296 x 1728	457.2 x 609.6	18 x 24
ArchD	1728 x 2592	609.6 x 914.4	24 x 36
ArchE	2592 x 3456	914.4 x 1219.2	36 x 48
ArchE1	2160 x 3024	762.0 x 1066.8	30 x 42
ArchE2	1872 x 2736	660.4 x 965.2	26 x 38
ArchE3	1944 x 2808	685.8 x 990.6	27 x 39

F.2 Business Card Sizes

Table F.2: Business Card Sizes

MEDIA SIZE	SIZE IN POINTS	SIZE IN MILLIMETERS	SIZE IN INCHES
BusinessCard_Japan	156 x 258	55 x 91	2.2 x 3.6
BusinessCard_UK	156 x 241	55 x 85	2.2 x 3.3
BusinessCard_US	145 x 252	51 x 89	2.0 x 3.5

F.3 International A Paper Sizes

These sizes are defined by ISO standards, including ▶ [ISO216:2007] and by JIS standards ▶ [JIS P0138] except where noted.

Table F.3: International A Paper Sizes (Sheet 1 of 2)

MEDIA SIZE	SIZE IN POINTS	SIZE IN MILLIMETERS	SIZE IN INCHES
A0	2384 x 3370	841 x 1189	33.11 x 46.81
A1	1684 x 2384	594 x 841	23.39 x 33.11

Table F.3: International A Paper Sizes (Sheet 2 of 2)

MEDIA SIZE	SIZE IN POINTS	SIZE IN MILLIMETERS	SIZE IN INCHES
A2	1191 x 1684	420 x 594	16.54 x 23.39
A3	842 x 1191	297 x 420	11.69 x 16.54
A3Extra ^a	913 x 1262	322 x 445	12.67 x 17.52
A4	595 x 842	210 x 297	8.27 x 11.69
A4Extra ^a	667 x 914	235 x 322	9.27 x 12.69
A4Plus ^a	595 x 936	210 x 330	8.27 x 13.00
A4Tab ^a	638 x 842	225 x 297	8.86 x 11.69
A5	420 x 595	148 x 210	5.83 x 8.27
A5Extra ^a	492 x 668	174 x 235	6.85 x 9.25
A6	297 x 420	105 x 148	4.13 x 5.83
A7	210 x 297	74 x 105	2.91 x 4.13
A8	148 x 210	52 x 74	2.05 x 2.91
A9	105 x 148	37 x 52	1.46 x 2.05
A10	73 x 105	26 x 37	1.02 x 1.46

a. Non-standard ISO size variations.

F.4 International B Paper Sizes

These sizes are defined by ISO standards, including ▶ [ISO216:2007] and by JIS standards ▶ [JIS P0138].

Table F.4: International B Paper Sizes

MEDIA SIZE	SIZE IN POINTS	SIZE IN MILLIMETERS	SIZE IN INCHES
B0	2920 x 4127	1030 x 1456	40.55 x 57.32
B1	2064 x 2920	728 x 1030	28.66 x 40.55
B2	1460 x 2064	515 x 728	20.28 x 28.66
B3	1032 x 1460	364 x 515	14.33 x 20.28
B4	729 x 1032	257 x 364	10.12 x 14.33
B5	516 x 729	182 x 257	7.17 x 10.12
B6	363 x 516	128 x 182	5.04 x 7.17
B7	258 x 363	91 x 128	3.58 x 5.04
B8	181 x 258	64 x 91	2.52 x 3.58
B9	127 x 181	45 x 64	1.77 x 2.52
B10	91 x 127	32 x 45	1.26 x 1.77

F.5 International C Envelope Sizes

These sizes are defined by ISO standards, including ▶ [ISO216:2007].

Table F.5: International C Envelope Sizes

MEDIA SIZE	SIZE IN POINTS	SIZE IN MILLIMETERS	SIZE IN INCHES
C0	2599 x 3676	917 x 1297	36.1 x 51.1
C1	1837 x 2599	648 x 917	25.5 x 36.1
C2	1298 x 1837	458 x 648	18.0 x 25.5
C3	918 x 1298	324 x 458	12.8 x 18.0
C4	649 x 918	229 x 324	9.0 x 12.8
C5	459 x 649	162 x 229	6.4 x 9.0
C6	323 x 459	114 x 162	4.5 x 6.4
C7	230 x 323	81 x 114	3.2 x 4.5
C8	162 x 230	57 x 81	2.2 x 3.2
C9	113 x 162	40 x 57	1.6 x 2.2
C10	79 x 113	28 x 40	1.1 x 1.6

F.6 RA and SRA Paper Sizes

Table F.6: RA and SRA Paper Sizes

MEDIA SIZE	SIZE IN POINTS	SIZE IN MILLIMETERS	SIZE IN INCHES
RA0	2438 x 3458	860 x 1220	33.9 x 48.0
RA1	1729 x 2438	610 x 860	24.0 x 33.9
RA2	1219 x 1729	430 x 610	16.9 x 24.0
RA3	865 x 1219	305 x 430	12.0 x 16.9
RA4	609 x 865	215 x 305	8.5 x 12.0
SRA0	2551 x 3628	900 x 1280	35.4 x 50.4
SRA1	1814 x 2551	640 x 900	25.2 x 35.4
SRA2	1276 x 1814	450 x 640	17.7 x 25.2
SRA3	907 x 1276	320 x 450	12.6 x 17.7
SRA4	638 x 907	225 x 320	8.9 x 12.6

F.7 US ANSI Paper Sizes

Table F.7: US ANSI Paper Sizes (Sheet 1 of 2)

MEDIA SIZE	SIZE IN POINTS	SIZE IN MILLIMETERS	SIZE IN INCHES
AnsIA ^a	612 x 792	215.9 x 279.4	8.5 x 11
AnsIB ^b	792 x 1224	279.4 x 431.8	11 x 17

Table F.7: US ANSI Paper Sizes (Sheet 2 of 2)

MEDIA SIZE	SIZE IN POINTS	SIZE IN MILLIMETERS	SIZE IN INCHES
AnsiC	1224 x 1584	431.8 x 558.8	17 x 22
AnsiD	1584 x 2448	558.8 x 863.6	22 x 34
AnsiE	2448 x 3168	863.6 x 1117.6	34 x 44

- a. Equivalent to US Letter.
- b. Equivalent to US Ledger & Tabloid.

F.8 US Paper Sizes

Table F.8: US Paper Sizes

MEDIA SIZE	SIZE IN POINTS	SIZE IN MILLIMETERS	SIZE IN INCHES
HalfLetter	396 x 612	139.7 x 215.9	5.5 x 8.5
Letter ^a	612 x 792	215.9 x 279.4	8.5 x 11
Legal	612 x 1008	215.9 x 355.6	8.5 x 14
JuniorLegal	360 x 576	127.0 x 203.2	5 x 8
LedgerTabloid ^b	792 x 1224	279.4 x 431.8	11 x 17

- a. Equivalent to ANSI A.
- b. Equivalent to ANSI B.

Appendix G

G MimeTypes

New in JDF 1.2

This appendix lists example values for the following Attributes of the [FileSpec](#) Resource: [@MimeType](#) and [@MimeTypeVersion](#). The preferred file name extension is also indicated for use in the [FileSpec/@URL](#) Attribute. The tables below apply to the values of [@PDLType](#) and [@PDLVersion](#) defined in [▶ Section 10.3.2.5 Document Properties](#), respectively. The listing is intended to be exhaustive for the most likely document formats that are routinely used in **JDF** applications. However, other document formats and other combinations of the listed document formats can be used as well. When these format standards are revised with new version numbers, they **MAY** be used and **SHOULD** follow the patterns established in the following tables.

Many [@MimeTypeVersion](#) values are taken from the *Printer MIB* [▶ \[RFC3805\]](#) by using the a language (e.g., PS, PCL, etc.) as a prefix followed by the level or version defined for **prtInterpreterLangLevel** separated by a “/” character (e.g., “PS/3” for PostScript Level 3). For file formats not in the *Printer MIB*, the prefix is the common acronym for the format with “/” changed to “-” so that the prefix always ends with the first “/” (e.g. “DCS/2.0” for DCS version 2.0 and “TIFF-IT/BL/P1:1998” for TIFF/IT — Binary Line art image data — profile 1).

[▶ Table G.1 MimeType Attribute Values \(IANA Registered\)](#) lists the [@MimeType](#) values that are MIME Media Types registered with IANA (as opposed to file types which are not registered with IANA) in alphabetical order, as well as possible [@MimeTypeVersion](#) values. A blank [@MimeTypeVersion](#) table entry indicates that there is no recognized version number for the [@MimeType](#). [▶ Table G.1 MimeType Attribute Values \(IANA Registered\)](#) also lists the associated RECOMMENDED file name extensions commonly used by **JDF** applications.

Note: According to [▶ \[RFC2046\]](#) the initial set of MIME media types start with the substrings: “application/”, “audio/”, “image/”, “message/”, “model/”, “multipart/”, “text/” or “video/”. File Types will not start with these strings. The [@Compression](#) values that do have a corresponding IANA MIME type are also listed, so that a file that is so compressed or encoded has an appropriate [@MimeType](#) value for the file, as shown below.

Modification note: Starting with **JDF 1.4**, the second column “Sample MimeType Version” replaces “MimeType Version” and rows with same value of MimeType, but with different values of MimeType Version are reduced to a single row with just a sample MimeType Version

Table G.1: MimeType Attribute Values (IANA Registered) (Sheet 1 of 3)

MIMETYPE	SAMPLE MIMETYPE - VERSION	FILE EXTENSION	DESCRIPTION [IANA-MT] INDICATES IANA REGISTRATION
application/mac-binhex40	HQX/4.0	.hqx	Macintosh BinHex 4.0 7-bit encoding ▶ [RFC1741] Note: BinHex encoding converts an 8-bit file into a 7-bit format ▶ [RFC1741] , similar to Uuencoding. BinHex format preserves file Attributes, as well as Macintosh resource forks, and includes CRC (Cyclic Redundancy Check) error-checking. This encoding method works on any type of file, including formatted word processing and spreadsheet files, graphics files and even executable files (i.e., programs or applications). Note: BinHex is not to be confused with MacBinary encoding, which is an 8-bit format.
application/msword	MSWORD/XP	.doc	Microsoft Word
application/pdf	PDF/1.6, PDF/X-3:2003	.pdf	Adobe Portable Document Format ▶ [PDF1.6] and Portable Document Format (PDF) PDF/X-3 ▶ [ISO15930-6:2003]
application/postscript	PS/3	.ps	Adobe PostScript™ See ▶ [RFC2045] and ▶ [RFC2046]

Table G.1: MimeType Attribute Values (IANA Registered) (Sheet 2 of 3)

MIMETYPE	SAMPLE MIMETYPE - VERSION	FILE EXTENSION	DESCRIPTION [IANA-MT] INDICATES IANA REGISTRATION
application/vnd.cip4-jdf+xml Modified in JDF 1.5	JDF 1.5	.jdf	CIP4 Job Definition Format (JDF) version 1.5.
application/vnd.cip4-jmf+xml Modified in JDF 1.5	JMF 1.5	.jmf	CIP4 Job Definition Format (JDF) version 1.5 (See Job Messaging Format).
application/vnd.cip4-ptk+xml New in JDF 1.5	PrintTalk 1.5	.ptk	CIP4 PrintTalk version 1.5
application/vnd.cip3-ppf	PPF/3.0	.ppf	CIP3 Print Production Format (PPF) version 3.0, 1998 ▶ [CIP3 - PPF]
application/vnd.hp-PCL	PCL/X	.pcl	Hewlett Packard Printer Control Language (PCL™)
application/vnd.iccprofile New in JDF 1.4		.icc .icm	International Color Consortium (ICC) File Format for Color Profiles taken from the binary coded decimal Profile Header Profile Version Number field (bytes 8 through 11) ▶ [ICC.1] Creation note: Starting with JDF 1.4 this MimeType replaces “ICC Profile”. See ▶ Table G.2 MimeType and File Type Combinations.
application/vnd.podi-ppml+xml	PPML/2.1	.ppml	Personalized Print Markup Language ▶ [PPML]
application/vnd.Quark.QuarkXPress	XPress/6.0	.qxd .qxt .qwd .qwt .qxl .qxb	QuarkXPress ▶ [Quark]
application/zip		.zip	Zip packaging — The actual compression used for each file in a zip package is stored in the zip package as metadata for each file. Therefore, the <i>FileSpec/@Compression</i> Attribute for the contained file MAY use any <i>@Compression</i> value, including “None”, “Compress”, “Gzip” and “ZLIB”.
image/jpeg		.jpeg .jpg	JPEG See ▶ [RFC2045] and ▶ [RFC2046]. Note: The mime type of image/jpeg is really an image format, not a file format. JFIF and EXIF are file formats that contain image/jpeg image format data, and some applications have their own formats that are similar to JFIF and EXIF but which are proprietary. Nonetheless, the “image/jpeg” <i>@MimeType</i> value is used to identify these file types.
image/tiff	tiff/6.0	.tiff .tif	Tag Image File Format ▶ [RFC3302] Note: The image/tiff MIME <i>@MediaType</i> is assumed to be TIFF Revision 6.0 as defined in detail by Adobe in ▶ [TIFF6]. TIFF/IT is a different MIME type.
multipart/related		.mjd .mjm	Multipart/Related with JDF as the first part ▶ [RFC2387]

Table G.1: MimeType Attribute Values (IANA Registered) (Sheet 3 of 3)

MIMETYPE	SAMPLE MIMETYPE - VERSION	FILE EXTENSION	DESCRIPTION [IANA-MT] INDICATES IANA REGISTRATION
x-world/x-vrml New in JDF 1.4			

▶ Table G.2 MimeType and File Type Combinations lists the @MimeType values that are file types assigned by CIP4 (as opposed to MIME Media Types which are registered with IANA) and possible @MimeTypeVersion values commonly used in JDF applications. A blank @MimeTypeVersion table entry indicates that there is no recognized version number for the @MimeType. ▶ Table G.2 MimeType and File Type Combinations also lists associated RECOMMENDED file name extensions values. A blank file extension column entry indicates that there is no recognized file name extension for the @MimeType. The @Compression values that do not have a corresponding IANA MIME type are also assigned a file type value, so that a file that is so compressed or encoded has an appropriate @MimeType value for the file, as shown in the table below.

Table G.2: MimeType and File Type Combinations (Sheet 1 of 3)

MIMETYPE	FILE EXTENSION	DESCRIPTION [IANA-MT] INDICATES IANA REGISTRATION
Base64	.mme	Base64 — A format for encoding arbitrary binary information for transmission by electronic mail. ▶ [RFC4648]
Compress		Compress — UNIX compression ▶ [RFC1977].
DCS	.eps	Document Color Separation (DCS), version 2.0. ▶ [DCS2.0]
Deflate		Deflate — The file is compressed using zip public domain compression format ▶ [RFC1951].
GZip	.gz	Gzip — GNU zip compression technology ▶ [RFC1952].
ICC Profile Deprecated in JDF 1.4	.icc .icm	International Color Consortium (ICC) File Format for Color Profiles taken from the binary coded decimal Profile Header Profile Version Number field (bytes 8 through 11) ▶ [ICC.1] Deprecation note: Starting with JDF 1.4 this MimeType becomes "application/vnd.iccprofile". See ▶ Table G.1 MimeType Attribute Values (IANA Registered).
MacBinary	.bin	MacBinary — An encoding format that combines the two forks of a Mac file, together with the file information (Name, Creator Application, File Type, etc.) into a single binary data stream that is suitable for storage or transferring through non-Mac systems. ▶ [macbinary]
Tar	.tar	UNIX packaging format.
TIFF/IT	.fp	TIFF/IT ▶ [ISO12639:2004] — Full Page — baseline Note: The file format TIFF/IT SHALL NOT use the "application/tiff" @MimeType. The "image/tiff" @MimeType conforms to baseline TIFF 6.0 ▶ [RFC3302], whereas TIFF/IT does not conform to TIFF 6.0. Consequently, the widely-deployed TIFF 6.0 readers are not able to read TIFF/IT. The ▶ [RFC3302] requires that an RFC be published in order to extend image/tiff with a parameter that would be needed in order to distinguish TIFF/IT from TIFF. There is no plan by the ISO committee that oversees TIFF/IT to register TIFF/IT with either a parameter to image/tiff or as new separate MIME type. Therefore, TIFF/IT will use the @FileType Attribute instead of the @MimeType Attribute.
TIFF/IT	.ct	TIFF/IT ▶ [ISO12639:2004] — Continuous Tone picture data — baseline
TIFF/IT	.lw	TIFF/IT ▶ [ISO12639:2004] — Continuous Line art — baseline
TIFF/IT	.hc	TIFF/IT ▶ [ISO12639:2004] — High-resolution Continuous tone image data — baseline
TIFF/IT	.mp	TIFF/IT ▶ [ISO12639:2004] — monochrome picture image data — baseline
TIFF/IT	.bp	TIFF/IT ▶ [ISO12639:2004] — Binary Picture image data — baseline

Table G.2: MimeType and File Type Combinations (Sheet 2 of 3)

MIMETYPE	FILE EXTENSION	DESCRIPTION [IANA-MT] INDICATES IANA REGISTRATION
TIFF/IT	.bl	TIFF/IT ▶ [ISO12639:2004] — Binary Line art image data — baseline
TIFF/IT	.fp	TIFF/IT ▶ [ISO12639:2004] — Full Page — profile 1
TIFF/IT	.ct	TIFF/IT ▶ [ISO12639:2004] — Continuous Tone picture data — profile 1
TIFF/IT	.lw	TIFF/IT ▶ [ISO12639:2004] — Color Line art data — profile 1
TIFF/IT	.hc	TIFF/IT ▶ [ISO12639:2004] — High-resolution Continuous tone image data — profile 1
TIFF/IT	.mp	TIFF/IT ▶ [ISO12639:2004] — monochrome picture image data — profile 1
TIFF/IT	.bp	TIFF/IT ▶ [ISO12639:2004] — Binary Picture image data — profile 1
TIFF/IT	.bl	TIFF/IT ▶ [ISO12639:2004] — Binary Line art image data — profile 1
TIFF/IT	.fp	TIFF/IT ▶ [ISO12639:2004] — Full Page — baseline Note: This entry and subsequent ones were created in the context of ▶ [ISO12639:2004], whereas preceding entries were created in the context of the 1998 version of ▶ [ISO12639:2004]
TIFF/IT	.ct	TIFF/IT ▶ [ISO12639:2004] — Continuous Tone picture data — baseline
TIFF/IT	.lw	TIFF/IT ▶ [ISO12639:2004] — Color Line art data — baseline
TIFF/IT	.hc	TIFF/IT ▶ [ISO12639:2004] — High-resolution Continuous tone image data — baseline
TIFF/IT	.mp	TIFF/IT ▶ [ISO12639:2004] — monochrome picture image data — baseline
TIFF/IT	.bp	TIFF/IT ▶ [ISO12639:2004] — Binary Picture image data — baseline
TIFF/IT	.bl	TIFF/IT ▶ [ISO12639:2004] — Binary Line art image data — baseline
TIFF/IT	.sd	TIFF/IT ▶ [ISO12639:2004]
TIFF/IT	.fp	TIFF/IT ▶ [ISO12639:2004] — Full Page — profile 1
TIFF/IT	.ct	TIFF/IT ▶ [ISO12639:2004] — Continuous Tone picture data — profile 1
TIFF/IT	.lw	TIFF/IT ▶ [ISO12639:2004] — Color Line art data — profile 1
TIFF/IT	.hc	TIFF/IT ▶ [ISO12639:2004] — High-resolution Continuous tone image data — profile 1
TIFF/IT	.mp	TIFF/IT ▶ [ISO12639:2004] — monochrome picture image data — profile 1
TIFF/IT	.bp	TIFF/IT ▶ [ISO12639:2004] — Binary Picture image data — profile 1
TIFF/IT	.bl	TIFF/IT ▶ [ISO12639:2004] — Binary Line art image data — profile 1. Note: There is no TIFF/IT P1 conformance level of SD in ▶ [ISO12639:2004]
TIFF/IT	.fp	TIFF/IT ▶ [ISO12639:2004] — Full Page — profile 2
TIFF/IT	.ct	TIFF/IT ▶ [ISO12639:2004] — Continuous Tone picture data — profile 2
TIFF/IT	.lw	TIFF/IT ▶ [ISO12639:2004] — Color Line art data — profile 2
TIFF/IT	.hc	TIFF/IT ▶ [ISO12639:2004] — High-resolution Continuous tone image data — profile 2
TIFF/IT	.mp	TIFF/IT ▶ [ISO12639:2004] — monochrome picture image data — profile 2
TIFF/IT	.bp	TIFF/IT ▶ [ISO12639:2004] — Binary Picture image data — profile 2
TIFF/IT	.bl	TIFF/IT ▶ [ISO12639:2004] — Binary Line art image data — profile 2

Table G.2: MimeType and File Type Combinations (Sheet 3 of 3)

MIMETYPE	FILE EXTENSION	DESCRIPTION [IANA-MT] INDICATES IANA REGISTRATION
TIFF/IT	.sd	TIFF/IT ▶ [ISO12639:2004]
Type 1 Font	.pfa .pfb	Type 1 Font ▶ [type1font]
True Type Font	.ttf	True Type Font ▶ [TrueTypeFont]
Open Type Font	.otf	Open Type Font ▶ [ISO/IEC 14496-22:2015]
UUEncoded	.uue	Uuencode — A set of encoding algorithms for converting files into a series of 7-bit ASCII characters that can be transmitted over the Internet. Originally, uuencode stood for Unix-to-Unix encode, but it has since become a universal protocol used to transfer files between different platforms such as Unix, Windows and Macintosh. Uuencoding is especially popular for sending Email attachments. ▶ [uuencode]
ZLIB		ZLIB — ZLIB compression ▶ [RFC1950]

Appendix H

H String Generation

New in JDF 1.3

JDF specifies a set of `@XXXFormat` `@XXXTemplate` pairs that allow dynamic generation of strings.

The function defined when using the attributes `@XXXFormat` and `@XXXTemplate` is based on the standard C `printf()` function. (See ▶ [K&R].) `@XXXFormat` is the first argument and `@XXXTemplate` is a comma-separated list of the additional arguments. `@XXXTemplate` MAY contain unary operators: “+” and “-”, binary operators: “+”, “-”, “*”, “/” and “%”, as well as parentheses: “(” and “)”, which are evaluated using standard C-operator precedence and the variables defined in the following table which include any valid partition key of a partitioned resource.

When evaluating a mathematical expression involving variables, the format evaluation will convert variable values as necessary into the long float values needed to bring about a numeric result, and then convert that result if necessary based on what the format specifier is. For example, if:

- 1 A template contains "`Metadata0 * Metadata1`", and `@Metadata0 = "5"`, and `@Metadata1 = "1.5"`.
- 2 Both partition key values will be converted into long float values before the multiplication is performed
- 3 The result will be 7.5

Then, if the format uses "`%d`", the value will be truncated to 7. If the format uses "`%s`", the string "`7.5`" will be used. Finally, if the format uses "`%f`", the long float value 7.5 will be used.

If a mathematical operation is attempted on a non numeric value, the results are undefined.

Modification note: Starting with **JDF 1.4**, values from `@ShowList` are added to ▶ Table H.1 Predefined variables used in `@XXXTemplate` below and when two values differ only in case, the one starting with an uppercase letter is deprecated.

Table H.1: Predefined variables used in `@XXXTemplate` (Sheet 1 of 4)

NAME	'C' LANGUAGE DATATYPE	DESCRIPTION
<a partition key>	string	Any partition key that is a value of <code>@PartIDKeys</code> in ▶ Table 3.21 Partitionable Resource Element.
<any imposition variable> New in JDF 1.4	any	The value of any variable defined by the Imposition process (see ▶ Section 6.3.18.2 Variables for Automated Imposition).
<code>AcknowledgeType</code>	string	Corresponds to the JMF <code>@AcknowledgeType</code> in the Acknowledge message. See ▶ Section 5.2.5 Acknowledge.
<code>ActualAmount</code> New in JDF 1.6	float	Actual amount of the product that was produced.
<code>all</code> Deprecated in JDF 1.6	string	Selects all matching elements. Valid only when <code>FileSpec</code> is used as an input resource.
<code>Amount</code> New in JDF 1.4	float	Planned amount of the product that was produced.
<code>CustomerID</code>	string	<code>CustomerInfo/@CustomerID</code> .
<code>CustomerName</code> New in JDF 1.6	string	<code>Contact/Person</code> of the customer contact. The sequence and selection of attributes is system dependent.
<code>Date</code>	string	Current date in ▶ [ISO8601:2004] format.
<code>DeviceID</code> New in JDF 1.4	string	<code>Device/@DeviceID</code> of the device that produced the output.
<code>DeviceName</code>	string	<code>Device/@DescriptiveName</code> of the device that produced the output.

Table H.1: Predefined variables used in @XXXTemplate (Sheet 2 of 4)

NAME	'C' LANGUAGE DATATYPE	DESCRIPTION
element Deprecated in JDF 1.6	int	Integer iterator over all elements in a given page. Restarts at 0 for each page.
EndTime New in JDF 1.4	string	Actual end time of the job.
Error New in JDF 1.4	string	List of errors that occurred during the job. The formatting of errors is system dependent.
ErrorStats New in JDF 1.4	string	Statistics on errors that happened during execution. The formatting of error statistics is system dependent.
ExposedMediaName New in JDF 1.4	string	ExposedMedia / @DescriptiveName of the exposed media (e.g., plate or proof that is being imaged).
FriendlyName New in JDF 1.4	string	@FriendlyName of the device.
GeneralID:XXX New in JDF 1.4	string	GeneralID / @IDValue of a GeneralID [@IDUsage = "XXX"]. For example if @Format = "%i" and @Template = "GeneralID:foo" then for: < GeneralID IDUsage ="foo" IDValue ="1"/> the extracted value is 1.
Generated	string	System generated string, for example a file name.
i Deprecated in JDF 1.6	int	Integer iterator over all files produced by this process. 0-based numbering. Deprecation note: Use the appropriate index related partition key.
input	string	Local file name of the input file. A value of "input" SHALL NOT be specified for a FileSpec that describes an input file.
jobID	string	JDF / @JobID of the job.
JobID Deprecated in JDF 1.4	string	@JobID of the node that is executing. Deprecation note: Use "jobID". Before JDF 1.4, "JobID" was only for JobField / @ShowList .
jobName	string	JDF / @DescriptiveName of the node that is being processed.
JobName Deprecated in JDF 1.4	string	" DescriptiveName " of the node that is executing. Deprecation note: Use "jobName". Before JDF 1.4, "JobName" was only for JobField / @ShowList .
jobPartID	string	JDF / @JobPartID of the job.
JobRecipientName New in JDF 1.4 Deprecated in JDF 1.6	string	Name of the recipient of the job. Deprecation note: Use " CustomerName ".
JobSubmitterName New in JDF 1.4 Deprecated in JDF 1.6	string	Name of the submitter of the job.
LayPartCount2in1 New in JDF 1.3	int	Number of partitions at level 2 within partition level 1 (the base) within the Layout resource. When using the RECOMMENDED @SignatureName / @SheetName partition keys, this equates to the number of signatures within the Layout . All other variants of @LayPartCount <n> in <m> MAY be used, where <n> is an integer greater than <m>, and where <n> does not exceed the depth of the partition tree within the Layout .

Table H.1: Predefined variables used in @XXXTemplate (Sheet 3 of 4)

NAME	'C' LANGUAGE DATATYPE	DESCRIPTION
LayPartIndex2in1 New in JDF 1.3	int	Index (1-based) of partition level 2 within partition level 1 (the base) within the Layout resource. When using the RECOMMENDED @SignatureName/@SheetName partition keys, this equates to the signature number within the Layout . All other variants of @LayPartIndex<n>in<m> MAY be used, where <n> is an integer greater than <m>, and where <n> does not exceed the depth of the partition tree within the Layout .
MediaBrand New in JDF 1.4	string	@Brand of the media that is being printed.
MediaType New in JDF 1.4 Deprecated in JDF 1.6	string	" DescriptiveName " of the media that is being printed.
MoonPhase New in JDF 1.4	string	Phase of the moon at the @StartTime of the job.
Operator New in JDF 1.4	string	Employee/Person that describes the operator. The sequence and selection of attributes is system dependent.
OperatorText New in JDF 1.4	string	Text from the operator as defined in Comment[@Name = "OperatorText"] .
page Deprecated in JDF 1.6	int	Integer iterator over the page number of a document. This value is equivalent to value r (below) for the case that each run contains exactly one page. Deprecation note: Use the @PageNumber partition key.
PressProfileName New in JDF 1.4	string	The value of ColorSpaceConversionParams/FitPolicy/@UserFileName of the ColorSpaceConversion process that is used for final output on the press.
PrintQuality New in JDF 1.4	string	The value of InterpretingParams/@PrintQuality .
ProoferProfileName New in JDF 1.4	string	The value of ColorSpaceConversionParams/FitPolicy/@UserFileName of the ColorSpaceConversion process that is used for proofing.
r Deprecated in JDF 1.6	int	Integer iterator over all RunList partitions with a partition key of "Run" in an input RunList . Deprecation note: Use the @Run partition key.
Resolution New in JDF 1.4	int	The value of ObjectResolution/@Resolution .
ResolutionX New in JDF 1.4	int	The first (X) value of ObjectResolution/@Resolution .
ResolutionY New in JDF 1.4	int	The first (Y) value of ObjectResolution/@Resolution .
ri Deprecated in JDF 1.6	int	Integer iterator over all indices in an input "Run" of a RunList . This index is equivalent to looping over a @RunIndex . Deprecation note: Use the @RunIndex partition key.
ScreeningFamily New in JDF 1.4	string	The value of ScreeningParams/ScreenSelector/@ScreeningFamily .
sep Deprecated in JDF 1.4	string	Separation as defined in the separation partition keys of a partitioned resource. Deprecation note: Starting with JDF 1.4, use the "Separation" partition key.

Table H.1: Predefined variables used in @XXXTemplate (Sheet 4 of 4)

NAME	'C' LANGUAGE DATATYPE	DESCRIPTION
SheetNum New in JDF 1.3 Deprecated in JDF 1.6	int	Integer iterator over the sheet number of a document. Deprecation note: Use the "SheetIndex" partition key.
StartTime New in JDF 1.4	string	Actual start time of the job.
surf Deprecated in JDF 1.3	string	Surface string, "Front" or "Back". Deprecation note: Use the "Side" partition key.
SystemRoot Deprecated in JDF 1.6	string	Root of system directory file structure. This token provides an operating system, independent way to refer to the root. Deprecation note: Use standard URL syntax in @FileFormat.
TileX	int	X coordinate of a Tile.
TileY	int	Y coordinate of a Tile.
Time	string	Current time in ▶ [ISO8601:2004] format.
TotalPagesInDoc New in JDF 1.3	int	Value of RunList/@NPage of the current document.
UserText New in JDF 1.4	string	For JobField, "UserText" references user-defined text in JobField/@UserText.
Warning New in JDF 1.4	string	Warnings that happened during the job. Warnings don't lose information in the resulting job, while errors do. The formatting of warnings is system dependent.

Example H.1: @FileTemplate and @FileFormat

With @JobID="j001" and a RunList defining 2024 created files, this example will iterate over all created files and place them into:

```
"file://myserver.mydomain.com/next/j001/0000/m0000.pdf"
```

...

```
"file://myserver.mydomain.com/next/j001/0020/m0023.pdf"
```

```
<RunList Class="Parameter" ID="R1" Status="Available">
  <LayoutElement>
    <FileSpec FileFormat="file://myserver.mydomain.com/next/%s/%4.i/m%4.i.pdf"
      FileTemplate="JobID,i/100,i%100"/>
  </LayoutElement>
</RunList>
```

I Pagination Catalog

This appendix provides a set of diagrams that explain how pages are arranged in groups when preparing to print on the surfaces of large sheets. The diagrams show a wide range of folding patterns to be used before binding. The folding patterns are specified in the **JDF Fold Catalog** (see ▶ Figure A-1: Fold catalog), which describes how to paginate single-sheet bindery signatures

The purpose of this appendix is to provide a reference for all agents involved in the use of imposition techniques in the printing industry.

I.1 How to interpret the diagrams

I.1.1 Legend

This appendix describes the structure and arrangement of bindery signatures into pagination schemes, which divide sheet surfaces into grids of rectangular areas to be filled by pages during the imposition process. These arrangements are the consequence of manipulations made on the sheets by folding, trimming and binding them in order to make booklets ready for assembly.

This appendix uses diagrams to describe the pagination schemes. Each diagram shows a side of an unfolded sheet, illustrating how it is divided into "signature cells". All cells are usually of the same size, allowing the entire sheet to be divided into equal portions, with each portion covering the whole area between surrounding folds. A signature cell is the space that "receives" a single document page and surrounding margins that are part of the gutters.

Each cell shown in the diagram displays how to orient the document page that is to be imposed there, and specifies the index of the page to be imposed. This means that the resulting booklet will have pages that are properly ordered and properly oriented in the product reader view.

Note: In contrast to the usual convention in this specification that all indices are 'zero' based, the page numbering in the diagrams in this appendix are 'one' based for readability.

The diagrams also show the pagination to be used when pages are flowed in reverse order because of different binding options, see ▶ Section I.1.3 Settings that Modify the Pagination Schemes and ▶ Section I.1.4 Using the Settings to Find the Needed Scheme Transformation.

Figure I-1: Legend for interpreting diagrams

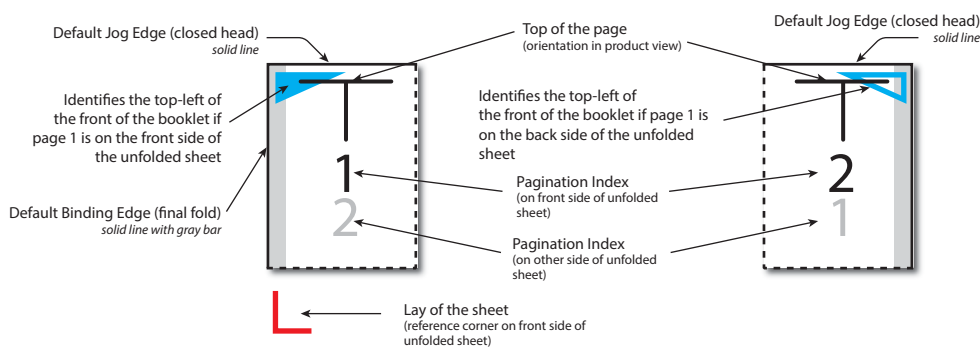

Folding sequences are described using the same notation found in ▶ Section A.4.7 Fold Catalog.

I.1.2 Meaning of a Pagination Scheme

The diagrams in ▶ Section I.2 Pagination Diagrams show the configuration of the page cells that occurs when the bindery signature is specified using [BinderySignature/@FoldCatalog](#).

The pagination indexes shown in the diagram correspond to the imposition order, starting with 1, up to the number of pages in a booklet. This index does not correspond to the actual page numbers that will be imposed on the sheets, unless a finished product is made of a single booklet and the first page is numbered "1". These numbers specify the order that pages are imposed into signature cells, from an array of pages associated with a booklet.

When multiple [BinderySignatures](#) are assembled together, the imposition indexes have to be translated into numbers referring to the list of source document pages. This is calculated using the parameters found in the [Assembly](#) resource and the [StrippingParams/@SectionList](#) parameter.

The numbers and page orientation shown in the diagram correspond to the finished product view in the reader's perspective. The "top of the page", which is a product attribute, does not always correspond to the "head" of the booklet, which is a production attribute. Note, that the finished view is NOT a reference for locating the production measurements (head/foot/face trim and bleed sizes, spine size, overfolds, etc.) as their position is set by the [@BindingOrientation](#) attribute, independently of the final page flow.

1.1.3 Settings that Modify the Pagination Schemes

1.1.3.1 BindingOrientation

When a sheet has been folded, the last fold is recognized as being the "binding edge", and a perpendicular edge is known as the "jog edge". Both edges join together around a corner known as the "reference corner", which appears at the bottom left of the folded sheet (the last fold always appears either at the bottom or at the left when using the fold catalog).

[BinderySignature](#)/[@BindingOrientation](#) MAY be set to indicate that the reference corner SHALL be displaced for production purposes. This modifies the location of the spine, head, face and foot on the booklet before pagination is applied, e.g. for binding calendars or books to allow for a right to left reading order.

This [@BindingOrientation](#) attribute is very special because it has two default values, depending on the type of signature being defined: "Flip0" for single-row grids (no closed head), "Rotate0" for all other grids. This particularity reflects the common practice of recognizing the jog edge to be at the top of signatures without closed heads.

The diagrams in ▶ Section I.2 Pagination Diagrams are based on these default values. If that parameter is set to another value, use the tables in ▶ Section I.1.4 Using the Settings to Find the Needed Scheme Transformation to convert the pagination scheme to reflect this change.

1.1.3.2 Binding and Jog Sides

To facilitate the bindery signatures being assembled together into a finished product, the pages must be imposed in the order and orientation needed to obtain the correct reader's perspective after assembling. Before setting the page numbers and orientation in cells to obtain the expected result, the "assembly" is virtually rotated and flipped to place the binding and jog edges as requested, when looking at the very first page in the reader view.

The diagrams in this appendix show the pagination scheme where the front page of the booklet is oriented so that the binding side appears on the left and the jog side at the top, according to the default parameters defined by this [JDF] specification. For other values, transformations must be applied on the diagrams to get the right scheme.

These settings are found in the Assembly resource that is used to describe how the booklet is assembled:

- [Assembly](#)/[@BindingSide](#)
- [Assembly](#)/[@JogSide](#)

If one or both of these attributes is set, use the tables in ▶ Section I.1.4 Using the Settings to Find the Needed Scheme Transformation to convert the pagination scheme to reflect this change.

The settings [BinderySignature](#)/[@BindingEdge](#) and [BinderySignature](#)/[@JogEdge](#) are ignored because they only affect the production view. However, if [Assembly](#)/[@Order](#)="None", then [BinderySignature](#)/[@BindingEdge](#) and [BinderySignature](#)/[@JogEdge](#) must be used as replacement settings, because assembly parameters must be ignored in that case, and production view becomes the product view.

1.1.4 Using the Settings to Find the Needed Scheme Transformation

Use the table below to locate the name of the scheme transformation to be applied on the diagram, according to the [@BindingSide](#), [@JogSide](#) and [@BindingOrientation](#) settings. Default values for these settings are underlined in the table.

The obtained transformation is identified by a "scheme name", which refers to ▶ Table I.2 Transformations for each Scheme, where all pagination schemes are explained, based on the diagrams in ▶ Table I.7 Pagination Diagrams.

Table I.1: Scheme Names for Binding Orientations

@BindingSide	@JogSide	SCHEME NAME (FOR @BindingOrientation SETTING SHOWN IN HEADER) (FOR SINGLE-ROW SIGNATURES: USE COLUMN FOOTERS)			
		ROTATE0 FLIP0	ROTATE90 FLIP90	ROTATE180 FLIP180	ROTATE270 FLIP270
left	top	Rotate0 Flip0	Rotate270/90* Flip90/270*	Rotate180 Flip180	Rotate90/270* Flip270/90*
	bottom	Flip0 Rotate0	Flip270/90* Rotate90/270*	Flip180 Rotate180	Flip90/270* Rotate270/90*
right	top	Flip180 Rotate180	Flip90/270* Rotate270/90*	Flip0 Rotate0	Flip270/90* Rotate90/270*
	bottom	Rotate180 Flip180	Rotate90/270* Flip270/90*	Rotate0 Flip0	Rotate270/90* Flip90/270*
top	left	Flip90 Rotate90	Flip180/0 Rotate180/0	Flip270 Rotate270	Flip0/180 Rotate0/180
	right	Rotate90 Flip90	Rotate0/180 Flip0/180	Rotate270 Flip270	Rotate180/0 Flip180/0
bottom	left	Rotate270 Flip270	Rotate180/0 Flip180/0	Rotate90 Flip90	Rotate0/180 Flip0/180
	right	Flip270 Rotate270	Flip0/180 Rotate0/180	Flip90 Rotate90	Flip180/0 Rotate180/0
		FLIP0 ROTATE0	FLIP270 ROTATE270	FLIP180 ROTATE180	FLIP90 ROTATE90

* **Important note:** If the binding edges appear horizontally on the diagram, the numbers must be swapped in the scheme names indicated by an asterisk ("Rotate90/270" would become "Rotate270/90"). This happens because the direction of rotation is reversed in those cases (e.g., "F8-7", "F12-7", "F16-10", etc.).

Table I.2: Transformations for each Scheme (Sheet 1 of 2)

SCHEME NAME	GETTING THE PAGINATION SCHEME (USING THE DIAGRAM)		
	PAGE NUMBERS	LEFT-BOUND PAGE	RIGHT-BOUND PAGE
Rotate0	Normal	As shown	As shown
Rotate0/180	Normal	As shown	Rotate 180°
Rotate90	Normal	Rotate 90° counterclockwise	Rotate 90° counterclockwise
Rotate90/270	Normal	Rotate 90° counterclockwise	Rotate 90° clockwise
Rotate180	Normal	Rotate 180°	Rotate 180°
Rotate180/0	Normal	Rotate 180°	As shown
Rotate270	Normal	Rotate 90° clockwise	Rotate 90° clockwise
Rotate270/90	Normal	Rotate 90° clockwise	Rotate 90° counterclockwise
Flip0	Reverse	Rotate 180°	Rotate 180°
Flip0/180	Reverse	Rotate 180°	As shown
Flip90	Reverse	Rotate 90° clockwise	Rotate 90° clockwise
Flip90/270	Reverse	Rotate 90° clockwise	Rotate 90° counterclockwise

Table I.2: Transformations for each Scheme (Sheet 2 of 2)

SCHEME NAME	GETTING THE PAGINATION SCHEME (USING THE DIAGRAM)		
	PAGE NUMBERS	LEFT-BOUND PAGE	RIGHT-BOUND PAGE
Flip180	Reverse	As shown	As shown
Flip180/0	Reverse	As shown	Rotate 180°
Flip270	Reverse	Rotate 90° counterclockwise	Rotate 90° counterclockwise
Flip270/90	Reverse	Rotate 90° counterclockwise	Rotate 90° clockwise

In the “Page Numbers” column in the above table, the value “Normal” refers to the main numbers in ▶ Table I.3 Original before transformation, ▶ Table I.5 Original before transformation and ▶ Table I.7 Pagination Diagrams, while “Reverse” refers to the smaller numbers in gray. Note that the small gray numbers have been omitted from ▶ Table I.4 Horizontal Binding Edges and ▶ Table I.6 Vertical Binding Edges. If they were shown, they would be the same as for ▶ Table I.3 Original before transformation and ▶ Table I.5 Original before transformation, respectively.

The “Left-Bound Pages” column in the above table refers to odd pages in the tables below, when looking at the main numbers. The “Right-Bound Pages” column in the above table refers to even pages.

Important note: When a page is rotated 90° (clockwise or counterclockwise), this rotation is made **inside** the signature cell. The cell itself is not rotated because the folding operation remains the same. This means that the aspect ratio of the page must have been designed accordingly.

I.1.5 Examples of applying BindingOrientation

The following examples describe the default orientation and pagination of *BinderySignature* depending on *@BindingOrientation*.

Note: The orientation of the final fold is defined in the production coordinate system. The binding side of the final product always defaults to left and is modified by *@BindingOrientation* regardless of whether the final fold in production is horizontal or vertical.

If the value of *@BindingOrientation* is one of the flip values, i.e. “Flip0”, “Flip90” etc, then the implied page ordering of the *BinderySignature* is reversed, e.g. for right to left reading order.

I.1.5.1 Signature with Horizontal Binding Edges

The examples below show how to read the diagrams after applying the transformations explained previously. Each diagram shows the pagination of the lay-side diagram defined for fold catalog “F8-7”, indicating the scheme name above it.

Table I.3: Original before transformation

SCHEME NAME	ILLUSTRATION
Rotate0	

Table I.4: Horizontal Binding Edges

SCHEME NAME	ILLUSTRATION	SCHEME NAME	ILLUSTRATION
Rotate0		Rotate180	

Table I.4: Horizontal Binding Edges

SCHEME NAME	ILLUSTRATION	SCHEME NAME	ILLUSTRATION
Rotate90		Rotate270	
Rotate0/180		Rotate180/0	
Rotate90/270		Rotate270/90	
Flip0		Flip180	
Flip90		Flip270	
Flip0/180		Flip180/0	
Flip90/270		Flip270/90	

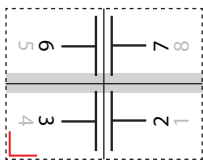
I.1.5.2 Signature with Vertical Binding Edges

The examples below show how to read the diagrams after applying the transformations explained previously. Each diagram is an interpretation of the lay-side diagram defined for fold catalog "F12-11", indicating the scheme name above it.

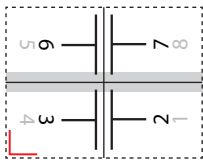
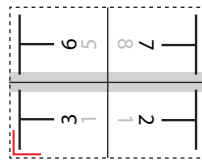
Table I.5: Original before transformation

SCHEME NAME	ILLUSTRATION
Rotate0	

Table I.6: Vertical Binding Edges

SCHEME NAME	ILLUSTRATION	SCHEME NAME	ILLUSTRATION
Rotate0		Rotate180	
Rotate90		Rotate270	
Rotate0/180		Rotate180/0	
Rotate90/270		Rotate270/90	
Flip0		Flip180	

Table I.6: Vertical Binding Edges

SCHEME NAME	ILLUSTRATION	SCHEME NAME	ILLUSTRATION
Flip90		Flip270	
Flip0/180		Flip180/0	
Flip90/270		Flip270/90	

I.2 Pagination Diagrams

Table I.7: Pagination Diagrams (Sheet 1 of 13)

FOLD CATALOG	GRID SIZE	DESCRIPTION
F2-1	1 x 1	
(No folding sequence)		
F4-1	2 x 1	
$\uparrow^{1/2}$		
F4-2	2 x 1	
$\downarrow^{1/2}$		
F6-1	3 x 1	
$\uparrow^{1/3} \downarrow^{1/3}$		
F6-2	3 x 1	
$\downarrow^{1/3} \uparrow^{1/3}$		
F6-3	3 x 1	Unsupported (gatefold)
$\downarrow^{1/4} \uparrow^{1/2}$		

Table I.7: Pagination Diagrams (Sheet 2 of 13)

FOLD CATALOG		GRID SIZE	DESCRIPTION
FOLDING SEQUENCE			
F6-4	3 x 1		
	$\uparrow^{1/3} \uparrow^{1/3}$		
F6-5	3 x 1		
	$\uparrow^{2/3} \downarrow^{1/3}$		
F6-6	3 x 1		Unsupported (multiple page sizes)
	$\uparrow^{3/4} \downarrow^{1/4}$		
F6-7	3 x 1		Unsupported (multiple page sizes)
	$\uparrow^{1/4} \downarrow^{1/4}$		
F6-8	3 x 1		
	$\uparrow^{2/3} \uparrow^{1/3}$		
F8-1	4 x 1		
	$\uparrow^{1/2} \uparrow^{1/4}$		
F8-2	4 x 1		
	$\uparrow^{1/2} \downarrow^{1/4}$		
F8-3	4 x 1		
	$\uparrow^{1/4} \downarrow^{1/4} \uparrow^{1/4}$		
F8-4	4 x 1		
	$\uparrow^{1/4} \uparrow^{1/2} \downarrow^{1/4}$		
F8-5	4 x 1		
	$\uparrow^{1/4} \uparrow^{1/4} \uparrow^{1/4}$		
F8-6	4 x 1		
	$\uparrow^{3/4} \downarrow^{1/4} \downarrow^{1/4}$		
F8-7	2 x 2		
	$\uparrow^{1/2} + \uparrow^{1/2}$		

Table I.7: Pagination Diagrams (Sheet 3 of 13)

FOLD CATALOG		GRID SIZE	DESCRIPTION
FOLDING SEQUENCE			
F10-1	5 x 1	$\uparrow^{1/5} \downarrow^{1/5} \uparrow^{1/5} \uparrow^{1/5}$	
F10-2	5 x 1	$\uparrow^{4/5} \downarrow^{1/5} \downarrow^{1/5} \downarrow^{1/5}$	
F10-3	5 x 1	$\uparrow^{2/5} \downarrow^{2/5} \uparrow^{1/5}$	
F12-1	6 x 1	$\uparrow^{1/3} \downarrow^{1/3} \uparrow^{1/6}$	
F12-2	6 x 1	$\uparrow^{1/3} \uparrow^{1/3} \downarrow^{1/6}$	
F12-3	6 x 1	$\uparrow^{1/2} \downarrow^{1/6} \uparrow^{1/6}$	
F12-4	6 x 1	$\uparrow^{1/2} \downarrow^{1/6} \downarrow^{1/6}$	
F12-5	6 x 1	$\uparrow^{1/2} \downarrow^{1/3} \uparrow^{1/6}$	
F12-6	6 x 1	$\uparrow^{1/6} \downarrow^{1/6} \uparrow^{1/6} \downarrow^{1/6} \uparrow^{1/6}$	
F12-7	3 x 2	$\uparrow^{1/3} \downarrow^{1/3} + \uparrow^{1/2}$	
F12-8	3 x 2	$\uparrow^{2/3} \uparrow^{1/3} + \uparrow^{1/2}$	

Table I.7: Pagination Diagrams (Sheet 4 of 13)

FOLD CATALOG		GRID SIZE	DESCRIPTION
FOLDING SEQUENCE			
F12-9	3 x 2	$\begin{matrix} \uparrow^{1/3} \uparrow^{1/3} \\ + \\ \uparrow^{1/2} \end{matrix}$	
F12-10	3 x 2	$\begin{matrix} \uparrow^{2/3} \downarrow^{1/3} \\ + \\ \uparrow^{1/2} \end{matrix}$	
F12-11	3 x 2	$\begin{matrix} \uparrow^{1/3} \\ + \\ \uparrow^{1/2} \\ + \\ \uparrow^{1/3} \end{matrix}$	
F12-12	2 x 3	$\begin{matrix} \uparrow^{1/2} \\ + \\ \uparrow^{2/3} \downarrow^{1/3} \end{matrix}$	
F12-13	2 x 3	$\begin{matrix} \uparrow^{1/2} \\ + \\ \uparrow^{1/3} \uparrow^{1/3} \end{matrix}$	
F12-14	2 x 3	$\begin{matrix} \uparrow^{1/2} \\ + \\ \uparrow^{1/3} \downarrow^{1/3} \end{matrix}$	
F14-1	7 x 1	$\uparrow^{1/7} \downarrow^{1/7} \uparrow^{1/7} \downarrow^{1/7} \uparrow^{1/7} \uparrow^{1/7}$	
F16-1	8 x 1	$\uparrow^{1/2} \downarrow^{1/4} \uparrow^{1/8}$	

Table I.7: Pagination Diagrams (Sheet 5 of 13)

FOLD CATALOG	GRID SIZE	DESCRIPTION
FOLDING SEQUENCE		
F16-2	8 x 1	
F16-3	8 x 1	
F16-4	8 x 1	
F16-5	8 x 1	
F16-6	4 x 2	
F16-7	4 x 2	
F16-8	4 x 2	
F16-9	4 x 2	
F16-10	4 x 2	

Table I.7: Pagination Diagrams (Sheet 6 of 13)

FOLD CATALOG		GRID SIZE	DESCRIPTION
FOLDING SEQUENCE			
F16-11	4 x 2		
$\begin{matrix} \uparrow^{1/4} \downarrow^{1/4} \uparrow^{1/4} \\ + \\ \uparrow^{1/2} \end{matrix}$			
F16-12	4 x 2		
$\begin{matrix} \uparrow^{1/4} \uparrow^{1/4} \uparrow^{1/4} \\ + \\ \uparrow^{1/2} \end{matrix}$			
F16-13	2 x 4		
$\begin{matrix} \uparrow^{1/2} \\ + \\ \uparrow^{1/2} \downarrow^{1/4} \end{matrix}$			
F16-14	2 x 4		
$\begin{matrix} \uparrow^{1/2} \\ + \\ \uparrow^{1/2} \uparrow^{1/4} \end{matrix}$			
F18-1	9 x 1		
$\uparrow^{1/9} \downarrow^{1/9} \uparrow^{1/9} \downarrow^{1/9} \uparrow^{1/9} \downarrow^{1/9} \uparrow^{1/9} \downarrow^{1/9}$			
F18-2	9 x 1		
$\uparrow^{2/3} \downarrow^{1/3} \uparrow^{1/9} \downarrow^{1/9}$			
F18-3	9 x 1		
$\uparrow^{1/3} \downarrow^{1/3} \uparrow^{2/9} \downarrow^{1/9}$			
F18-4	9 x 1		
$\uparrow^{1/3} \downarrow^{1/3} \uparrow^{1/9} \downarrow^{1/9}$			

Table I.7: Pagination Diagrams (Sheet 7 of 13)

FOLD CATALOG		GRID SIZE	DESCRIPTION
FOLDING SEQUENCE			
F18-5	3 x 3	$\begin{matrix} \uparrow^{1/3} \downarrow^{1/3} \\ + \\ \uparrow^{1/3} \downarrow^{1/3} \end{matrix}$	
F18-6	3 x 3	$\begin{matrix} \uparrow^{1/3} \downarrow^{1/3} \\ + \\ \uparrow^{2/3} \downarrow^{1/3} \end{matrix}$	
F18-7	3 x 3	$\begin{matrix} \uparrow^{1/3} \uparrow^{1/3} \\ + \\ \uparrow^{1/3} \downarrow^{1/3} \end{matrix}$	
F18-8	3 x 3	$\begin{matrix} \uparrow^{1/3} \uparrow^{1/3} \\ + \\ \uparrow^{2/3} \downarrow^{1/3} \end{matrix}$	
F18-9	3 x 3	$\begin{matrix} \uparrow^{2/3} \uparrow^{1/3} \\ + \\ \uparrow^{2/3} \uparrow^{1/3} \end{matrix}$	
F20-1	5 x 2	$\begin{matrix} \uparrow^{2/5} \downarrow^{2/5} \uparrow^{1/5} \\ + \\ \uparrow^{1/2} \end{matrix}$	
F20-2	5 x 2	$\begin{matrix} \uparrow^{1/5} \downarrow^{1/5} \uparrow^{1/5} \downarrow^{1/5} \\ + \\ \uparrow^{1/2} \end{matrix}$	

Table I.7: Pagination Diagrams (Sheet 8 of 13)

FOLD CATALOG		GRID SIZE	DESCRIPTION
FOLDING SEQUENCE			
F24-1		6 x 2	
	$\uparrow^{1/3} \downarrow^{1/3}$ $+$ $\uparrow^{1/2}$ $+$ $\uparrow^{1/6}$		
F24-2		6 x 2	
	$\uparrow^{1/3} \uparrow^{1/3}$ $+$ $\uparrow^{1/2}$ $+$ $\uparrow^{1/6}$		
F24-3		6 x 2	
	$\uparrow^{1/3} \downarrow^{1/3} \uparrow^{1/6}$ $+$ $\uparrow^{1/2}$		
F24-4		6 x 2	
	$\uparrow^{1/3} \downarrow^{1/3} \downarrow^{1/6}$ $+$ $\uparrow^{1/2}$		
F24-5		6 x 2	
	$\uparrow^{1/3} \uparrow^{1/3} \downarrow^{1/6}$ $+$ $\uparrow^{1/2}$		
F24-6		6 x 2	
	$\uparrow^{1/6} \downarrow^{1/6} \uparrow^{1/6} \downarrow^{1/6} \uparrow^{1/6}$ $+$ $\uparrow^{1/2}$		
F24-7		6 x 2	
	$\uparrow^{1/3}$ $+$ $\uparrow^{1/2}$ $+$ $\uparrow^{1/3} \downarrow^{1/6}$		

Table I.7: Pagination Diagrams (Sheet 9 of 13)

FOLD CATALOG	GRID SIZE	DESCRIPTION
FOLDING SEQUENCE		
F24-8	3 x 4	
F24-9	3 x 4	
F24-10	3 x 4	
F24-11	4 x 3	
F28-1	7 x 2	

Table I.7: Pagination Diagrams (Sheet 10 of 13)

FOLD CATALOG		GRID SIZE	DESCRIPTION
FOLDING SEQUENCE			
F32-1	16 x 1		
$\uparrow^{1/2} \downarrow^{1/4} \uparrow^{1/8} \downarrow^{1/16}$			
F32-2	8 x 2		
$\uparrow^{1/2} \downarrow^{1/4}$ + $\uparrow^{1/2}$ + $\uparrow^{1/8}$			
F32-3	8 x 2		
$\uparrow^{1/2} \downarrow^{1/4}$ + $\uparrow^{1/2}$ + $\downarrow^{1/8}$			
F32-4	4 x 4		
$\uparrow^{1/2}$ + $\uparrow^{1/2}$ + $\uparrow^{1/4}$ + $\uparrow^{1/4}$			
F32-5	4 x 4		
$\uparrow^{1/2}$ + $\uparrow^{1/2}$ + $\downarrow^{1/4}$ + $\downarrow^{1/4}$			
F32-6	4 x 4		
$\uparrow^{1/2}$ + $\uparrow^{1/2}$ + $\uparrow^{1/4}$ + $\downarrow^{1/4}$			

Table I.7: Pagination Diagrams (Sheet 11 of 13)

FOLD CATALOG		GRID SIZE	DESCRIPTION
FOLDING SEQUENCE			
F32-7	4 x 4	$\begin{matrix} \uparrow^{1/4} \downarrow^{1/4} \uparrow^{1/4} \\ + \\ \uparrow^{1/2} \downarrow^{1/4} \end{matrix}$	
F32-8	4 x 4	$\begin{matrix} \uparrow^{1/2} \downarrow^{1/4} \\ + \\ \uparrow^{1/2} \downarrow^{1/4} \end{matrix}$	
F32-9	4 x 4	$\begin{matrix} \uparrow^{1/2} \\ + \\ \uparrow^{1/2} \downarrow^{1/4} \\ + \\ \uparrow^{1/4} \end{matrix}$	
F36-1	9 x 2	$\begin{matrix} \uparrow^{1/3} \downarrow^{1/3} \uparrow^{1/9} \downarrow^{1/3} \\ + \\ \uparrow^{1/2} \end{matrix}$	
F36-2	6 x 3	$\begin{matrix} \uparrow^{1/3} \downarrow^{1/3} \\ + \\ \uparrow^{1/3} \downarrow^{1/3} \\ + \\ \uparrow^{1/6} \end{matrix}$	

Table I.7: Pagination Diagrams (Sheet 12 of 13)

FOLD CATALOG	GRID SIZE	DESCRIPTION
FOLDING SEQUENCE		
F40-1	5 x 4	<p> $\uparrow^{1/5} \downarrow^{1/5} \uparrow^{1/5} \downarrow^{1/5}$ $\uparrow^{1/2} \downarrow^{1/4}$ </p>
F48-1	6 x 4	<p> $\uparrow^{1/3} \downarrow^{1/3}$ $\uparrow^{1/4} \downarrow^{1/4} \uparrow^{1/4}$ $\uparrow^{1/6}$ </p>
F48-2	4 x 6	<p> $\uparrow^{1/4} \downarrow^{1/4} \uparrow^{1/4}$ $\uparrow^{1/3} \downarrow^{1/3} \uparrow^{1/6}$ </p>
F64-1	8 x 4	<p> $\uparrow^{1/2}$ $\uparrow^{1/4} \downarrow^{1/4} \uparrow^{1/4}$ $\uparrow^{1/4} \downarrow^{1/8}$ </p>

Table I.7: Pagination Diagrams (Sheet 13 of 13)

FOLD CATALOG	GRID SIZE	DESCRIPTION							
FOLDING SEQUENCE									
F64-2	8 x 4								
$ \begin{array}{c} \uparrow^{1/4} \downarrow^{1/4} \uparrow^{1/4} \\ + \\ \uparrow^{1/4} \downarrow^{1/4} \uparrow^{1/4} \\ + \\ \uparrow^{1/8} \end{array} $									

J Resolving Directory URL References

New in JDF 1.2

This appendix describes the detailed semantics of resolving [RunList/@Directory](#) and any associated [FileSpec/@URL](#) URI references in any of the [RunList](#) refelements.

J.1 Semantics of the [RunList/@Directory](#) attribute

The [@Directory](#) attribute defines a directory where the files that are associated with this [RunList](#) SHOULD be copied to or from. If [@Directory](#) is specified, it SHALL be an absolute URI ▶ [RFC3986] that implicitly also specifies a base URI that is used to resolve any relative URI attribute in the [RunList](#) structure. As such, [@Directory](#) SHALL start with a URL scheme, such as "file" or "ftp", MAY contain an authority, such as "///any.com" and SHOULD contain an absolute path that ends with a "/" to indicate a directory.¹ For example: "file:///any.com/pub/doc-archives/" or "file:///pub/doc-archives/".

If [@Directory](#) is not specified, the absolute URI that specifies the directory in which the **JDF** file resides is used as the base URI to resolve each relative [@URL](#) attribute in the [RunList](#).

If the [FileSpec/Container/FileSpec](#) resource is supplied indicating that the [FileSpec](#) is contained in another file, the base URI is the absolute URI of where the **JDF** consumer extracted the container file (whether or not [@Directory](#) is specified). See ▶ Section 8.58 FileSpec.

After determining the base URI depending on the presence or absence of [RunList/@Directory](#) and [FileSpec/Container/FileSpec](#) resource as described above, each [@URL](#) attribute in a [RunList](#) refelement (e.g., [LayoutElement/FileSpec/@URL](#) or [InsertSheet/Layout/Media/QualityControlResult/FileSpec/@URL](#)) is used in combination with the base URI to form the resolved URI as follows according to one of the following mutually exclusive patterns.²

- 1 [RunList @URL](#) starts with a scheme (token ending with ":" (e.g., "file:" or "cid:")):³
 - Resolved URI = the entire [RunList](#) URL (and the base URI is ignored).
- 2 [RunList @URL](#) starts with an authority/host (starts with "//" (e.g., "///www.cip4.org")):
 - Resolved URI = the base URI scheme, followed by the [RunList](#) URL authority/host followed by its absolute path (which MAY be empty).
- 3 [RunList @URL](#) starts with an absolute path (starts with "/" (e.g., "/pub/document-archives")):
 - Resolved URI = the base URI scheme and its authority (if any) followed by the [RunList](#) URL absolute path.
- 4 [RunList @URL](#) starts with a relative path (starts with something other than "/" (e.g., "foo.pdf", "./folder/foo.pdf", "../foo.pdf", etc.):
 - Resolved URI = the base URI scheme, its authority (if any), and its absolute path (if any) up to and including the right-most "/", followed by the [RunList @URL](#) relative path with ".", ".." and "/" segments removed.

The above algorithm is only a summary. See ▶ [RFC3986] for the detailed algorithm. and ▶ [FileURL] for examples.

-
1. According to ▶ [RFC3986] section 5.2 "Resolve Relative References to Absolute Form", the characters following the right-most "/" if any, are removed from the base URI, in order to resolve a relative URI with the base URI. So be sure to end the [@Directory](#) value with a "/" to make it clear that [@Directory](#) is a reference to a directory and not a file, and to ensure that the last path segment won't get removed in resolving the URI reference.
 2. The resolved URI is formed assuming that URI query and fragments are *not* used in JDF.
 3. In order to improve interoperability and to simplify implementation, JDF follows the strict-parsing rules of ▶ [RFC3986] so that even if the [FileSpec/@URL](#) attribute starts with the same scheme as the base URI, the entire URL values is always interpreted as an absolute URI and always replaces the base URI to form the resolved URI. This strict rule is especially important for interoperability. Consider the case in which the JDF producer drops the JDF into a hot folder but does NOT specify [RunList/@Directory](#) so that the JDF consumer has to generate the base URI for the hot folder in order to resolve the [FileSpec/@RunList](#), but the producer is supplying a [FileSpec/@URL](#) that is relative to the hot folder. If the JDF producer supplies the scheme in the [FileSpec/@URL](#), then the JDF producer would have to supply the same scheme as the JDF consumer generates for the base URI for hot folder, in order for the relative URI semantics to apply. However, under non-strict parsing, if the JDF producer guesses wrong (say one is "file:" and the other is "ftp:"), the JDF consumer would interpret [FileSpec/@URL](#) as an absolute URI.

Appendix K

K Hole Pattern Catalog

The following table defines the specifics of the predefined holes in [HoleMakingParams](#) and [HoleMakingIntent](#).

Notes:

- 1 All patterns are centered on the sheet along the reference edge.
- 2 The reference edge is always defined relative to a portrait orientation of the medium, regardless of the orientation of the printed image or processing path.
- 3 The pattern axis offset is always specified relative to the reference edge.
- 4 The default pattern axis offset is always specified in points.
- 5 Thumbcuts are available in various standard shapes (labeled “No. N” where N is minimally ranging from 2..7). “No. 3” seems to be the most widely used.
- 6 Single thumbcuts appear always in the center of the reference edge.
- 7 Oval-shaped holes sometimes actually look more like rectangular holes with rounded corners.
- 8 Generic hole types are dependent on the geographical area where the device is used.

Sources:

- 1 Printer Finishing MIB ▶ [RFC3806]
- 2 Files and folders; concepts ▶ [DIN 821-3]
- 3 Paper; Holes for general filing purposes; Specifications ▶ [ISO838]
- 4 Paper and board - Dimensions for standard punching of A4 and A5 paper ▶ [DIN 5005]

K.1 Naming Scheme

Table K.1: Naming Scheme for Hole Patterns

NAME	DESCRIPTION
General	<m i>: m = metric (millimeter is used), i = imperial (inch, where 1 inch = 25.4 mm)
Ring Binding	R<#holes><m i>-<variant> Example: R2m-DIN = RingBind, 2 hole, metric, DIN
Plastic Comb	P<pitch><m i>-<shape>-<#thumbcuts>t Example: P16:9m-round-0t = Plastic Comb, 9/16" pitch (16:9), round, no thumbcut
Wire Comb	W<pitch><m i>-<shape>-<#thumbcuts>t Example: W2:1i-square-1t = Wire Comb, 1/2" pitch (2:1), square, one thumbcut
Coil/Spiral	C<pitch><m i>-<shape>-<#thumbcuts>t Example: C9.5m-round-0t = Coil, 9.5 mm, round, no thumbcut
Special	S<#holes> Example: S1-generic

K.2 Ring Binding - Two Hole

Table K.2: Hole Details for R2 Series

HOLE PATTERN ID	DESCRIPTION	SHAPE	HOLE EXTENT	PATTERN GEOMETRY	PATTERN AXIS OFFSET	JDF DEFAULT PATTERN AXIS OFFSET	EDGE	NOTE	SOURCE
R2-generic	Generic request of a 2-hole pattern	●	5 - 13 mm 0.2-0.51"	N/A	4.5 - 13 mm 0.18 - 0.51"	34.02 (≅ 12 mm)	Left	See note (8)	N/A
R2m-DIN	DIN 2-hole MIB: 6 = two-HoleDIN and 10 = twoHole-Metric	●	5.5 ± 0.1 mm	80 ± 0.1 mm	7 or 11 ± 0.3 mm 7 mm for blocks of <= 15 mm thick	31.18 (≅ 11 mm)	Left	A4 and A5	[DIN 5005] [DIN 821-3]
R2m-ISO	ISO 2-hole MIB: 6 = two-HoleDIN and 10 = twoHole-Metric	●	6 ± 0.5 mm	80 ± 0.5 mm	12 ± 1 mm Australian Standard AS P5-1969: 10 ± 1 mm	34.02 (≅ 12 mm)	Left	Also used in Japan	[ISO838]
R2m-MIB	Printer Finishing MIB twoHoleDIN and twoHole-Metric	●	5-8 mm	80 ± 0.5 mm	4.5 - 13 mm	31.18 (≅ 11 mm)	Left		[RFC3806]
R2i-US-a	US 2-hole, Variant A MIB: 4 = two-HoleUSTop and 12 = twoHole-USSide	●	0.2 - 0.32"	2.75"	0.18 - 0.51"	29.25 (≅ 13/32")	Left for letter Top for ledger		[RFC3806]
R2i-US-b	US 2-hole, Variant B	●	0.2 - 0.5" std: 5/16" typ: 1/4", 9/32", 11/32", 3/8", 13/32", 1/2"	6"	0.25" + 1/2 diameter Range: 6/16" - 1/2"	29.25 (≅ 13/32")	Left		

K.3 Ring Binding - Three Hole

Table K.3: Hole Details for R3 Series

HOLE PATTERN ID	DESCRIPTION	SHAPE	HOLE EXTENT	PATTERN GEOMETRY	PATTERN AXIS OFFSET	JDF DEFAULT PATTERN AXIS OFFSET	EDGE	NOTE	SOURCE
R3-generic	Generic request of a 3-hole pattern.	●	5 - 13 mm 0.2-0.51"	N/A	4.5 - 13 mm 0.18 - 0.51"	29.25 (≅ 13/32")	Left	See note (8)	N/A

Table K.3: Hole Details for R3 Series

HOLE PATTERN ID	DESCRIPTION	SHAPE	HOLE EXTENT	PATTERN GEOMETRY	PATTERN AXIS OFFSET	JDF DEFAULT PATTERN AXIS OFFSET	EDGE	NOTE	SOURCE
R3i-US	US 3-hole MIB: 5 = threeHoleUS	●	0.2 - 0.5" std: 5/16" typ: 1/4", 9/32", 11/ 32", 3/ 8", 13/ 32", 1/2"	4.25"	0.25" + 1/2 diameter range: 6/16" - 1/ 2"	29.25 (≅ 13/32")	Left		[RFC3806]

K.4 Ring Binding - Four Hole

Table K.4: Hole Details for R4 Series

HOLE PATTERN ID	DESCRIPTION	SHAPE	HOLE EXTENT	PATTERN GEOMETRY	PATTERN AXIS OFFSET	JDF DEFAULT PATTERN AXIS OFFSET	EDGE	NOTE	SOURCE
R4-generic	Generic request of a 4-hole pattern.	●	5 - 13 mm 0.2-0.51"	N/A	4.5 - 13 mm 0.18 - 0.51"	31.18 (≅ 11 mm)	Left	See note (8)	N/A
R4m-DIN-A4	DIN 4-hole for A4	●	5.5 ± 0.1 mm	80 ± 0.1 mm	7 or 11 ± 0.3 mm 7 mm for blocks of 15 mm or less	31.18 (≅ 11 mm)	Left	A4	[DIN 5005] [DIN 821-3]
R4m-DIN-A5	DIN 4-hole for A5	●	5.5 ± 0.1 mm	45-65-45 mm	7 or 11 ± 0.3 mm 7 mm for blocks of 15 mm or less	31.18 (≅ 11 mm)	Left	A5	[DIN 5005]
R4m-swedish	Swedish 4-hole MIB: 11 = swedish4Hole	●	5 - 8 mm	21-70-21 mm	4.5 - 13 mm	31.18 (≅ 11 mm)	Left for A4 Top for A3	A4, A3	[RFC3806]
R4i-US	US 4-hole	●	0.2 - 0.5" std: 5/16" typ: 1/4", 9/32", 11/ 32", 3/ 8", 13/ 32", 1/2"	1.375-4.25- 1.375"	0.25" + 1/2 diameter Range: 6/16" - 1/ 2"	29.25 (≅ 0.25" + 1/2 x 5/16" = 13/32")	Left		

K.5 RingBinding - Five Hole

Table K.5: Hole Details for R5 Series

HOLE PATTERN ID	DESCRIPTION	SHAPE	HOLE EXTENT	PATTERN GEOMETRY	PATTERN AXIS OFFSET	JDF DEFAULT PATTERN AXIS OFFSET	EDGE	NOTE	SOURCE
R5-generic	Generic request of a 5-hole pattern.	●	5 - 13 mm 0.2-0.51"	N/A	4.5 - 13 mm 0.18 - 0.51"	29.25 ($\cong 13/32$ "	Left	See note (8)	N/A
R5i-US-a	US 5-hole, Variant A MIB: 13 = five-HoleUS	●	0.2 - 0.32"	2-2.25-2.25-2"	0.18 - 0.51"	29.25 ($\cong 13/32$ "	Left for letter Top for ledger		[RFC3806]
R5i-US-b	US 5-hole, Variant B	●	0.2 - 0.5" std: 5/16" typ: 1/4", 9/32", 11/32", 3/8", 13/32", 1/2"	0.75-3.5-3.5-0.75"	0.25" + 1/2 diameter 0.375 - 0.5"	29.25 ($\cong 0.25$ " + 1/2 x 5/16" = 13/32")	Left		
R5i-US-c	Combination of R2i-US-a and R3i-US	●	0.2 - 0.5" std: 5/16" typ: 1/4", 9/32", 11/32", 3/8", 13/32", 1/2"	1.25-3-3-1.25"	0.25" + 1/2 diameter 0.375 - 0.5"	29.25 ($\cong 0.25$ " + 1/2 x 5/16" = 13/32")	Left		

K.6 Ring Binding - Six Hole

Table K.6: Hole Details for R6 Series (Sheet 1 of 2)

HOLE PATTERN ID	DESCRIPTION	SHAPE	HOLE EXTENT	PATTERN GEOMETRY	PATTERN AXIS OFFSET	JDF DEFAULT PATTERN AXIS OFFSET	EDGE	NOTE	SOURCE
R6-generic	Generic request of a 6-hole pattern.	●	5 - 13 mm 0.2-0.51"	N/A	4.5 - 13 mm 0.18 - 0.51"	31.18 ($\cong 11$ mm)	Left for A4/A5 Top for A3	See note (8)	N/A
R6m-4h2s	Norwegian 4-hole (round) mixed with 2 slots (rectangular) MIB: 16 = norwegian6Hole	H: ● S: ■	Holes: 5 - 8 mm Slots: 10 x 5.5 mm	4 holes/2 slots Pattern: H-H-S-S-H-H 64-18.5-75-18.5-64 mm	4.5 - 13 mm	31.18 ($\cong 11$ mm)	Left for A4 Top for A3		[RFC3806]

Table K.6: Hole Details for R6 Series (Sheet 2 of 2)

HOLE PATTERN ID	DESCRIPTION	SHAPE	HOLE EXTENT	PATTERN GEOMETRY	PATTERN AXIS OFFSET	JDF DEFAULT PATTERN AXIS OFFSET	EDGE	NOTE	SOURCE
R6m-DIN-A5	DIN 6-hole for A5	●	5.5 ± 0.1 mm	37.5-7.5-65-7.5-37.5 mm	7 or 11 ± 0.3 mm 7 mm for blocks of ≤ 15 mm thick	31.18 (≅ 11 mm)	Left	Only used with A5	[DIN 5005]



K.7 Ring Binding - Seven Hole

Table K.7: Hole Details for R7 Series

HOLE PATTERN ID	DESCRIPTION	SHAPE	HOLE EXTENT	PATTERN GEOMETRY	PATTERN AXIS OFFSET	JDF DEFAULT PATTERN AXIS OFFSET	EDGE	NOTE	SOURCE
R7-generic	Generic request of a 7-hole pattern.	●	5 - 13 mm 0.2-0.51"	N/A	4.5 - 13 mm 0.18 - 0.51"	29.25 (≅ 13/32")	Left for letter Top for ledger	See note (8)	N/A
R7i-US-a	US 7-hole, Variant A MIB: 14 = sevenHoleUS	●	0.2 - 0.32"	1-1-2.25-2.25-1-1"	0.18 - 0.51"	29.25 (≅ 13/32")	Left for letter Top for ledger		[RFC3806]
R7i-US-b	US 7-hole, Bell/AT&T Systems. Combination of R3i-US, R4i-US, R5i-US-b	●	0.2 - 0.5" std: 5/16" typ: 1/4", 9/32", 11/32", 3/8", 13/32", 1/2"	0.75-1.375-2.125-2.125-1.375-0.75"	0.25" + 1/2 diameter 0.375 - 0.5"	29.25 (≅ 0.25" + 1/2 x 5/16" = 13/32")	Left for letter Top for ledger		
R7i-US-c	US 7-hole, Variant C	●	0.2 - 0.5" std: 5/16" typ: 1/4", 9/32", 11/32", 3/8", 13/32", 1/2"	1.25-0.875-2.125-2.125-0.875-1.25"	0.25" + 1/2 diameter 0.375 - 0.5"	29.25 (≅ 13/32")	Left for letter Top for ledger		





K.8 Ring Binding - Eleven Hole

Table K.8: Hole Details for R11 Series

HOLE PATTERN ID	DESCRIPTION	SHAPE	HOLE EXTENT	PATTERN GEOMETRY	PATTERN AXIS OFFSET	JDF DEFAULT PATTERN AXIS OFFSET	EDGE	NOTE	SOURCE
R11m-7h4s	7-hole (round) mixed with 4 slots (rectangular) MIB: 15 = mixed7H4S	H:  S:  	Holes: 5 - 8 mm Slots: 12 x 6 mm	7 holes/ 2slots Pattern: H-S-H-H-S-H-S-H-H-S-H 15-25-23-20-37-37-20-23-25-15 mm	4.5 - 13 mm	31.18 (≅ 11 mm)	Left for A4 Top for A3		[RFC3806]

K.9 Plastic Comb Binding

Table K.9: Hole Details for P Series

HOLE PATTERN ID	DESCRIPTION	SHAPE	HOLE EXTENT	PATTERN GEOMETRY	PATTERN AXIS OFFSET	JDF DEFAULT PATTERN AXIS OFFSET	EDGE	NOTE	SOURCE
P16_9i-rect-0t	US spacing, no thumbcut MIB: 9 = nineteenHoleUS A4: 21 Hole Letter: 19 Hole	 	5/16" x 1/8" (8 x 3.2 mm)	9/16"	3/16"	13.54 (≅ 0.188")	Left		[RFC3806]
P12m-rect-0t	European spacing, no thumbcut	 	7 x 3 mm	12 mm	4.5 mm	12.76 (≅ 4.5 mm)	Left		

K.10 Wire Comb Binding

Wire comb binding uses twenty-three holes for pages of A4 size, and twenty-one holes for pages of letter size.

Table K.10: Hole Details for W Series

HOLE PATTERN ID	DESCRIPTION	SHAPE	HOLE EXTENT	PATTERN GEOMETRY	PATTERN AXIS OFFSET	JDF DEFAULT PATTERN AXIS OFFSET	EDGE	NOTE	SOURCE
W2_1i-round-0t	2:1, round, no thumbcut MIB: 8 = twentyTwo-HoleUS A4: 23 Hole Letter: 21 Hole	●	0.2 - 0.32" std: 1/4" Europe typ: 6 or 6.4 mm	1/2"	3 mm + 1/2 diameter 0.318 - 0.438" Europe: 6 - 6.2 mm	17.50 (≅ 0.243")	Left		[RFC3806]
W2_1i-square-0t	2:1, square, no thumbcut A4: 23 Hole Letter: 21 Hole	■	0.2 - 0.32" std: 1/4" Europe typ: 6 or 6.4 mm	1/2"	3 mm + 1/2 diameter 0.318 - 0.438" Europe: 6 - 6.2 mm	17.50 (≅ 0.243")	Left		
W3_1i-square-0t	3:1, square, no thumbcuts A4: 34 Hole A5: 24 Hole Letter: 32 Hole	■	5/32 x 5/32" (4x4 mm)	1/3"	0.2"	14.40 (≅ 0.2")	Left		

K.11 Coil and Spiral Binding

Table K.11: Hole Details for C Series

HOLE PATTERN ID	DESCRIPTION	SHAPE	HOLE EXTENT	PATTERN GEOMETRY	PATTERN AXIS OFFSET	JDF DEFAULT PATTERN AXIS OFFSET	EDGE	NOTE	SOURCE
C9.5m-round-0t	9.5 mm, round, no thumbcut MIB: 17 = metric26Hole and 18 = metric30Hole A4: 30 Hole A3: 30 Hole JIS: 26 Hole B4: 26 Hole B5: 26 Hole	●	5 - 8 mm	9.5 mm	4.5 - 13 mm	31.18 (≅ 11 mm)	Left for A4/JIS B5 Top for A3/JIS B4		[RFC3806]

K.12 Special Binding

Table K.12: Hole Details for S Series

HOLE PATTERN ID	DESCRIPTION	SHAPE	HOLE EXTENT	PATTERN GEOMETRY	PATTERN AXIS OFFSET	JDF DEFAULT PATTERN AXIS OFFSET	EDGE	NOTE	SOURCE
S-generic	Generic request of a hole pattern with an arbitrary or unknown number of holes (e.g., an inline shotgun)	●	5 - 13 mm 0.2-0.51"	N/A	N/A	N/A	Any		N/A
S1-generic	Generic request of a hole pattern with 1 hole	●	5 - 13 mm 0.2-0.51"	N/A	N/A	N/A	Any		N/A

Appendix L

L FileSpec Use Cases

New in JDF 1.2

The purpose of this appendix is to give a series of use cases with examples for the use of the attributes of **FileSpec**: **@MimeType**, **@URL**, **@Compression** and the **FileSpec/Container** subelement. These use cases include container packaging files, such as tar, zip and Multipart/Related files and container compression and encoding files, each of which require one or more **Container** subelements to link one **FileSpec** with its container **FileSpec**.

L.1 Examples of Attribute Values of FileSpec

► Table L.1 Use Cases showing MimeType, URL and Compression Attribute Values shows a number of use cases and the corresponding values for the **@MimeType**, **@URL** and **@Compression** attributes. Each **Container** element points to the **FileSpec** shown on the next row in the table. The use cases are arranged in order of increasing complexity.

Note: All of the **@URL** examples in this appendix for **FileSpec** resources that are not contained in other files are absolute URIs, so that the complication of resolving **FileSpec/@URI** with **RunList/@Directory** is not considered. Of course, the **@URL** examples for **FileSpec** resources that are contained in other files SHALL all be relative URIs (relative to the base URI that is defined to be the absolute URI of where the **JDF** consumer extracted the container file) as the **JDF** spec requires (see the **@URL** description at ► Section 8.58 FileSpec).

Table L.1: Use Cases showing MimeType, URL and Compression Attribute Values (Sheet 1 of 2)

DESCRIPTION OF USE CASE	MIME TYPE	URL	COMPRESSION
1.) Single a.pdf PDF file, no compression	application/pdf	ftp://www.any.com/share/a.pdf	
2.) Single a.pdf PDF file, with gzip compression	application/pdf	a.pdf	Gzip
Container FileSpec	Gzip	ftp://www.any.com/a.gz	
3.) Single a.pdf PDF file, no compression, but Base64 encoded	application/pdf	a.pdf	Base64
Container FileSpec	Base64	ftp://www.any.com/a.mme	
4.) Single PDF file, no compression, but BinHex encoded into a BinHex file	application/pdf	a.pdf	BinHex
Container FileSpec	application/mac-binhex40	ftp://www.any.com/a.hqx	
5.) Single a.pdf PDF file with ZLIB compression in b.zip zip file (containing one or more files)	application/pdf	a.pdf	ZLIB
Container FileSpec	application/zip	ftp://www.any.com/b.zip	
6.) Single a.pdf PDF file compressed by Deflate in a b.zip with one or more files, and the b.zip packaging file itself is Base64 encoded as b.mme. To read, unencode, then decompress. To write, compress, then encode.	application/pdf	a.pdf	Deflate
Container FileSpec	application/zip	b.zip	Base64

Table L.1: Use Cases showing MimeType, URL and Compression Attribute Values (Sheet 2 of 2)

DESCRIPTION OF USE CASE	MIME TYPE	URL	COMPRESSION
Container FileSpec	Base64	ftp://www.any.com/b.mme	
7.) Single myFiles/myPicture.jpg file in myNestedZip.zip file with one or many files, but the myNestedZip.zip is itself zipped into c.zip.	image/jpeg	myFiles/myPicture.jpg	Deflate
Container FileSpec	application/zip	myNestedZip.zip	Deflate
Container FileSpec	application/zip	ftp://www.any.com/c.zip	
8.) Single a.pdf PDF file which is ZLIB compressed, in a c.zip with one or many files which is contained in a tar file and compressed with ZLIB into a.tar.gz file.	application/pdf	a.pdf	ZLIB
Container FileSpec	application/zip	c.zip	
Container FileSpec	Tar ^a	d.tar	ZLIB
Container FileSpec	GZip	ftp://www.any.com/d.tar.gz	

a. The UNIX Tar file packaging format is not registered with IANA as a MIME media type, so CIP4 has assigned the "Tar" file type to it for use in the [FileSpec/@MimeType](#) attribute.

L.2 Corresponding XML examples

The above use case examples are represented in XML as follows:

Example L.1: FileSpec #1

Single a.pdf PDF file, no compression:

```
<FileSpec Class="Parameter" ID="F1" MimeType="application/pdf"
  Status="Available" URL="ftp://www.any.com/share/a.pdf"/>
```

Example L.2: FileSpec #2

Single a.pdf PDF file, with Gzip compression:

```
<FileSpec Class="Parameter" Compression="Gzip" ID="F1"
  MimeType="application/pdf" Status="Available" URL="a.pdf">
  <Container>
    <FileSpec MimeType="Gzip" URL="ftp://www.any.com/a.gz"/>
  </Container>
</FileSpec>
```

Example L.3: FileSpec #3

Single a.pdf PDF file, no compression, but Base64 encoded:

```
<FileSpec Class="Parameter" Compression="Base64" ID="F1"
  MimeType="application/pdf" Status="Available" URL="a.pdf">
  <Container>
    <FileSpec MimeType="Base64" URL="ftp://www.any.com/a.mme"/>
  </Container>
</FileSpec>
```

Example L.4: FileSpec #4

Single PDF file, no compression, but BinHex encoded:

```
<FileSpec Class="Parameter" Compression="BinHex" ID="F1"
  MimeType="application/pdf" Status="Available" URL="a.pdf">
  <Container>
    <FileSpec MimeType="application/mac-binhex40" URL="ftp://www.any.com/a.hqx"/>
  </Container>
</FileSpec>
```

Example L.5: FileSpec #5

Single a.pdf PDF file, in b.zip zip file containing one or more files:

```
<FileSpec Class="Parameter" Compression="ZLIB" ID="F1"
  MimeType="application/pdf" Status="Available" URL="a.pdf">
  <Container>
    <FileSpec MimeType="application/zip" URL="ftp://www.any.com/b.zip"/>
  </Container>
</FileSpec>
```

Example L.6: FileSpec #6

Single a.pdf PDF file, in a b.zip with one or more files, and the b.zip packaging file itself is Base64 encoded as b.mme. To read, decode, then decompress. To write, compress, then encode.

```
<FileSpec Class="Parameter" Compression="Deflate" ID="F1"
  MimeType="application/pdf" Status="Available" URL="a.pdf">
  <Container>
    <FileSpec Compression="Base64" MimeType="application/zip" URL="b.zip">
      <Container>
        <FileSpec MimeType="Base64" URL="ftp://www.any.com/b.mme"/>
      </Container>
    </FileSpec>
  </Container>
</FileSpec>
```

Example L.7: FileSpec #7

Single myFiles/myPicture.jpg file in myNestedZip.zip file with one or many files, but the myNestedZip.zip is itself zipped into c.zip

```
<FileSpec Class="Parameter" Compression="Deflate" ID="F1"
  MimeType="image/jpeg" Status="Available" URL="myFiles/myPicture.jpg">
  <Container>
    <FileSpec Compression="Deflate" MimeType="application/zip" URL="myNestedZip.zip">
      <Container>
        <FileSpec MimeType="application/zip" URL="ftp://www.any.com/c.zip"/>
      </Container>
    </FileSpec>
  </Container>
</FileSpec>
```

Example L.8: FileSpec #8

Single a.pdf PDF file, which is ZLIB compressed in a c.zip with one or many files which is contained in a tar file and compressed with ZLIB into a.tar.gz file.:

```
<FileSpec Class="Parameter" Compression="ZLIB" ID="F1"
  MimeType="application/pdf" Status="Available" URL="a.pdf">
  <Container>
    <FileSpec MimeType="application/zip" URL="c.zip">
      <Container>
        <FileSpec Compression="ZLIB" MimeType="Tar" URL="d.tar">
          <Container>
            <FileSpec MimeType="GZip" URL="ftp://www.any.com/d.tar.gz"/>
          </Container>
        </FileSpec>
      </Container>
    </FileSpec>
  </Container>
</FileSpec>
```

L.3 Additional examples showing Partitioning of FileSpec

This section has additional examples of container files and various schemes of partitioning.

Example L.9: FileSpec #9

Package b.zip contains multiple pdf files a.pdf, b.pdf etc.

```
<FileSpec Class="Parameter" ID="ID_002" MimeType="application/zip"
  Status="Available" URL="ftp://www.any.com/b.zip"/>
<FileSpec Class="Parameter" Compression="Deflate" ID="A_FILE"
  MimeType="application/pdf" Status="Available" URL="a.pdf">
  <Container>
    <FileSpecRef rRef="ID_002"/>
  </Container>
</FileSpec>
<FileSpec Class="Parameter" Compression="Deflate" ID="B_FILE"
  MimeType="application/pdf" Status="Available" URL="b.pdf">
  <Container>
    <FileSpecRef rRef="ID_002"/>
  </Container>
</FileSpec>
```

Example L.10: FileSpec #10

Package b.zip contains two pdf files a.pdf, b.pdf and a tiff, c.tiff used by a partitioned resource

```
<FileSpec Class="Parameter" ID="ID_003" MimeType="application/zip"
  Status="Available" URL="ftp://www.any.com/b.zip"/>
<FileSpec Class="Parameter" Compression="Deflate" ID="ALL_FILES"
  MimeType="application/pdf" PartIDKeys="PartVersion" Status="Available">
  <Container>
    <FileSpecRef rRef="ID_003"/>
  </Container>
  <FileSpec PartVersion="English" URL="a.pdf"/>
  <FileSpec PartVersion="French" URL="b.pdf"/>
  <FileSpec MimeType="application/tif" PartVersion="German" URL="c.tif"/>
</FileSpec>
```

Example L.11: FileSpec #11

Single a.pdf PDF file, in b.zip which is contained in c.tar file:

```
<FileSpec Class="Parameter" ID="ID_004_TAR" MimeType="Tar"
  Status="Available" URL="ftp://www.any.com/c.tar"/>
<FileSpec Class="Parameter" ID="ID_004_ZIP"
  MimeType="application/zip" Status="Available" URL="b.zip">
  <Container>
    <FileSpecRef rRef="ID_004_TAR"/>
  </Container>
</FileSpec>
<FileSpec Class="Parameter" Compression="Deflate" ID="C_FILE"
  MimeType="application/pdf" Status="Available" URL="a.pdf">
  <Container>
    <FileSpecRef rRef="ID_004_ZIP"/>
  </Container>
</FileSpec>
```

Example L.12: FileSpec #11.1 — No Partitioning

Multiple files in several zip's contained in a tar file, various examples with and without partitioning. So the file layout looks like:

```
e.tar
c.zip
a.pdf
b.pdf
d.zip
a.pdf
b.pdf
```

```
<FileSpec Class="Parameter" ID="ID_005_TAR" MimeType="Tar"
  Status="Available" URL="ftp://www.any.com/e.tar"/>
<FileSpec Class="Parameter" ID="ID_005_ZIP_C"
  MimeType="application/zip" Status="Available" URL="c.zip">
  <Container>
    <FileSpecRef rRef="ID_005_TAR"/>
  </Container>
</FileSpec>
<FileSpec Class="Parameter" ID="ID_005_ZIP_D"
  MimeType="application/zip" Status="Available" URL="d.zip">
  <Container>
    <FileSpecRef rRef="ID_005_TAR"/>
  </Container>
</FileSpec>
<FileSpec Class="Parameter" Compression="Deflate"
  ID="A_ENGLISH_FILE" MimeType="application/pdf" Status="Available" URL="a.pdf">
  <Container>
    <FileSpecRef rRef="ID_005_ZIP_C"/>
  </Container>
</FileSpec>
<FileSpec Class="Parameter" Compression="Deflate"
  ID="B_ENGLISH_FILE" MimeType="application/pdf" Status="Available" URL="b.pdf">
  <Container>
    <FileSpecRef rRef="ID_005_ZIP_C"/>
  </Container>
</FileSpec>
<FileSpec Class="Parameter" Compression="Deflate" ID="A_GERMAN_FILE"
  MimeType="application/pdf" Status="Available" URL="a.pdf">
  <Container>
    <FileSpecRef rRef="ID_005_ZIP_D"/>
  </Container>
</FileSpec>
<FileSpec Class="Parameter" Compression="Deflate" ID="B_GERMAN_FILE"
  MimeType="application/pdf" Status="Available" URL="b.pdf">
  <Container>
    <FileSpecRef rRef="ID_005_ZIP_D"/>
  </Container>
</FileSpec>
```

```

<FileSpec Class="Parameter" ID="ID_004_TAR" MimeType="Tar"
  Status="Available" URL="ftp://www.any.com/c.tar"/>
<FileSpec Class="Parameter" ID="ID_004_ZIP"
  MimeType="application/zip" Status="Available" URL="b.zip">
  <Container>
    <FileSpecRef rRef="ID_004_TAR"/>
  </Container>
</FileSpec>
<FileSpec Class="Parameter" Compression="Deflate" ID="C_FILE"
  MimeType="application/pdf" Status="Available" URL="a.pdf">
  <Container>
    <FileSpecRef rRef="ID_004_ZIP"/>
  </Container>
</FileSpec>

```

Example L.13: FileSpec #11.2 — Intermediate container Partitioned

```

<FileSpec Class="Parameter" ID="ID_005_TAR" MimeType="Tar"
  Status="Available" URL="ftp://www.any.com/e.tar"/>
<FileSpec Class="Parameter" ID="ID_005_ZIPS"
  MimeType="application/zip" PartIDKeys="PartVersion" Status="Available">
  <Container>
    <FileSpecRef rRef="ID_005_TAR"/>
  </Container>
  <FileSpec PartVersion="English" URL="c.zip"/>
  <FileSpec PartVersion="German" URL="d.zip"/>
</FileSpec>
<FileSpec Class="Parameter" Compression="Deflate"
  ID="A_ENGLISH_FILE" MimeType="application/pdf" Status="Available" URL="a.pdf">
  <Container>
    <FileSpecRef rRef="ID_005_ZIPS">
      <Part PartVersion="English"/>
    </FileSpecRef>
  </Container>
</FileSpec>
<FileSpec Class="Parameter" Compression="Deflate"
  ID="B_ENGLISH_FILE" MimeType="application/pdf" Status="Available" URL="b.pdf">
  <Container>
    <FileSpecRef rRef="ID_005_ZIPS">
      <Part PartVersion="English"/>
    </FileSpecRef>
  </Container>
</FileSpec>
<FileSpec Class="Parameter" Compression="Deflate" ID="A_GERMAN_FILE"
  MimeType="application/pdf" Status="Available" URL="a.pdf">
  <Container>
    <FileSpecRef rRef="ID_005_ZIPS">
      <Part PartVersion="German"/>
    </FileSpecRef>
  </Container>
</FileSpec>
<FileSpec Class="Parameter" Compression="Deflate" ID="B_GERMAN_FILE"
  MimeType="application/pdf" Status="Available" URL="b.pdf">
  <Container>
    <FileSpecRef rRef="ID_005_ZIPS">
      <Part PartVersion="German"/>
    </FileSpecRef>
  </Container>
</FileSpec>

```

Example L.14: FileSpec #11.3 — the pdf is Partitioned

```

<FileSpec Class="Parameter" ID="ID_005_TAR" MimeType="Tar"
  Status="Available" URL="ftp://www.any.com/e.tar"/>
<FileSpec Class="Parameter" ID="ID_005_ZIP_C"
  MimeType="application/zip" Status="Available" URL="c.zip">
  <Container>
    <FileSpecRef rRef="ID_005_TAR"/>
  </Container>

```

```

</FileSpec>
<FileSpec Class="Parameter" ID="ID_005_ZIP_D"
  MimeType="application/zip" Status="Available" URL="d.zip">
  <Container>
    <FileSpecRef rRef="ID_005_TAR"/>
  </Container>
</FileSpec>
<FileSpec Class="Parameter" Compression="Deflate" ID="ALL_FILES"
  PartIDKeys="PartVersion DocIndex" Status="Available">
  <!-- English Files -->
  <FileSpec PartVersion="English">
    <Container>
      <FileSpecRef rRef="ID_005_ZIP_C"/>
    </Container>
    <!-- English File A -->
    <FileSpec DocIndex="1" MimeType="application/pdf" URL="a.pdf"/>
    <!-- English File B -->
    <FileSpec DocIndex="2" MimeType="application/pdf" URL="b.pdf"/>
  </FileSpec>
  <!-- German Files -->
  <FileSpec PartVersion="German">
    <Container>
      <FileSpecRef rRef="ID_005_ZIP_D"/>
    </Container>
    <!-- German File A -->
    <FileSpec DocIndex="1" MimeType="application/pdf" URL="a.pdf"/>
    <!-- German File B -->
    <FileSpec DocIndex="2" MimeType="application/pdf" URL="b.pdf"/>
  </FileSpec>
</FileSpec>

```

Example L.15: FileSpec #11.3a — the pdf is Partitioned, Different File Layout

As above, only the file layout is not reflected in the container structure. The files are intermingled.

```

<FileSpec Class="Parameter" ID="ID_005_TAR" MimeType="Tar"
  Status="Available" URL="ftp://www.any.com/e.tar"/>
<FileSpec Class="Parameter" ID="ID_005_ZIP_C"
  MimeType="application/zip" Status="Available" URL="c.zip">
  <Container>
    <FileSpecRef rRef="ID_005_TAR"/>
  </Container>
</FileSpec>
<FileSpec Class="Parameter" ID="ID_005_ZIP_D"
  MimeType="application/zip" Status="Available" URL="d.zip">
  <Container>
    <FileSpecRef rRef="ID_005_TAR"/>
  </Container>
</FileSpec>
<FileSpec Class="Parameter" Compression="Deflate" ID="ALL_FILES"
  MimeType="application/pdf" PartIDKeys="PartVersion DocIndex" Status="Available">
  <!-- English Files -->
  <FileSpec PartVersion="English">
    <!-- English File A -->
    <FileSpec DocIndex="1" URL="a.pdf">
      <Container>
        <FileSpecRef rRef="ID_005_ZIP_C"/>
      </Container>
    </FileSpec>
    <!-- English File B -->
    <FileSpec DocIndex="2" URL="a.pdf">
      <Container>
        <FileSpecRef rRef="ID_005_ZIP_D"/>
      </Container>
    </FileSpec>
  </FileSpec>
  <!-- German Files -->
  <FileSpec PartVersion="German">
    <!-- German File A -->
    <FileSpec DocIndex="1" URL="b.pdf">

```



```

    <Container>
      <FileSpecRef rRef="ID_005_ZIP_C"/>
    </Container>
  </FileSpec>
  <!-- German File B -->
  <FileSpec DocIndex="2" URL="b.pdf">
    <Container>
      <FileSpecRef rRef="ID_005_ZIP_D"/>
    </Container>
  </FileSpec>
</FileSpec>
</FileSpec>

```

Example L.16: FileSpec #11.4 – Both Partitioned

```

<FileSpec Class="Parameter" ID="ID_005_TAR" MimeType="Tar"
  Status="Available" URL="ftp://www.any.com/e.tar"/>
<FileSpec Class="Parameter" ID="ID_005_ZIPS"
  MimeType="application/zip" PartIDKeys="PartVersion" Status="Available">
  <Container>
    <FileSpecRef rRef="ID_005_TAR"/>
  </Container>
  <FileSpec PartVersion="English" URL="c.zip"/>
  <FileSpec PartVersion="German" URL="d.zip"/>
</FileSpec>
<FileSpec Class="Parameter" Compression="Deflate" ID="ALL_FILES"
  PartIDKeys="PartVersion DocIndex" Status="Available">
  <!-- English Files -->
  <FileSpec PartVersion="English">
    <Container>
      <FileSpecRef rRef="ID_005_ZIPS">
        <Part PartVersion="English"/>
      </FileSpecRef>
    </Container>
    <!-- English File A -->
    <FileSpec DocIndex="1" MimeType="application/pdf" URL="a.pdf"/>
    <!-- English File B -->
    <FileSpec DocIndex="2" MimeType="application/pdf" URL="b.pdf"/>
  </FileSpec>
  <!-- German Files -->
  <FileSpec PartVersion="German">
    <Container>
      <FileSpecRef rRef="ID_005_ZIPS">
        <Part PartVersion="German"/>
      </FileSpecRef>
    </Container>
    <!-- German File A -->
    <FileSpec DocIndex="1" MimeType="application/pdf" URL="a.pdf"/>
    <!-- German File B -->
    <FileSpec DocIndex="2" MimeType="application/pdf" URL="b.pdf"/>
  </FileSpec>
</FileSpec>

```

Example L.17: FileSpec #12

Multiple PDF and TIFF files in several zip's contained in a tar file. Use all PDF files in c.zip, using the [FileSpec/@FileFormat](#) mechanism and just Pictures/TIFS/a.pdf in d.zip. File layout looks like:

```

e.tar
c.zip
a.pdf
a.tif
b.pdf
b.tif
d.zip
PDFS/a.pdf
PDFS/b.pdf
Pictures/TIFS/a.pdf
Pictures/TIFS/b.pdf

```

```

<FileSpec Class="Parameter" ID="ID_005_TAR" MimeType="Tar"
  Status="Available" URL="ftp://www.any.com/e.tar"/>
<FileSpec Class="Parameter" ID="ID_005_ZIP_C"
  MimeType="application/zip" Status="Available" URL="c.zip">
  <Container>
    <FileSpecRef rRef="ID_005_TAR"/>
  </Container>
</FileSpec>
<FileSpec Class="Parameter" ID="ID_005_ZIP_D"
  MimeType="application/zip" Status="Available" URL="d.zip">
  <Container>
    <FileSpecRef rRef="ID_005_TAR"/>
  </Container>
</FileSpec>
<FileSpec Class="Parameter" Compression="Deflate"
  FileFormat="%s.pdf" FileTemplate="all" ID="PDF_FILES"
  MimeType="application/pdf" Status="Available">
  <Container>
    <FileSpecRef rRef="ID_005_ZIP_C"/>
  </Container>
</FileSpec>
<FileSpec Class="Parameter" Compression="Deflate" ID="Pictures"
  Status="Available" URL="Pictures/TIFS/a.pdf">
  <Container>
    <FileSpecRef rRef="ID_005_ZIP_D"/>
  </Container>
</FileSpec>

```

L.4 Example of an Intent Job Ticket with a doubly nested ZIP packaging file

The following is a complete example of an intent job ticket using [ArtDeliveryIntent](#) with a doubly nested packaging file. The example shows a myPictures.jpg file that is contained in myNestedZip.zip file which is contained in myZip.zip file:

Example L.18: Intent Job Ticket

```

<JDF ID="FileSpecProposal01" JobID="bookJob" JobPartID="bookJob-1"
  Status="Waiting" Type="Product" Version="1.6" xmlns="http://www.CIP4.org/JDFSchema_1_1">
  <ResourcePool>
    <ArtDeliveryIntent Class="Intent" ID="FileSpecProposal02" Status="Draft">
      <ArtDelivery ArtDeliveryType="DigitalMedia">
        <RunListRef rRef="FileSpecProposal05"/>
      </ArtDelivery>
    </ArtDeliveryIntent>
    <RunList Class="Parameter" ID="FileSpecProposal05" Status="Available">
      <LayoutElement>
        <FileSpec Compression="Deflate" MimeType="image/jpeg" URL="myFiles/myPicture.jpg">
          <Container>
            <FileSpecRef rRef="ID_002"/>
          </Container>
        </FileSpec>
      </LayoutElement>
    </RunList>
    <Component Amount="100" Class="Quantity"
      ComponentType="FinalProduct" DescriptiveName="FileSpec Test"
      ID="FileSpecProposal03" Status="Unavailable"/>
    <FileSpec Class="Parameter" ID="ID_001" MimeType="application/zip"
      Status="Available" URL="http://www.CIP4.org/myZip.zip"/>
    <FileSpec Class="Parameter" Compression="Deflate" ID="ID_002"
      MimeType="application/zip" Status="Available" URL="myNestedZip.zip">
      <Container>
        <FileSpecRef rRef="ID_001"/>
      </Container>
    </FileSpec>
  </ResourcePool>
  <ResourceLinkPool>
    <ComponentLink Amount="100" Usage="Output" rRef="FileSpecProposal03"/>
    <ArtDeliveryIntentLink Usage="Input" rRef="FileSpecProposal02"/>
  </ResourceLinkPool>
</JDF>

```

L.5 AppOS and OSVersion Attributes

New in JDF 1.2

This section lists example values for the following attributes of the *FileSpec* resource: *@AppOS* and *@OSVersion*. The listing is intended to be exhaustive for the most common operating systems routinely used in **JDF** applications. However, other operating systems and combinations MAY be used as well. New versions of operating systems can be used and SHOULD follow the patterns established in the following table.

Table L.2: AppOS and OSVersion Examples

APPOS	OSVERSION	DESCRIPTION
Linux	2.2	Linux operation system
Mac	10.2.4	Macintosh operation system
Solaris	4.0	Sun Solaris operation system
UNIX	BSD	Berkeley UNIX
UNIX	V	System V UNIX
UNIX	V.1	System V UNIX
UNIX	V.2	System V UNIX
UNIX	V.3	System V UNIX
UNIX	PC	UNIX for the PC
Windows	95	Windows 95
Windows	98	Windows 98
Windows	NT	Windows NT
Windows	NT-5	Windows 2000
Windows	NT-5.1	XP [not yet registered by Microsoft with IANA]

Appendix M

MReferences

Throughout this specification references to other documents are indicated by short symbolic names inside square brackets, (e.g., ▶ [ICC.1]). Implementers need to read and conform to such referenced documents when implementing a part of this specification with such a reference. The reader is directed to this appendix section to find the full title, date, source and availability of all such references.

Table M.1: References (Sheet 1 of 12)

TERM	DEFINITION
[AdsML]	<i>AdsML Framework 3.5 Release 3 - Specification & Schema</i> Date: 17 May 2004 Produced by: AdsML Technical Working Group Available at: http://www.adsml.biz
[Apache Foundation]	<i>A multitude of open source software projects</i> Date: - Produced by: The Apache Software Foundation Available at: https://projects.apache.org/projects.html
[Braille ASCII]	<i>Six dot Braille representation of the ASCII character set</i> Date: - Available at: https://en.wikipedia.org/wiki/Braille_ASCII
[Braille Unicode]	<i>Braille Patterns</i> Date: - Available at: https://en.wikipedia.org/wiki/Braille_Unicode_block
[BT.601-7]	<i>ITU Recommendation 601-7</i> <i>Studio encoding parameters of digital television for standard 4:3 and wide screen 16:9 aspect ratios.</i> Date: March 2011 Produced by: International Telecommunication Union - Radioncommunication Sector Available at: https://www.itu.int/rec/R-REC-BT.601/ International Telecommunication Union, General Secretariat — Sales Section, Place des Nations, CH-1211 Geneva 20 (Switzerland)
[CGATS.21]	<i>CGATS.21-1-2013 and CGATS.21-2-2013</i> <i>Graphic technology - Printing from digital data across multiple technologies Parts 1 & 2</i> Date: 2013 Produced by: Committee for Graphic Arts Technologies Standards (NPES serves as the American National Standards Institute (ANSI) secretariat to CGATS) Available at: http://www.npes.org/programs/standardsworkroom.aspx
[Characterization Data]	<i>CMYK Characterization Data</i> <i>Registered CMYK characterization data sets for standard printing processes.</i> Date: - Produced by: International Color Consortium Available at: http://www.color.org/chardata/drsection1.xalter
[CIE 015:2004]	<i>CIE 15:2004</i> <i>Colorimetry, 3rd Edition.</i> Date: 2004 Produced by: Commission Internationale de l'Eclairage International (CIE) Available at: http://www.cie.co.at/publications/colorimetry-3rd-edition

Table M.1: References (Sheet 2 of 12)

TERM	DEFINITION
[CIP3 - PPF]	<p><i>CIP3 Print Production Format (PPF)</i></p> <p>Date: 1 June 1998 Version: CIP3 PPF Specification 3.0 Produced by: CIP4 Organization Available at: https://confluence.cip4.org/display/PUB/PPF</p>
[ColorPS]	<p><i>Color Separation Conventions for PostScript Language Programs</i> <i>Technical Note #5044</i></p> <p>Date: 24 May 1996 Produced by: Adobe Systems Inc. Available at: https://www.adobe.com/content/dam/acom/en/devnet/postscript/pdfs/5044.ColorSep_Conv.pdf</p>
[Corrugated Packaging]	<p><i>Corrugated packaging</i></p> <p>Date: - Produced by: Corrugated Packaging Alliance Available at: http://www.corrugated.org/</p>
[DCS2.0]	<p><i>Document Color Separation (DCS), version 2.0</i></p> <p>Date: Revised May 1995 Produced by: Adobe Software Inc. Available at: http://www.npes.org/standards/Tools/DSC20Spec.pdf http://www.npes.org/standards/Tools/DCS20Spec.pdf</p>
[DDES3]	<p><i>Graphic technology - Prepress digital data exchange - Diecutting data (DDES3)</i></p> <p>Date: Revised 2017 Produced by: ANSI® IT8.6-2017 Available at: http://webstore.ansi.org.</p>
[DIN 15146-4]	<p><i>Pallets; timber four-way-flat pallets; 800mm x 600mm</i></p> <p>Date: Revised 1991 Produced by: DIN Standards Committee Packaging Available at: https://www.din.de/en.</p>
[DIN 5005]	<p><i>Paper and board - Sheets for loose leaf binders - Dimensions for standard punching for paper sizes A4 and A5</i></p> <p>Date: Edition 2008-2 Produced by: DIN Standards Committee Paper, board and pulps Available at: https://www.din.de/en.</p>
[DIN 821-3]	<p><i>Files and folders; concepts</i></p> <p>Date: Edition 1991-03 Produced by: DIN Standards Committee Timber and Furniture Available at: https://www.din.de/en.</p>
[DIN EN 13698-1]	<p><i>Pallet production specification - Part 1: Construction specification for 800mm x 1200mm flat wooden pallets</i></p> <p>Date: Edition 2004-01 Produced by: DIN Standards Committee Packaging Available at: https://www.din.de/en.</p>
[DIN EN 13698-2]	<p><i>Pallet production specification - Part 2: Construction specification for 1000mm x 1200mm flat wooden pallets</i></p> <p>Date: Revised 2009-10 Produced by: DIN Standards Committee Packaging Available at: https://www.din.de/en.</p>

Table M.1: References (Sheet 3 of 12)

TERM	DEFINITION
[ECMA]	<p><i>ECMA Code of Folding Carton Design Styles</i></p> <p>Date: -</p> <p>Produced by: European Carton Makers Association</p> <p>Available at: https://www.ecma.org/publications/ecma-code-of-folding-carton-design-styles.html</p>
[FEFCO]	<p><i>FEFCO European Federation of Corrugated Board Manufacturers</i></p> <p>Date: -</p> <p>Produced by: European Federation of Corrugated Board Manufacturers</p> <p>Available at: http://www.fefco.org</p>
[FileURL]	<p><i>CIP4 Application Note - Use of FileURL in JDF</i></p> <p>Date: August 2003</p> <p>Produced by: CIP4 Organization</p> <p>Available at: http://www.cip4.org</p>
[FINAT]	<p><i>Trade Association for the Self-Adhesive and Labeling Industry</i></p> <p>Web site: http://www.finat.com</p>
[FOGRA]	<p><i>Characterization data for standardized printing conditions</i></p> <p><i>Various Standards, e.g. FOGRA39, FOGRA47 etc</i></p> <p>Date: N/A</p> <p>Produced by: Fogra Research Institute for Media Technologies</p> <p>Available at: https://www.fogra.org/</p>
[Grammage Conversion]	<p><i>Basis Weight and Grammage Conversion Tables.</i></p> <p>Date: -</p> <p>Produced by: EDS Inc. Editorial & Design Services</p> <p>Available at: http://www.edsebooks.com/paper/grammage.html</p>
[IANA-mt]	<p><i>IANA Registry of MIME Media Types</i></p> <p>Date: 2018-02-09</p> <p>Available at: http://www.iana.org/assignments/media-types</p>
[IANA-os]	<p><i>IANA Registry of Operating System Names</i></p> <p>Available at: http://www.iana.org/assignments/operating-system-names</p>
[ICC.1]	<p><i>Specification ICC.1:2010-12 (Profile version 4.3.0.0)</i></p> <p><i>Image technology colour management - Architecture, profile format, and data structure</i></p> <p>Date: 2010</p> <p>Produced by: International Color Consortium (ICC)</p> <p>Available at: http://www.color.org/</p>
[IEEE1284]	<p><i>IEEE 1284-2000</i></p> <p><i>IEEE Standard Signaling Method for a Bidirectional Parallel Peripheral Interface for Personal Computers</i></p> <p>Date: 2000</p> <p>Produced by: IEEE</p> <p>Available at: http://standards.ieee.org/catalog/olis/busarch.html</p>
[IEEE754]	<p><i>IEEE 754-2008</i></p> <p><i>Standard for Binary Floating-Point Arithmetic</i></p> <p>Date: 2008</p> <p>Produced by: IEEE</p> <p>Available at: http://grouper.ieee.org/groups/754/</p>
[IJPEG]	<p><i>Library for JPEG image compression.</i></p> <p>Date: 14-Jan-2018</p> <p>Produced by: Independent JPEG Group</p> <p>Available at: https://www.ijpeg.org</p>

Table M.1: References (Sheet 4 of 12)

TERM	DEFINITION
[ISO/IEC 14496-22:2015]	<p>Information technology -- Coding of audio-visual objects -- Part 22: Open Font Format</p> <p>Date: 2015 Produced by: ISO Available at: https://www.iso.org/store.html</p>
[ISO/IEC 15948:2004]	<p>ISO/IEC 15948:2004</p> <p>Information technology -- Computer graphics and image processing -- Portable Network Graphics (PNG): Functional specification</p> <p>Second edition</p> <p>Date: 2004 Produced by: ISO Available at: https://www.iso.org/store.html</p>
[ISO/NP 3166-1:2013]	<p>ISO/NP 3166-1:2013</p> <p>Codes for the representation of names of countries and their subdivisions -- Part 1: Country codes.</p> <p>Date: 2013 Produced by: ISO Central Secretariat Available at: https://www.iso.org/store.html</p>
[ISO12639:2004]	<p>ISO 12639:2004</p> <p>Graphic technology - Prepress digital data exchange - Tag image file format for image technology (TIFF/IT)</p> <p>Date: 2004 Produced by: ISO Available at: https://www.iso.org/store.html</p>
[ISO12647-2:2004]	<p>ISO 12647-2:2004</p> <p>Graphic technology - Process control for the production of half-tone colour separations, proof and production prints - Part 2: Offset lithographic processes.</p> <p>Date: 2004 Produced by: ISO Available at: https://www.iso.org/store.html</p>
[ISO12647-2:2013]	<p>ISO 12647-2:2013</p> <p>Graphic technology - Process control for the production of half-tone colour separations, proof and production prints - Part 2: Offset lithographic processes.</p> <p>Date: 2013 Produced by: ISO Available at: https://www.iso.org/store.html</p>
[ISO13655:2017]	<p>ISO 13655:2017</p> <p>Graphic technology -- Spectral measurement and colorimetric computation for graphic arts images.</p> <p>Date: 2017 Produced by: ISO Available at: https://www.iso.org/store.html</p>
[ISO14977:1996]	<p>ISO 14977:1996(E)</p> <p>Information technology -- Syntactic metalanguage -- Extended BNF</p> <p>Date: 1996 Produced by: ISO Available at: https://www.iso.org/store.html</p>
[ISO15930-1:2001]	<p>ISO 15930-1:2001</p> <p>Graphic technology - Prepress digital data exchange - Use of PDF - Part 1: Complete exchange using CMYK data (PDF/X-1 and PDF/X-1a).</p> <p>Date: 2001 Produced by: ISO Available at: https://www.iso.org/store.html</p>

Table M.1: References (Sheet 5 of 12)

TERM	DEFINITION
[ISO15930-3:2002]	<p>ISO 15930-3:2002</p> <p>Graphic technology — Prepress digital data exchange — Use of PDF — Part 3: Complete exchange suitable for colour-managed workflows (PDF/X-3).</p> <p>Date: 2002</p> <p>Produced by: ISO</p> <p>Available at: https://www.iso.org/store.html</p>
[ISO15930-6:2003]	<p>ISO 15930-6:2003</p> <p>Graphic technology — Prepress digital data exchange — Use of PDF — Part 6: Complete exchange suitable for colour-managed workflows using PDF 1.4 (PDF/X-3).</p> <p>Date: 2003</p> <p>Produced by: ISO</p> <p>Available at: https://www.iso.org/store.html</p>
[ISO15930-7:2010]	<p>ISO 15930-7:2010</p> <p>Graphic technology — Prepress digital data exchange — Use of PDF — Part 7: Complete exchange of printing data (PDF/X-4) and partial exchange of printing data with external profile reference (PDF/X-4p) using PDF 1.6.</p> <p>Date: 2010</p> <p>Produced by: ISO</p> <p>Available at: https://www.iso.org/store.html</p>
[ISO15930-8:2010]	<p>ISO 15930-8:2010</p> <p>Graphic technology — Prepress digital data exchange using PDF — Part 8: Partial exchange of printing data using PDF 1.6 (PDF/X-5).</p> <p>Date: 2010</p> <p>Produced by: ISO</p> <p>Available at: https://www.iso.org/store.html</p>
[ISO17972-1:2015]	<p>ISO 17972-1:2015</p> <p>Graphic technology -- Colour data exchange format -- Part 1: Relationship to CxF3 (CxF/X)</p> <p>Date: 2015</p> <p>Produced by: ISO</p> <p>Available at: https://www.iso.org/store.html</p>
[ISO19593-1:2016]	<p>ISO 19593-1:2016</p> <p>Graphic technology -- Use of PDF to associate processing steps and content data -- Part 1: Processing steps for packaging and labels</p> <p>Date: 2016</p> <p>Produced by: ISO</p> <p>Available at: https://www.iso.org/store.html</p>
[ISO2108:2017]	<p>ISO 2108:2017</p> <p>Information and documentation -- International standard book number (ISBN).</p> <p>Date: 2017</p> <p>Produced by: ISO</p> <p>Available at: https://www.iso.org/store.html</p>
[ISO216:2007]	<p>ISO 216:2007</p> <p>Writing paper and certain classes of printed matter -- Trimmed sizes -- A and B series.</p> <p>Date: 1975</p> <p>Produced by: ISO</p> <p>Available at: https://www.iso.org/store.html</p>
[ISO2470-1:2016]	<p>ISO 2470-1:2016</p> <p>Paper, board and pulps -- Measurement of diffuse blue reflectance factor -- Part 1: Indoor daylight conditions (ISO brightness).</p> <p>Date: 2016</p> <p>Produced by: ISO</p> <p>Available at: https://www.iso.org/store.html</p>

Table M.1: References (Sheet 6 of 12)

TERM	DEFINITION
[ISO2471:2008]	<p>ISO 2471:2008 <i>Paper and board—Determination of opacity (paper backing)—Diffuse reflectance method.</i> Date: 2008 Produced by: ISO Available at: https://www.iso.org/store.html</p>
[ISO5-3:2009]	<p>ISO 5-3:1995 <i>Photography and graphic technology -- Density measurements -- Part 3: Spectral conditions.</i> Date: 2009 Produced by: ISO Available at: https://www.iso.org/store.html</p>
[ISO5-4:2009]	<p>ISO 5-4:1995 <i>Photography and graphic technology -- Density measurements -- Part 4: Geometric conditions for reflection density.</i> Date: 2009 Produced by: ISO Available at: https://www.iso.org/store.html</p>
[ISO8254-1:2009]	<p>ISO 8254-1:2009 <i>Paper and board -- Measurement of specular gloss -- Part 1: 75 degree gloss with a converging beam, TAPPI method</i> Date: 2009 Produced by: ISO Available at: https://www.iso.org/store.html</p>
[ISO838]	<p><i>Paper; Holes for general filing purposes; Specifications</i> Date: 1974 Produced by: ISO Available at: https://www.iso.org/store.html</p>
[ISO8601:2004]	<p>ISO 8601:2004 <i>Data elements and interchange formats - Information interchange - Representation of dates and times.</i> Date: 2004 Produced by: ISO Available at: https://www.iso.org/store.html</p>
[japancolor]	<p><i>Japan Color 2001</i> Date: 2001 Produced by: Japan Printing Machinery Manufacturers Association, Office of JNC for TC130 Available at: http://japancolor.jp/about/about.html</p>
[Japanese Paper Sizes]	<p><i>Japanese Papers for Printing, Metric Measurements and Inch Equivalents.</i> Date: - Produced by: EDS Inc. Editorial & Design Services Available at: http://www.edsebooks.com/paper/jpaper.html</p>
[Java Keytool]	<p><i>Keytool - Key and Certificate Management Tool</i> Date: - Produced by: Oracle Available at: https://docs.oracle.com/javase/1.5.0/docs/tooldocs/windows/keytool.html</p>
[JIS P0138]	<p>JIS P 0138:1998 <i>Writing paper and certain classes of printed matter -- Trimmed sizes -- A and B series.</i> Date: 1998 Produced by: JIS Available at: https://webdesk.jisa.or.jp/books/W11M0010</p>

Table M.1: References (Sheet 7 of 12)

TERM	DEFINITION
[K&R]	<p><i>The C Programming Language</i> , by Brian W. Kernighan and Dennis M. Ritchie <i>Second Edition</i></p> <p>Date: March 22, 1988 Produced by: Prentice Hall Available at: Book only - ISBN 0131103628</p>
[macbinary]	<p><i>Macintosh Binary Transfer Format ("MacBinary II") Standard Proposal.</i></p> <p>Date: December 1996 Produced by: Macintosh Internet Developer Association Available at: http://files.stairways.com/other/macbinaryii-standard-info.txt</p>
[PDF1.6]	<p><i>PDF reference : Adobe portable document format version 1.6</i></p> <p>Date: November 2004 Produced by: Adobe Systems Incorporated Available at: https://www.adobe.com/devnet/pdf/pdf_reference_archive.html</p>
[PJTF]	<p><i>The Portable Job Ticket Format</i> <i>Version 1.1</i></p> <p>Date: 2 April 1999 Produced by: Adobe Systems Incorporated Available at: https://reference.pdfta.org/jso/32000/wp-content/uploads/2017/06/5620.PortableJobTicket.pdf</p>
[PostScript]	<p><i>PostScript Language Reference (Redbook)</i> <i>Third Edition</i></p> <p>Date: - Produced by: Adobe Systems Incorporated Available at: https://www.adobe.com/content/dam/acom/en/devnet/actionscript/articles/PLRM.pdf</p>
[PPD]	<p><i>Adobe PostScript Printer Description File Format Specification</i> <i>Version 4.3</i></p> <p>Date: 9 February 1996 Produced by: Adobe Systems Inc. Available at: https://www-cdf.fnal.gov/offline/PostScript/5003.PPD_Spec_v4.3.pdf</p>
[PPML]	<p>PPML] Personal Print Markup Language (PPML) <i>Version 2.1</i></p> <p>Date: - Produced by: Print On Demand Initiative (PODi) Available at: http://www.podi.org</p>
[PrintTalk]	<p><i>PrintTalk Implementation</i> <i>Version 1.5</i></p> <p>Date: 2015 Produced by: CIP4 Available at: https://confluence.cip4.org/display/PUB/PrintTalk</p>
[Pro Carton Fact File]	<p><i>European Association of Carton and Cartonboard manufacturers.</i> <i>Fact File</i></p> <p>Date: - Produced by: Pro Carton Available at: http://www.procarton.com/publications-news/publications/?publication_type=fact-file</p>
[Pro Carton]	<p><i>European Association of Carton and Cartonboard manufacturers.</i></p> <p>Date: - Produced by: Pro Carton Available at: http://www.procarton.com/publications-news/publications/</p>

Table M.1: References (Sheet 8 of 12)

TERM	DEFINITION
[PWGMAP]	<p>Mapping CIP4 JDF to PWG Print Job Ticket v1.0 (JDFMAP)</p> <p>Date: August 2017</p> <p>Produced by: The Printer Working Group</p> <p>Available at: http://ftp.pwg.org/pub/pwg/informational/bp-smjdfmap10-20170828.pdf</p>
[Quark]	<p>See http://www.quark.com.</p>
[RFC1738]	<p>RFC 1738</p> <p>Uniform Resource Locators (URL)</p> <p>Date: 1994</p> <p>Produced by: Internet Engineering Task Force (IETF), Network Working Group</p> <p>Available at: http://www.rfc-editor.org/rfcsearch.html</p> <p>Note: This version is obsolete and has been replaced by:</p> <p>RFC 4248, The telnet URI Scheme - 2005</p> <p>RFC 4266, The gopher URI Scheme - 2005</p>
[RFC1741]	<p>RFC 1741</p> <p>MIME Content Type for BinHex Encoded Files, by Faltstrom, P., Crocker, D. and Fair, E.</p> <p>Date: December 1994</p> <p>Produced by: Internet Engineering Task Force (IETF), Network Working Group</p> <p>Available at: http://www.rfc-editor.org/rfcsearch.html</p>
[RFC1950]	<p>RFC 1950</p> <p>ZLIB Compressed Data Format Specification version 3.3, by P. Deutsch.</p> <p>Date: May 1996</p> <p>Produced by: Internet Engineering Task Force (IETF), Network Working Group</p> <p>Available at: http://www.rfc-editor.org/rfcsearch.html</p>
[RFC1951]	<p>RFC 1951</p> <p>DEFLATE Compressed Data Format Specification version 1.3, by Deutsch, P.</p> <p>Date: May 1996</p> <p>Produced by: Internet Engineering Task Force (IETF), Network Working Group</p> <p>Available at: http://www.rfc-editor.org/rfcsearch.html</p>
[RFC1952]	<p>RFC 1952</p> <p>GZIP file format specification version 4.3, by Deutsch, P.</p> <p>Date: May 1996</p> <p>Produced by: Internet Engineering Task Force (IETF), Network Working Group</p> <p>Available at: http://www.rfc-editor.org/rfcsearch.html</p>
[RFC1977]	<p>RFC 1977</p> <p>PPP BSD Compression Protocol, by Schryver, V.</p> <p>Date: May 1996</p> <p>Produced by: Internet Engineering Task Force (IETF), Network Working Group</p> <p>Available at: http://www.rfc-editor.org/rfcsearch.html</p>
[RFC2045]	<p>RFC 2045</p> <p>Multipurpose Internet Mail Extensions (MIME) Part One: Format of Internet Message Bodies, by Freed, N. and Borenstein, N. (Updated by RFC2231, RFC6532)</p> <p>Date: November 1996</p> <p>Produced by: Internet Engineering Task Force (IETF), Network Working Group</p> <p>Available at: http://www.rfc-editor.org/rfcsearch.html</p>
[RFC2046]	<p>RFC 2046</p> <p>Multipurpose Internet Mail Extensions (MIME) Part Two: Media Types, by Freed, N. and Borenstein, N. (Updated by RFC2646)</p> <p>Date: November 1996</p> <p>Produced by: Internet Engineering Task Force (IETF), Network Working Group</p> <p>Available at: http://www.rfc-editor.org/rfcsearch.html</p>

Table M.1: References (Sheet 9 of 12)

TERM	DEFINITION
[RFC2231]	<p>RFC 2231 <i>MIME Parameter Value and Encoded Word Extensions: Character Sets, Languages, and Continuations</i> Date: November 1997 Produced by: Internet Engineering Task Force (IETF), Network Working Group Available at: http://www.rfc-editor.org/rfcsearch.html</p>
[RFC2387]	<p>RFC 2387 <i>The MIME Multipart/Related Content-type</i>, by Levinson, E. Date: August 1998 Produced by: Internet Engineering Task Force (IETF), Network Working Group Available at: http://www.rfc-editor.org/rfcsearch.html</p>
[RFC2392]	<p>RFC 2392 <i>Content-ID and Message-ID Uniform Resource Locators</i>, by Levinson, E. Date: August 1998 Produced by: Internet Engineering Task Force (IETF), Network Working Group Available at: http://www.rfc-editor.org/rfcsearch.html</p>
[RFC2616]	<p>RFC 2616 <i>Hypertext Transfer Protocol – HTTP/1.1</i> Date: June 1999 Produced by: Internet Engineering Task Force (IETF), Network Working Group Available at: http://www.rfc-editor.org/rfcsearch.html</p>
[RFC3066]	<p>RFC 3066 <i>Tags for the Identification of Languages</i>, by H. Alvestrand. Date: January 2001 Produced by: Internet Engineering Task Force (IETF), Network Working Group Available at: http://www.rfc-editor.org/rfcsearch.html</p>
[RFC3302]	<p>RFC 3302 <i>Tag Image File Format (TIFF) – image/tiff MIME Sub-type Registration</i>, by Parsons, G., Rafferty, J. Date: September 2002 Produced by: Internet Engineering Task Force (IETF), Network Working Group Available at: http://www.rfc-editor.org/rfcsearch.html</p>
[RFC3805]	<p>RFC 3805 <i>Printer MIB v2</i> Date: June 2004 Produced by: Internet Engineering Task Force (IETF), Network Working Group Available at: http://www.rfc-editor.org/rfcsearch.html</p>
[RFC3806]	<p><i>Printer Finishing MIB</i> Date: June 2004 Produced by: Internet Engineering Task Force (IETF), Network Working Group Available at: http://www.rfc-editor.org/rfcsearch.html</p>
[RFC3966]	<p>RFC 3966 <i>The tel URI for Telephone Numbers</i> by H. Schulzrinne Date: December 2004 Produced by: Internet Engineering Task Force (IETF), Network Working Group Available at: http://www.rfc-editor.org/rfcsearch.html</p>
[RFC3986]	<p>RFC 3986 <i>Uniform Resource Identifier (URI): Generic Syntax</i> by T. Berners-Lee, R. Fielding and L. Masinter Date: January 2005 Produced by: Internet Engineering Task Force (IETF), Network Working Group Available at: http://www.rfc-editor.org/rfcsearch.html</p>

Table M.1: References (Sheet 10 of 12)

TERM	DEFINITION
[RFC3987]	<p>RFC 3987 <i>Internationalized Resource Identifiers (IRIs)</i>, by M. Duerst and M. Suignard Date: January 2005 Produced by: Internet Engineering Task Force (IETF), Network Working Group Available at: http://www.rfc-editor.org/rfcsearch.html</p>
[RFC4648]	<p>RFC 4648 <i>The Base16, Base32, and Base64 Data Encodings</i>, by S. Josefsson Date: October 2006 Produced by: Internet Engineering Task Force (IETF), Network Working Group Available at: http://www.rfc-editor.org/rfcsearch.html</p>
[RFC5322]	<p>RFC 5322 <i>Internet Message Format</i> Date: October 2008 Produced by: Internet Engineering Task Force (IETF), Network Working Group Available at: http://www.rfc-editor.org/rfcsearch.html</p>
[RFC6068]	<p>RFC 6068 <i>The mailto URL scheme</i> Date: October 2010 Produced by: Internet Engineering Task Force (IETF), Network Working Group Available at: http://www.rfc-editor.org/rfcsearch.html</p>
[RFC6101]	<p>RFC 6101 (Category: Historic) <i>The Secure Sockets Layer (SSL) Protocol Version 3.0</i>, by A. Freier, P. Karlton and P. Kocher Date: August 2011 Produced by: Internet Engineering Task Force (IETF), Network Working Group Available at: http://www.rfc-editor.org/rfcsearch.html</p>
[RSA Labs]	<p>RSA Security Date: - Produced by: RSA Labs Available at: https://www.rsa.com/en-us/research-and-thought-leadership/rsa-labs</p>
[SSL3]	<p>SSL Specification Freesoft, SSL Specification 3.0 Date: - Produced by: - Available at: http://www.freesoft.org/CIE/Topics/ssl-draft/3-SPEC.HTM Note: Refer to ▶ [RFC6101]</p>
[TAPPI T480]	<p>TAPPI T480 <i>Specular Gloss of Paper and Paperboard at 75 Degrees, Test Method T 480 om-15</i> Date: December 2009 Produced by: TAPPI Available at: http://www.tappi.org</p>
[TAPPI T519]	<p>TAPPI T519 <i>Diffuse Opacity of Paper (d/o paper backing), Test Method T 519 om-17</i> Date: December 2009 Produced by: TAPPI Available at: http://www.tappi.org</p>
[TAPPI T527]	<p>TAPPI T527 <i>Color of Paper and Paperboard (d/o, C/2), Test Method T 527 om-02</i> Date: - Produced by: TAPPI Available at: http://www.tappi.org</p>

Table M.1: References (Sheet 11 of 12)

TERM	DEFINITION
[TAPPI T560]	<p>TAPPI T560 <i>CIE whiteness and tint of paper and paperboard (d/o geometry, C/2 illuminant/observer), Test Method T 560 om-10</i></p> <p>Date: December 2009 Produced by: TAPPI Available at: http://www.tappi.org</p>
[TIFF6]	<p>TIFF Revision 6.0</p> <p>Date: June 1992 Produced by: Adobe Systems Incorporated Available at: https://www.loc.gov/preservation/digital/formats/fdd/fdd000022.shtml#notes</p>
[TIFFPS]	<p>Adobe Photoshop TIFF Technical Notes</p> <p>Date: March 2002 Produced by: Adobe Systems Incorporated Available at: https://www.loc.gov/preservation/digital/formats/fdd/fdd000022.shtml#notes</p>
[TrueTypeFont]	<p>TrueType font file and TrueType Open specification</p> <p>Date: August 1995 Produced by: Microsoft Corporation Available at: http://www.microsoft.com/typography/specs/</p>
[type1font]	<p>Adobe Type 1 Font Format Adobe Systems, Inc.</p> <p>Date: 1990 Produced by: Addison-Wesley Publishing Company, Inc. Available at: https://www-cdf.fnal.gov/offline/PostScript/T1_SPEC.PDF</p>
[Unicode5.0.0]	<p>The Unicode Standard, Version 5.0,</p> <p>Date: July, 2006 Produced by: The Unicode Consortium Available at: https://www.unicode.org/</p>
[UPNP]	<p>Printer Device and Printer Basic Service Version 1.0</p> <p>Date: 2002 Produced by: Universal Plug N Play Forum Available at: https://openconnectivity.org/developer/specifications/upnp-resources/upnp/printer-device-v-1-0-and-printer-basic-service-v-1-0</p>
[URI]	<p>URIs, URLs, and URNs: Clarifications and Recommendations 1.0</p> <p>Date: 21 September 2001 Produced by: World Wide Web Consortium (W3C) Available at: https://www.w3.org/TR/uri-clarification/</p>
[uuencode]	<p>Unix Uuencode, The Single UNIX ® Specification, Version 2 (Converts binary into the local character set that is suitable to pass through email systems.)</p> <p>Date: 1997 Produced by: The Open Group Available at: http://www.opengroup.org/onlinepubs/007908799/xcu/uuencode.html</p>
[vCard]	<p>Standard file format for electronic business cards.</p> <p>Date: N/A Produced by: Versit Consortium Refer to : https://en.wikipedia.org/wiki/VCard</p>

Table M.1: References (Sheet 12 of 12)

TERM	DEFINITION
[X.509]	<p><i>Public-Key Infrastructure (X.509) (pkix)</i> Version 1.1</p> <p>Date: 14 February 2008 Produced by: IETF. Available at: https://datatracker.ietf.org/wg/pkix/about/</p>
[XJDF]	<p><i>Exchange Job Definition Format</i> Version 2.0</p> <p>Date: January 2018 Produced by: International Cooperation for the Integration of Processes in Prepress, Press and Postpress (CIP4) Available at: http://www.cip4.org</p>
[XML Tutorial]	<p><i>Extensible Markup Language Tutorials and Guides</i></p> <p>Date: - Produced by: XMLFiles Available at: https://www.xmlfiles.com/</p>
[XML]	<p><i>Extensible Markup Language (XML) 1.0 (Fifth Edition)</i> Version (W3C Recommendation of 26 November 2008)</p> <p>Date: 26 November 2008 Produced by: World Wide Web Consortium (W3C) Available at: http://www.w3.org/TR/2008/REC-xml-20081126/</p>
[XMLNS]	<p><i>Namespaces in XML 1.0 (Third Edition)</i> Version (W3C Recommendation of 8 December 2009)</p> <p>Date: 8 December 2009 Produced by: World Wide Web Consortium (W3C) Available at: http://www.w3.org/TR/2009/REC-xml-names-20091208/</p>
[XMLSchema Status]	<p><i>XML Schema 1.1 Status</i></p> <p>Date: 28 October 2004 Produced by: World Wide Web Consortium (W3C) XML Schema working group Available at: https://www.w3.org/XML/Schema</p>
[XMLSchema]	<p><i>XML Schema Part 0+1+2: Primer, Structures and Datatypes</i> Version (W3C Recommendation of 28 Oct 2004)</p> <p>Date: 28 October 2004 Produced by: World Wide Web Consortium (W3C) XML Schema working group Available at: http://www.w3.org/TR/xmlschema-0/ http://www.w3.org/TR/xmlschema-1/ http://www.w3.org/TR/xmlschema-2/</p>
[XPath]	<p><i>XML Path Language (XPath) 2.0 (Second Edition)</i> Version W3C Recommendation 14 December 2010</p> <p>Date: 14 December 2010 Produced by: World Wide Web Consortium (W3C) Available at: https://www.w3.org/TR/xpath20/</p>

Appendix N

N Release Notes

This appendix contains a brief summary of items that have been changed in **JDF 1.6**. Refer to previous versions of the **JDF** specification for a complete history of changes.

Table N.1: Release notes for JDF 1.6 (Sheet 1 of 9)

ITEM	ACTION	DESCRIPTION	LOCATION
date	Deprecated	Removed data type.	▶ Table 1.6 JDF Data Types.
gYearMonth	Deprecated	Removed data type.	▶ Table 1.6 JDF Data Types.
TimeRange	Deprecated	Removed data type.	▶ Table 1.6 JDF Data Types.
RelatedProjectID	New	Added attribute to JDF .	▶ Table 3.4 JDF.
RelatedProjectID	New	Added attribute to Ancestor .	▶ Table 3.6 Ancestor Element.
PipePartIDKeys	Deprecated	Removed from ResourceLink .	▶ Table 3.14 ResourceLink Element.
ProcessUsage	Modified		▶ Table 3.14 ResourceLink Element.
Lot	Deprecated	Removed from ResourceLink .	▶ Table 3.14 ResourceLink Element.
Lot	Deprecated	Removed from PartAmount .	▶ Table 3.16 PartAmount Element.
Lot	Deprecated	Removed element.	▶ Section 3.9.4.0.1 Lot.
PartIDKeys	Modified	New partition keys added.	▶ Table 3.21 Partitionable Resource Element.
LotID	New	Added attribute to Part .	▶ Table 3.23 Part Element.
PrintConditio	New	Added attribute to Part .	▶ Table 3.23 Part Element.
Languages	New	Added attribute to Subscription .	▶ Table 5.11 Subscription Element.
MaxQueueSize	New	Added attribute to Queue .	▶ Table 5.23 Queue Element.
QueueSize	Modified	Clarified description.	▶ Table 5.23 Queue Element.
GangSource	New	Added attribute to QueueEntry .	▶ Table 5.24 QueueEntry Element.
FirstEntry	New	Added attribute to QueueFilter .	▶ Table 5.26 QueueFilter Element.
LastEntry	New	Added attribute to QueueFilter .	▶ Table 5.26 QueueFilter Element.
MaxPriority	New	Added attribute to QueueFilter .	▶ Table 5.26 QueueFilter Element.
MinPrority	New	Added attribute to QueueFilter .	▶ Table 5.26 QueueFilter Element.
GangSource	New	Added element to QueueFilter .	▶ Table 5.26 QueueFilter Element.
Policy	New	Added attribute to GangCmdFilter .	▶ Table 5.39 GangCmdFilter Element.
Amount	New	Added attribute to GangInfo .	▶ Table 5.42 GangInfo Element.
Context	Deprecated	Removed from ResourceQuParams .	▶ Table 5.82 ResourceQuParams Element.
LotDetails	Deprecated	Removed from ResourceQuParams .	▶ Table 5.82 ResourceQuParams Element.
LotID	Deprecated	Removed from ResourceQuParams .	▶ Table 5.82 ResourceQuParams Element.

Table N.1: Release notes for JDF 1.6 (Sheet 2 of 9)

ITEM	ACTION	DESCRIPTION	LOCATION
<i>ProcessUsage</i>	Modified	Modified in <i>ResourceQuParams</i> .	▶ Table 5.82 ResourceQuParams Element.
<i>Activation</i>	Modified	<i>ResourceCmdParams</i> - new values.	▶ Table 5.84 ResourceCmdParams Element.
<i>Level</i>	Modified	Modified in <i>ResourceInfo</i> .	▶ Table 5.85 ResourceInfo Element.
<i>Full</i>	New	Value in <i>ResourceInfo/@Level</i> .	▶ Table 5.85 ResourceInfo Element.
<i>High</i>	New	Value in <i>ResourceInfo/@Level</i> .	▶ Table 5.85 ResourceInfo Element.
<i>Speed</i>	New	New attribute in <i>ResourceInfo</i> .	▶ Table 5.85 ResourceInfo Element.
<i>TotalAmount</i>	New	New attribute in <i>ResourceInfo</i> .	▶ Table 5.85 ResourceInfo Element.
<i>Transformation</i>	New	New attribute in <i>ResourceInfo</i> .	▶ Table 5.85 ResourceInfo Element.
<i>Lot</i>	Deprecated	Removed from <i>ResourceInfo</i> .	▶ Table 5.85 ResourceInfo Element.
<i>Queue</i>	Deprecated	Removed from <i>Status</i> .	▶ Table 5.101 Status Message.
<i>QueueInfo</i>	Deprecated	Removed from <i>StatusQuParams</i> .	▶ Table 5.102 StatusQuParams Element.
<i>GangSource</i>	New	Added to <i>JobPhase</i> .	▶ Table 5.104 JobPhase Element.
<i>ColorPool</i>	New	Added to ▶ Process Template.	▶ Template for Input Resources.
<i>Component (Wrapper)</i>	New	Input to <i>Wrapping</i> .	▶ Wrapping – Input Resources.
<i>Media</i>	Deprecate	Input to <i>Wrapping</i> .	▶ Wrapping – Input Resources.
<i>MiscConsumable (Wrapper)</i>	New	Input to <i>Wrapping</i> .	▶ Wrapping – Input Resources.
<i>VariableIntent</i>	New	Added to ▶ Product Intent Descriptions.	▶ Product Intent – Input Resources.
<i>BindingLength</i>	Deprecated	Removed from <i>BindingIntent</i> .	▶ Table 7.20 BindingIntent Resource.
<i>AdhesiveNote</i>	New	Added to <i>BindingIntent</i> .	▶ Table 7.20 BindingIntent Resource.
<i>AdhesiveNote</i>	New	New subelement.	▶ Table 7.21 AdhesiveNote Element.
<i>HoleType</i>	New	Added to <i>BindingIntent/CoilBinding</i> .	▶ Table 7.25 CoilBinding Element.
<i>HoleType</i>	New	Added to <i>BindingIntent/PlasticCombBinding</i> .	▶ Table 7.28 PlasticCombBinding Element.
<i>StapleShape</i>	New	Added to <i>BindingIntent/SaddleStitching</i> .	▶ Table 7.30 SaddleStitching Element.
<i>StapleShape</i>	New	Added to <i>BindingIntent/SideStitching</i> .	▶ Table 7.32 SideStitching Element.
<i>HoleType</i>	New	Added to <i>BindingIntent/StripBinding</i> .	▶ Table 7.34 StripBinding Element.
<i>WireCombShape</i>	New	Added to <i>BindingIntent/WireCombBinding</i> .	▶ Table 7.39 WireCombBinding Element.
<i>SingleCalendar</i>	New	Added to <i>BindingIntent/WireCombBinding/WireCombShape</i> .	▶ Table 7.39 WireCombBinding Element.
<i>TwinCalendar</i>	New	Added to <i>BindingIntent/WireCombBinding/WireCombShape</i> .	▶ Table 7.39 WireCombBinding Element.
<i>HoleType</i>	New	Added to <i>BindingIntent/WireCombBinding</i> .	▶ Table 7.39 WireCombBinding Element.

Table N.1: Release notes for JDF 1.6 (Sheet 3 of 9)

ITEM	ACTION	DESCRIPTION	LOCATION
FileSpec (DeliveryContents)	New	Added to DeliveryIntent .	▶ Table 7.43 DeliveryIntent Resource.
FileSpec (DeliveryContents)	New	Added to DeliveryIntent/DropIntent .	▶ Table 7.44 DropIntent Element.
Separation	New	Added to EmbossingIntent/EmbossingItem .	▶ Table 7.47 EmbossingItem Element.
ToolName	New	Added to EmbossingIntent/EmbossingItem .	▶ Table 7.47 EmbossingItem Element.
FoldingDetails	New	Added to FoldingIntent .	▶ Table 7.48 FoldingIntent Resource.
Orientation	New	Added to FoldingIntent .	▶ Table 7.48 FoldingIntent Resource.
Orientation	New	Added to LayoutIntent .	▶ Table 7.54 LayoutIntent Resource.
SpreadType	New	Added to LayoutIntent .	▶ Table 7.54 LayoutIntent Resource.
Grade	Deprecated	Removed from MediaIntent .	▶ Table 7.55 MediaIntent Resource.
UserMediaType	Deprecated	Removed from MediaIntent .	▶ Table 7.55 MediaIntent Resource.
Certification	New	Added to MediaIntent .	▶ Table 7.55 MediaIntent Resource.
PreflightItem	New	Added to ProofingIntent .	▶ Table 7.58 ProofingIntent Resource.
PreflightItem	New	New subelement.	▶ Table 7.59 PreflightItem Element.
CutDepth	New	Added to ShapeCuttingIntent/ShapeCut .	▶ Table 7.63 ShapeCuttingIntent Resource.
ShapeTypeDetails	New	Added to ShapeCuttingIntent/ShapeCut .	▶ Table 7.63 ShapeCuttingIntent Resource.
VariableIntent	New	New intent element.	▶ Table 7.65 VariableIntent Element.
Bottling	New	Added to BinderySignature .	▶ Table 8.10 BinderySignature Resource.
BottleAngle	Deprecated	Removed from BinderySignature/SignatureCell .	▶ Table 8.11 SignatureCell Element.
BottleAxis	Deprecated	Removed from BinderySignature/SignatureCell .	▶ Table 8.11 SignatureCell Element.
BoxType	New	Added to BoxPackingParams .	▶ Table 8.17 BoxPackingParams Resource.
BoxTypeDetails	New	Added to BoxPackingParams .	▶ Table 8.17 BoxPackingParams Resource.
Booklet	New	Added to Component/@ProductType .	▶ Table 8.45 ProductType Attribute Values.
CoverLetter	New	Added to Component/@ProductType .	▶ Table 8.45 ProductType Attribute Values.
Envelope	New	Added to Component/@ProductType .	▶ Table 8.45 ProductType Attribute Values.
Leaflet	New	Added to Component/@ProductType .	▶ Table 8.45 ProductType Attribute Values.
Letter	New	Added to Component/@ProductType .	▶ Table 8.45 ProductType Attribute Values.
Map	New	Added to Component/@ProductType .	▶ Table 8.45 ProductType Attribute Values.
Media	New	Added to Component/@ProductType .	▶ Table 8.45 ProductType Attribute Values.
Notebook	New	Added to Component/@ProductType .	▶ Table 8.45 ProductType Attribute Values.
Postcard	New	Added to Component/@ProductType .	▶ Table 8.45 ProductType Attribute Values.

Table N.1: Release notes for JDF 1.6 (Sheet 4 of 9)

ITEM	ACTION	DESCRIPTION	LOCATION
Proof	New	Added to Component / @ProductType .	▶ Table 8.45 ProductType Attribute Values.
ResponseCard	New	Added to Component / @ProductType .	▶ Table 8.45 ProductType Attribute Values.
Section	New	Added to Component / @ProductType .	▶ Table 8.45 ProductType Attribute Values.
SelfMailer	New	Added to Component / @ProductType .	▶ Table 8.45 ProductType Attribute Values.
Spine	New	Added to Component / @ProductType .	▶ Table 8.45 ProductType Attribute Values.
WrapAroundCover	New	Added to Component / @ProductType .	▶ Table 8.45 ProductType Attribute Values.
CatalogDetails	Deprecated	Removed from ContentList / ContentData .	▶ Table 8.51 ContentData Element.
CatalogID	Deprecated	Removed from ContentList / ContentData .	▶ Table 8.51 ContentData Element.
OCGControl	New	Added to ContentList / ContentData .	▶ Table 8.51 ContentData Element.
ISBN	New	Added to Content / ContentMetadata .	▶ Table 8.52 ContentMetadata Element.
ISBN10	Deprecated	Removed from Content / ContentMetadata .	▶ Table 8.52 ContentMetadata Element.
ISBN13	Deprecated	Removed from Content / ContentMetadata .	▶ Table 8.52 ContentMetadata Element.
FileSpec (DeliveryContents)	New	Added to DeliveryParams .	▶ Table 8.65 DeliveryParams Resource.
FileSpec (DeliveryContents)	New	Added to DeliveryParams / Drop .	▶ Table 8.66 Drop Element.
Unit	Deprecated	Removed from DeliveryParams / DropItem .	▶ Table 8.67 DropItem Element.
Revision	New	Added to Device .	▶ Table 8.69 Device Resource.
Revision	New	Added to Device / Module .	▶ Table 8.72 Module Element.
CutLines	New	Added to DieLayout .	▶ Table 8.73 DieLayout Resource.
Disjointing	Deprecated	Removed from DigitalPrintingParams .	▶ Table 8.80 DigitalPrintingParams Resource.
Face	New	Added to EmbossingParams / Emboss .	▶ Table 8.83 Emboss Element.
AppOS	Deprecated	Removed from FileSpec .	▶ Table 8.93 FileSpec Resource.
OSVersion	Deprecated	Removed from FileSpec .	▶ Table 8.93 FileSpec Resource.
FoldingDetails	New	Added to FoldingParams .	▶ Table 8.97 FoldingParams Resource.
Disjointing	Deprecated	Removed from GatheringParams .	▶ Table 8.100 GatheringParams Resource.
SourceCS	Deprecated	Removed from ImageCompressionParams / DCTParams .	▶ Table 8.117 DCTParams Element.
CTM	Deprecated	Removed from LabelingParams .	▶ Table 8.138 LabelingParams Resource.
Offset	New	Added to LabelingParams .	▶ Table 8.138 LabelingParams Resource.
BackISOPaperSubstrate	New	Added to Media .	▶ Table 8.173 Media Resource.

Table N.1: Release notes for JDF 1.6 (Sheet 5 of 9)

ITEM	ACTION	DESCRIPTION	LOCATION
<i>Grade</i>	Deprecated	Removed from <i>Media</i> .	▶ Table 8.173 Media Resource.
<i>Texture</i>	Modified	Values added to enumeration.	▶ Table 8.173 Media Resource.
<i>Certification</i>	New	Added to <i>Media</i> .	▶ Table 8.173 Media Resource.
<i>Color</i>	New	Added to <i>MiscConsumable</i> .	▶ Table 8.176 MiscConsumable Resource.
<i>ColorDetails</i>	New	Added to <i>MiscConsumable</i> .	▶ Table 8.176 MiscConsumable Resource.
<i>TypeDetails</i>	New	Added to <i>MiscConsumable</i> .	▶ Table 8.176 MiscConsumable Resource.
<i>BackReinforcement</i>	New	Added to <i>MiscConsumable/@ConsumableType</i> .	▶ Table 8.177 ConsumableType Attribute Values.
<i>Grommet</i>	New	Added to <i>MiscConsumable/@ConsumableType</i> .	▶ Table 8.177 ConsumableType Attribute Values.
<i>Hardener</i>	New	Added to <i>MiscConsumable/@ConsumableType</i> .	▶ Table 8.177 ConsumableType Attribute Values.
<i>Paperclips</i>	Deprecated	Removed from <i>MiscConsumable/@ConsumableType</i> .	▶ Table 8.177 ConsumableType Attribute Values.
<i>RegistrationRibbon</i>	Deprecated	Removed from <i>MiscConsumable/@ConsumableType</i> .	▶ Table 8.177 ConsumableType Attribute Values.
<i>Strap</i>	New	Added to <i>MiscConsumable/@ConsumableType</i> .	▶ Table 8.177 ConsumableType Attribute Values.
<i>Thread</i>	New	Added to <i>MiscConsumable/@ConsumableType</i> .	▶ Table 8.177 ConsumableType Attribute Values.
<i>NaturalLang</i>	New	Added to <i>NodeInfo</i> .	▶ Table 8.178 NodeInfo Resource.
<i>BusinessInfo</i>	Deprecated	Removed from <i>NodeInfo</i> .	▶ Table 8.178 NodeInfo Resource.
<i>GangSource</i>	New	Added to <i>NodeInfo</i> .	▶ Table 8.178 NodeInfo Resource.
<i>NotificationFilter</i>	Deprecated	Removed from <i>NodeInfo</i> .	▶ Table 8.178 NodeInfo Resource.
<i>OCGControl</i>	New	Added to <i>PageList/PageData</i> .	▶ Table 8.181 PageData Element.
<i>FontParams</i>	Deprecated	Removed from <i>PDLCreationParams</i> .	▶ Table 8.186 PDLCreationParams Resource.
<i>FileSpec</i>	New	Added to <i>QualityControlParams</i> .	▶ Table 8.224 QualityControlParams Resource.
<i>End</i>	New	Added to <i>QualityControlResult</i> .	▶ Table 8.226 QualityControlResult Resource.
<i>Start</i>	New	Added to <i>QualityControlResult</i> .	▶ Table 8.226 QualityControlResult Resource.
<i>FinishedPages</i>	New	Added to <i>RunList</i> .	▶ Table 8.240 RunList Resource.
<i>SealingTemperature</i>	New	Added to <i>SpinePreparationParams</i> .	▶ Table 8.257 SpinePreparationParams Resource.
<i>SealingTemperature</i>	Deprecated	Removed from <i>ThreadSealingParams</i> .	▶ Table 8.271 ThreadSealingParams Resource.
<i>Sealing</i>	Deprecated	Removed from <i>ThreadSewingParams</i> .	▶ Table 8.272 ThreadSewingParams Resource.
<i>Shape</i>	Modified	New values added in <i>WireCombBindingParams</i> .	▶ Table 8.291 WireCombBindingParams Resource.

Appendix N

Table N.1: Release notes for JDF 1.6 (Sheet 6 of 9)

ITEM	ACTION	DESCRIPTION	LOCATION
SingleCalendar	New	New value added to WireCombBindingParams/@Shape .	▶ Table 8.291 WireCombBindingParams Resource.
TwinCalendar	New	New value added to WireCombBindingParams/@Shape .	▶ Table 8.291 WireCombBindingParams Resource.
AddressUsage	New	Added to Address .	▶ Table 9.1 Address Element.
AddressLine	New	Added to Address .	▶ Table 9.1 Address Element.
Certification	New	New subelement.	▶ Table 9.7 Certification Element.
SourceObjects	Modified	Modified enumerations in ColorCorrectionOp .	▶ Table 9.9 ColorCorrectionOp Element.
SourceObjects	Modified	Modified enumerations in ColorSpaceConversionOp .	▶ Table 9.9 ColorCorrectionOp Element.
FileSpec (AbstractProfile)	Deprecated	Removed from ColorSpaceConversionOp .	▶ Table 9.9 ColorCorrectionOp Element
PresonalID	New	Added to Comment .	▶ Table 9.14 Comment Element.
RelativeTravel	Deprecated	Removed from Crease .	▶ Table 9.17 Crease Element.
Travel	Deprecated	Removed from Crease .	▶ Table 9.17 Crease Element.
Stacks	Deprecated	Removed from Disjointing/@OffsetUnits .	▶ Table 9.22 Disjointing Element.
GangSource	New	New subelement.	▶ Table 9.26 GangSource Element.
Reinforcement	New	Added to Hole .	▶ Table 9.29 Hole Element.
SourceObjects	Modified	Modified enumerations in ObjectResolution .	▶ Table 9.40 ObjectResolution Element.
ProcStepsGroup	New	Added to OCGControl .	▶ Table 9.41 OCGControl Element.
ProcStepsType	New	Added to OCGControl .	▶ Table 9.41 OCGControl Element.
SourceObjects	New	Modified enumerations in ScreenSelector .	▶ Table 9.46 ScreenSelector Element.
Required	Deprecated	Removed from Abstract State Element .	▶ Table 10.10 Abstract State Element.
date	Deprecated	Removed data type.	▶ Appendix A.2.3 date.
gYearMonth	Deprecated	Removed data type.	▶ Appendix A.2.14 gYearMonth.
AdhesiveNote	New	Enumeration added to ▶ BindingType.	▶ Table A.9 BindingType Enumeration Values.
CombBinding	New	Enumeration added to ▶ BindingType.	▶ Table A.9 BindingType Enumeration Values.
LooseBinding	New	Enumeration added to ▶ BindingType.	▶ Table A.9 BindingType Enumeration Values.
Both	Deprecated	Enumeration removed from ▶ MediaDirection.	▶ Table A.33 MediaDirection Enumeration Values.

Table N.1: Release notes for JDF 1.6 (Sheet 7 of 9)

ITEM	ACTION	DESCRIPTION	LOCATION
Estimate	New	Enumeration added to ▶ Scope.	▶ Table A.47 Scope Enumeration Values.
Job	New	Enumeration added to ▶ Scope.	▶ Table A.47 Scope Enumeration Values.
WorkAndTwist	Deprecated	Removed enumeration value from ▶ WorkStyle.	▶ Table A.62 WorkStyle Enumeration Values.
Employee	New	Value added to ▶ Content Types.	▶ Table A.65 Contact Types.
Recipient	New	Value added to ▶ Content Types.	▶ Table A.65 Contact Types.
SenderAlias	New	Value added to ▶ Content Types.	▶ Table A.65 Contact Types.
Controller	New	Value added to ▶ Device Classes.	▶ Table A.68 Device Classes.
DullUV	Deprecated	Value removed from ▶ Ink and Varnish Coatings.	▶ Table A.70 Ink and Varnish Coatings.
DullVarnish	Deprecated	Value removed from ▶ Ink and Varnish Coatings.	▶ Table A.70 Ink and Varnish Coatings.
Gloss	New	Value added to ▶ Ink and Varnish Coatings.	▶ Table A.70 Ink and Varnish Coatings.
GlossUV	Deprecated	Value removed from ▶ Ink and Varnish Coatings.	▶ Table A.70 Ink and Varnish Coatings.
GlossVarnish	Deprecated	Value removed from ▶ Ink and Varnish Coatings.	▶ Table A.70 Ink and Varnish Coatings.
Ink	New	Value added to ▶ Ink and Varnish Coatings.	▶ Table A.70 Ink and Varnish Coatings.
InkJet	New	Value added to ▶ Ink and Varnish Coatings.	▶ Table A.70 Ink and Varnish Coatings.
Latex	New	Value added to ▶ Ink and Varnish Coatings.	▶ Table A.70 Ink and Varnish Coatings.
Matte	New	Value added to ▶ Ink and Varnish Coatings.	▶ Table A.70 Ink and Varnish Coatings.
Primer	New	Value added to ▶ Ink and Varnish Coatings.	▶ Table A.70 Ink and Varnish Coatings.
Protective	Deprecated	Value removed from ▶ Ink and Varnish Coatings.	▶ Table A.70 Ink and Varnish Coatings.
Relief	New	Value added to ▶ Ink and Varnish Coatings.	▶ Table A.70 Ink and Varnish Coatings.
RubResistant	New	Value added to ▶ Ink and Varnish Coatings.	▶ Table A.70 Ink and Varnish Coatings.
Satin	New	Value added to ▶ Ink and Varnish Coatings.	▶ Table A.70 Ink and Varnish Coatings.
SatinUV	Deprecated	Value removed from ▶ Ink and Varnish Coatings.	▶ Table A.70 Ink and Varnish Coatings.
SatinVarnish	Deprecated	Value removed from ▶ Ink and Varnish Coatings.	▶ Table A.70 Ink and Varnish Coatings.
Toner	New	Value added to ▶ Ink and Varnish Coatings.	▶ Table A.70 Ink and Varnish Coatings.
WaterResistant	New	Value added to ▶ Ink and Varnish Coatings.	▶ Table A.70 Ink and Varnish Coatings.

Table N.1: Release notes for JDF 1.6 (Sheet 8 of 9)

ITEM	ACTION	DESCRIPTION	LOCATION
Cloth	New	Value added to ▶ MediaType Details.	▶ Table A.72 MediaType Details.
EnvelopeWindowLeft	New	Value added to ▶ MediaType Details.	▶ Table A.72 MediaType Details.
EnvelopeWindowRight	New	Value added to ▶ MediaType Details.	▶ Table A.72 MediaType Details.
Leather	New	Value added to ▶ MediaType Details.	▶ Table A.72 MediaType Details.
Booklet	New	Value added to ▶ Product Types.	▶ Table A.95 Product Types.
CoverLetter	New	Value added to ▶ Product Types.	▶ Table A.95 Product Types.
Envelope	New	Value added to ▶ Product Types.	▶ Table A.95 Product Types.
Leaflet	New	Value added to ▶ Product Types.	▶ Table A.95 Product Types.
Letter	New	Value added to ▶ Product Types.	▶ Table A.95 Product Types.
Map	New	Value added to ▶ Product Types.	▶ Table A.95 Product Types.
Media	New	Value added to ▶ Product Types.	▶ Table A.95 Product Types.
Notebook	New	Value added to ▶ Product Types.	▶ Table A.95 Product Types.
Postcard	New	Value added to ▶ Product Types.	▶ Table A.95 Product Types.
Proof	New	Value added to ▶ Product Types.	▶ Table A.95 Product Types.
ResponseCard	New	Value added to ▶ Product Types.	▶ Table A.95 Product Types.
Section	New	Value added to ▶ Product Types.	▶ Table A.95 Product Types.
SelfMailer	New	Value added to ▶ Product Types.	▶ Table A.95 Product Types.
Spine	New	Value added to ▶ Product Types.	▶ Table A.95 Product Types.
WrapAroundCover	New	Value added to ▶ Product Types.	▶ Table A.95 Product Types.
Sealing	New	Value added to ▶ Spine Operations.	▶ Table A.97 Spine Operations.
Glossy	New	Value added to ▶ Texture.	▶ Table A.101 Texture.
IPP:Course	New	Value added to ▶ Texture.	▶ Table A.101 Texture.
IPP:Fine	New	Value added to ▶ Texture.	▶ Table A.101 Texture.
IPP:Medium	New	Value added to ▶ Texture.	▶ Table A.101 Texture.
Matte	New	Value added to ▶ Texture.	▶ Table A.101 Texture.
kWh	New	Value added to ▶ Units.	▶ Table A.102 Units.
m3	New	Value added to ▶ Units.	▶ Table A.102 Units.
205	New	Code added to ▶ Appendix C Return Values.	▶ Table C.1 Return codes for JMF .
ActualAmount	New	Code added to ▶ Appendix H String Generation.	▶ Table H.1 Predefined variables used in @XXXTemplate.
all	Deprecated	Code removed from ▶ Appendix H String Generation.	▶ Table H.1 Predefined variables used in @XXXTemplate.

Table N.1: Release notes for JDF 1.6 (Sheet 9 of 9)

ITEM	ACTION	DESCRIPTION	LOCATION
CustomerName	New	Code added to ▶ Appendix H String Generation.	▶ Table H.1 Predefined variables used in @XXXTemplate.
element	Deprecated	Code removed from ▶ Appendix H String Generation.	▶ Table H.1 Predefined variables used in @XXXTemplate.
i	Deprecated	Code removed from ▶ Appendix H String Generation.	▶ Table H.1 Predefined variables used in @XXXTemplate.
JobRecipientName	Deprecated	Code removed from ▶ Appendix H String Generation.	▶ Table H.1 Predefined variables used in @XXXTemplate.
JobSubmitterName	Deprecated	Code removed from ▶ Appendix H String Generation.	▶ Table H.1 Predefined variables used in @XXXTemplate.
MediaType	Deprecated	Code removed from ▶ Appendix H String Generation.	▶ Table H.1 Predefined variables used in @XXXTemplate.
page	Deprecated	Code removed from ▶ Appendix H String Generation.	▶ Table H.1 Predefined variables used in @XXXTemplate.
r	Deprecated	Code removed from ▶ Appendix H String Generation.	▶ Table H.1 Predefined variables used in @XXXTemplate.
ri	Deprecated	Code removed from ▶ Appendix H String Generation.	▶ Table H.1 Predefined variables used in @XXXTemplate.
SheetNum	Deprecated	Code removed from ▶ Appendix H String Generation.	▶ Table H.1 Predefined variables used in @XXXTemplate.
SystemRoot	Deprecated	Code removed from ▶ Appendix H String Generation.	▶ Table H.1 Predefined variables used in @XXXTemplate.

CIP4



ORGANIZATION

INTEGRATION THROUGH COOPERATION



HEIDELBERG



Kodak



RICOH



cip4.org